

ULTIMATE BEHAVIOUR OF COMPOSITE FLOOR SLABS AT AMBIENT AND ELEVATED TEMPERATURE

K.A. CASHELL¹, A.Y. ELGHAZOULI² and B.A. IZZUDDIN³

ABSTRACT

This paper is concerned with the ultimate behaviour of composite floor slabs under extreme loading situations resembling those occurring during severe building fires. The study focuses on the failure state associated with rupture of the reinforcement in idealised slab elements, which become lightly reinforced in a fire situation due to the early loss of the steel deck. The paper summarises recent studies carried out in order to provide a fundamental approach for assessing the failure limit associated with reinforcement fracture in lightly reinforced beams, representing idealised slab strips. In addition, preliminary results from the first phase of ambient tests on isolated strips are outlined and the main conclusions are discussed. Following the completion of subsequent stages of experiments involving full slab members, this work will enable validation of detailed numerical models which will be used for developing simplified design-oriented guidance.

1. INTRODUCTION

The structural fire performance of buildings with composite steel-concrete floors has been the subject of extensive research investigations in recent years, e.g. [1-7]. These studies have identified the crucial role played by the composite floor slab in carrying the gravity loading within the fire compartment after the loss of strength in the supporting secondary steel beams due to elevated temperature. Although the slab exhibits significantly lower bending capacity, the development of tensile membrane action coupled with several sources of over-design leads to considerable fire resistance capabilities. To this end, progress in the development of improved design approaches needs to be based on detailed assessment of the behaviour of floor slabs, using reliable and realistic modelling approaches coupled with the application of appropriate failure criteria.

¹ Dept. of Civil & Environmental Engineering, Imperial College London, e-mail: k.cashell@imperial.ac.uk

² Dept. of Civil & Environmental Engineering, Imperial College London, e-mail: a.elghazouli@imperial.ac.uk

³ Dept. of Civil & Environmental Engineering, Imperial College London, e-mail: b.izzuddin@imperial.ac.uk

One of the most important failure criteria in a composite slab is that related to rupture of the reinforcement. Under fire conditions, the thin steel deck within a composite slab develops high temperature and becomes largely ineffective at an early stage. As a result, the slab behaves primarily as a concrete element with light mesh reinforcement. Prediction of the displacement and load levels corresponding to the fracture of the reinforcement is however a complex issue that necessitates a detailed treatment of the interaction between the concrete material and steel reinforcement, with due account of the appropriate loading and boundary conditions. Due to the uncertainties involved in various important material and response parameters, this problem also requires experimental validation and calibration.

This paper provides an overview of recent studies carried out to examine the performance of floor slabs. Analytical models developed to represent the ultimate behaviour of lightly reinforced beams at ambient and elevated temperature are outlined; these formed the basis of more detailed treatment of full slabs. Selected results from the first set of validation tests, conducted on isolated reinforced concrete beams representing idealised slab strips are presented and preliminary findings are discussed. Further tests on more realistic slab representations are currently underway which, in conjunction with numerical investigations, will be used to carry out design-oriented studies.

2. ANALYTICAL MODELS

2.1 Structural Configuration

A typical composite slab, of the form shown in *Fig. 1*, is normally supported by secondary steel beams acting compositely with the slab through shear connectors. The conventional design procedure is to treat the short direction of the slab as well as the secondary and primary beams as one-dimensional members supporting the load from the floor. The gravity loading considered in an accidental fire situation typically consists of the unfactored dead load and a proportion of the imposed load. Depending on the extent of fire spread within compartments as well as the degree of fire protection, some of the steel beams as well as the thin steel deck develop high temperature and become largely ineffective at an early stage. As a result, the slab behaves primarily as a concrete element with light mesh reinforcement, which is required to span over the ineffective steel beams and hence sustain the gravity load from a larger floor area than that intended by design.

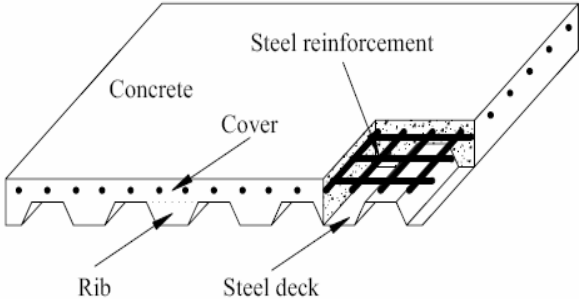

Fig. 1 – Typical configuration of composite profiled slabs

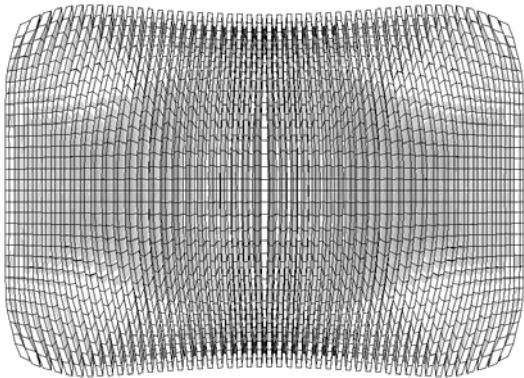

Fig. 2 – Numerical simulation of full-depth crack (magnified deformation) [9]

Although the flexural capacity of the slab is significantly reduced due to the loss of the steel deck, it is still able to provide considerable fire resistance. This is contributed to by several aspects of floor over-design caused by the idealisation of the member behaviour and support conditions. Most importantly, the slab is usually able to develop tensile membrane action, which significantly increases the load-carrying capacity. The existence of considerable planar restraint in most situations has been demonstrated in earlier studies, e.g. [6]. In an internal compartment, this is effectively provided by the surrounding cooler structure. On the other hand, in edge compartments, the perimeter beams retain significant stiffness due to their relatively lower temperatures. Besides, the development of a compressive ring in the slab with the presence of adequate reinforcement anchorage contributes to the provision of a degree of planar restraint.

2.2 Failure Conditions

In the absence of the steel deck, simulating deck integration at elevated temperature, failure occurs by fracture of the reinforcement across a localised through-depth crack. This is illustrated in Fig.2 based on analysis carried out adopting a recently-developed numerical model [8,9] for simulating the response of orthotropic slabs, using computationally efficient shell elements that retain the accuracy of solid representations. This localisation is primarily due to the fact that the only available reinforcement is a nominal steel mesh, which is rather light and hence unable to generate further significant cracks within the concrete, thus leading to high strain concentrations within the steel. In order to take this failure criterion into consideration, it is important to determine the levels of deformation that may safely be sustained by the lightly reinforced floor slab. A conventional smeared crack approach provides good predictions of the load-deflection response of lightly reinforced structures, but cannot assess reliably the strain concentrations across cracks, since such concentrations would be unrealistically dependent on the element size instead of the geometric and material characteristics of the structure.

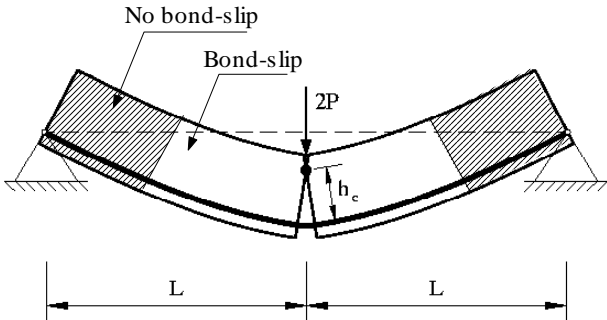

Fig. 3 – Layout of lightly reinforced member indicating bond-slip regions [10]

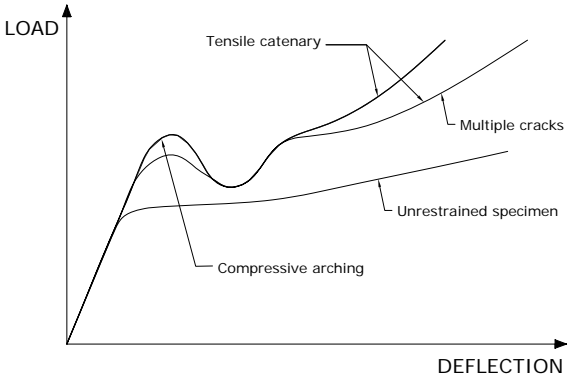

Fig. 4 – Behaviour of reinforced concrete members under various restraint conditions

A fundamental step towards quantifying the failure of lightly reinforced members under ambient and fire conditions has been recently proposed [10] through a simplified model of restrained lightly reinforced concrete members, simulating composite slab strips. The model represents the post-cracking behaviour of an axially restrained member subject to mid-span loading, as shown in Fig. 3. A single layer of reinforcement is located at a prescribed depth, and the centre of rotation is user-defined but typically assumed to be at the top concrete

fibre. Under fire conditions, the temperature distribution over the cross-section is assumed to be linear, but no variation over the length is considered. Depending on the combination of loading, geometry and material properties, the length L consists of two regions, namely the 'bond-slip' and the 'no bond-slip' region', as indicated in Fig. 3. By incorporating the full stress-strain relationship for the steel reinforcement and appropriate properties for concrete, as well as bond strength between the steel and concrete, the load-displacement response of the member can be determined for a given temperature distribution. Most importantly, the deformation and load levels corresponding to the attainment of an ultimate strain limit in the steel can be obtained, hence providing a prediction of the failure limit associated with reinforcement fracture.

Although the model focuses on the tensile membrane behaviour in axially-restrained members as illustrated in Fig. 4, through minor modifications it can also predict the failure displacement and corresponding capacity for other loading, boundary and response conditions. The model has been used to investigate the factors influencing fracture of light reinforcement [11]. For example, Figs. 5 and 6 show representative behaviour of the response at ambient and elevated temperature. The member in this case has a span of 3 m (i.e. $L=1.5$ m according to Fig 3), depth of 60 mm and width of 200 mm. The reinforcement ratio is assumed as 0.25% and located at mid-depth. The ultimate strength of the reinforcement is 600 N/mm^2 and the concrete strength is 40 N/mm^2 . In Fig. 6, the temperatures are varied at the bottom of the member, whilst the top remains at ambient.

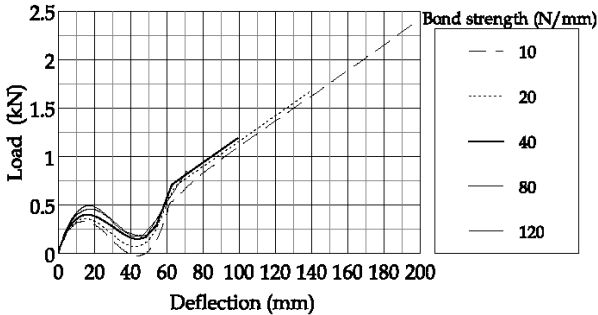

Fig. 5 – Effect of bond strength on response and failure limit at ambient temperature [11]

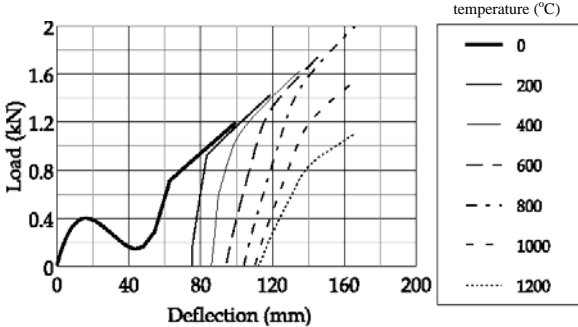

Fig. 6 – Influence of temperature on response of lightly reinforced member [11]

As expected, in addition to a number of important geometric and material characteristics, the bond strength between the steel reinforcement and concrete plays a major role in determining the failure displacement. Furthermore, it has been shown that elevated temperature increases the failure deflection, which is attributed mainly to thermal expansion effects. However, elevated temperature can also have a negative influence on the failure deflection when it leads to a significant thermal gradient over the depth of the member [10,11].

The models for isolated reinforced concrete strips were more recently extended [12,13] to represent slabs of various levels of reinforcement and restraint under ambient and elevated temperature conditions. The approach used for the slab models at elevated temperature differs from that in the beam models in that the underlying shape of the various slab parts is described in three dimensions. The procedure utilises an assumed thermal strain field which captures reasonably well the influence of thermal curvature. Importantly, individual strips within a slab represent fundamental components within the full slab models. Consequently, understanding and validating the behaviour of isolated strips represents a necessary step which would be followed by experimental examination of full slab components.

3. EXPERIMENTAL RESPONSE

The primary objective of the laboratory experiments is to gain a greater understanding of the ultimate behaviour of composite slabs and to provide the necessary information to validate appropriate failure criteria. As noted before, a number of material properties, including the bond-slip characteristics, have a direct influence on the ultimate performance. In order to provide validation for detailed numerical models and simplified analytical approaches, the experimental investigation are planned in stages, starting from material tests, followed by isolated strip tests, and will subsequently be complemented by full slab tests. The tests are carried out at ambient temperature, but simulating one aspect of elevated temperature conditions through the absence of the steel deck. Hereafter, a brief description of selected material and strip tests is presented, and important observations are highlighted.

3.1 Material Characteristics

Several types of reinforcement bars with different properties were considered in the experimental investigation in order to ascertain the behaviour under various conditions. Plain, ribbed and mesh reinforcement were examined in order to provide a range of characteristics and assess their influence on the member response. The yield, or proof, strength of the reinforcement bars varied between under 250 N/mm^2 to over 550 N/mm^2 , with a corresponding ultimate strength between 300 N/mm^2 and over 600 N/mm^2 . On the other hand, the ultimate strain exhibited by the reinforcement at fracture varied between low values of about 4% to as high as 20% in some bars. Careful attention was given to using equipment that can provide the full stress-strain relationship of the reinforcement bars up to fracture, as the actual shape of the curve can have a significant influence on the behaviour. On the other hand, an average compressive concrete strength of about 40 N/mm^2 was considered in most of the tests.

As noted before, in addition to other material properties, the bond between the reinforcement bars and concrete plays a key role in determining the failure limit of the members. Accordingly, it is important to assess the bond characteristics for the reinforcement used in the tests. There are several possible techniques for bond tests, with the most common being pull-out testing and beam approaches. In selecting the most appropriate test method, consideration should be given to the actual conditions prevailing in the member. However, replicating the exact bond conditions present in a member within a simple testing technique may not be possible. Consequently, to enable a large number of material tests to be conducted, conventional pull-out bond tests were initially adopted to provide the same basis for comparing the relative bond characteristics of various reinforcement bars. Several modifications were made to the typical pull-out test set-up in order to improve the representation of the realistic loading and confinement conditions in a member. Nevertheless, whilst the pull-out tests provide useful information as a comparative measure of bond characteristics, the actual bond characteristics can be more directly obtained from large-scale beam tests, which for comparison were also carried out as part of this investigation for selected cases.

The influence of a number of parameters was examined within the study of bond-slip behaviour. These included the type and diameter of reinforcement, concrete mix, bond length, concrete cover, amongst other properties. As expected, the type of reinforcement had a direct influence on the bond strength. This is illustrated in the example of bond-slip response shown in Fig. 7 for deformed (B1) and plain (B2) bars of the same diameter.

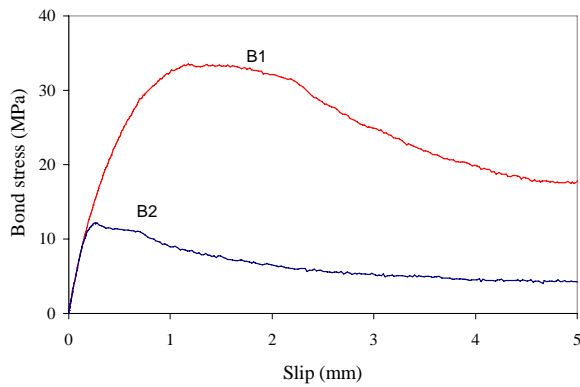

Fig. 7 – Influence of bar type on bond-slip

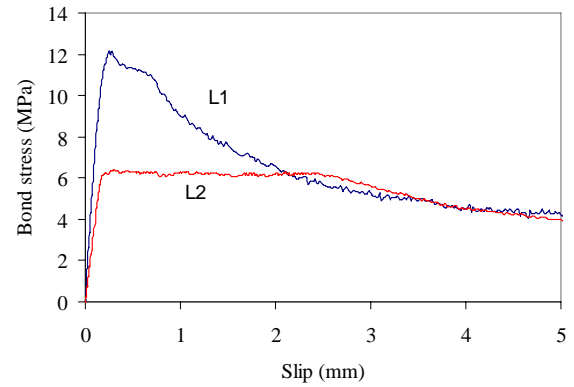

Fig. 8 – Influence of length on bond-slip

The bond embedment length and concrete cover to the reinforcement also had a significant effect on the bond-slip characteristics. For example, Fig. 8 shows the response obtained from two pull-out tests with different embedment lengths L1 and L2 corresponding to 5 and 10 multiples of the bar diameter, respectively. On the other hand, Fig. 9 illustrates the behaviour for specimens with different concrete covers C1 and C2, corresponding in this case to about 75 and 20 mm, respectively. The type of bond failure can also vary between pull-out and splitting behaviour, depending on both the type of reinforcement and the concrete cover. Whilst in pull-out behaviour, some residual bond strength is normally present, in the case of splitting failure the residual bond diminishes with increasing values of slip.

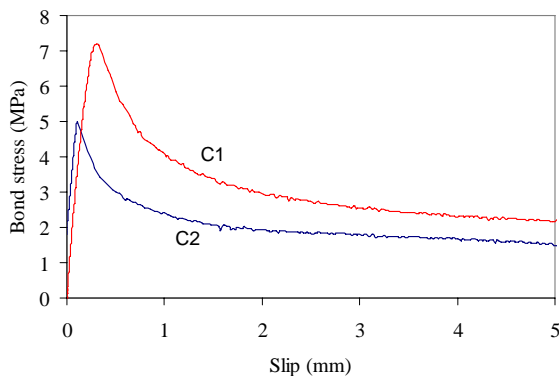

Fig. 9 – Effect of concrete cover

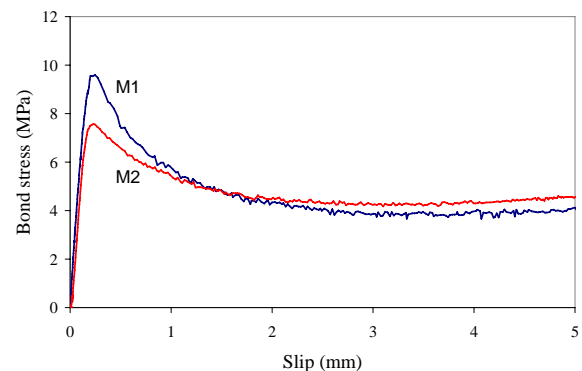

Fig. 10 – Effect of different concrete mixes

Fig. 10 highlights the effect of concrete type on the behaviour, where M1 and M2 represent normal-weight and light-weight concrete respectively. The type of aggregate used in the concrete appeared to have a minor influence on the bond behaviour and mechanisms, in comparison with other parameters, although the peak bond stress was marginally higher for normal-weight concrete.

3.2 Idealised Member Tests

In order to examine the ultimate behaviour of members representing isolated strips of slabs, an experimental arrangement which enables testing of axially restrained specimens was constructed. The arrangement used for the test rig is shown in Fig. 11 and a view of the test set up is shown in Fig. 12. The specimens were rotationally unrestrained, but the axial restraint was varied between conditions related to restraint from pull-in only, axial expansion, or both. Conditions related to full axial restraint was simulated by clamping the ends of the

specimen within stiff plates which were then connected to an arrangement of bearings. Loading was applied at the middle of the specimen through closely spaced points to simulate concentrated mid-span loading. A hydraulic actuator, operating in displacement-control, was used for applying the loading. In each test, the displacement was increased gradually until failure was reached by fracture of the reinforcement, which was typically accompanied by a significant reduction in the load carrying capacity.

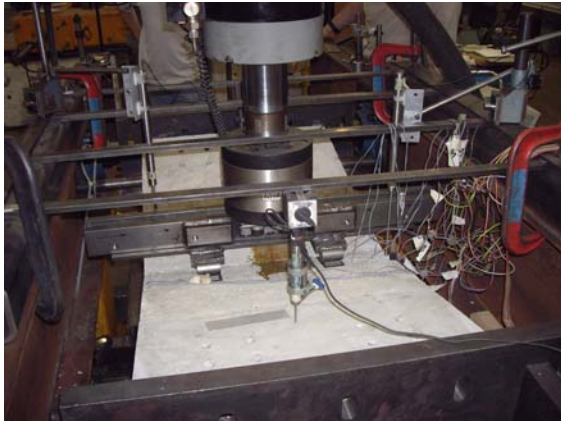
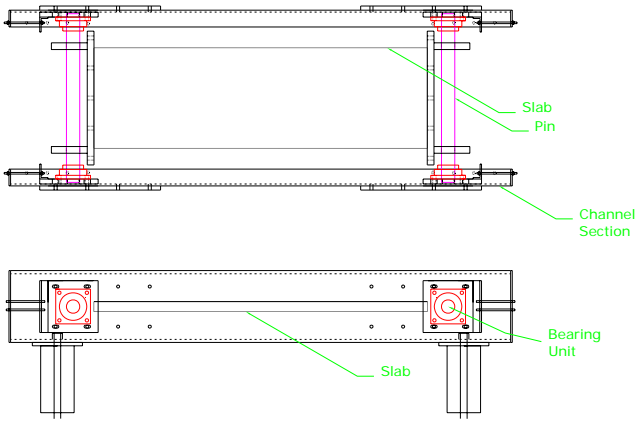

Fig. 11 – General arrangement of test rig

Fig. 12 – View of test set up

The first phase of experiments included tests on specimens with various reinforcement configurations, as discussed before, and employing a number of variations in the loading and boundary conditions. Tests were carried out on members with both flat and ribbed profiles simulating composite slab configurations. The reinforcement ratio was varied between around 0.2% to 1.2%., and the range of material properties for the reinforcement bars was as described in the previous section.

A large amount of data was obtained through the measurements of displacements, loads and strains in the tests. However, emphasis is placed herein on the deformation at failure of the specimen which corresponds to fracture of the reinforcing bars. Typical examples of the overall load-displacement response obtained are given in Figs 13 to 16 below.

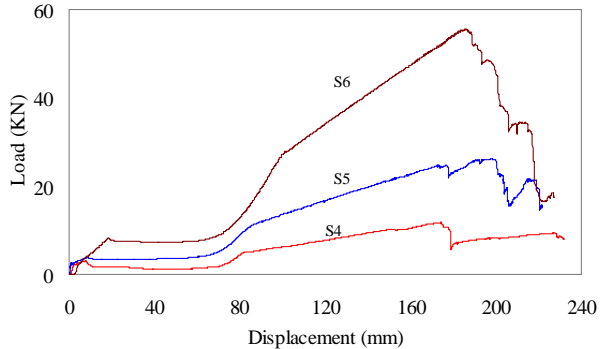
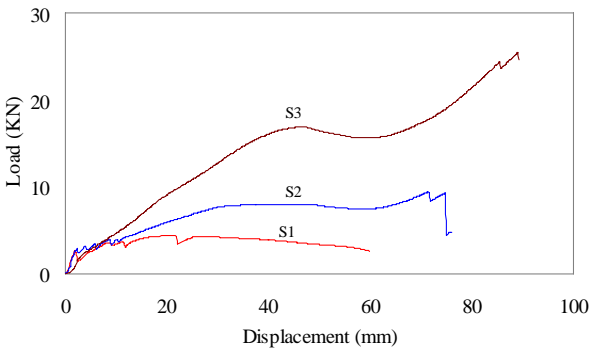

Fig. 13 – Members with deformed bars

Fig. 14 – Specimens with plain bars

Fig. 13 illustrates the response of three members utilising identical deformed bars but with varying reinforcement ratios of 0.24%, 0.52% and 1.2% for strips S1, S2 and S3, respectively. The specimens had an overall span of 1.5 m; they were rotationally unrestrained but restrained from pull-in deformations, hence able to develop tensile membrane action. In

this case, the specimens with higher reinforcement ratios developed multiple cracks which resulted in an increase in the deformation corresponding to failure.

The overall response from corresponding tests with specimens utilising plain reinforcing bars is demonstrated in Fig. 14. Again, the three specimens S4, S5 and S6 have reinforcement ratios of 0.24%, 0.52% and 1.2%. In this case, significantly more ductile behaviour was obtained, as expected. Moreover, due to the relatively low bond, multiple cracking did not occur, resulting in broadly the same failure displacement in all three specimens. Despite the lower yield capacity of these three specimens, the ability to develop considerable membrane action resulted in higher overall load-carrying capacity compared to the specimens with the deformed bars.

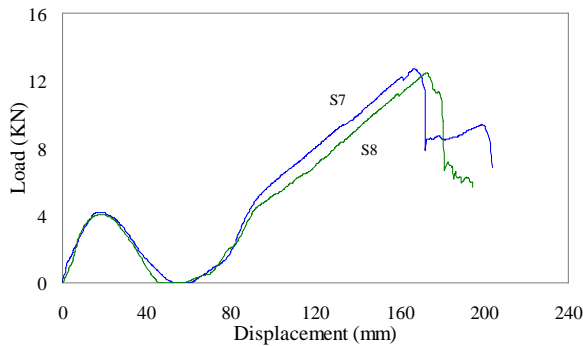

Fig. 15 – Compressive membrane action

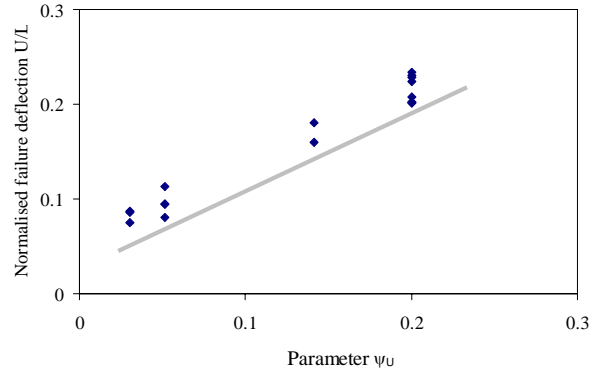

Fig. 16 – Vertical deflection at failure

Fig. 15 on the other hand illustrates the response when an effective restraint enabling compressive membrane action to occur is provided. In this case, the response is shown for two specimens, S7 and S8 with plain bars and a reinforcement ratio of 0.23% but with different cross-section dimensions. In comparison with the plots in Fig. 14, whilst the initial response is markedly different, it subsequently behaves in the same manner within the tensile membrane range, attaining a similar failure deformation level.

In general, whilst the load-deflection response can be predicted through numerical and analytical models adopting smeared cracking approaches, the displacement at failure is more difficult to assess due to its dependence on a number of inter-related parameters.

As expected, the failure deflection was closely related to a number of important parameters, including: the ultimate strain of the reinforcement (ϵ_{um}); the bond strength per unit length (σ_b) between steel and concrete, the strain hardening properties of the reinforcement, which can be represented through the difference between the ultimate strength (σ_u) and proof ($\sigma_{0.2}$) or yield stress of steel, the reinforcement cross-sectional area (A_s); and the length (L). Both the results of the analytical assessments [10,11] and the findings from the experimental observations, point towards a direct relationship between the failure deflection (U), normalised by the length L , and a parameter ψ_U , which captures the combined influence of the above-noted parameters, such that:

$$\psi_U = \sqrt{\frac{A_s(\sigma_u - \sigma_{0.2})}{\sigma_b L}} \epsilon_{um} \quad (1)$$

The above parameter is based on the assumption that a single crack would occur at mid-span of the member, which is characteristic of members with relatively light reinforcement. Accordingly, the accuracy of this expression depends on the reinforcement ratio within the member, as it would tend to underestimate the failure deflection if multiple

cracking occurs with increasing steel ratios. This aspect of behaviour was also observed in the experimental investigation where, depending on the type of bars used, several members with reinforcement ratios exceeding 0.5% exhibited multiple cracking which had a direct influence on enhancing the failure deflection. Fig. 16 depicts the normalised failure deflection (U/L) obtained from the tests as a function of the parameter ψ_U . Equation (1) above provides a lower bound prediction of the failure displacement, hence representing a reasonable failure criterion for this type of member.

The above treatment has been extended to the response under elevated temperature [10,11]. It can be shown that the parameters given in Equation (1) above can also be used to predict the failure displacement through the following relationship:

$$U = \sqrt{2L \left(\frac{A_s(\sigma_u - \sigma_{0.2})}{3\sigma_b} \varepsilon_{um} + \alpha t_s L - \frac{(\alpha \nabla t)^2 L^3}{24} \right)} \quad (2)$$

in which t_s is the temperature at the steel reinforcement and ∇t is temperature gradient in the cross-section; σ_b , σ_u , $\sigma_{0.2}$ and ε_{um} are the temperature-dependent material properties, and the coefficient of thermal expansion α can be conservatively considered as the lower of α_c and α_s of the concrete and steel, respectively, if they differ within normal ranges.

Equation (2) above illustrates that, in addition to the temperature related material properties, the thermal expansion and gradient have an influence on the failure displacement. Subject to further experimental validation under elevated temperature conditions, relationships of this form can be used as a basis for implementing appropriate failure criteria in design procedures.

4. CONCLUDING REMARKS

A brief description of recent studies into the ultimate behaviour of composite slabs under idealised fire conditions has been presented in this paper. The slabs are lightly reinforced following the loss of the steel deck; therefore particular attention is given to failure by fracture of the reinforcement. Emphasis is given to lightly reinforced beams, representing isolated slab strips. Based on analytical and experimental investigations, the influential parameters are described and a direct relationship is established between the failure displacement and a number of these parameters. Of particular importance are the steel stress-strain curve and the bond stress-slip characteristics. Examination of these relationships enables a realistic assessment of the ultimate behaviour.

The experimental program associated with this research is continuing presently with the testing of further slab strips and also full two-way reinforced slabs. Similarly to the previous phases, several parameters will be varied in these experiments such as the boundary conditions, specimen geometry and material properties.

Acknowledgments

The support provided by the Engineering and Physical Sciences Research Council (EPSRC) in the UK for the work described in this paper is gratefully acknowledged. The authors would also like to thank the technical staff of the structures laboratories at Imperial College London for their assistance with the experimental work.

REFERENCES

- [1] Wang, Y.C., Lennon, T., and Moore, D.B. “The behaviour of steel frames subject to fire”, *Journal of Constructional Steel Research*, 35, pp. 291–322, 1995.
- [2] Huang, Z., Burgess, I. W. and Plank, R. J. “Nonlinear analysis of reinforced concrete slabs subjected to fire”, *American Concrete Institute Structural Journal* 96(1), pp. 127–135, 1999.
- [3] Bailey, C.G. and Moore, D.B., “The structural behaviour of steel frames with composite floor slabs subject to fire. Part 1: Theory”, *The Structural Engineer*, 78(11), pp. 19–27, 2000.
- [4] Bailey, C.G. and Moore, D.B., “The structural behaviour of steel frames with composite floor slabs subject to fire. Part 2: Design”, *The Structural Engineer*, 78(11), pp. 28-33, 2000.
- [5] Gillie, M., Usmani, A.S., and Rotter, J.M. “A structural analysis of the first Cardington test”, *Journal of Constructional Steel Research*, 57, pp. 581-601, 2001.
- [6] Elghazouli, A. Y. and Izzuddin, B. A., “Analytical assessment of the structural performance of composite floors subject to compartment fires”, *Fire Safety Journal*, 36, pp. 769–793, 2001.
- [7] Lim, L., Buchanan, A. and Moss, P. “Experimental testing and numerical modelling of two-way concrete slabs under fire conditions”, *Journal of the Structural Engineering Society New Zealand, SESOC*, 12-26, 2003.
- [8] Izzuddin, B. A., Tao, X. Y. and Elghazouli, A. Y. Realistic modelling of composite and RC floors slabs under extreme loading – Part I: Analytical method”, *Journal of Structural Engineering, ASCE*, 130(12): 1972-1984, 2004.
- [9] Elghazouli, A. Y. and Izzuddin, B. A. “Realistic modelling of composite and RC floors slabs under extreme loading – Part II: Verification and Application”, *Journal of Structural Engineering, ASCE*, 130(12): 1985-1996, 2004.
- [10] Izzuddin, B. A. and Elghazouli, A. Y., “Failure of lightly reinforced concrete members under fire. I: Analytical modelling”, *Journal of Structural Engineering*, 130(1), pp. 3–17, 2004.
- [11] Elghazouli, A. Y. and Izzuddin, B. A., “Failure of lightly reinforced concrete members under fire. II: Parametric studies and design considerations”, *Journal of Structural Engineering*, 130(1), pp. 18–31, 2004.
- [12] Omer E., Failure of composite steel-concrete slabs under elevated temperatures, PhD Thesis, Imperial College London, 2006.
- [13] Omer E., Izzuddin B. A. and Elghazouli A. Y., “Failure assessment of simply supported floor Slabs under elevated temperature”, *Structural Engineering International*, 16(2), pp. 148-155, 2006.