

# Experimental Apparatus for the Study of micro Heat Exchangers with Inlet Temperatures between -200 and 200 °C and Elevated Pressures

Anatoly Parahovnik<sup>1,2</sup>, Nir Tzabar<sup>2</sup>, Gilad Yossifon<sup>3</sup>

<sup>1</sup> Faculty of Mechanical Engineering Technion-Israel Institute of Technology, Haifa Technion city 32000, Israel; Email:tolik@tx.technion.ac.il

<sup>2</sup> Rafael, Haifa, 3102102 Israel; Email:nirtz@rafael.co.il

<sup>3</sup> Faculty of Mechanical Engineering Technion-Israel Institute of Technology, Haifa Technion city 32000, Israel; Email:yossifon@technion.ac.il

**Abstract** The current paper presents a test bench for micro-fabricated Recuperative Counter Flow Heat Exchanger (RCFHE). The bench is suitable for up to 200 K difference between inlets temperatures and operating pressures up to 32 MPa. The experimental setup allows controlling the physical state of the gas (i.e. temperature, pressure and flow rate) at the RCFHE inlets. The bench has 5 controlled parameters and 5 more that are monitored and enables studying each of the hot and cold channels separately. We demonstrate a steady supply of liquid nitrogen into the device for 10 minutes without thermal insulation of the specimen. Another run is a steady state experiment with a temperature difference of about 20-30 K between inlets. These show that the apparatus is capable of characterizing heat exchangers and serve as preliminary results.

**Keywords:** Micro channels, Recuperative Heat Exchanger, Gas Micro Flow, MEMS

## 1. Introduction

Several microfluidic applications like cryogenic micro coolers [1,2] and cryosurgical probes use Joule-Thomson effect [3,4] for cooling. These devices include Recuperative Counter Flow Heat Exchangers (RCFHE) where a warm high pressure gas stream is cooled by a cold low pressure stream. In recent years, research on microfabricated RCFHEs is in progress to reduce existing RCFHEs dimensions and to increase their efficiency.

In conventional JT cryocoolers the RCFHEs are subjected to a large range of inlet conditions ~200 K in temperature difference and pressure differences up to 70 MPa. The presented test setup is intended to study planar RCFHE, produced by micro fabrication technique including deep reactive ion etching (DRIE) and anodic bonding, under conditions that simulate RCFHE during service time.

## 2. Test Bench design

### 2.1 Desired parameters

In order to define the intended test bench there is a need to first define the properties that need

to be controlled:

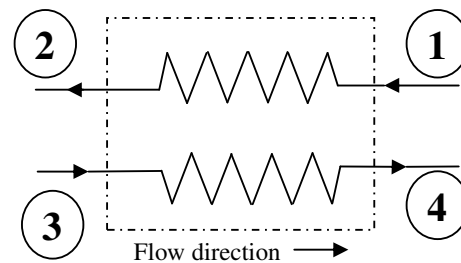

Figure 1-Schematic of a RCFHE. The numbers correspond to the different inlets/outlets.

Figure 1 describes the operation principle of Counter Flow Heat Exchanger. Point 1 is the hot gas inlet and point 3 is the inlet of the cold nitrogen gas that in some cases can be delivered in its liquid state. In order to obtain sufficient heat exchange between the two streams the system should be insulated from the environment. In microscale devices the flow rates are usually small, therefore, insulation is more critical. Gas properties vary at different working points and in order to define the thermodynamic state there is a need to monitor pressure and temperature at every

point. Furthermore, the inlets temperature, pressure, and flow rates have to be not just monitored but also controlled in order to be able to examine the RCFHE at different initial conditions.

by changing the flow rate of the drain channel. The cold stream exits the RCFHE at port 4. This channel also controlled by needle valve before the flow reaches mass flow meter. Table 1a summarizes all the experimental

port/ channel	Physical parameter	Parameter type and range		Sensor information	
		Controlled/ Monitored	Range	Sensor type	uncertainty
1	Temperature	Controlled	30-70 °C	EPRB-3	±0.5 K
1	Pressure	Controlled	0-7 Mpa	EPRB-3	0.06 MPa
2	Temperature	Monitored		EPRB-3	±0.5 K
2	Pressure	Monitored		EPRB-3	0.06 MPa
3	Temperature	Controlled	(-200)- Room Temp °C	RTD PT100	±1 K
3	Pressure	Monitored	Up to 0.2 Mpa	US300	0.02 MPa
4	Temperature	Monitored		EPRB-3	±0.5 K
4	Pressure	Monitored		EPRB-3	0.06 MPa
1-2	Mass flow	Controlled	0-2 SLPM	Alicat Mass flow meter	0.025 SLPM
3-4	Mass flow	Controlled	Defined by HE	Alicat Mass flow meter	0.025 SLPM

Table 1- List of parameters type and range and sensor information

## 2.2 Apparatus design

Port 1 is the RCFHE inlet. Pressurized nitrogen is supplied from a 10 Liters vessel, its pressure is reduced to the desired level by pressure regulator, and its temperature is controlled by a heating element consisting of a 50 cc. pressure vessel with electric heater wrapped around it and is insulated using glass fabric. Port 2 is the outlet of the warm stream in the RCFHE where the temperature, pressure are monitored the flow rate is defined by needle valve up stream.

The RCFHE receives its cold gas at port 3 which is supplied from a 25 Liters Dewar that sustains pressure of about 0.2 MPa. The temperature at this port needs to be controlled in order to deliver different inlet conditions to the examined RCFHE, which this is obtained

features whether they are sampled or governed and the intended monitored ranges. The ports number is consistent with points presented in. Ports 1, 2, 4 have EPRB-3 type sensor this probe combine pressure and temperature sensing elements it is produced by Measurement Specialties<sup>®</sup>. At port 3 temperature sensor was designed and produced at our facilities and use PT100. Pressure transducer that is mounted is US300 type sensor produced by Measurement Specialties<sup>®</sup>. Flow meters are 0-2.5 [SLPM] mass flow meters and were purchased from Alicat company<sup>®</sup>.

The setup is designed and tested for working fluids at pressures up to 32 MPa. The elements that connect between the gas supply lines and the RCFHE are made of 416L stainless steel in

order to withstand the desired pressure. The flow path of the low temperature gas starts at a 25 liter Liquid Nitrogen gas (LN<sub>2</sub>) Dewar goes through a pre-cooling element consisting of a tube and shell type heat exchanger. A junction splits the flow into two streams; one enters the studied RCFHE at port 3 while the other is a drain channel.

The cold stream leaves the RCFHE at port 4 and enters a needle valve that controls its mass flow afterwards the gas flow through mass flow meter. Scheme of the experimental setup is presented in fig 2a-2b. All the properties are recorder using Labview script and written to a TXT file at real time.

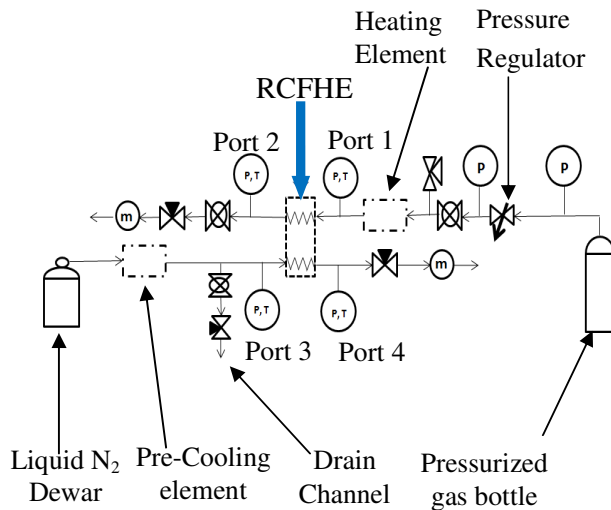

Figure 2a -scheme of the experimental test setup

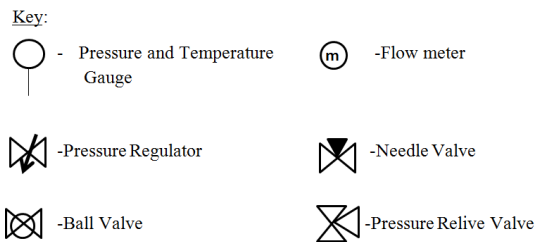

Figure 2b-key for symbols in Fig. 2a

### 3. RCFHE design

The first design that was studied is RCFHE made of straight channels. Although not optimal it is simple enough to be used as a test

model. The device, fig.3, is made of a silicon layer (1), consisting of fabricated microchannels, sandwiched between layers of Pyrex glasses (2,3) that are anodically bonded [5,6] to layer (1). The flow of the hot/cold streams inside the RCFHE is schematically presented in fig.4. The numbers of the inlets and outlets fit the ports presented in table 1.

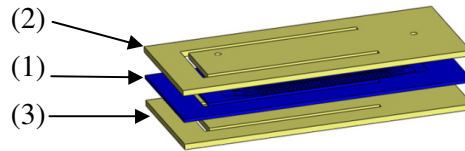

Figure 3-Heat Exchanger assembly

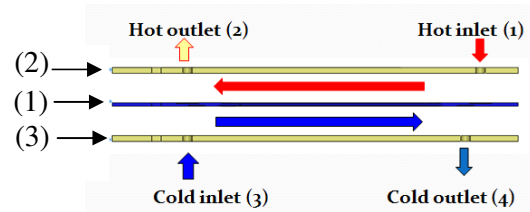

Figure 4-Flow scheme inside the HE

#### 3.1 Silicon layer design

Layer (1) of the RCFHE was constructed out of a 0.5 mm thick Si wafer, where etching was achieved using DRIE processes in three different stages. Channels 1-2 were etched on top of the wafer, channels 3-4 on the bottom, and a through etching was done in order to

#### Construction addition

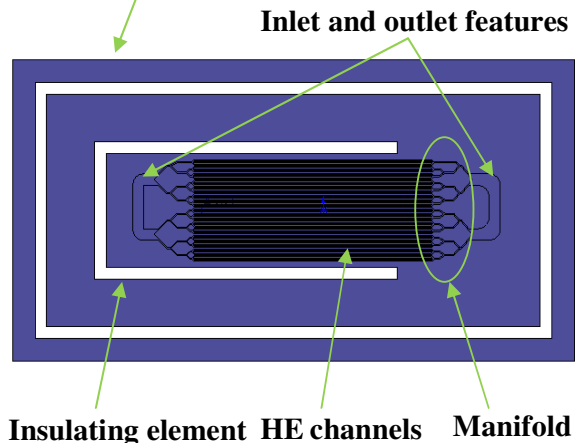

Figure 5-Silicon layer design

release the slide. The depth of the channels was aimed at 150  $\mu\text{m}$  in order to maintain its structural strength. The design patterned on layer (1) consists of different elements that are required for the operation of the RCFHE (see fig.5). The “insulating element” assures the thermal insulation of the channels. Its thickness is 1mm and it is an etch-through feature. The “construction addition” is needed for etch-through in order to release the device from the wafer with exactly the same production sequence as that of the insulating element.

All other elements are part of the flow path: fluid enters a manifold that distributes the flow to the RCFHE body and a similar manifold concentrates the stream to the outlet port. The manifolds consist of 4 stages where each stage is divided into 2 different branches which their lengths were defined using bio-mimetic principles [7,8]. Although the principles also define the width of the channels at each stage it is neglected in order to simplify the production. The main region where the streams exchange heat is a set of 24 mm long channels. The straight channels have a width and interchannel spacing of 100  $\mu\text{m}$  and aspect ratio (AR) of 1.

Leakage tests and flow profile characterization of RCFHE were performed for simplicity reasons using 4.8  $\mu\text{m}$  green fluorescent polymer microspheres (Thermo scientific), that were diluted to 0.02% volumetric concentration with deionized water (DI). The solution was then introduced into the HE at different flow rates with no leakage being detected.

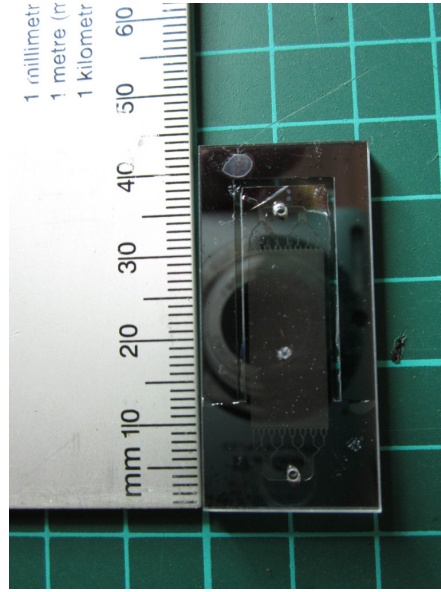

Figure 4- Assembled Heat Exchanger

### 3.2 Construction insights

#### *Glass-Metal contact and sealing:*

The standard materials that are used in microfabrication processes are silicon and glass which are fragile materials. Hence, negligible deformation is expected before they break when the applied forces reach the Ultimate Tensile Stress value. The fact that the RCFHE is made of fragile materials makes it more difficult to handle.

Direct contact between glass and metal may result in local loading that eventually lead to failure of the device. In order to deliver pressurized gas the system has to withstand high pressure level therefore the ports were made of steel. O-rings were used for sealing between the RCFHE and the ports. In addition, Teflon<sup>®</sup> pads were placed between the RCFHE and the ports to eliminate possible failures.

#### *Alignment between two sides:*

This issue is critical because of the RCFHE configuration.

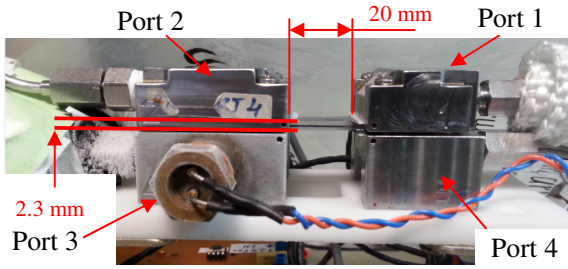

Figure 5-Testing bench with RCFHE

Fig. 7 shows that any misalignment between left and right side applies bending moment on the RCFHE and breaks it. Ports 3 and 4 were produced in a manner that their contact surfaces with the RCFHE will be at the same height. A 0.05 mm difference between these two surfaces was measured.

Another mechanism that introduces high loading into the device is the tubing as can be seen in fig.7. These tubes are made of stainless steel in order to function under the necessary pressure levels. These tubes introduce bending moments into the upper ports which affect the apparatus.

*Insulation of the delivering system:*

Typical flow rate of the presented RCFHE in line 3-4 is about 0.3-0.7 SLPM which is an extremely low flow rate. Therefore, the heat losses along the connecting line are crucial and a pre-cooling stage for the nitrogen and a drain channel were constructed.

Pre-cooling stage cools the nitrogen to liquefaction state and the drain channel keeps the flow levels high enough in order to deliver the nitrogen in a cold state to port 3.

**4. Preliminary Experiments**

The first experiment was conducted to examine the setup functionality while the second experiment demonstrated a full operational mode of the setup.

**4.1 Experiment with liquid nitrogen**

During this experiment (fig 8) LN<sub>2</sub> was obtained at port 3. This state is recorded for 10 minutes and then stopped due to flow reduction in the channel. It can be seen that when there is a two phase flow in the system there is a substantial pulsation in the ducts

which is caused by the phase change of the LN<sub>2</sub>. When the flow is reduced the temperature increases and the pulsations become smaller. Figure 9 presents the recorded pulsations.

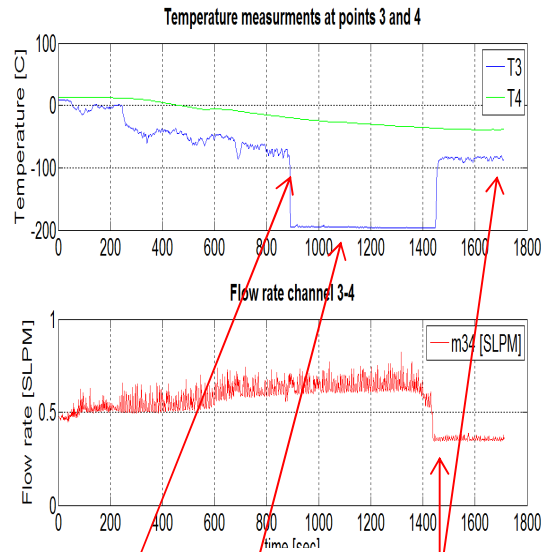

LN<sub>2</sub> enters HE, 15 minutes from start  
 It was stable for 10 minutes  
 Due to flow reduction temperature raised by about 100 K

Figure 6-LN<sub>2</sub> is obtained in the inlet

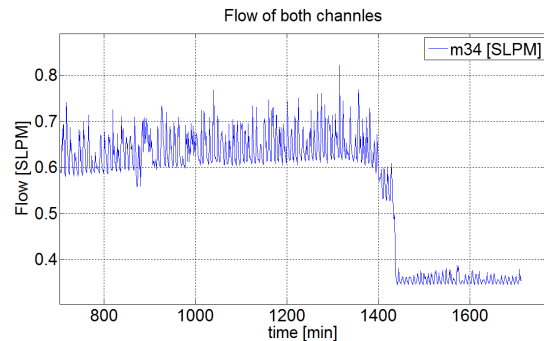

$$\dot{m}_{std} (1100[\text{sec}] < t < 1400[\text{sec}]) = 0.21[\text{SLPM}]$$

$$\dot{m}_{std} (1450[\text{sec}] < t < 1700[\text{sec}]) = 0.04[\text{SLPM}]$$

Figure 7-Pulsating Flow in channel 3-4

**4.2 Full experimental operation**

In the following experiment the two channels (hot/cold) were activated. It can be seen in the temperatures difference graphs at fig.10, that the experiment reached a thermal steady state after about 30 minutes, while the

hydrodynamic response of the system is considerably faster. The temperatures were stabilized on next values:  
 $T1=1.2\text{ }^{\circ}\text{C}$ ,  $T2=-5.8\text{ }^{\circ}\text{C}$ ,  $T3=-28\text{ }^{\circ}\text{C}$ ,  
 $T4=-10.3\text{ }^{\circ}\text{C}$ .

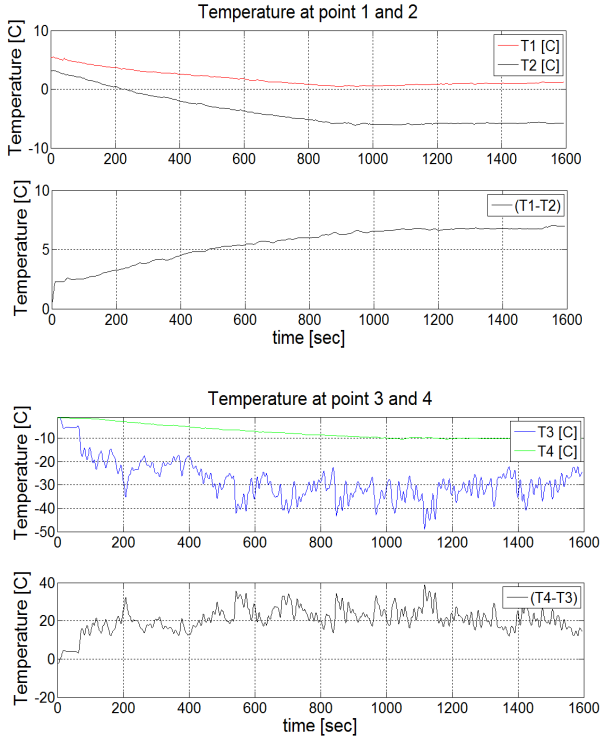

Figure 8-Temperature temporal evolution of both channels

*Temperature evolution;*

At port 3, Resistance Thermometer (RTD) that in use is 100 Ohm resistor which is one of the reasons that make the sample so noisy, other possible reason is flow instabilities inside the LN<sub>2</sub> supply system caused by two-phase flow inside the system.

Also it can be seen that temperature difference at channel 3-4 is considerably higher than at channel 1-2, fig.10 temperature difference graphs.

*Pressure evolution;*

During the experiment the pressure in channel 1-2 was changed, as presented in fig.11. The pressure at port 3 is reduced as the Dewar is emptied while the pressure at port 4 is stable. One should notice that the change in the

pressure at channel 1-2 doesn't influence the temperatures that are measured in the system.

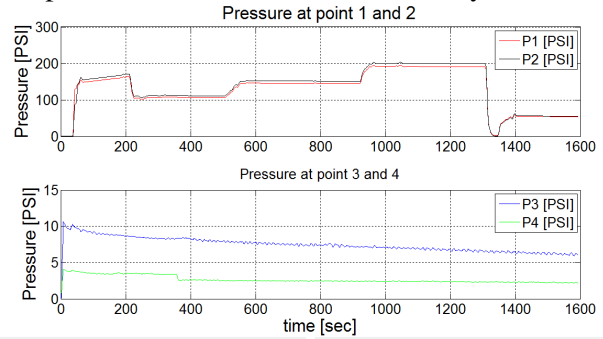

Figure 9-Pressure profile

*Flow evolution:*

Flow levels were kept the same at both channels which mimics the necessary conditions of a JT micro-cooler. It was a tricky task because the resolution of the needle valves is insufficient for such a combination of small flow rates and high pressure levels.

The spikes presented in the graph are flow adjustments consequent to pressure changes in channel 1-2.

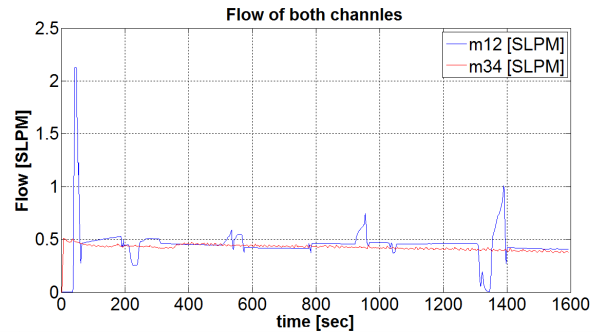

Figure 10-flow rate during the test

**5. Conclusions and future work**

The current study presents the construction of an experimental apparatus for studying RCFHE made by standard microfabrication techniques. Several practical issues, like avoiding direct metal-glass contact and minimizing bending forces are discussed. Two preliminary runs are presented; in the first LN<sub>2</sub> is introduced into a single port of the RCFHE and in the second run both ports were active and a thermal steady state was obtained. The next step would be to perform an in-depth thermal analysis of the system during which

the characteristics of the RCFHE will be isolated and characterized. Additional RCFHE designs are planned to be examined with this setup.

## **6. References**

- [1] P.P.P.M. Lerou, S.Vanapalli, H.V.Jansen et al., Microcooling Development at the university of Twente, Advances in Cryogenic Engineering: Transactions of the Cryogenic Engineering Conference-CEC 51,edited by J.G Weisend II (2006).
- [2] H.S. Cao a, A.V. Mudaliar a, J.H. Derking a, P.P.P.M. Lerou b, H.J. Holland a, D.R. Zalewski a, S. Vanapalli a,H.J.M. ter Brake a, Design and optimization of a two-stage 28 K Joule–Thomson microcooler, Cryogenics 52, 51–57 (2012).
- [3] Andrew A. Gage and John G. Baust cryosurgery - a review of recent advantages and current issues, CryoLetters 23, 69-78 (2002).
- [4] Weibin Zhu, Michael J. White, et al, two approaches to micromachining si heat exchanger for Joule-Thomson cryosurgical probes, MEMS 2007, Kobe, Japan, 21-25 January (2007).
- [5] Pan Mao and Jongyoon Han, Fabrication and characterization of 20 nm planar nanofluidic channels by glass–glass and glass–silicon bonding, Lab Chip, 5, 837–844 | 837 (2005).
- [6] Che-Hsin Lin, Gwo-Bin Lee, et al, A fast prototyping process for fabrication of microfluidic systems on soda-lime glass, J. Micromech. Microeng. 11, 726–732 (2001).
- [7] David R. Emerson, Krzysztof Cieslicki et al, Biomimetic design of microfluidic manifolds based on a generalised Murray's law, Lab Chip, 6, 447-454 (2006).
- [8] Robert W.Barber and David R. Emerson, Optimal design of microfluidic networks using biologically inspired principles, Microfluid Nanofluid, 4, 179-191 (2008).