



GLOBAL JOURNAL OF RESEARCHES IN ENGINEERING
ELECTRICAL AND ELECTRONICS ENGINEERING
Volume 13 Issue 2 Version 1.0 Year 2013
Type: Double Blind Peer Reviewed International Research Journal
Publisher: Global Journals Inc. (USA)
Online ISSN: 2249-4596 & Print ISSN: 0975-5861

Tunable Multiband Micro Strip Antenna for 5ghz Wlan

By Ali Ejaz, R. Nilavalan & Hattan Abutarboush

Brunel University

Abstract - In this paper, a tunable Multiband Micro strip Antenna is designed, capable of tuning its operating frequency in 5GHz band independently. Two slots of E & U shape are etched to achieve multiband resonance. Two capacitors of fixed value and a varactor diode are used to achieve tuning. Proposed antenna targets the 5GHz WLAN bands; UNII-1 and UNII-2. Simulated and measured results are in good agreement.

Indexterms : reconfigurable antenna, fr reconfigurability, variable reactive loading, 5ghz Wlan.

GJRE-F Classification : FOR Code: 100501



Strictly as per the compliance and regulations of :



© 2013. Ali Ejaz, R. Nilavalan & Hattan Abutarboush. This is a research/review paper, distributed under the terms of the Creative Commons Attribution-Noncommercial 3.0 Unported License (<http://creativecommons.org/licenses/by-nc/3.0/>), permitting all non commercial use, distribution, and reproduction in any medium, provided the original work is properly cited.

Tunable Multiband Micro Strip Antenna for 5ghz Wlan

Ali Ejaz^α, R. Nilavalan^ο & Hattan Abutarboush^ρ

Abstract - In this paper, a tunable Multiband Micro strip Antenna is designed, capable of tuning its operating frequency in 5GHz band independently. Two slots of E & U shape are etched to achieve multiband resonance. Two capacitors of fixed value and a varactor diode are used to achieve tuning. Proposed antenna targets the 5GHz WLAN bands; UNII-1 and UNII-2. Simulated and measured results are in good agreement.

Indexterms : reconfigurable antenna, fr reconfigurability, variable reactive loading, 5ghz Wlan.

I. INTRODUCTION

WORLDLY spectrum regulatory bodies have developed standards for the use of frequency spectrum and most applications are allocated fixed licensed frequency bands to operate; one has to pay in order to use licensed bands. On the contrary certain free of cost unlicensed frequency bands are also available for use such as ISM (Industrial, Scientific and Medical) Band is reserved internationally for the use of radio frequencies for industrial, scientific and medical purposes. At present 2.4 GHz ISM band is the most adopted unlicensed band available in the world; in most countries it ranges from 2.4 to 2.483 GHz. Wireless LAN IEEE 802.11b/g/n is a common application that uses 2.4 GHz ISM band. Beside WLAN, Bluetooth technology, IEEE 802.15.4/Zigbee, cordless phones, microwave ovens, other industrial & home used appliance operates in 2.4 GHz ISM band. Being widely used by many technologies; 2.4 GHz band has become increasingly crowded and interference has become inevitable. Interference problem can be reduced by effective frequency planning or via using an alternative unlicensed frequency band [3-6].

Recently USA & Canada have developed 5 GHz WLAN standards; the band is divided into several sub-bands named as Unlicensed National Information Infrastructure (UNII) bands. The UNII-1 band is designated for indoor operations, the UNII-2 and UNII-2 extended bands are for indoor and outdoor operations, and the UNII-3/ISM band is intended for outdoor bridge products and may be used for indoor WLANs as well. Table-1 shows the frequency range and number of channels for each 5 GHz UNII bands [4].

Author α σ ρ : School of Engineering & Design, Brunel University, Uxbridge, Middlesex, UB8 3PH, UK.
E-mails : mmaliejaz@hotmail.com, Rajagopal.Nilavalan@brunel.ac.uk, Hattan.Abutarboush@kaust.edu.sa

5GHz UNII Bands	Frequency range (GHz)	No. of Channels
UNII-1	5.17 – 5.24	4
UNII-2	5.25 – 5.35	4
UNII-2e	5.47 – 5.70	11
UNII-3	5.74 – 5.82	8

Table 1 : 5 GHz WLAN Bands

A reconfigurable antenna is the one that has selectable or tunable fundamental characteristics that includes operating frequency, radiation pattern, and polarization. In general, the objective is to alter one or more of these characteristics independently of the others. Methods being used to vary the parameters are electrical, mechanical, or electromechanical in nature. Depending upon the primary antenna parameters, reconfiguration mechanism can be classified into three major categories which are; frequency response reconfigurability, radiation pattern reconfigurability and polarization reconfigurability. In frequency response (FR) reconfigurability, antenna varies its resonant frequencies; this variation can be continuous or discreet depending upon the technique employed. There are several possible means to achieve FR reconfigurability such as switches, variable reactive loading, mechanical changes or material changes. The electric methods involves the use of switches such as Pin diode, MEMS, FET switches; cause discrete change in resonant frequency; and variable reactive loading technique that make use of varactor diode that yields continuous tuning of resonant frequency [1].

In this paper, FR reconfigurability is exercised using variable reactive loading technique. Hence, a tunable micro strip antenna has been designed which can operate in multiple frequency bands and capable of altering one of its resonant frequencies independently. Proposed antenna has the advantage of being light weight, slim, small in size, cost effective, easy to fabricate and simple structure targeting small portable device to be used in years to come.

The objective is to achieve FR reconfigurability and implication in achieving it lies in the fact that resonant frequencies are closely related to each

other[1]. This means, in case of multiband frequency response; efforts make to change one frequency might vary other frequencies too. Therefore question arises, how is it possible to isolate resonant frequencies from each other to achieve independent tuning?

Effective electrical length (l_{ee}) of an antenna determines its resonant frequencies [2]. Therefore, key lies in identifying the part of slotted patch, responsible for a particular resonant frequency and then varying the effective electric length accordingly. This is done via performing parametric study and investigating surface current distribution (SCD) of antenna for all resonant frequency bands. Tuning is obtained by adding variable capacitance to the design. Varactor diode behaves like a variable capacitor if its reverse biased voltage varies. This property of varactor diode is exploited here and its introduction to design causes effective electrical length of the antenna to vary, and in turn results in tuning of resonant frequency of antenna.

II. DESIGN PROCEDURE

Initially, multiband micro strip antenna of rectangular patch is designed on a substrate material FR-4 of size $(35 \times 35 \times 1.57)$ mm³ with dielectric constant $\epsilon_r = 4.4$, micro strip feed line method is used to feed the antenna and E & U shape slots are etched in the patch to achieve multiband frequency response. Fig. 1 shows the geometry of purposed antenna. And Fig. 2 shows the simulated S11 of the proposed antenna where multiple bands were achieved at 3, 4 and 5 GHz. In order to investigate the independency of three frequency bands, variations in some effective parameters such L_p , W_p and size of E & U-slot were done. The results yielded from parametric study are as follows:

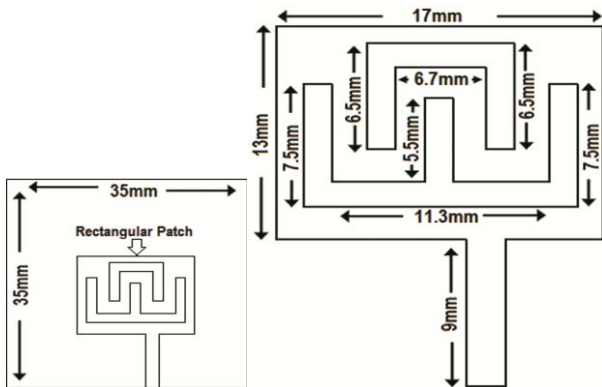

Fig. 1(a) : Antenna Geometry Fig.1(b) : Rectangular Patch Geometry

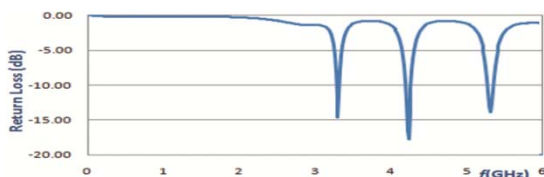

Fig. 2 : Simulation results: S₁₁ parameter

1. Change in W_p caused variation in resonant frequency of 3GHz band only.
2. Altering L_p resulted in change of resonant frequency in 4GHz band only.
3. Variation in E-Slot affects the 5GHz band and independent tuning is observed as depicts in fig 3.

The application, I have intended to target here is 802.11 5GHz WLAN; therefore this paper only takes account of 5GHz band. Consequently simulation results of parametric study related to 5GHz band are provided. After observing that variation in E-slot varies the resonant frequency in 5GHz band, next step is to investigate SCD for all bands in order to locate a position on patch where integration of varactor diode could yield independent tuning. Fig.4 shows that current distribution for 5GHz band is along E-slot.

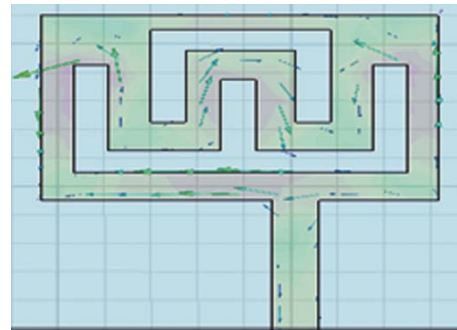

Fig. 4 : S₁₁ Vector SCD

Therefore upon examining SCD for other bands and using trial & error method, optimum positions for varactor diodes and capacitors are identified, see fig.5. Varactor diode (D_1) with the capacitance range from 8.5pF to 0.6pF and reverse biased voltage range from 30V to 0V is employed. When reverse biased voltage varies, capacitance of diode changes in result; that in turn alters effective electrical length of the antenna for resonant frequency in 5GHz band. Hence independent tuning of resonant frequency is achieved successfully. A capacitor (C_1) of size 0.5×0.5 mm² with fixed

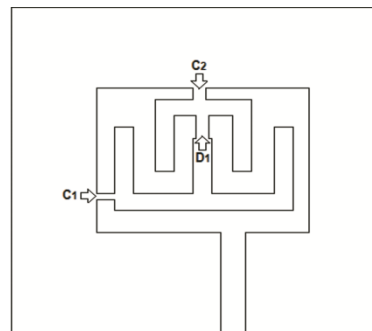

Fig. 5 : Tunable Multiband Antenna Design

Capacitance of 10pF and capacitor (C_2) of fixed value of 1pF is used for the purpose of AC coupling, as it blocked the DC to flow from one part of the patch to

other and allow only AC to pass through. Fig.6 depicts the simulation results for S11 parameters.

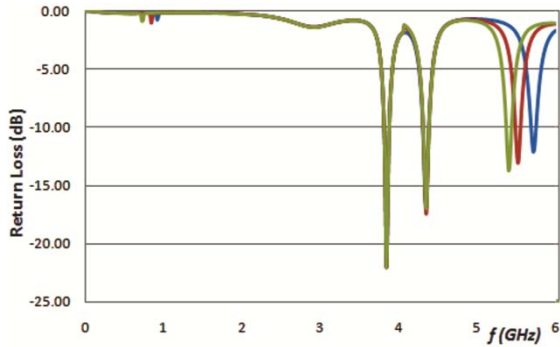
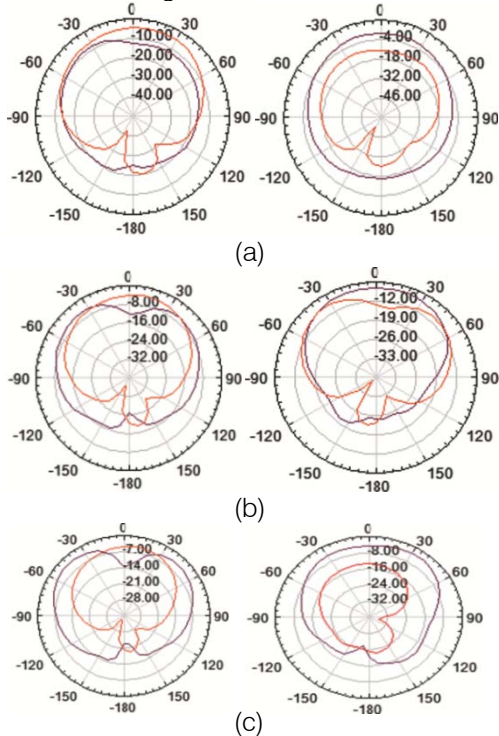

Fig. 6 : Simulation Results: independent tuning of 5GHz band

Green lines show the resonance frequencies when reversed biased voltage is low (0V) i.e. capacitance of varactor diode is low. As the reversed biased voltage increased, resonance frequencies in 3GHz & 4GHz bands remained unchanged while the change in 5GHz band is observed (red & blue lines); hence tuning required band is achieved, ranges from 5.09 to 5.46 GHz.

Furthermore, radiation pattern of the antenna is depicted in fig. 7, at each point of the radiation sphere the polarisation is generally resolved into two components know as cross-polarisation and co-polarisation. Co-polarisation is antenna intended to radiate or receive where as cross-polarisation represents the polarisation perpendicular to co-polarisation. Antenna exhibits good radiation characteristics, see fig 7.



III. IMPLEMENTATION PROCEDURE

a) Implementation

After completing design and obtaining optimum simulation results on HFSS, hardware implementation is accomplished using Lab facilities at Brunel University, UK. Fig. 8 shows the actually implemented antenna.

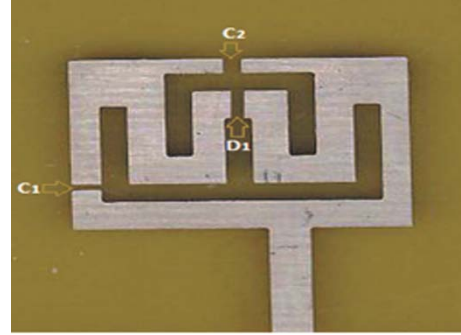

Fig. 8 : Actual implemented Antenna

b) Validation

When antenna is fabricated, varactor diode and capacitors are integrated on the patch at identified positions. Then S_{11} parameter is measured using network analyzer in the antenna lab of Brunel University and compared with the one obtained in simulation on HFSS. Fig. 9 shows S_{11} parameter results obtained from network analyzer.

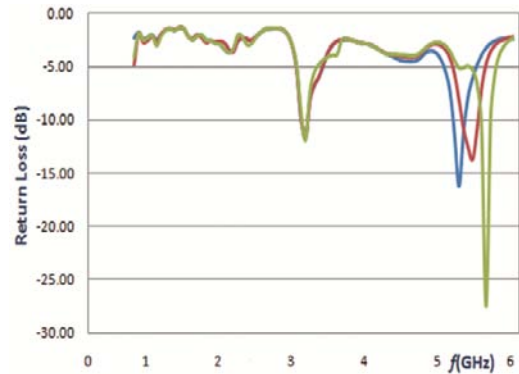

Fig. 9 : Measured Results: independent tuning of 5GHz band

Blue line shows resonance frequencies when reverse biased voltage is low (1V); i.e. depletion region narrows and capacitance offered by varactor is high. As reversed biased voltage increases, depletion region widens thereby capacitance decreases; consequently resonance frequency of 5GHz band has increased (red & green lines). On the contrary resonance frequency of 3GHz & 4GHz bands remain unchanged, see fig 9. Thus independent tuning of 5GHz band has achieved; ranges from 5.09 to 5.46 GHz.

c) Simulation Vs Measured Results

Upon comparing results depicted in fig.6 and fig.9, it can be observed that antenna has multiband

resonance and independent tuning of 5GHz band is achieved practically. Only difference among the results is; implemented antenna is not resonating in 4GHz band effectively. The possible reasons behind this are as follows [7]:

i. *Substrate Material*

In micro strip antennas dielectric constant ϵ_r and substrate thickness h have great impact on antenna parameters and deviations from the specified values alter the resonating frequencies.

ii. *Antenna Production Problems*

While antenna fabrication etching errors and stress relief after etching affects physical dimensions of antenna. Hence deviations from ideal results may occur in frequency response.

iii. *Components Effect*

Exposure of varactor diode to extensive heat while soldering on antenna patch may affect its working that may cause deviation from desired results.

iv. *Connecting Wires Effect*

Conductors exhibits capacitive or inductive behaviour at high frequencies. Thus connecting wires, supplying dc reverse bias voltage to diodes may also have impact on resonant frequency of antenna.

IV. PROPOSED APPLICATION

Implemented antenna is capable of tuning its operating frequency in 5GHz band; ranges from 5.09 to 5.46 GHz. That covers the frequency range of UNII-1band (5.17 to 5.24 GHz) and UNII-2 band (5.25 to 5.35 GHz) with ease.

V. CONCLUSION

Effort has been made to design and implement a reconfigurable multiband micro strip antenna. There are several kinds of reconfigurability and various possible means to achieve them. But in this work frequency response reconfigurability is exercised using reactive loading method. A rectangular patch antenna is designed using substrate material FR-4 of size $(35 \times 35 \times 1.57)$ mm³ with $\epsilon_r = 4.4$ and E & U-slots are etched to achieve multiband resonance. Then varactor diode, having capacitance range 0.6pF to 8.5pF and reverse biased voltage range 30V to 0V, integrated on the patch. Change in reverse biased voltage causes capacitance of the diode to vary that in turn alters the effective electrical length (l_{ee}) of the antenna. As resonant frequency of the antenna is associated with its (l_{ee}), therefore continuous change in it results in tuning of resonant frequency.

REFERENCES RÉFÉRENCES REFERENCIAS

1. J. T. Bernhard, *Reconfigurable Antennas*: Morgan & Claypool, 2007.
2. C. A. Balanis, *ANTENNA THEORY ANALYSIS AND DESIGN*, Third ed.: John Wiley & Son, INC., 2005.
3. H. Ming-Ju, *et al.*, "RF challenges for 2.4 and 5 GHz WLAN deployment and design," in *Wireless Communications and Networking Conference, 2002. WCNC2002. 2002 IEEE*, 2002, pp. 783-788 vol.2.
4. Dynamic Frequency Slection for 5 GHz WLAN in the USA and Canada, FCC regulations update, 2007.
5. A. Kamerman and G. Aben, "Throughput performance of wireless LANs operating at 2.4 and 5 GHz," in *Personal, Indoor and Mobile Radio Communications, 2000. PIMRC 2000. The 11th IEEE International Symposium on*, 2000, pp. 190-195 vol.1.
6. Behzad, Arya, "Wireless – LAN radio design and IEEE standards bundle" in *Communication, networking and broadcasting conference, EW1273, 2012*.
7. P. S. H. a. C. W. J.R.James, *Microstrip Antenna Theory and Design* vol. 12. London and New York: IEE, 1981.