

Marco Ajovalasit*

Arber Shabani

Joseph Giacomini

Human Centred Design Institute (HCDI)

Perception Enhancement Systems (PES) research group

Brunel University, School of Engineering and Design

Uxbridge, Middlesex, UB8 3PH, United Kingdom

E-mail: marco.ajovalasit@brunel.ac.uk*

E-mail: arber.shabani@brunel.ac.uk

E-mail: joseph.giacomini@brunel.ac.uk

*corresponding author

Ana Tajadura-Jiménez

Laboratory of Action and Body (Lab)

Psychology Department

Royal Holloway, University of London

Egham, Surrey, TW20 0EX, UK

email: ana.tajadura@rhul.ac.uk

Abstract

This study investigates what form of correlation may exist between measures of the valence and the arousal dimensions of the human emotional response to steering wheel vibration and the vibration intensity metrics obtained by means of the unweighted and the frequency weighted root mean square (r.m.s.). A laboratory experiment was performed with 30 participants who were presented seventeen acceleration time histories in random order and asked to rate their emotional feelings of valence and arousal using a self-assessment manikin (SAM) scale. The results suggest a highly linear correlation between the unweighted, Wh weighted and Ws weighted vibration intensity metrics and the arousal measures of the human emotional response. The results also suggest that while vibration intensity plays a significant role in eliciting emotional feelings, there are other factors which influence the human emotional response to steering wheel vibration such as the presence of high peaks or high frequency band amplitudes.

Keywords: driver experience, emotion; perception; human; frequency weightings, hand-arm, vibration; automobile; steering; road.

1. Introduction

The perceptual experiences which occur at a product or service interface are fundamental towards cognitive and emotional engagement. The perceived quality of a brand and usability of a product, the comfort when using it, as well as its effectiveness, can all depend on the nature and intensity of the emotional experience. Emotional or affective reactions to the different sensory stimuli are an often neglected component of interior automobile design development, although being crucial, since emotional events have the capability to interrupt ongoing cognitive processes and automatically grab attention, eliciting an attentional or behavioural switch towards these events (Öhman 1993, Phelps et al., 2006). For safety, situation awareness and brand perception, it is becoming very important for automotive designers to consider the emotional state of the driver in response to the various events taking place during the driving experience. Stimuli from all sensory modalities can carry emotional information, from visual (Lang et al., 1993), to auditory (Bradley and Lang, 2000) and even simple vibrotactile stimulation (Salminen et al., 2008), although little systematic research has focused on how stimuli other than visual elicit emotions. Hence, in order to improve road safety and driver emotional engagement, it is important for car designers to consider the emotional response of the driver to the various events taking place during the driving experience, and to find the most efficient way to minimize signals that can distract and annoy the driver, while maximizing signals that are useful in assisting the driver. These signals must capture attention and obtain fast and intuitive responses from the driver in critical situations, while maintaining an appropriate level of information load which makes the driving experience pleasant and relaxing in non-critical situations.

Car interior designers have traditionally considered drivers' emotional response mainly in terms of annoyance or discomfort elicited by the mechanical stimuli such as the sound and vibration produced by the car (Ajovalasit and Giacomini, 2007). While most of the research performed to date has mainly addressed the needs of reducing the intensity of the mechanical stimuli with the preconception that "less is better", recent research in the field of user interfaces (van Erp and van Veen 2004, Ho et al., 2007, Spence and Ho 2008) has turned its attention to the study of multisensory emotional interfaces in which stimuli, mainly artificial, can be used to enhance efficiency in capturing attention and in producing fast and/or accurate responses from users so as to provide feedback about an action, alerts or warnings. However, mechanical signals can also provide important contextual information to the driver such as about a car or road condition (Giacomini and Woo, 2004, Berber et al., 2010) or in occasions capture and direct users' attention towards important events such as a failure in the engine. Mechanical signals can also contribute to the overall pleasantness of driving a car, since the sound and vibrations produced by the car are often associated to powerfulness, sportiness, luxury, reliability and comfort (Penne, 2004). The sound emitted by the car door being closed, or the sound and vibrations emitted by the car engine may become an acoustic/ vibrotactile "footprint" of a specific brand that makes the product more attractive to the user, and thus can improve the driver's overall pleasantness and

satisfaction (Lyon 2000, Västfjäll 2003). While a significant body of literature has analysed product sound quality (Blauert and Jekosch, 1997, Lee 2006) looking at the adequacy of sound stimuli in the context of a specific technical goal or task, little research has been performed to understand the human emotional response to interior car mechanical vibrations alone, which a driver feels through the seat, floor or steering wheel.

Of the car/driver interfaces, the steering wheel (Pak et al., 1991) is a fundamental subsystem due to the sensitivity of the skin tactile receptors of the hand (Bolanowski Jr and Gescheider, 1988) and due to the lack of intermediate structures such as shoes and clothing which can act to attenuate vibration stimuli. Recent research (Berber et al., 2010) has found that an amplification of selected time domain features or selected frequency bands of the steering wheel vibration signal facilitates road surface type detection. During driving, steering wheel power spectral densities can reach frequencies of up to 350 Hz with vibrational energy mostly present in the range between 10 and 60 Hz (Fujikawa, 1998, Berber et al., 2010). They are typically characterised by low frequency excitation in the range from 8 to 20 Hz due to 1st order tyre non-uniformity forces and tyre-wheel unbalance, and due to 2nd order engine and mechanical unbalance in the frequency range from 20 to 200 Hz (Ajovalasit and Giacomini, 2003).

Previous research regarding the human subjective response to hand-arm vibration have contributed to the definition of vibration intensity metrics by means of the Wh frequency weighting which is currently used in both International Organisation for Standardization 5349-1 (2001) and British Standards Institution 6842 (1987). The Wh frequency weighting is primarily intended for use in measuring and reporting hand-arm exposures for the purpose of quantifying possible health effects, but as the only standardised frequency weighting available it has often been used in the automotive industry for evaluating the perceived intensity of steering wheel vibration. With respect to automotive steering vibration, research has led to a preliminary proposal (Giacomini et al., 2004) for a steering wheel frequency weighting, Ws, and to a partial confirmation of its accuracy (Amman et al., 2005). A study by Gnanasekaran et al. (2006) has evaluated the correlation between the weighted vibration intensity metrics obtainable when applying the Wh or Ws weightings and the measures of subjective perceived intensity response provided by test participants for eight different types of steering vibration stimuli. The data suggested that the Ws weighting provided a slightly better correlation than the Wh weighting. While the psychophysics of the human subjective response to hand-arm vibration is relatively well understood in terms of properties such as the amplitude response, the frequency response, and masking effects, less is known about the factors influencing the human emotional response to the vibration which a driver feels through the steering wheel.

The present study investigates the research hypothesis that a systematic correlation may exist between measures of the valence and the arousal dimensions of the human emotional response to steering wheel vibration provided by test participants and the vibration intensity metrics which can be achieved from the steering wheel acceleration signals themselves by means of the unweighted r.m.s., Wh and

Ws frequency weighted r.m.s. values. The current study also investigates what analytical form this relationship may assume.

2. Experiment

2.1 Test Stimuli

The test stimuli used were seventeen steering wheel acceleration time histories which were selected from an extensive database of road test measurements previously performed by the research group (Gnanasekaran, 2006, Berber et al., 2010). The steering wheel vibration stimuli were chosen based on the fact the steering vibration should be mainly caused by the act of driving over a road surface. This was decided based on the results of a previous questionnaire study (Gnanasekaran, 2006) which suggested that the respondents considered steering wheel vibration to be particularly useful towards the detection task of determining the road surface type. For each road a two-minute recording of the steering wheel acceleration had been measured by means of an accelerometer which was rigidly clamped to the surface of the steering wheel at the 60° position (two o'clock position) with respect to top centre, which is the most common grip position adopted by nonprofessional driver's (Gnanasekaran, 2006). The accelerometer had been mounted so as to measure the acceleration in the direction which was tangential to the steering wheel rotation. For all roads and automobiles the accelerometer type and the mounting clamp used were appropriate for the frequency range from 0 to 300 Hz.

The seventeen steering wheel time histories were all from mid-sized European automobiles which were driven in a straight line over the test road at a speed which was consistent with the surface type (Department of Transport, 2006). Driving conditions were selected such that they were characterised by significantly different statistical signal properties and that the widest possible operating envelope could be achieved in terms of the steering acceleration root mean square value (r.m.s.), kurtosis value, crest factor value and power spectral density function. Figure 1 presents the seventeen road surfaces which had produced the steering wheel acceleration time histories, as viewed from directly above and as seen when driving. The names assigned to the individual road surfaces for organisational purposes were: 1cm metal bar, broken road, broken concrete, broken lane, bump, cats eyes, cobblestone, concrete road, country lane, expansion joints, low bump, manhole, rumble strips, slabs, stone on road, tarmac and transverse. Of these, ten, namely 1cm metal bar, bump, cats eyes, expansion joints, low bump, manhole, rumble strips, slabs, stone on road and transverse joints can be classified as containing significant transient events, while the remaining seven, namely broken road, broken concrete, broken lane, cobblestone, concrete road, country lane and tarmac can be broadly classified as mildly non-stationary signals (Giacomin et al., 2000).

[Insert Figure 1]

A short but statistically representative (Giacomin et al., 2000) segment of data was extracted from each of the seventeen acceleration time histories. The segments were selected such that the root mean square values, the kurtosis, crest factor value and the power spectral density were close to those of the complete time history. For all driving conditions, a 7-second segment was taken so as to remain within human short term memory (Baddeley, 1997). Since none of the steering wheel acceleration time histories contained significant vibrational energy at frequencies greater than 120 Hz, the decision was taken to apply a bandpass digital Butterworth filter to limit the vibrational energy to the frequency range from 3 Hz to 120 Hz, the lower cut-off value of 3 Hz having been chosen in recognition of the frequency response limitations of the electrodynamic shaker unit of the laboratory test bench. Figure 2 presents the resulting time history segments while Figure 3 presents the respective power spectral densities. From Figure 3 it can be seen that the steering wheel power spectral densities determined from all the roads and test conditions showed that a significant amount of vibrational energy was present in the frequency range between 10 and 60 Hz, but that vibrational energy was much lower outside this range. The global statistical properties calculated for the complete original recording over each road surface is presented in Table 1.

[Insert Figure 2]

[Insert Figure 3]

[Insert Table 1]

2.2 Test Facility

Figure 4 presents a schematic representation of the steering wheel rotational vibration test rig used to perform the laboratory experiments, along with the associated signal conditioning and the data acquisition system used. Table 2 presents the main geometric dimensions of the test rig, which are based on data from a small European automobile. The test rig seat was fully adjustable in terms of horizontal position and back-rest inclination as in the original automobile.

[Insert Figure 4]

[Insert Table 2]

The rotational steering system consisted of a rigid 325 mm diameter aluminum wheel connected to a steel shaft which was mounted onto two precision bearings which were encased in a square steel casing. The shaft was connected to an electrodynamic shaker by means of a steel stinger rod. The steering wheel consisted of a 5 mm thick central plate with 3 mm thick cylinders welded at the extremities. The steering wheel was made of aluminum in order to obtain a first natural frequency greater than 350 Hz. The use of a rigid steering wheel guaranteed that no vibration attenuation occurred before reaching the hand-arm system. Rotational vibration was applied by means of a G&W V20 electro dynamic shaker driven by PA100 amplifier. The steering wheel acceleration was measured

by means of an Entran EGAS-FS-25 accelerometer attached to the top left side of the wheel and the acceleration signal was amplified by means of an Entran MSC6 signal conditioning unit. Control and data acquisition were performed by means of the Leuven Measurement Systems (LMS) Cada-X 3.5 F software system coupled to a DIFA SCADASIII unit (LMS International, 2002).

The maximum stroke of the test rig shaker unit (± 10 mm) limited the maximum achievable acceleration at the steering wheel which, in turn, limited the minimum test frequency to 3 Hz. For frequencies lower than approximately 3 Hz accurate acceleration signals could not be achieved at the rigid steering wheel. The safety features of the rig and the acceleration levels used conform to the health and safety recommendations outlined by British Standards Institution BS 7085 (1989).

In order to determine the stimuli reproduction accuracy of the test rig facility an evaluation was performed. The procedure evaluated the complete chain composed of the LMS software, the front end electronics unit, the electro-dynamic shaker, the accelerometer and the signal conditioning unit. The accuracy of the target stimuli reproduction was quantified by measuring the r.m.s. difference between the actuated signal and the target signal. Eight participants were used in the pre-test process so as to consider also the possible differences in bench response which are caused by differences in impedance loading on the steering wheel from people of different size. Results suggested that the maximum percent of error between the r.m.s. acceleration level of the target signal and the actuated signal was found to be less than 5% for all stimuli used in the pre-test.

2.3 Test Subjects

A total of 30 university students and staff participated in the experiment. A consent form and a short questionnaire were presented to each participant prior to testing and information was gathered regarding their anthropometry and health. Gender, age, height, weight and driving experience data were collected, and the participant was requested to state whether he or she had any physical or mental condition that might affect the perception or the emotional response to hand-arm vibration, and whether he or she had smoked or ingested coffee within the 2 hours previous to arriving in the laboratory. Table 3 presents a basic summary of the physical characteristics of the group of test participants. The group consisted of 25 males and 5 females. The mean values and the standard deviation of the height and weight of the test participants presented in Table 3 were near the 50 percentile values for the U.K. population (Pheasant and Haslegrave, 2005) except in the case of age, which was somewhat lower than the UK national statistics. Driving experience ranged from 3 years to 25 years with a mean value of 5.6 years. No test participant declared a physical or a cognitive condition which might affect the perception of hand-arm vibration. All subjects declared themselves to be in good physical and mental health and none declared having smoked or ingested coffee prior to arriving in the laboratory. All had more than two years of driving experience.

[Insert Table 3]

2.4 Test Protocol

For purposes of simplicity, standardisation and facilitation of comparison with results from other fields (Greenwald et al., 1989), the emotional response of the test participants was measured by means of the well known Self-Assessment Manikin (SAM). In its most basic form (Cohan and Allen 2007) the SAM consists of a set of symbolic graphical representations of the human body under various degrees of emotional response (see Figure 5). The graphical correlates of the emotional response are visually associated with a Likert format rating scale, which is used by the test participant to choose a numerical value to indicate his or her emotional valence (pleasure) and level of arousal (excitement). The Likert format rating scale provides values from 1 to 9 to span the range from unpleasant to pleasant in the case of the valence, and to span the range from calm to excited in the case of the arousal dimension. In the basic form adopted for use in the current study the SAM provides a two dimensional measure of the human emotional state based on the direction and size of the response. The use of the SAM scale has been found to be reliable and to be comparable to the human emotional responses derived from the relatively longer semantic differential scale (Bradley and Lang, 1994). The advantage of the SAM measure is that it can be understood by different ethnic populations in different cultures and it is easy to administer in a laboratory-based experiments.

Before commencing testing each subject was required to remove any heavy clothes such as coats and to remove any watches or jewellery. They were then asked to adjust the seat position and backrest angle so as to simulate a driving posture as realistically as possible. Since grip type and grip strength (Reynolds and Keith, 1977) are known to effect the transmission of vibration to the hand-arm system, the subjects were asked to maintain a constant palm grip on the steering wheel using both hands. The subjects were also asked to wear ear protectors so as to avoid auditory cues. Room temperature was maintained within the range from 20°C to 25°C so as to avoid significant environmental effects on the skin sensitivity (ISO 13091-1, 2001).

A PC-based software programme running on a HP Pavilion HDX 9000 laptop computer was developed for the purpose of measuring the human emotional response to vibration stimuli. For each test vibration stimulus the dedicated software programme first presented an image of the test road condition for a fixed period of time, then presented the SAM emotional response self-rating scale. The HP Pavilion HDX 9000 laptop had a 20.1 inch wide screen which was set at an inclination of 15° with respect to the vertical. The laptop was positioned on a stand at about 1m ahead such that the centre of the screen was at approximately the eye height of the test participant. Each of the seventeen stimuli was presented three times to each of the 30 participants for a total of 90 estimates for each test road condition. During each test a series of 7-second steering wheel acceleration stimuli were presented to

the participant, using a 10 second gap between each stimulus during which each participant was asked to rate their emotional state of the perceived vibration felt through the steering wheel using the SAM scale. Providing participants 10 seconds in which to consider the stimulus, self-reflect on the emotional state produced, and select the two SAM emotional responses (valence and arousal) was found to be appropriate following a pilot test with three individuals. In addition, a total elapsed time of 17 seconds per stimuli also appeared appropriate due to permitting the participant to perform all relevant operations within the confines of human short term memory (Baddeley 1997). In order to minimize any possible bias resulting from learning or fatigue effects, the order of presentation of the test signals was randomized for each participant. Three preliminary tests, whose data were not analysed, were performed so as to familiarise the participant with the procedure. The automobile speed associated with each stimulus was not provided, and no feedback was provided about the possible correctness of judgement. A complete experiment lasted approximately 35 minutes min for each test participant. The facility and protocol were reviewed and found to meet University guidelines for good research practice.

[Insert Figure 5]

3. Results

Table 4 presents the mean affective ratings and one standard deviation values obtained across the group of 30 participants for the valence and arousal responses to the steering wheel vibration stimuli for each of the seventeen road conditions analysed in this study. A one-factor ANOVA test (Hinton, 1999) performed across each emotional dimension suggested that all the values were statistically significant differences at $p=0.01$ confidence level. As can be seen from the table the standard deviation was found to generally increase with increasing test vibration intensity indicating a greater difficulty on the part of the participant to distinguish high vibration intensity stimuli. Another feature that can be observed is that the affective ratings obtained in this study accounted for almost half the dynamic range of the nine-point SAM scale values for both the valence and arousal dimensions. This result would suggest that the set of automotive steering wheel vibration acceleration levels associated to the driving conditions of this study did not elicit either highly unpleasant sensations or excited sensations. In order to investigate how changes in the vibration intensity levels may cause changes in the induced human emotional response to the steering wheel vibration stimuli, the mean affective ratings of valence and arousal were plotted against the unweighted r.m.s. acceleration amplitude of the seventeen test stimuli as shown in Figure 6. The distribution of the data points presented in Figure 6 suggests a relatively linear relationship between the unweighted vibration intensity and the induced human emotional response.

In order to determine if a systematic correlation existed between numerical measures of the valence and the arousal dimensions of the human emotional response to steering wheel vibration and the vibration intensity metrics, the affective ratings were plotted as a function of the most commonly vibration intensity metrics used to assess steering wheel vibration, namely the unweighted and frequency weighted r.m.s. vibration intensity metrics. Table 4 presents the unweighted, the Wh

weighted, the W_s weighted r.m.s. acceleration amplitudes as determined by means of two IIR digital filters (Williams. C.S. 1986) which were implemented in the LMS TMON software following software following the frequency specifications and tolerances outlined in ISO 5349-1 (2001) and in Giacomini et al. (2004).

[Insert Figure 6]

[Insert Table 4]

Psychophysical relationships were expressed by means of the Stevens' power law (Gescheider, 1997) between emotional response and stimulus intensity. When plotted on a log-log graph the power function has a convenient feature of becoming a linear function with the slope equal to the value of the power exponent. This has proved useful in evaluating the closeness of fit of the power law to the experimental data. Figure 7 presents the mean affective ratings of valence and arousal plotted as a function of the unweighted, the W_h weighted or the W_s weighted r.m.s. acceleration amplitude of the seventeen test stimuli. Also presented are the Stevens' power law exponent n , the coefficient of determination R^2 and the 95% confidence intervals which were determined from the data of each graph by means of least squares regression (Hinton, 1999). Figure 7a, 7c and 7e show that for the affective dimension of valence, the power law exponents were found to be less than unity and negative, suggesting that the emotional valence of steering wheel vibration is a decelerating function of the r.m.s acceleration amplitude. Whereas figures 7b, 7d and 7f show that for the affective dimension of arousal, the power law exponents were found to be less than unity and positive, suggesting that the emotional arousal of steering wheel vibration is a negatively accelerating function of the r.m.s acceleration amplitude.

[insert Figure 7]

For each of the two affective dimensions, the coefficient of determination (R^2) was also determined (Table 5) when correlating the measures of human emotional response to the analytical metrics of estimate of vibration intensity in terms of either unweighted or frequency weighted r.m.s. vibration levels. The coefficients of determination suggest that either form of frequency weighting (W_h or W_s) provides a more accurate estimate of human emotional response than does the unweighted acceleration, and that the W_s frequency weighting provides approximately better results. A possible explanation of the differences of the W_h and the W_s results may be the amount of vibrational energy found in each of the seventeen test stimuli at frequencies less than 8 Hz, where the W_s frequency weighting attenuates less. For example for the bump road and broken road conditions when the steering wheel vibration is expressed in terms of the W_s weighted r.m.s. acceleration (0.37 m/s^2 and 0.32 m/s^2 respectively) rather than the unweighted r.m.s. acceleration (0.88 m/s^2 and 1.22 m/s^2 respectively) or the W_h weighted r.m.s. acceleration (0.6 m/s^2 and 0.45 m/s^2 respectively), the difference between road surface conditions are greatly reduced and reversed in sign.

[Insert Table 5]

In order to investigate what form of relationship existed between the valence and the arousal dimensions of the human emotional response to steering wheel vibration, the experimental data were plotted in the two-dimensional affective space defined by the mean valence and arousal ratings of each road driving condition used in this study as shown in Figure 8. The distribution of the data points in Figure 8 suggests that high levels of emotional arousal (excited feelings) of steering wheel vibration are mostly associated with low levels of emotional valence (unpleasant feelings), and that high levels of emotional valence (pleasant feelings) are associated with low levels of emotional arousal (calm feelings) of the vibration. This result seems to be consistent with an underlying bimotivational structure of affective judgements which involve two systems of motivation, each varying towards either a high-arousal pleasant or a high-arousal unpleasant dimension (Greenwald et al., 1989). The relationship shown in the two-dimensional affective space for the different road driving conditions would also confirm the results of the current study whereby the differences in the human emotional response may be attributable to the differences in the r.m.s. acceleration values of the steering wheel vibration. In particular, low intensity steering wheel vibration stimuli with acceleration values less than 0.30 r.m.s. m/s^2 , such as those of the tarmac, concrete, slabs and low bump road conditions of the present study, elicited high levels of valence and low levels of arousal suggesting thus a more pleasant and calmer emotional response than higher intensity steering wheel acceleration stimuli. Whereas high intensity steering wheel vibration stimuli with acceleration values more than 1.70 r.m.s. m/s^2 , such as those of the broken concrete, broken lane and country lane driving conditions, were characterised by low levels of valence and high levels of arousal suggesting thus an unpleasant and aroused emotional response.

[insert Figure 8]

4. Discussion

Past research has shown that the perceptual experiences which occur at a steering wheel interface can depend on the nature and intensity of the emotional experience. A systematic study of the human emotional reaction to the vibrotactile stimuli perceived through an automotive steering wheel is highly important since emotional events have the capability to interrupt ongoing cognitive processes and automatically grab attention, eliciting an attentional or behavioural switch towards these events which can play a significant role in driver situation awareness.

The first research question addressed in this current study was which form, if any, of correlation existed between measures of the valence and the arousal dimensions of the human emotional response to steering wheel vibration provided by test participants and the vibration intensity metrics obtained by means of the unweighted and the frequency weighted r.m.s. values. The results of the current study suggest that the affective dimension of arousal is highly dependent on the vibration intensity. The higher coefficient of determination R^2 obtained for the measures of emotional arousal

(see Table 5) would suggest a tighter coupling between the emotional arousal measures and the vibration intensity metrics than the coupling between the emotional valence measures and the vibration intensity metrics of steering wheel stimuli. While difficult to either prove or disprove based only on the current data set, it is possible that the valence responses to steering wheel vibration may be influenced by cognitive constructs and stereotypes regarding the type of road presented.

Observations of the data in Figure 7 also suggest that that some of the road conditions were outliers of the 95 confidence intervals. These driving conditions, namely, 1cm metal bar, bump road, expansion joints, low bump and stone on road can all be broadly classified as transient events. A possible explanation of being outliers may be due to the fact that all these driving conditions are characterised by a time waveform having a high kurtosis value ranging from 8.05 to 17.12 as presented in the signal global statistics of Table 1. An estimate in terms of kurtosis is useful since being a 4th power metrics reflects an increased human sensitivity to high amplitude events present in the signal (Erdreich, 1986), and thus helps to quantify the extent of departure from stationary Gaussian distribution, for which the kurtosis value should be close to 3. The results of the current study would thus suggest that while vibration intensity plays a significant role in eliciting emotional feelings, it is also possible that there are factors other than vibration intensity which influence the human emotional response to steering wheel vibration, such as the presence of high peak events in the steering wheel stimuli. Also, Figure 8 shows that when steering wheel vibration stimuli are characterised by similar vibration intensity or similar frequency-band amplitude the levels of emotional response elicited are also similar. For example the rumble strips and 1cm metal bar driving conditions which are both characterised by an acceleration value of 1.24 r.m.s. m/s^2 and by a significant amount of vibrational energy mainly in the range between 25 and 60 Hz and much lower outside, elicited similar levels of emotional valence and arousal.

The second research question addressed in the current study was which form of relationship existed between the valence and the arousal dimensions of the human emotional response to steering wheel vibration. The results suggest that high levels of emotional arousal (excited feeling) of steering wheel vibration are mostly associated with low levels of emotional valence (unpleasant feelings), and that high levels of emotional valence (pleasant feelings) are associated with low levels of emotional arousal (calm feelings) of the vibration. Consistent with the underlying bimotivational structure of affective judgement, the results of the current study suggest that the affective space of valence and arousal of steering wheel vibration as shown in Figure 8 is characterised by high-arousal unpleasant feelings.

The results of the current study suggest that the extent of the variation in the human emotional response to steering wheel vibration for the valence and arousal affective dimensions is mainly dependent on the vibration intensity of the steering wheel acceleration stimuli. In addition, when vibration stimuli are characterised by similar vibration intensity or similar frequency-band amplitude the emotional response elicited are also similar. While difficult to either prove or disprove based only on the

current data set, it is possible that there are factors other than vibration intensity which influence the human emotional response to steering wheel vibration, such as the presence of high peak events or high frequency band amplitudes.

5. Conclusions

The laboratory-based investigation described in this study was performed to provide an understanding on the factors influencing the emotional state of drivers when driving. The first research question addressed in this current study was what form, if any, of correlation existed between measures of the valence and the arousal dimensions of the human emotional response provided by test participants and the vibration intensity metrics which can be achieved from the steering wheel acceleration signals themselves by means of the unweighted r.m.s., W_h and W_s frequency weighted r.m.s. values. All the data obtained from the current experiment suggest a highly linear correlation between the unweighted, W_h weighted and W_s weighted r.m.s. vibration intensity metrics and the emotional arousal of the human response. Human emotional valence was also found highly linearly correlated with either the unweighted or the frequency weighted vibration intensity metrics, although to a lesser degree than the arousal.

The second research question addressed in the current study was what form of relationship existed between the valence and the arousal dimensions of the human emotional response to steering wheel vibration. Consistent with the underlying bimotivational structure of affective judgement, the results of the current study suggest that the affective space of valence and arousal of steering wheel vibration is characterised by a high-arousal unpleasant feelings. Low intensity steering wheel vibration stimuli with acceleration values less than $0.30 \text{ r.m.s. m/s}^2$, such as those of the tarmac, concrete, slabs, cobblestone and low bump road conditions of the present study, elicited more pleasant and calmer emotional responses than higher intensity steering wheel acceleration stimuli.

Comparison of the results obtained for the different road driving conditions suggests that while vibration intensity plays a significant role in eliciting emotional feelings, there are also other factors which influence the human emotional response to steering wheel vibration such as the presence of high peak events or high frequency band amplitudes. While the current study has provided some first items of information regarding the possible correlation between vibration intensity and human emotional response, further research is required to better understand the effects of the analytical properties of the steering wheel vibration signature such as kurtosis value, frequency band amplitude and time domain features in order to fully identify the signal characteristics which affect the human emotional engagement in current production automobiles.

References

- Ajvalasit, M. and Giacomini, J. (2003) 'Analysis of variations in diesel engine idle vibration', Proceeding of the Institution of Mechanical Engineers Part D 217, 921-933.
- Ajvalasit, M. and Giacomini, J. (2007) 'Effect of automobile operating condition on the subjective equivalence of steering wheel vibration and sound', International Journal of Vehicle Noise and Vibration (IJVNV), Vol. 3, No. 2, pp.197-215.
- Amman, S., Meier, R., Trost, K. and Gu, P. (2005) 'Equal annoyance for steering wheel hand-arm vibration', SAE Paper 2005-01-2473.
- Baddeley, A. (1997) Human Memory: theory and practice, Psychology Press Ltd., Hove, East Sussex.
- Berber, T., Ajvalasit, M., and Giacomini, J. (2010) 'Facilitating the driver detection of road surface type by selective manipulation of the steering wheel acceleration signal', Proceedings of the IMechE, Part D - Journal of Automobile Engineering, Vol. 224, pp.1321-1333.
- Blauert, J. and Jekosch, U. (1997) 'Sound-quality evaluation - A multi-layered problem', Acustica 83: pp.747-753.
- Bradley, M. M. and Lang, P.J. (1994) 'Measuring emotion: The self-assessment manikin and the semantic differential', Journal of Behavioral Therapy and Experimental Psychiatry, 25, pp.49-59.
- Bradley M. M. and Lang, P.J. (2000) 'Affective reactions to acoustic stimuli', Psychophysiology 37: pp.204-215.
- Bolanowski Jr, S.J. and Gescheider, G.A. (1988) 'Four channels mediate the mechanical aspects of touch', J. Acoust. Soc. Am. Vol.84, No.5, pp.1680-1694.
- British Standards Institution BS 6842 (1987) 'Measurement and evaluation of human exposure to vibration transmitted to the hand', British Standards Institution, London.
- British Standards Institution BS7085 (1989) 'Safety aspects of experiments in which people are exposed to mechanical vibration and shock', British Standards Institution, London.
- Cohan, J.A. and Allen, J.B. (2007) Handbook of emotion elicitation and assessment, Oxford University Press, Oxford, UK.
- Department of Transport. Speed Leaflet (2006), <http://www.dft.gov.uk>.
- Erdreich, J. (1986) 'A distribution based definition of impulse noise', J. Acoust. Soc. Am. Vol.79, No.4, pp.990-998.
- Fujikawa, K. (1998) 'Analysis of steering column vibration', Motion & Control 4, pp.37-41.
- Gescheider, A.G. (1997) Psychophysics: The Fundamentals, 3rd Edition, Lawrence Erlbaum Associates Publishers, Mahwah, New Jersey.
- Giacomini, J. and Gnanasekaran, S. (2005) 'Driver estimation of steering wheel vibration intensity: questionnaire-based survey', Journal of the Engineering Integrity Society, 18: pp.23-29.
- Giacomini, J., Shayaa, M.S., Dormegnien, E. and Richard, L. (2004) 'Frequency weighting for the evaluation of steering wheel rotational vibration', International Journal of Industrial Ergonomics, Vol. 33, pp 527-541.
- Giacomini, J., Steinwolf, A. and Staszewski, W.J. (2000) 'An Algorithm for Mildly Non-stationary Mission Synthesis (MNMS)', Eng. Integrity, Vol.7, pp.44-56.

- Gnanasekaran, S., Ajovalasit, M. and Giacomini, J. (2006) 'Driver estimation of steering wheel vibration intensity: laboratory-based tests' *Engineering Integrity*, Vol. 20, September, pp 25-31.
- Greenwald, M. K., Cook, E. W. and Lang, P.J. (1989) 'Affective judgement and psychophysiological response: Dimensional covariation in the evaluation of pictorial stimuli', *Journal of Psychophysiology*, Vol.3, pp.51-64.
- Ho, C., Reed, N., and Spence, C. (2007) 'Multisensory in-car warning signals for collision avoidance', *Human Factors*, Vol.49, No.6, pp.1107-1114.
- Hinton, P.R. (1999) *Statistics explained: a guide for social science students*, Routledge, London.
- International Organization for Standardization (2001) 'Mechanical Vibration - Measurement and assessment of human exposure to hand-transmitted vibration', Part 1: General guidelines. ISO 5349-1. Geneva.
- International Organization for Standardization (2001) 'Mechanical Vibration – Vibrotactile perception thresholds for the assessment of nerve dysfunction', Part1: Methods of measurement at the fingertips, ISO 13091-1, Geneva.
- Lang, P. J., Greenwald, M. K., Bradley M. M. and Hamm, A.O. (1993) 'Looking at pictures: affective, facial, visceral, and behavioral reactions', *Psychophysiology* Vol30, pp.261-273.
- Lee, S. (2006) 'Characterisation of multiple interior noise metrics and translation of the voice of the customer. *International Journal of Vehicle Noise and Vibration (IJVNV)*, Vol. 2, No. 4, pp.341-356.
- Lyon, R. H. (2000) *Designing for product sound quality. Mechanical Engineering*, 127, Marcel Dekker Inc: USA.
- Öhman, A. (1993) 'Fear and anxiety as emotional phenomena: Clinical phenomenology evolutionary perspectives, and information-processing mechanisms', in M. Lewis and J.M. Haviland, *Handbook of emotions*, pp. 511-536. Guilford, New York.
- Pak, C.H., Lee, U.S., Hong, S.C., Song, S.K., Kim, J.H., and Kim, K.S. (1991) 'A study on the tangential vibration of the steering wheel of passenger car', *SAE Paper 912565*: pp.961-968.
- Phelps, E. A., Ling, S., and Carrasco, M. (2006) 'Emotion facilitates perception and potentiates the perceptual benefits of attention', *Psychological Science*, vol.17, pp.292-299.
- LMS International (2002) *LMS Cada-X Fourier Monitor Manual*, Revision 3.5FZ, Leuven.
- McAdams, S. (1993) *Recognition of Auditory Sound Sources and Events. In Thinking in Sound: The Cognitive Psychology of Human Audition*, Oxford University Press, Oxford.
- Penne, F. (2004) 'Shaping the Sound of the Next-Generation BMW', *ISMA 2004 International Conference on Noise and Vibration Engineering*, September 20-22, Katholieke Universiteit Leuven, Belgium.
- Pheasant, S. and Haslegrave, C.M. (2005) *Bodyspace: Anthropometry, Ergonomics and the Design of work*, 3rd Edition, U.S.A., Taylor & Francis.
- Reynolds, D.D. and Keith, R.H. (1997) 'Hand-arm vibration, Part 1: Analytical model of the vibration response characteristics of the hand', *Journal of Sound and Vibration*. Vol.51, No2, pp.237-253.
- Salminen, K., Surakka, V., Lylykangas, J., Raisamo, J., Saarinen, R., et al. (2008) 'Emotional and behavioral responses to haptic stimulation', *Proceedings of the twenty-sixth annual SIGCHI conference on Human factors in computing systems*. Florence, Italy: ACM.

Spence, C., and Ho, C. (2008) 'Tactile and multisensory spatial warning signals for drivers', IEEE Transactions on Haptics, pp.121-129.

van Erp, J. B. F. and van Veen, H. A. H. C. (2004) 'Vibrotactile in-vehicle navigation system', Transportation Research Part F: Traffic Psychology and Behaviour, Vol.7, pp.247–256.

Västfjäll, D. (2003) 'Affect as a component of perceived sound and vibration quality in aircraft', Chalmers University of Technology.

Williams, C.S. (1986) Designing digital filters, Prentice-Hall, Englewood Cliffs, New Jersey.

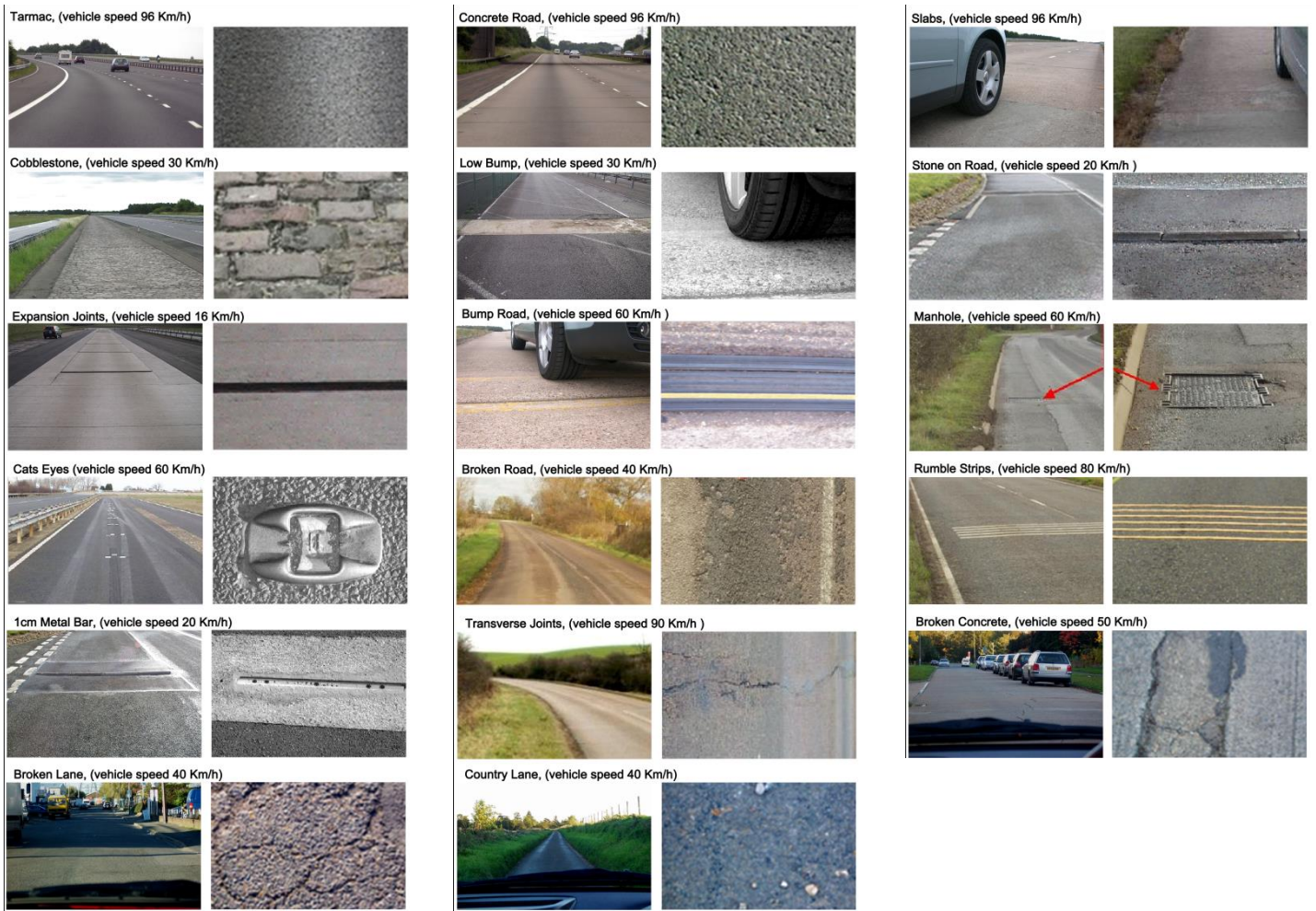

Figure 1. Road surfaces and vehicle speeds whose stimuli were chosen for use in the laboratory tests.

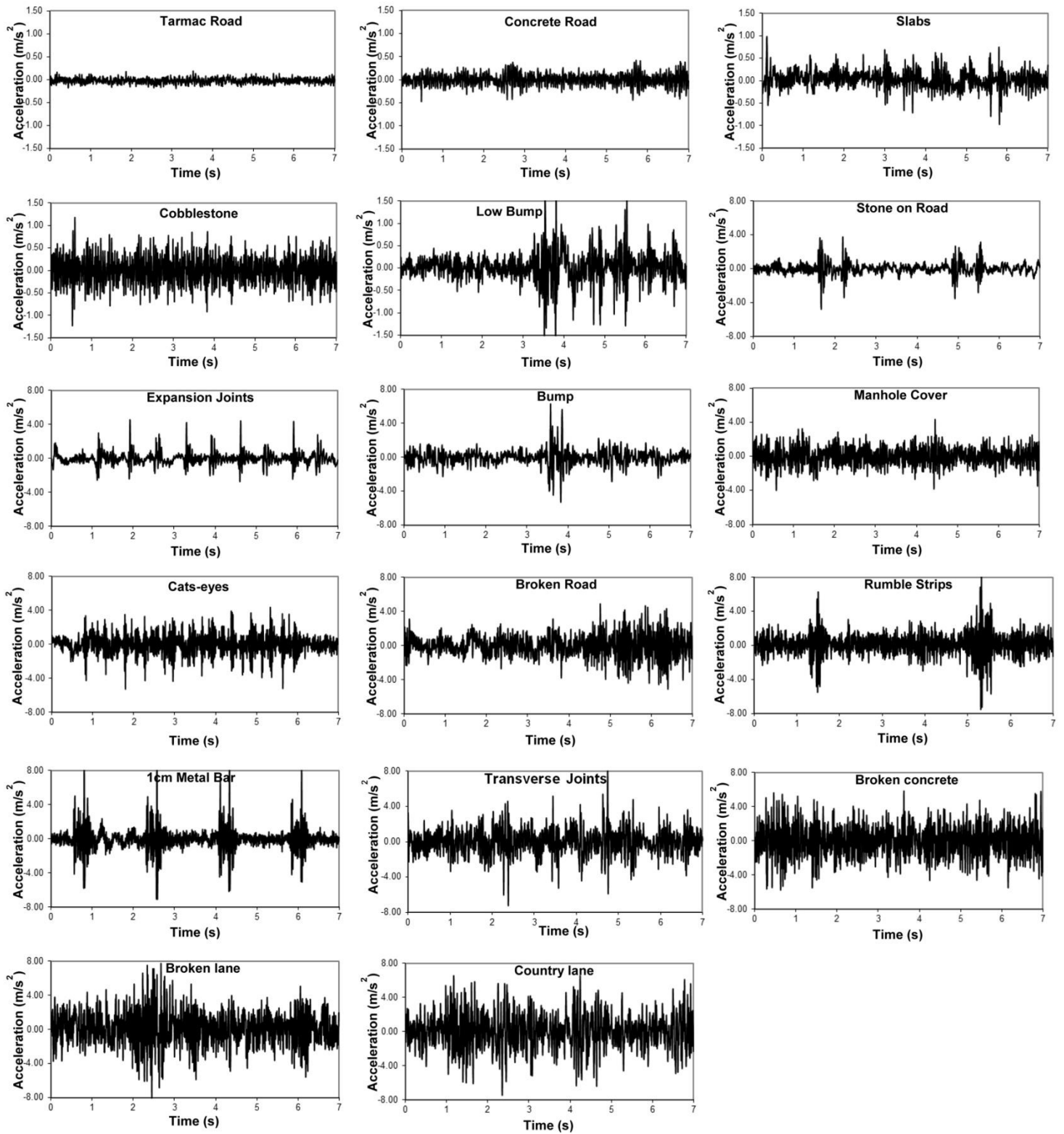

Figure 2. The seventeen steering wheel acceleration time history segments which were extracted from the road test recordings for use as laboratory stimuli.

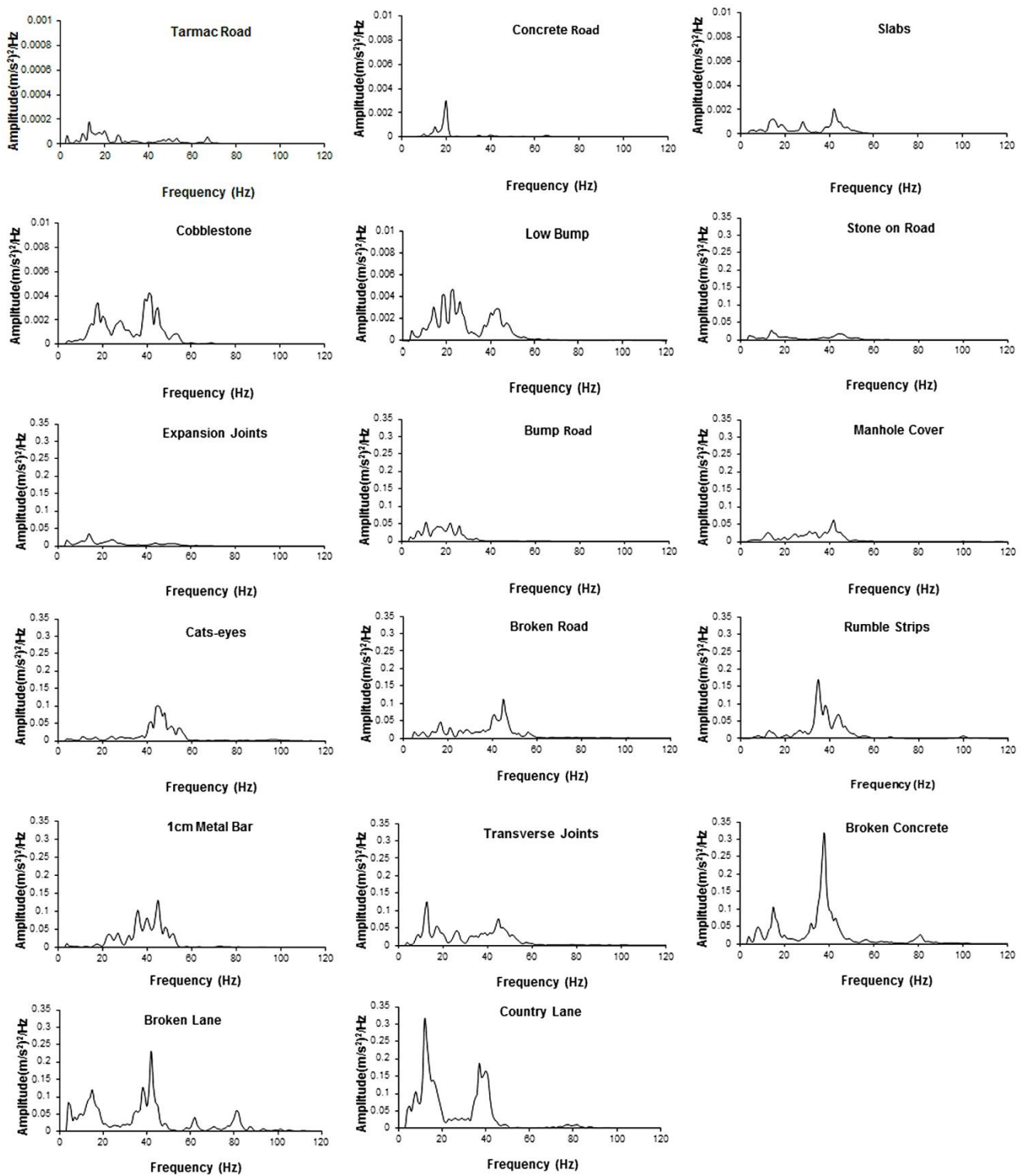

Figure 3. The Power Spectral Densities (PSD) calculated from the seventeen steering wheel acceleration time history segments.

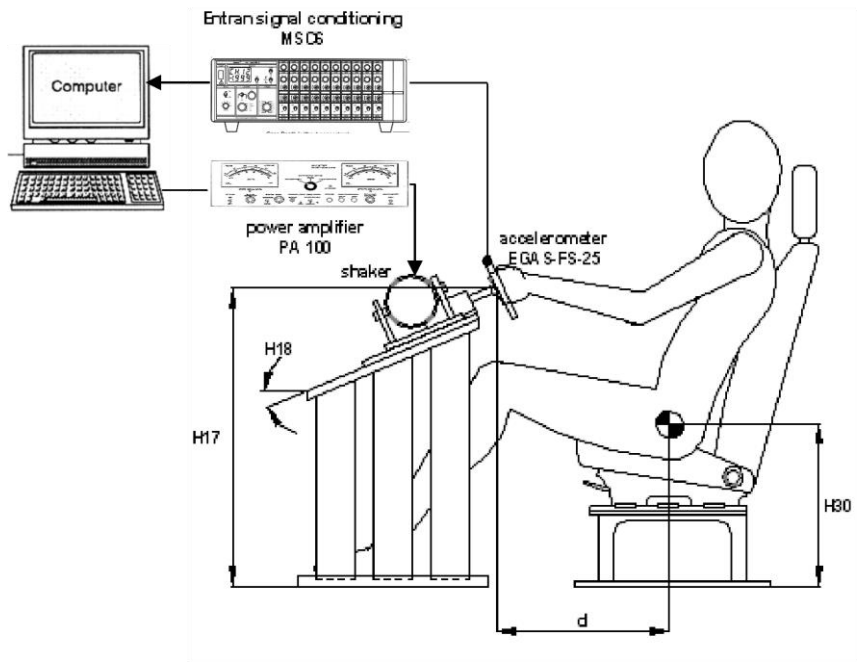

Figure 4. Schematic representation of the steering wheel test rig

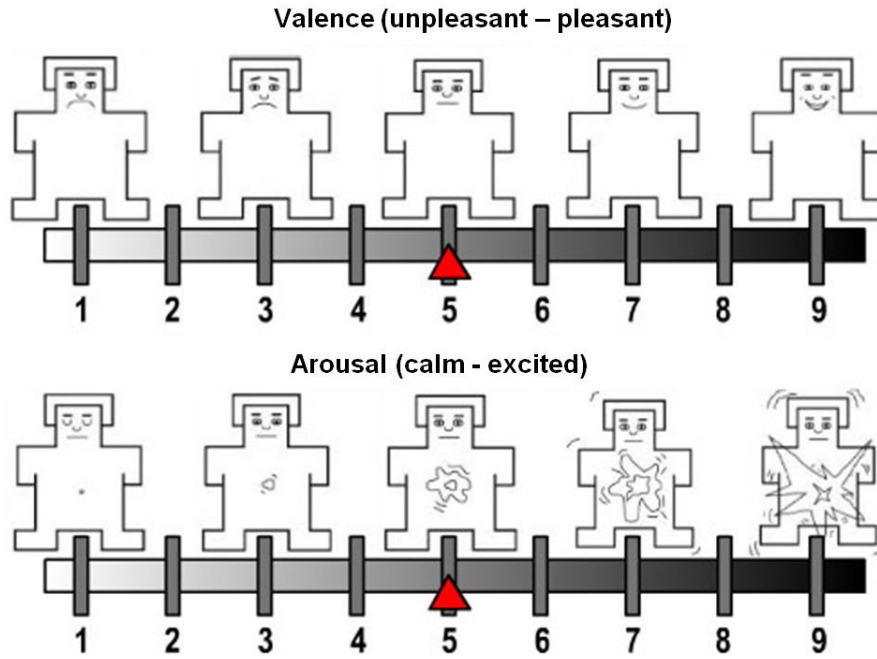

Figure 5 – The Self-Assessment Manikin (SAM) used to rate the affective dimensions of emotional valence (top panel) and emotional arousal (bottom panel). (Adapted from Bradley and Lang, 1994).

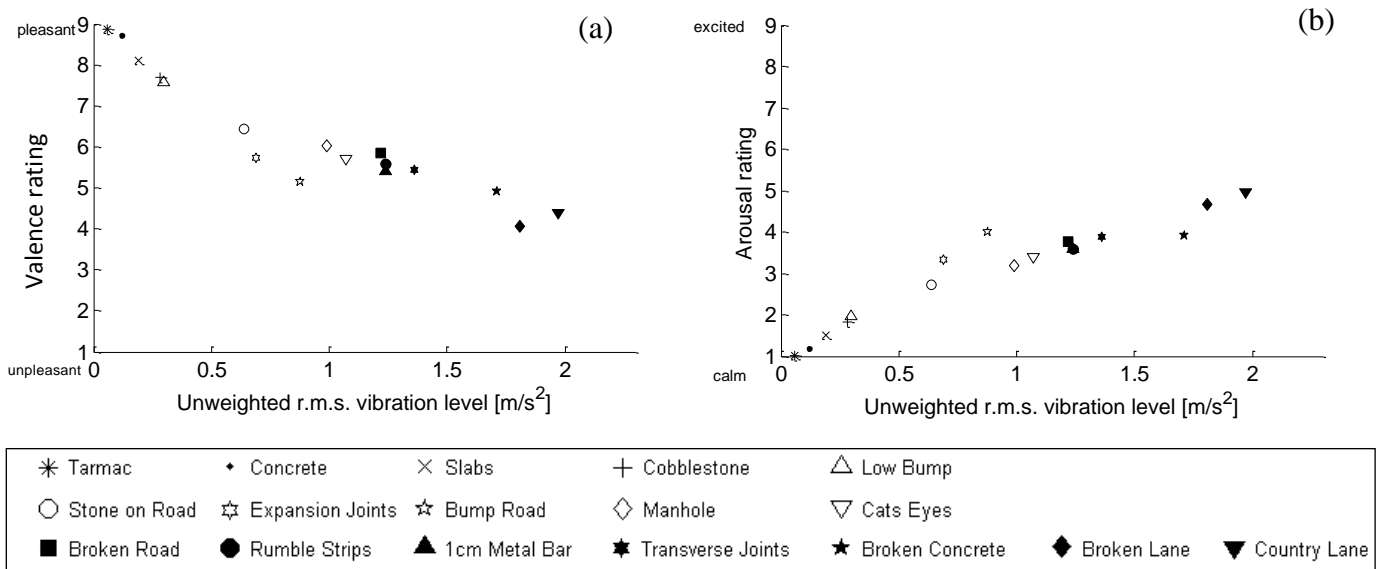

Figure 6 - Mean affective ratings of the seventeen road driving conditions plotted as a function of the unweighted r.m.s. steering wheel acceleration amplitude obtained using SAM rating scale: (a) valence ratings, (b) arousal ratings

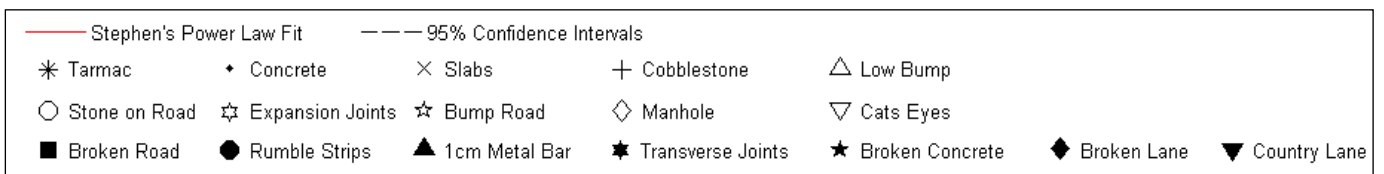
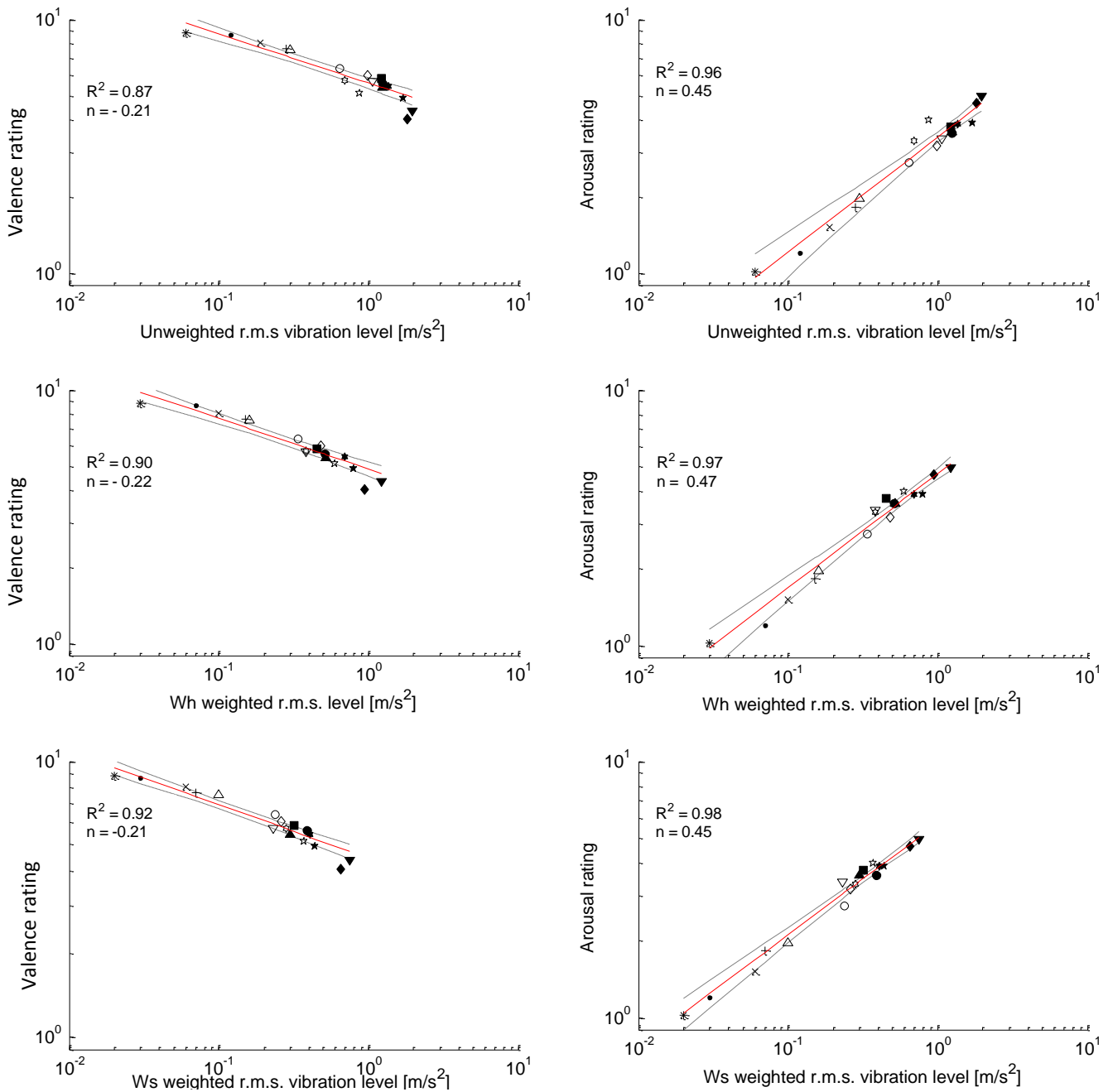

Figure 7 – Growth functions of the human emotional responses of valence and arousal as a function of the unweighted, the Wh weighted and the Ws weighted r.m.s. vibration levels of the seventeen road test stimuli. Data shown the mean affecting ratings of valence and arousal and the 95% confidence intervals of the Stevens' power law fit.

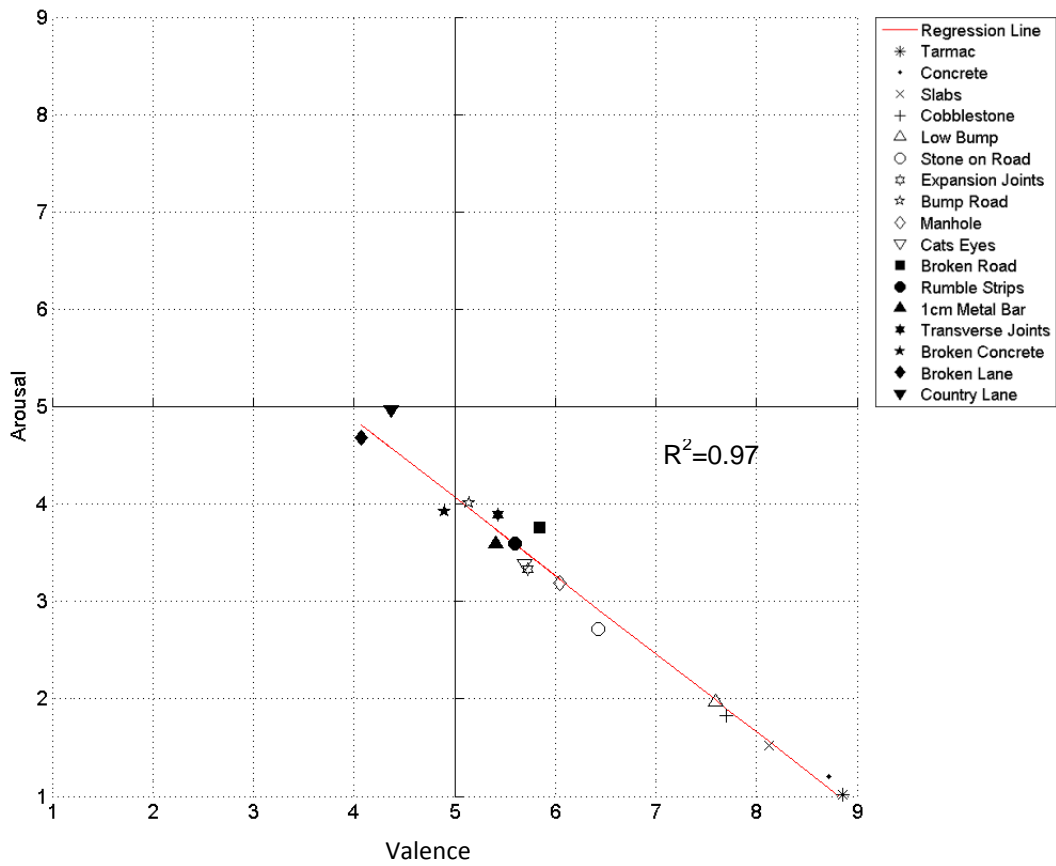

Figure 8 The Two-dimensional affective space defined by the mean ratings of valence and arousal of automotive steering wheel vibration for the seventeen road driving conditions.

Table 1) Global statistical properties of the steering wheel acceleration time histories for the seventeen road driving conditions which were used as test stimuli in the experiments.

Road Surface Type	Speed (km/h)	r.m.s vibration level (m/s ²)	Kurtosis (dimensionless)	Crest factor (dimensionless)
Tarmac	96	0.06	3.09	3.42
Concrete	96	0.12	3.45	3.72
Slabs	96	0.19	5.27	5.28
Cobblestone	30	0.28	3.17	4.27
Low Bump	30	0.30	8.05	6.19
Stone on Road	20	0.64	10.99	6.71
Expansion Joints	16	0.69	10.28	5.24
Bump Road	60	0.88	10.15	6.59
Manhole	60	0.99	3.25	4.18
Cats Eyes	60	1.07	4.67	4.47
Broken Road	40	1.22	3.93	4.1
Rumble Strips	80	1.24	7.76	6.4
1cm Metal Bar	20	1.24	17.12	7.32
Transverse Joints	90	1.36	5.11	5.62
Broken Concrete	50	1.71	3.19	3.38
Broken Lane	40	1.81	3.79	4.32
Country Lane	40	1.97	3.43	3.55

Table 2) Geometric dimensions of the steering wheel rotational vibration test rig.

Geometric Parameter	Value
Steering column angle (H18)	23°
Steering wheel hub centre height above floor (H17)	710 mm
Steering wheel diameter (W9)	325 mm
Steering wheel tube diameter	25 mm
Horizontal distance from H point to steering wheel hub centre (d= L11-L53)	390–550 mm
Seat H point height from floor (H30)	275 mm

Table 3) Physical characteristics of the group of test participants involved in the laboratory experiments (n=30).

Characteristics	Mean	Standard Deviation	Minimum	Maximum
Age (years)	25.5	7.7	20.0	54.0
Height (m)	1.7	0.1	1.5	1.9
Mass (kg)	76.4	17.1	47.0	98.0

Table 4) Root mean square amplitudes of the unweighted, the Wh weighted and the Ws weighted acceleration signals, and corresponding valence and arousal affective ratings (n=30 people) for each of the seventeen road driving conditions used in this study.

Road Surface Type	Unweighted r.m.s (m/s ²)	Wh weighted r.m.s (m/s ²)	Ws weighted r.m.s (m/s ²)	Pleasure rating mean (SD)	Arousal rating mean (SD)
Tarmac	0.06	0.03	0.02	8.86 (0.4)	1.02 (0.1)
Concrete	0.12	0.07	0.03	8.72 (0.7)	1.20 (0.5)
Slabs	0.19	0.10	0.06	8.12 (1.0)	1.52 (0.6)
Cobblestone	0.28	0.15	0.07	7.70 (1.2)	1.83 (0.9)
Low Bump	0.30	0.16	0.10	7.59 (1.1)	1.97 (1.0)
Stone on Road	0.64	0.34	0.24	6.43 (1.1)	2.72 (1.0)
Expansion Joints	0.69	0.38	0.28	5.73 (1.3)	3.33 (1.3)
Bump Road	0.88	0.60	0.37	5.14 (1.5)	4.01 (1.8)
Manhole	0.99	0.48	0.26	6.04 (1.4)	3.19 (1.4)
Cats Eyes	1.07	0.38	0.23	5.70 (1.8)	3.39 (1.8)
Broken Road	1.22	0.45	0.32	5.84 (1.6)	3.76 (1.8)
Rumble Strips	1.24	0.51	0.39	5.60 (1.4)	3.59 (1.5)
1cm Metal Bar	1.24	0.52	0.30	5.41 (1.5)	3.60 (1.6)
Transverse Joints	1.36	0.70	0.41	5.43 (1.7)	3.89 (2.0)
Broken Concrete	1.71	0.80	0.44	4.90 (1.7)	3.92 (1.7)
Broken Lane	1.81	0.94	0.65	4.07 (1.9)	4.68 (1.9)
Country Lane	1.97	1.22	0.75	4.37 (2.0)	4.97 (2.3)

Table 5) Stevens' power exponents n and coefficient of determination R² determined for the affective reactions of valence and arousal and the unweighted and weighted vibration intensity metrics used for automotive steering wheel vibration.

Vibration intensity metric [m/s ²]	Affective dimension			
	Pleasure		Arousal	
	Stevens' Power Exponent, n	Coefficient of determination, R ² **	Stevens' Power Exponent, n	Coefficient of determination, R ² **
Unweighted rms	-0.21	0.87	0.45	0.96
Wh weighted rms	-0.22	0.90	0.47	0.97
Ws weighted rms	-0.21	0.92	0.45	0.98

** p < 0.01