

**Novel Processes for Smart Grid
Information Exchange and
Knowledge Representation
using the IEC Common
Information Model**

A thesis submitted for the degree of Doctor of Philosophy

by

Nigel Hargreaves

Supervised by Dr. G. A. Taylor

Department of Electronic and Computer Engineering

Brunel University

ABSTRACT

The IEC Common Information Model (CIM) is of central importance in enabling smart grid interoperability. Its continual development aims to meet the needs of the smart grid for semantic understanding and knowledge representation for a widening domain of resources and processes. With smart grid evolution the importance of information and data management has become an increasingly pressing issue not only because far more data is being generated using modern sensing, control and measuring devices but also because information is now becoming recognised as the 'integral component' that facilitates the optimal flexibility required of the smart grid.

This thesis looks at the impacts of CIM implementation upon the landscape of smart grid issues and presents research from within National Grid contributing to three key areas in support of further CIM deployment. Taking the issue of Enterprise Information Management first, an information management framework is presented for CIM deployment at National Grid. Following this the development and demonstration of a novel secure cloud computing platform to handle such information is described.

Power system application (PSA) models of the grid are partial knowledge representations of a shared reality. To develop the completeness of our understanding of this reality it is necessary to combine these representations. The second research contribution reports on a novel methodology for a CIM-based model repository to align PSA representations and provide a knowledge resource for building utility business intelligence of the grid.

The third contribution addresses the need for greater integration of information relating to energy storage, an essential aspect of smart energy management. It presents the strategic rationale for integrated energy modeling and a novel extension to the existing CIM standards for modeling grid-scale energy storage. Significantly, this work has already contributed to a larger body of work on modeling Distributed Energy Resources currently under development at the Electric Power Research Institute (EPRI) in the USA.

ACKNOWLEDGEMENTS

I would like to express my gratitude to Dr. Gareth A. Taylor for initiating this research project and for his guidance and encouragement throughout the duration of my research into this topic. My deep appreciation also goes to Mr. Stefan Pantea for his valuable suggestions and comradeship during my PhD studies. I am also grateful to Dr. Alex Carter, Mr. Barry Lewis, Mr. Parry Batth, Dr. Ronan Jamieson and Dr. Bernie Dolan for their valuable insights and suggestions throughout my presence at Electricity National Control Centre.

I gratefully acknowledge the financial support I have received from Dr. Martin Bradley on behalf of National Grid Plc. and the Engineering and Physical Sciences Research Council (EPSRC) for sponsoring me throughout the last three years.

Finally, I would like to thank Sargam and my family, for their love, support, patience and understanding.

DECLARATION

The work described in this thesis has not been previously submitted for a degree in this or any other university and unless otherwise referenced it is the author's own work.

STATEMENT OF COPYRIGHT

The copyright of this thesis rests with the author. No parts from it should be published without his prior written consent, and information derived from it should be acknowledged.

©COPYRIGHT NIGEL B. HARGREAVES

All Right Reserved

TABLE OF CONTENTS

ABSTRACT	ii
ACKNOWLEDGMENTS	iii
DECLARATION	iv
STATEMENT OF COPYRIGHT	v
TABLE OF CONTENTS	vi
LIST OF TABLES	x
LIST OF FIGURES	xi
LIST OF ABBREVIATIONS	xiv
DEFINITIONS	xviii
1 INTRODUCTION	
1.1 Context and research motivation	1
1.1.1 Regulatory framework.....	1
1.1.2 Security of supply.....	2
1.1.3 Energy security.....	3
1.1.4 Electrical power networks infrastructure lifecycle.....	4
1.2 Problem statement and rationale	5
1.3 Principal research contributions	9
1.4 List of publications	12
1.4.1 Journal publication.....	12
1.4.2 Book chapter.....	12
1.4.3 Conference publications.....	12
1.4.4 Invited presentation.....	13
1.5 Thesis outline	13
2 THE IEC CIM IN CONTEXT	
2.1 Introduction	15
2.2 The smart grid concept	15
2.3 Interoperability and Service Oriented Architecture	17
2.4 Use Cases	27
2.5 Standards architecture	28
2.6 A critical review of the IEC Common Information Model	31
2.6.1 Knowledge representation.....	35

2.6.2	Information integration.....	37
2.6.3	Enterprise information management and business cases.....	42
2.7	Chapter summary	51
3	NOVEL EIM STRATEGIES FOR NATIONAL GRID	
3.1	Introduction	55
3.1.1	National Grid and the GB electrical power network.....	55
3.2	Motivation for MDI	57
3.3	Approaching CIM implementation	61
3.4	EIM for National Grid	64
3.4.1	National Grid transmission information management framework.....	65
3.4.2	Ten step CIM implementation plan.....	67
3.4.3	Current CIM deployment at National Grid.....	68
3.4.4	A high-level SOA for National Grid.....	70
3.5	Chapter summary	73
4	ADDRESSING EMERGING SMART GRID OPERATIONAL REALITIES	
4.1	Introduction	75
4.2	Emerging smart grid operational realities at National Grid	75
4.3	Cloud computing and EIM for the smart grid	82
4.4	Cloud computing trust and privacy considerations	84
4.5	Development and demonstration of myTrustedCloud	85
4.5.1	Use case analysis.....	86
4.5.2	Provenance of mTC cloud infrastructure and services.....	89
4.5.3	Application of mTC to the use case.....	92
4.5.4	Analysis of performance, threats and vulnerabilities.....	97
4.6	Further work	98
4.7	Chapter summary	100
5	A METAMODEL REPOSITORY FOR USE WITH THE IEC CIM	
5.1	Introduction	102
5.2	Data, information, knowledge and intelligence	102
5.3	Placing the CIM in a knowledge framework context	105
5.4	Data ambiguities and collisions	110

5.4.1	Naming and identity ambiguity.....	110
5.4.2	Context and meaning ambiguity.....	113
5.5	Research motivation.....	115
5.6	Use cases considered for model repository demonstration.....	116
5.7	Repository methodology.....	120
5.7.1	Repository model management process.....	123
5.7.2	Repository maintenance through time.....	130
5.8	Further work.....	132
5.9	Chapter summary.....	134
6	EXTENSION OF IEC61970 FOR ELECTRICITY STORAGE MODELLING	
6.1	Introduction.....	136
6.2	Balancing the grid: future energy scheduling challenges.....	136
6.3	Research motivation.....	140
6.4	Placing EES in context.....	142
6.5	Roles for EES technologies.....	145
6.6	Use cases for EES technologies.....	148
6.7	Proposed model extension to IEC 61970 for EES.....	149
6.7.1	Current provision for energy storage within IEC 61970.....	149
6.7.2	Design for novel energy storage model.....	153
6.8	Further work.....	160
6.9	Chapter summary.....	161
7	CONCLUSIONS AND FURTHER WORK	
7.1	Conclusions.....	163
7.1.1	Novel EIM strategies for National Grid.....	163
7.1.2	A secure cloud computing infrastructure solution.....	164
7.1.3	Design methodology and demonstration of a metamodel repository.....	164
7.1.4	Extension of IEC 61970 for electricity storage modelling.....	165
7.2	Further work.....	165
7.2.1	Utility information exchange through the cloud.....	165

7.2.2 Metamodel repository.....	166
7.2.3 IEC CIM extension – energy storage modelling.....	167
REFERENCES.....	168
APPENDIX	
Conferences and Curricular Modules attended.....	188

LIST OF TABLES

Table 1. Analysis of reported business cases for IEC CIM deployment.....	48
Table 2. CIM 15 naming architecture with brief description.....	112
Table 3. Scenarios and solutions relating to temporal model management within the repository.....	132
Table 4. Established and emerging roles for different types of EES system.....	147

LIST OF FIGURES

Fig. 1.	The GridWise® interoperability Context-setting Framework.....	19
Fig. 2.	The Level of Conceptual Interoperability Model.....	22
Fig. 3.	IEC/TR 62357 Reference Architecture.....	29
Fig. 4.	DNOs in the UK.....	57
Fig. 5.	Business process decomposition.....	58
Fig. 6.	A typical smart grid organisational architecture.....	59
Fig. 7.	A simplified representation of IEC TR 62357-1.....	60
Fig. 8.	Key aspects of enterprise information modelling process.....	62
Fig. 9.	Key aspects of enterprise information integration process.....	63
Fig. 10.	Transmission information management framework for National Grid.....	66
Fig. 11.	Ten-step high-level CIM implementation plan.....	67
Fig. 12.	Current status of CIM interface development at National Grid.....	68
Fig. 13.	Key National Grid operational system interfaces.....	71
Fig. 14.	Potential evolution of National Grid operational PSA information architecture to SOA.....	72
Fig. 15.	Very large scale transnational SOA.....	73
Fig. 16.	Weather dependency of modern electrical power networks.....	77
Fig. 17.	National Demand Forecast and Indicated Generation Forecast.....	79
Fig. 18.	A demand day scenario projected against generation with a high proportion of VERs.....	80
Fig. 19.	Operational envelopes for system balancing at National Grid.....	81
Fig. 20.	Relationship between traditional and cloud computing environments.....	82
Fig. 21.	DNO to National Grid planning model exchange process.....	86
Fig. 22.	National Grid to Coreso planning model exchange process.....	87
Fig. 23.	Overview of mTC project infrastructure.....	89
Fig. 24.	Logical organisation of mTC services infrastructure.....	90
Fig. 25.	DNO CIM data model upload to myTrustedCloud.....	93
Fig. 26.	National Grid CIM data model merge and conversion within myTrustedCloud.....	93
Fig. 27.	Validation log from Eucalyptus on VM instantiation.....	95

Fig. 28. Selection of the validation profile from within Cimphony.....	96
Fig. 29. Validation log from Eucalyptus on VM instantiation.....	97
Fig. 30. Grid-user data service.....	99
Fig. 31. The ascent of data in support of business intelligence and decision making.....	103
Fig. 32a. Ogden and Richards' "Meaning Triangle".....	105
Fig. 32b. Ogden and Richards' "Meaning Triangle" applied to modelling....	105
Fig. 33. Application of the Meaning Triangle to a power system model context.....	106
Fig. 34. Application of the OMG 'Four-layer Hierarchy' to a power system model context.....	107
Fig. 35. Conceptualisation of composite data model with data ownership pattern.....	109
Fig. 36. Conceptual model naming management infrastructure.....	111
Fig. 37. UML naming architecture within IEC CIM 15.....	112
Fig. 38. Resource recognition and containment with modelling reference architecture.....	114
Fig. 39. Schematic representation of EMS-EBS-DH use case.....	117
Fig. 40. Schematics of use case scenarios.....	118
Fig. 41. Model alignment principle within repository.....	120
Fig. 42. IEC61970-301 metamodel architecture for relevant sections of merged models.....	122
Fig. 43. Repository file tree of containment structure for model sections used in demonstration.....	123
Fig. 44. Repository model management process.....	124
Fig. 45. Master Model 1.....	125
Fig. 46. Slave Model 2.....	126
Fig. 47. Slave "rdf:DifferenceModel".....	127
Fig. 48. Object identity rotation process on Slave model import and export from repository.....	128
Fig. 49. Screen shots from model handling tool.....	129
Fig. 50. Some emerging probabilistic inputs to multi-factorial energy forecasting by TSOs.....	137
Fig. 51. Simplified representation of EES systems in smart grid balancing	

role.....	141
Fig. 52. Holistic perspective of methods relating to energy storage modelling.....	143
Fig. 53. Deployment characteristics of common EES technologies (not to scale).....	145
Fig. 54. Comparison of rated power, energy capacity and discharge time for different energy storage technologies.....	146
Fig. 55. IEC CIM Standard 61970-301.....	150
Fig. 56. Generation main model diagram.....	151
Fig. 57. Regulating equipment model from CIM 15.....	152
Fig. 58. CIM 15 packages showing ESM package extension.....	154
Fig. 59. Hydro and pumped hydro model from CIM 15.....	155
Fig. 60. Proposed ESM UML class diagram.....	156

LIST OF ABBREVIATIONS

AMI	: Advanced Metering Infrastructure
BPM	: Business Process Management
CIGRE	: Council on Large Electric Systems
CIM	: Common Information Model (IEC 61970/61968/62325)
CDPSM	: Common Distribution Power System Model (IEC 61968-13)
COSEM	: Companion Specification for Energy Metering
COTS	: Commercial Off-The-Shelf
CPSM	: Common Power System Model (IEC 61970-452)
CRTM	: Core Root of Trust for Measurement
DA	: Distribution Automation
DARM	: Dynamic Asset and Risk Management
DER	: Distributed Energy Resource
DEAF	: Demand Energy Analysis and Forecasting
DH	: National Grid Data Historian (a form of data warehouse)
DIPA	: Data Integration and Process Automation
DLMS	: Device Language Message Specification
DMS	: Distribution Management System
DNO	: Distribution Network Owner
DoE	: US Department of Energy
DSO	: Distribution System Operator
DSR	: Demand-side Response
E2E	: End-to-End
EAI	: Enterprise Application Integration
EBS	: Energy Balancing System
EBS ₁	: Elastic Block Storage
EC	: European Commission
EDM	: Enterprise Data Model
EG	: Embedded Generation
EGI	: Equipment Group Identifier
EIC	: Energy Identification Code
EIM	: Enterprise Information Management
Ellipse	: A proprietary asset database system

EMS	: Energy Management System (also IEMS)
ENSG	: Electricity Networks Strategy Group
ENTSOE	: European Network of Transmission System Operators for Electricity
EPRI	: Electric Power Research Institute
ERCOT	: Electric Reliability Council of Texas
EES	: Electrical Energy Storage
ESB	: Enterprise Service Bus
ESM	: Enterprise Semantic Model
EVE	: A proprietary electronic charging and billing system
FACTS	: Flexible Alternating Current Transmission Systems
GIS	: Graphical Information System
GRUB	: Grand Unified Bootloader
GWAC	: GridWise® Architecture Council
HVDC	: High Voltage Direct Current
ICT	: Information and Communications Technology
IEC	: International Electrotechnical Commission
IED	: Intelligent Electronic Device
JWG	: Joint Working Group
KR	: Knowledge Representation
LCIM	: Levels of Conceptual Interoperability Model
LIPA	: Long Island Power Authority
M2M	: Machine-to-Machine
MDA	: Model Driven Architecture
MDE	: Model Driven Engineering
MDI	: Model Driven Integration
MMS	: Market Management System
NASAP	: Network Analysis and Systems Application Program
NC	: Node Controller
NED	: National Grid Economic Data Warehouse
NG	: National Grid
NMMS	: Network Model Management System
NOCC	: National Operational Control Centre
OFTO	: Offshore Transmission System Owner

OMG	: Object Management Group
ONCOR	: Oncor Electric Delivery Company
OPC	: Open Platform for Communications
OWL	: Web Ontology Language
PAP	: Priority Action Program
PAS	: Publicly Available Specification
PCR	: Platform Configuration Register
POND	: Planning and Operational Database
PMU	: Phasor Measurement Unit
PSA	: Power System Application
PSS®E	: Power System Simulator for Engineering
RDB	: Registration Data Base
RET	: Renewable Energy Technology
RTO	: Regional Transmission System Operator
SC	: Storage Controller
SDO	: Standards Development Organisation
SGAM	: Smart Grid Architecture Model
SG-CG	: Smart Grid Coordination Group (CEN-CENELEC-ETSI)
SGIRM	: Smart Grid Interoperability Reference Model (IEEE)
SIA	: Seamless Integration Architecture
SO	: System Operator
SOA	: Service Oriented Architecture
SPARQL	: SPARQL Protocol and RDF Query Language
SSO	: Standards Setting Organisation
STOR	: Short Term Operating Reserve
TCG	: Trusted Computing Group
TO	: Transmission System Owner
TOGA	: Transmission Outage Generator Availability
TPM	: Trusted Platform Module
TSC	: Transmission System Operator Security Cooperation
TSO	: Transmission System Operator
UA	: Unified Architecture
UKPN	: UK Power Networks
UML	: Unified Modeling Language

UUID	: Universally Unique Identifier
VER	: Variable Energy Resource
VLPGO	: Very Large Power Grid Operators
VM	: Virtual Machine
WSDL	: Web Service Description Language
WSML	: Web Service Modeling Language
XSD	: XML Schema Definition

DEFINITIONS

- Architecture : The conceptual structure and overall organization of an entity from the point of view of its use or design. The architecture embodies high-level principles and requirements that designs of Smart Grid applications and systems must satisfy. [1]
- Harmonisation : The process of achieving technical equivalency and enabling interchangeability between different standards with overlapping functionality. Harmonization requires an architecture that documents key points of interoperability and associated interfaces. [42]
- Infrastructure : The physical and organizational mechanism supporting the operation and functions of a dependent system, enterprise or organisation.
- Interchangeability : An extreme degree of interoperability characterized by a similarity sometimes termed “plug and play.” Interchangeable components can be freely substituted without loss of function and requiring minimum no additional configuration. [79]
- Interoperability : The capability of two or more networks, systems, devices, applications, or components to exchange and readily use information, securely and effectively, even though they may be using a variety of different information systems and infrastructures and possibly from different regions. [79][93]
- Metamodel : A model of models [2]. A specification model for which the systems under study being specified are models in a certain modeling language [3].
- Model : “An abstraction of reality according to a certain conceptualisation” [4]. “An abstraction of a (real or

language-based) system allowing predictions or inferences to be made” [5].

Ontology : A formal specification of a representational vocabulary for a shared domain of discourse. An explicit specification of a shared conceptualisation [6]

Reference Model : A set of views (diagrams) and descriptions that provides the basis for discussing the characteristics, uses, behavior, interfaces, requirements, and standards of an entity.

Standards : “Specifications that establish the fitness of a product for a particular use or that define the function and performance of a device or system.” [42]

CHAPTER 1

INTRODUCTION

1.1 Context and research motivation

The following sections will outline the key drivers behind this research and set the context for the research contributions in the following chapters.

1.1.1 Regulatory framework

The UK Government and European Parliament have set challenging targets for decarbonisation of greenhouse gas emissions which impact heavily upon the electricity industry. The *Energy White Paper* of 2007, the *Climate Change Act* of 2008, the *Low Carbon Transition Plan* of 2009 and the *Renewable Energy Roadmap* of 2011 set out the UK energy decarbonisation strategy and its justification [7,8,9,10]. The keynote of these documents is that the Government has legally bound itself to reduce UK carbon emissions by at least 80% compared to 1990 levels by 2050.

In this document reference to National Grid is intended to mean the electricity and gas Transmission System Owner (TSO) for England and Wales as well as the GB electricity transmission System Operator (SO). As part of the Electricity Networks Strategy Group (ENSG), National Grid have worked in collaboration with the Government, Ofgem (the electricity and gas regulatory authority in Great Britain) and other companies to produce a vision for electricity networks to meet the 2020 renewable energy target set out within the Low Carbon Transition Plan. This vision is described in a number of National Grid documents [11][12] based on their “*Initial Consultation: Operating the Electricity Transmission Networks in 2020*” [13].

For its part in achieving a global warming stabilization temperature of +2°C (compared with pre-industrial times) by 2100, the European Council in 2011 reconfirmed its objective for the European Union (EU) countries to reduce their greenhouse gas emissions by 80-95% by 2050 compared to 1990 levels. In their *Roadmap for moving to a competitive low carbon economy in 2050* [14] they identified ‘Climate and Energy’ as one of five headline targets within the *Europe 2020 Strategy* for smart, sustainable and

inclusive growth. The challenges and technologies for moving to a decarbonised energy supply for Europe are further explored in the subsidiary *Energy Roadmap 2050* [15].

Carrying forward these directives, the European Network of Transmission System Operators for Electricity (ENTSOE) has published its latest *Ten-Year Development Plan* [16] detailing the anticipated investments in member states' electricity transmission systems to support coordinated development of a pan-European supergrid. Key aspects of these biannual plans address a pan-European Market Database, creation of pan-European Network Models and criteria for assessing the benefits of new transmission projects. To simplify the complexity of these issues, ENTSOE working groups have defined six regional transmission system groupings by member nation. The GB system is part of the North Sea regional group, along with transmission systems belonging to Ireland (north and south) Norway, Denmark, Germany, Netherlands, Belgium, Luxemburg and France.

Independent from ENTSOE, National Grid have entered into a commercial arrangement with TSOs from France (RTE), Belgium (Elia), North and East Germany (50Hertz) and Italy (Terna), managed by Coreso. Coreso is a Regional Coordination Service Centre that aims to improve the security of supply in Western Europe by monitoring the interconnection flows between member transmission systems [17]. Coreso and *TSO Security Cooperation* (TSC) [18] another Regional Coordination Service Centre serving Central European TSOs, form another layer in an increasingly complex matrix of supervision and control of Europe's electricity networks.

1.1.2 Security of supply

Security of supply was a major factor influencing the implementation of a national grid, a move away from the original pattern of distributed, localised generation and supply, often at a municipal level. The move to centralised generation, close to coal supplies and major loads, with radial grid development provided a degree of inter-connection as well as bringing electricity to wider areas of the nation. Both of these offered an improved and cheaper supply to consumers as well as bringing benefits of more consistent

quality and constancy due to the centralised coordination of the national network. Today the issue of security of supply remains a forefront challenge as we see a revival of large amounts of distributed generation and a redefined role for electricity as a principal vector of low carbon energy to assist in the decarbonisation of other sectors, such as transport, residential heating and industry. To fund these, the Government is seeking £110 billion of private investment through public consultation on Electricity Market Reform [19].

As we move to an operating model with greater integration of renewable energy sources and a reduced dependency on centralised coal and oil generation, emergent electricity networks and markets are of increasing complexity, interconnectivity and interoperability. While Flexible Alternating Current Transmission Systems (FACTS) are considered normal these days, with the integration of increasingly large injections from variable energy resources (VERs) [20] and interconnection through high voltage DC (HVDC) transmission networks, they are required to be smarter. We shall look at the meaning of *smart grids* in further detail and how this research contributes to their development in the next chapter.

1.1.3 Energy security

Imports of primary fossil fuel-based energy (eg. coal, petroleum and gas) to the UK have been rising dramatically since 2004 with net imports standing at 37% in 2011 [21]. It is estimated that the UK will import around 80% of its gas needs by 2015 [22]. The European Commission estimates that gas imports as a proportion of Europe's total gas supplies will increase from 61% to 84% by 2030 [23]. With demand for gas heating and gas-fired electricity generation increasing, as coal-fired generation is decommissioned in all National Grid projections to 2030 [5], our reliance upon gas imports poses a critical challenge to UK energy security and further increases the requirement for efficient and flexible electricity networks.

1.1.4 Electrical power networks infrastructure lifecycle

Most of the UK electricity transmission infrastructure and much of its generating plant was conceived of and constructed 45 years ago in times when emissions such as greenhouse gases were not engineering design considerations. With the lifecycle of electrical infrastructure being about 40 years and the changes in operating model upon us, it is not surprising that there is now a requirement for heavy investment in our electricity and gas network infrastructure. For example, Ofgem's 'Project Discovery' found the need for £200 billion investment over the next 10 years to provide the UK with sustainable energy, of which £32 billion, representing 75% of the current value of our energy infrastructure, would fall within their remit [24]. The Electricity Networks Strategy Group (ENSG) reported that under 'Project Delivery', GB network capacity currently under construction, equaled 10.8GW with another 26GW in planning and pre-planning stages [25].

National Grid, working with other energy companies, the Government regulator, Ofgem and the ENSG have responded to the Government's lead by creating their *Gone Green* strategy, which addresses high level issues for the GB transmission system up to 2020 and beyond. Broadly reflecting the make-up of UK electricity generation laid out in the Government's Low Carbon transition plan (above), if implemented it anticipates the following key features:

- Connection to 32GW of wind power by 2020.
- Unprecedented change in the generation fleet, comprising closure of old fossil fuel and nuclear plant – the 'pinch years' in generating capacity will be around 2016-2018.
- Connection of an unspecified number of larger new-nuclear plants and 12GW of new gas-fired plant.
- The need for doubling the amount of Short Term Operating Reserve Requirement (STORR) from 4GW to 8GW to cope with the intermittency injected into the supply side by a greater proportion of renewables (principally wind).
- An enhanced role for international interconnectors to help in electricity balancing.

- The need to reinforce the GB network from north to south by introducing HVDC ‘bootstraps’ to the HVAC system off the east and west coasts, creating a challenging stability management scenario.
- An increasing amount of HVDC interconnection between offshore windfarms and the GB mainland.
- Distribution networks will move from radial to meshed topologies with complex load flows as they need to connect to greater amounts of embedded generation.
- Day to day operation and forecasting of the transmission network will become more probabilistic and risk-based as the impacts of market mechanisms and environmental dependency increase.
- The need to balance greater fluctuations in demand with supply, requiring more precise operational control tools. It is conceivable that the culture of ‘supply-to-demand’ balancing may prioritise the availability of supply over demand in future, requiring more sophisticated control solutions and smarter grids to manage demand.
- Changes to traditional patterns of demand due to the introduction of active and passive demand management.
- The use of tariffs by energy suppliers to encourage consumers to optimise energy use and electric vehicle charging, creating more dependency on smart grid technology

1.2 Problem Statement and Rationale

The scope of changes to the electricity industry outlined above as part of the call for a more sustainable energy system demands an unprecedented synergy between infrastructure, markets, consumers, generators, the environment and people. Linking these together with the anticipated data explosion arising from the deployment of an advanced metering infrastructure (AMI) critically depends upon *interoperability* supported by shared information exchange between the power system applications (PSAs) that are responsible for managing these domains. Here we face a problem in that PSAs were not originally designed to openly share information beyond point-point functionality, having a scope generally limited to isolated business domains within the power utility. Power utility information architecture was

also not intended to support interoperability in the way the new paradigm for electricity management requires.

Interoperability applies at a number of levels within the context of the smart grid but the focus of this thesis addresses the development and use of the International Electrotechnical Commission (IEC) Common Information Model (CIM) for the purpose of supporting PSA interoperability at the semantic informational level (see Fig. 2). While this research was carried out within the network operational and planning domains of National Grid at the GB electricity National Operational Control Centre (NOCC) it has relevance to the wider electricity utility community.

To understand its relevance to the smart grid and its potential for supporting interoperability the first part of the thesis will examine conceptual models of the smart grid to locate the role and position of the CIM and associated open standards. A closer exploration of what is meant by interoperability is also necessary to realise its impact upon electrical utility functionality. Of increasing importance is the interoperable sharing of network models between two or more utilities, such as between a TSO and a Distribution Network Owner/Operator (DNO). To support the increased flexibility of network management required by the smart grid it is anticipated the frequency with which TSOs and DNOs exchange and share information will increase dramatically. They will also need to share information with other parties as well, including generators and Offshore Transmission System Owners (OFTOs). Currently in the UK, a secure information interoperability infrastructure for sharing standardised network models between these parties does not exist. To address this problem this research contributed to the development and demonstration of a trusted cloud infrastructure that could be developed by utilities to share network models and other commonly required environmental and demand-related data.

The focus of the research following this explores the issue of interoperability more deeply. A key challenge to CIM deployment, and therefore interoperability, is the management of heterogeneous resource identifications. The CIM accommodates views of electrical networks both in concrete and conceptual object-oriented terms. Concrete objects relate to connectable hardware such as transformers, substations, lines etc.

Conceptual objects relate to equipment containers, geographic regions, nodal representations of connectivity and topology. Components of both concrete and conceptual representations of PSA models in the CIM are referred to as *power system resources*. They are given names and identities by the various business processes and PSAs they derive from.

Part of the legacy of non-interoperating business processes and PSAs is siloed and duplicated data representing the same power system resource. An important example of this scenario is the often-cited divergence between parameter values of the utility online Energy Management System (EMS) and the offline-planning model, used for load flow, security and contingency studies. We can expect to find instances of name and identity differing between representations of the same power system resources within the databases of these PSAs. These differences compound the problem of aligning and synchronizing the parameter values associated to a common power system resource. Another example of these differences could be found in the planning models utilities are required to exchange relating to a shared piece of network. To address this issue a foundation for utility information interoperability is discussed and a resource naming management architecture is proposed.

Continuing the theme of resource identity alignment, the implementation of the IEC CIM has now made semantic understanding possible in PSA information exchanges. This is an advance on a syntactic level of organisation that has already been achieved through messaging protocols. The use of a model repository can leverage this degree of interoperability as a central component of information management architecture, however applications at a semantic level of interoperability are still relatively new within the power industry. The approach described in this thesis differs from previous implementations in the way it manages resource identification heterogeneity within the models served. It challenges the established approach of using a single CIM XML *namespace* to contain all communicated models comprising the master repository model. In proposing the use of multiple namespaces to contain each model merged into the repository it also offers a more realistic representation of the network provided by individual PSA models. To achieve this, the built-in capabilities of

Resource Description Framework (RDF) and eXtended Markup Language (XML) technologies have been fully exploited. A model architecture referenced to an established hierarchy owned by the Object Management Group (OMG) was developed to explain how this architecture interfaces across levels of abstraction from data acquisition to the enterprise data model. This opens up the opportunity to build a more realistic representation of the network and an interoperating enterprise architecture that leverages the value of network data to a more beneficial knowledge representation (KR) of the smart grid. The demonstration of this research using full National Grid operational models is reported on in this thesis in Chapter 5.

Due to the increasing fraction of renewable energy generators and the loss of system inertia as large coal-fired rotating machines are decommissioned, the issue of frequency stabilization has risen in importance. Voltage stabilization has also become more critical as peaks in generation from wind farms often occur at night when loads are at their minimum. For this reason, as the grid becomes increasingly decarbonised, there is a greater need to 'buffer' electrical energy in some form of storage, over a range of capacities depending on the use case. In addition, the range of sizes and complexity of generation technologies is increasing, requiring smart grids to manage aggregated injections of a few kilowatts from domestic generators up to 1.8GW from generators within the new nuclear fleet. Taking the even wider view of integrated national energy planning, the role of energy storage can be linked directly to energy security. This adds a further dimension to the traditional process of instantaneous balancing of generation with load.

The CIM has been recognized as being at the core of smart grid interoperability standards and so plays a central role in facilitating the management of energy. It is a set of extensible and scalable open standards defining semantic models for power, market and asset system components. As an extensible standard its scope can be grown to meet the needs of smart grid operation. While the modeling of energy storage is seen as an essential requirement for smart grid rollout, current versions of the CIM have barely addressed this. To meet this immediate and important requirement within the

electricity sector a new extension to IEC 61970-301 within a contemporary release of the CIM [26] was created and is reported on within this thesis.

1.3 Principal Research Contributions

There are a number of contributions to the development and understanding of power utility interoperability that have been made by the work described in this thesis. A detailed analysis of the meaning of interoperability and how it applies to leveraging the value of data to create more meaningful representations of network reality that assist in supporting business intelligence and ontology has been made. This thesis reports on research efforts made from within National Grid that were therefore directed towards actual power utility use cases and requirements for information integration and modelling. In view of this, the research narrative begins with a proposal for an information management framework to be adopted by National Grid as a basis for implementing interoperable power system applications (PSAs) exchanging files in a form compliant with IEC CIM specifications - see (1) below. This contribution has been adopted as part of current management efforts to redesign National Grid operational information management and leverage available data into an Enterprise Data Model at a higher level. A ten-step CIM implementation plan was also created in response to a management request following the above contribution.

A contribution was made to a collaborative project demonstrating the operation of a trusted cloud computing infrastructure designed for managing the exchange of multi-party information relating to the operational and planning requirements of the GB System Operator and TSO. It addresses the increasing frequency of data exchanges and network studies that are expected under the new National Grid risk-constrained, cost-optimised operating paradigm – see (2) below.

For the first time in CIM-related publications a relationship was drawn between the abstractions of real networks to the metamodel level occupied by the CIM against the Object Management Group (OMG) four-layer hierarchy. This contribution serves as a valuable framework of understanding for the role of the CIM and where it fits in the development of end-to-end interoperability – see (3) below.

A novel methodology for managing CIM metadata models within a model repository was developed and demonstrated to National Grid. It maintains knowledge representations provided by different PSA data models in a way that addresses the challenge of heterogeneous identities applied to common power system resources. This approach provides foundations for the core of a Network Model Management System (NMMS) as well as a knowledge resource to improve the quality of utility Business Intelligence applications - see (4), below.

The IEC CIM standards are developed and presented as a UML class diagram. Utilising the principles of extensibility and class re-use, a UML model for integrating information about energy storage systems was designed in anticipation of the need to consider not only supply and demand per se but also energy storage within future smart grid operational scenarios – see (5) below. After presentation of this work at a CIM Users Group summit attended by members of IEC Working Groups responsible for international standards development, the extension and the principles behind it were adopted by the US Electric Power Research Institute for inclusion within their remit to develop the CIM for Distributed Energy Resources (DER).

The most significant and original contributions are:

1. An information management framework to support CIM implementation and a SOA at National Grid was developed and presented and adopted by National Grid management. It included a novel ten-step CIM implementation plan.
2. In response to the lack of interoperable infrastructure supporting metamodel exchange between GB power utilities, a contribution was made through collaboration on a novel trusted cloud infrastructure design co-developed with the Oxford University eResearch Centre and Open Grid Systems by providing a viable use case. This was demonstrated to National Grid as a potential solution to the expected increase in model exchange and data management requirements of flexible electricity networks.

3. A novel philosophical basis for utility knowledge engineering was established by integrating existing models of interoperability and metamodelling. This was deemed necessary in order to create the wider framework of understanding required to apply the IEC CIM to challenges both within and between utilities to exploit the benefits of semantic interoperability.

4. A novel methodology for utilising the IEC CIM within a metamodel repository was developed to merge full National Grid metadata models. It was demonstrated using CIM metadata models exported from the EMS and Offline Transmission Analysis tool (OLTA). This design contributes an enhanced management capability over disagreement of resource parameter values composing these essential power system application models. The methodology enables engineers to see the differences between resource parameter values and identify opportunities to harmonise modelled network data in pursuit of 'one version of the truth' if desired. The methodology described also supports the opportunity for an enterprise ontology and advanced business intelligence.

5. Addressing the issue of large-scale renewable energy technology and demand side service integration into the smart grid, the need for management of information controlling the use of EES within the IEC 61970-301 standard was identified. An extension to the CIM canonical architecture was designed comprising a new 'package' of UML classes that re-used existing structures of the standard metamodel to leverage the benefits of code re-use and logically connect into it.

1.4 List of Publications

The work described in this thesis has given rise to a number of refereed publications as follows:

1.4.1 Journal publication

N. B. Hargreaves, S. M. Pantea, G. A. Taylor, "Foundations of a Metamodel Repository for use with the IEC Common Information Model", IEEE Transactions on Power System, (Accepted, June 2013).

1.4.2 Book chapter

N. B. Hargreaves, S. M. Pantea, G. A. Taylor, "The IEC Common Information Model in smart grid interoperability knowledge representation processes" in *Large Scale Renewable Power Generation: Advances in Technologies for Generation, Transmission and Storage*, J. Hossain, A. Mahmud, Eds, Springer. (Submitted, May 2013).

1.4.3 Conference publications

N. Hargreaves, S. Pantea, G. Taylor and M. Irving, "A critical comparison of approaches to resource name management within the IEC common information model," in *Innovative Smart Grid Technologies (ISGT Europe), 2012 3rd IEEE PES International Conference and Exhibition on, 2012*, pp. 1-6.

N. Hargreaves, G. Taylor and A. Carter, "Smart grid interoperability use cases for extending electricity storage modeling within the IEC common information model," in *Universities Power Engineering Conference (UPEC), 2012 47th International, 2012*, pp. 1-6.

N. Hargreaves, G. Taylor and A. Carter, "Information standards to support application and enterprise interoperability for the smart grid," in *Power and Energy Society General Meeting, 2012 IEEE, 2012*, pp. 1-6.

D. Wallom, M. Turilli, G. Taylor, N. Hargreaves, A. Martin, A. Raun and A. McMoran, "myTrustedCloud: Trusted cloud infrastructure for security-critical

computation and data management," in *Cloud Computing Technology and Science (CloudCom), 2011 IEEE Third International Conference on*, 2011, pp. 247-254.

N. Hargreaves, G. Taylor, A. Carter and A. McMorran, "Developing emerging standards for power system data exchange to enable interoperable and scalable operational modelling and analysis," *Universities' Power Engineering Conference (UPEC), Proceedings of 2011 46th International*, pp. 1-5, 2011.

1.4.4 Invited presentation

IEEE PES General Meeting, 21-25 July 2013, Vancouver, British Columbia, Canada.

Panel Session "The use of CIM Standards in Smart Grid Applications"

G. A. Taylor, N. Hargreaves, P. Ashton, M.E. Bradley, A. Carter, "Potential integration of Phasor Measurement Units and Wide Area Monitoring Systems based upon National Grid Enterprise Level CIM".

1.5 Thesis outline

This thesis has been divided into 7 chapters:

Chapter 1 provides an outline of the context and research rationale for addressing a number of smart grid information integration and interoperability problems. In addition the research contributions described in this thesis are summarized with their associated publications.

Chapter 2 frames the IEC CIM in the context of the smart grid, interoperability and information integration. These terms are discussed in detail as well as the wider standards architecture relating to smart grid interoperability. A survey and analysis of relevant literature is presented to establish the existing understanding and context in which the CIM is applied as a foundation for the research contributions described in the following Chapters.

Chapter 3 discusses the implementation of the CIM within a process of information integration at National Grid. A new, modelled information management framework designed by the author for National Grid is presented following the principles of Enterprise Information Management (EIM). This is followed by conceptual designs for SOA.

Chapter 4 extends the foundations of the National Grid Market Operations SOA raised in Chapter 3, to describe the demonstration of a novel trusted cloud infrastructure that could be deployed to support information exchange and interoperability between different stakeholders within and external to National Grid.

Chapter 5 extends the work described in Chapter 4 in the direction of a key challenge within interoperability, that of identity management of common power system resources within multiple knowledge representations of the smart grid. The demonstration of a novel solution underpinning the design of a metamodel repository is described. The repository methodology also shows how it can enhance enterprise situational awareness and support business intelligence by building a foundational enterprise ontology.

Chapter 6 discusses the need for an integrated approach to decarbonisation and energy security management and the application of electrical energy storage in supporting the integration of large-scale renewable energy technologies. Demonstrating the extensibility of the CIM, a novel extension to the IEC 61970-301 standard is presented for energy storage metamodeling.

Chapter 7 summarises the principal conclusions of the research work presented in this thesis, highlighting its main achievements, contributions and potentials for further developments.

CHAPTER 2

THE IEC CIM IN CONTEXT

2.1 Introduction

This chapter aims to place the IEC CIM in context as part of a core group of standards underpinning smart grid interoperability. What is meant by *smart grid* and *interoperability* will be addressed first in order to establish these as essential terms of reference before proceeding to discuss the CIM and its role in supporting interoperability and information integration.

2.2 The smart grid concept

The smart grid has been described as a *cyber-physical* entity reflecting the emergence of an increasing interdependence between the ‘hard’ and ‘soft’ infrastructure it is made up of [27,28]. A striking contrast between electricity networks of the past and present, is the rapid rise of data availability from a wider range of sensing technologies which, notwithstanding the advancements in network and generation processes, is driving the rapid reformation of the modern electricity industry. Tighter integration with market, service and consumer domains is being enabled but extension of the scope of the smart grid to other energy prime movers such as gas and possibly water is conceivable in future. Management of the smart grid is challenged by the increase in data volume and the requirement for interoperability. For example, some 50 million electricity and gas smart meters are to be installed in the UK alone in the next 7 years [29]. That the reflexive nature of the smart grid requires a guiding intelligence provided by information and communications technology (ICT) systems is undisputed [30].

Electricity transmission networks are already smart but with the addition of VERs, DERs and AMIs a holistic approach to conceptualisation of the smart grid is necessary covering not only the domain of transmission but also distribution, storage, generation, markets, service providers and customers [31]. To establish the role and importance of the CIM and associated standards in the information networks that overlay the physical electricity networks it is necessary to frame them within the smart grid concept. In

practical terms, this understanding is also essential to making the business cases necessary to justify investment in the changes to power utility information architecture and infrastructure. In responding to the greater flexibility and responsiveness in smart grid capabilities these business cases acknowledge the need to manage and leverage the value of the increasing amounts of available data that will not be possible without an established standards framework relating to generally agreed conceptual models of what the emerging smart grid actually is.

The origins of the smart grid concept have been described in [32] with the US Department of Energy (DoE) initiating research and development [33], with outcomes such as the Electric Power Research Institute (EPRI) *Intelligrid* programme [34]. The strategic prerogatives for sustainable energy and security, functionality and management of electricity networks have formed the basis of smart grid development initiatives around the world [35,36,37,38,39]. In [40] the European Commission (EC) views the smart grid with an essential role in achieving the '20/20/20 targets' set for the EU countries. EC mandate M/490 is the umbrella directive for smart grid development coordination and has driven the formation of the Joint Working Group (JWG), also known as the 'Smart Grids Coordination Group' (SG-CG), comprising CEN, CENELEC and ETSI standards development organisations. Previous EU mandates already existed for the development of open smart metering standards (M/441) and electric vehicle charging standards (M/468).

These initiatives lead us to a broad functional definition of a smart grid having the following characteristics:

- Maintains and enhances security of supply.
- Facilitates connection to low carbon generating plant.
- Enables innovative demand-side technologies and strategies.
- Facilitates further consumer choice over energy management by providing tariff-based choices.
- Features a holistic communications system providing greater clarity of the grid state and allows it to operate in a (reflexive) way coherent with its decarbonisation priorities.
- Allows optimisation of cost and carbon impacts upon networks.

Given its broad scope, which effects millions of stakeholders and draws upon massive investment to realise, it is imperative that the conceptual models drawn from different viewpoints of the smart grid are widely accepted and established as reference architectural standards. Reed *et al.* highlight this point by indicating while different players define the smart grid according to their particular perspectives, it will be difficult to arrive at consensus on gaps in standards and technologies without a standard definition [41]. Two models are continuing to converge and form the dominant standard for high-level smart grid conceptual reference architectures however. These are the NIST 'Conceptual Architectural Framework' [42] and the EU Smart Grid Coordination Group's (SG-CG) 'Smart Grid Reference Architecture' [43]. The NIST framework is based upon seven interoperating domains comprising, "Bulk Generation, Transmission, Distribution, Customer, Operations, Markets and Service Provider". The SG-CG architecture, or SGAM (Smart Grid Architecture Model), generally corresponds to the NIST Model but has extended it with the addition of an eighth domain for "Distributed Energy Resources". Its three-dimensional presentation reflects the flexibility of the smart grid in a range of manifestations from centralised to non-centralised as well as accommodating forward looking local area energy systems such as micro-grids.

2.3 Interoperability and Service Oriented Architecture

Rather like the Internet, the smart grid is a coupled 'system of systems' requiring strong coordination across the participating domains and their sub-systems. The NIST and SG-CG reference architectural models reflect the need for a disparate number of technologies and functional domains to interoperate effectively. Different definitions of *interoperability* exist but in the context of the smart grid it should incorporate the following characteristics:

- A capability between two or more systems, networks, organisations, applications, components, processes or devices to exchange meaningful information that is readily usable.
- A shared understanding of the exchanged information.

- An expectation of the request to exchange such information that is agreed upon.
- A requisite quality of service in terms of security, reliability and fidelity even though the information may be exchanged over different systems, infrastructures or regions.

The GridWise[®] Architecture Council (GWAC) was formed by the US DoE to lead on promotion of interoperability between the entities in the USA that make up the smart grid in recognition of interoperability as a key enabler of the smart grid as a whole. The GWAC “Stack” methodology [44] has now been adopted by NIST and the SG-CG as an interoperability reference framework between the different domains and actors in their models. By being integrated into the dominant conceptual reference architectures this interoperability framework has become fundamental to our conceptualisation of smart grid interoperability. Although not standardised in itself and modifiable to suit the context, it remains an important reference to what we mean by interoperability. The GridWise vision acknowledges the premise that ICT will revolutionise the planning and operation of the power grid, just as it has in other business domains (such as healthcare, telecoms and finance), and that ICT will form the *nervous system* that integrates its technologies.

The ‘GWAC Stack’ comprises eight levels in its conceptualisation of *end-to-end* (E2E) interoperability, ranging from ‘Basic Connectivity’ at the physical level of component interoperability to ‘Economic/Regulatory Policy’ at the organisational level where it incorporates Business Objectives and Procedures (Fig.1). “End-to-end” interoperability is a term used to describe effective interoperability across all levels between these extremities. It is within the *Informational* layers of ‘Business Context’ and ‘Semantic Understanding’ in the middle of the Stack that the IEC Common Information Model can be deployed. These layers form the bridge that transfers meaning in the form of *syntactic conformity*, *semantic understanding*, and *context* from the signals arising from the lower technical layers, mainly concerned with message syntax and protocols, upwards to the Business Objectives and Policy layers at the head of the Stack. This is of critical importance as it is necessary for the business components involved at each level to share

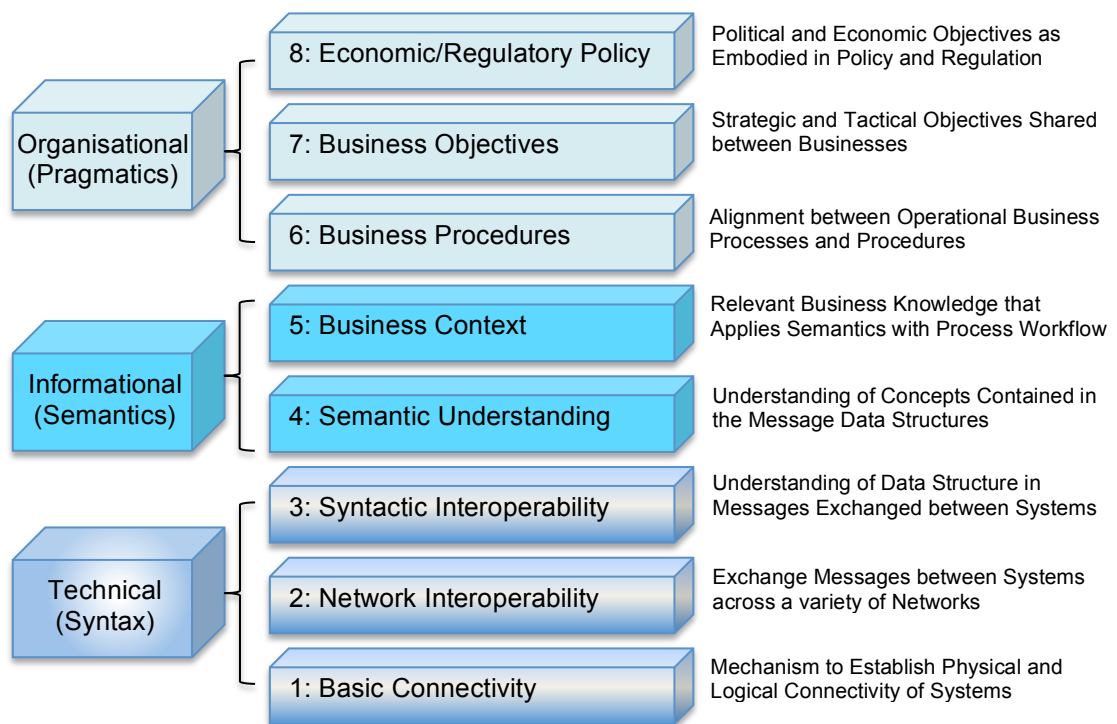

Fig. 1. GridWise[®] Interoperability Context-Setting Framework (“GWAC Stack”).

information between themselves and others (as in an enterprise-to-enterprise scope) in order to achieve their tactical and strategic objectives. This can only happen if they are working in a sympathetic and federated manner across their boundaries of jurisdiction with full understanding of message content and close conceptual conformance with actual reality.

Any ‘standard approach’ to interoperability must be scalable and be able to recognise agreements established at component interfaces as well as boundaries of jurisdiction. Scaling-up will inevitably encounter hierarchical, organisational and structural challenges, such as when different business domains attempt to interoperate or integrate with a single enterprise data model (EDM) because of their use of different models. In the case of the smart grid in its wider manifestation of system operation and inter-system operation [45], it will also be necessary to interoperate across enterprise boundaries, such as between a TSO and a DNO, with the need arising for infrastructure protecting security, privacy and service level agreements. Nevertheless, from a resilience point of view, the smart grid is also composed of small and in some cases autonomous operations, such as with

DER and protection systems management, which could reduce the scope and scale challenge. Despite the scalability of the smart grid therefore, many of the processes to establish interoperability will be cross-cutting issues, effective at all levels of scale. Ambrosio and Widergren in [46], discuss many examples of cross-cutting issues including resource identification, time synchronisation, security and privacy which are important to establish interoperability at any level of the smart grid and form a foundational thread in the research narrative of this thesis.

Data model exchange within the context of utility information integration is a key part of the interoperable *glue* between corporate objectives in terms of business positioning and PSA solutions that facilitate the enterprise orientating as intended. It is likely therefore that the *form* of the information architecture will *inform* the function of the enterprise and raise the question of whether it is fit for purpose. Such an appraisal informs the need for enterprise architecture to be coherent with corporate objectives and regulatory constraints. Connecting this concept to the ‘solutions level’ (levels 1 to 4 in the GWAC Stack) of the enterprise, especially in times of rapid market change, places greater emphasis upon information integration and the removal of legacy system obstacles such as data silos and manual trans-literation interfaces between bespoke systems.

Tolk has addressed these concerns in his *Levels of Conceptual Interoperability Model* (LCIM), and observed that the “*conceptual ideas of the enterprise and the implementation details of the systems*” often do not connect [47]. This may be due to inappropriate architectural design but also that the interoperability of legacy systems within a complex multi-system architecture cannot always be *decidable* in advance. Examples of undecidable problems (there is no algorithmic solution but a result relies upon a good heuristic) include questions such as, “Is the specification complete or minimal?” “Is the order of two modelled actions independent or requiring orchestration?” Tolk proposed that the utility of enterprise architecture to fully support interoperability, develops through three broad stages (terms originally defined by Page *et al* [48]).

- Integratability – concerns physical and technical connectivity of systems, including hardware, networks, firmware and protocols
- Interoperability – concerns software and firmware to support information exchange through the use of common semantic models
- Composability – concerns the alignment of the use of models as conceptual abstractions of reality for given business intentions

The LCIM (Fig. 2) was created to present these related issues in a consistent framework that exposed six levels of interoperability, ranging from 'Technical' to 'Conceptual' Interoperability, rising from concerns of infrastructure communication to the appropriateness of the interoperability composition in meeting the objectives it was conceived for. At the centre of this hierarchy we find 'Semantic Interoperability' linking the 'Syntactic' level to the 'Pragmatic' interoperability level. The Syntactic level deals with protocol challenges while the Pragmatic level deals challenges of interpreting message patterns. The LCIM was adapted to and informed the creation of the GWAC Stack framework, underpinning the centrality of the IEC CIM and the importance of ICT interoperability to smart grid control and integrity as it infuses all levels of the energy domain.

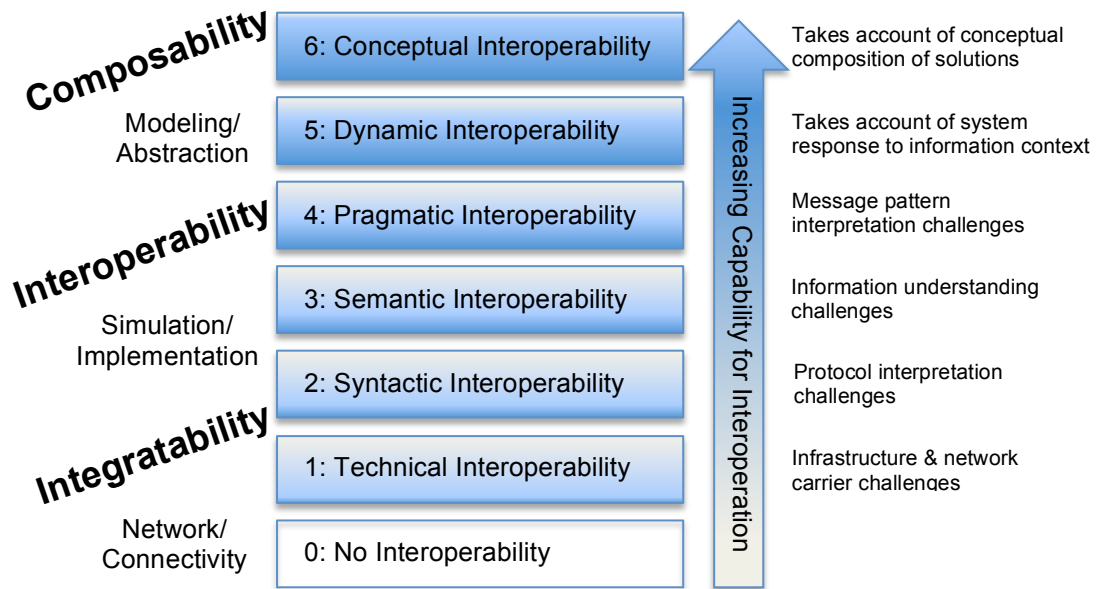

Fig. 2. The Level of Conceptual Interoperability Model (LCIM).

System architectures are developed to fill the gaps in enterprise capabilities. The architecture should map to the detail of the functional requirements but in a rapidly developing environment like the smart grid where there is added pressure to evolve the enterprise alongside multiple independent stakeholder interventions, the risk of conceptual interoperability intentions misaligning with actual interoperability outcomes could be higher than average. Tolk identifies some major practical challenges to maintaining interoperability in alignment with the overall conceptual design:

- Interoperability satisfies the needs of a limited number of stakeholders due to independent interventions and becomes unaligned with enterprise interoperability concepts.
- The implementation suffers from not being maintained in step with the latest developments.
- The diversity of smart grid developers, regulators, implementers and other actors are not as aligned as desirable.
- Interventions of one kind have negative secondary impacts on other systems.

These are familiar concerns to system integrators within electricity utilities involved in developing greater interoperability at PSA and enterprise levels. This author contends that they are especially likely to develop in situations without hierarchical supervision and coordination of stakeholder interventions and where insufficient attention is paid to cross-cutting challenges. The fourth issue in the list above is particularly relevant to the topic of resource identification. Where there are multiple independent actors who share a common domain, the opportunity for the same network entity or resource (such as a power transformer, substation, circuit breaker or process) to be described and identified differently is very real. Within a single actors' model of the network, this may not give rise to ambiguity but when models are exchange and shared with other actors the issue of resource identity can cause conflicts in semantic understanding and disrupt interoperability. It is a vexing challenge to the application of a common information model across multiple PSAs and business domains and is addressed in greater detail in Chapter 5.

Taking a systems engineering approach at the PSA-to-PSA level, the use of metadata is important in assessing the possibility for, and then supporting interoperability. Between two PSAs with a common operational intention there would be need for three sets of metadata, one set describing each PSA and the third describing the design of the desired functionality. It is then possible for an assessment of composable interoperation between heterogeneous PSAs to be made, subject to the decidability of the interoperability outcome as previously discussed. Ralyté *et al* say that due to the complexity of the interoperability challenge across multiple domains, including business and technology, it is not possible to find a solution to the problem captured by a single method. They discuss a Situational Method Engineering (SME) approach to interoperability problems that involves modularised reusable *method chunks* to compose situation-specific interoperability solutions as they arise [49]. Hug *et al* [50] support this view from an information systems engineering perspective and say even the use of standardised metamodels may reveal the limitations of a 'one-size fits all approach' in future. This could mean that as the use and understanding of

metamodels becomes more widely appreciated we see the need for more situational metamodel engineering (SMME) to underpin process interoperability in the power industry. Such a Model Driven Engineering (MDE) approach would employ the key principles of a standardised method to building the metamodel appropriate to the situation from a number of smaller submodels, or *profiles* (see p26 for more detail about profiles). It may also lead to a general trend towards the use of higher levels of abstraction.

Similarly, this has already started to happen within the power industry through developments involving the IEC CIM as a *domain ontology* [51] (further explanation of the CIM as a domain ontology can be found in Section 2.7, below). For example, in [52], Britton and deVos recognise, “The trouble with a global information model is precisely that *global* is a pretty big area to manage”. They see the value in the CIM moving from an “explicit interface specification role to a design methodology role” and the possibility for it to underpin a service-oriented architecture (SOA). SOA is a software model in which the concept of a *service* is an abstraction of a function used by an application [53]. Services either provide information, or change data from one state to another. It is a function that may be *reusable* within a business process [54]. Once these functional components of the business process have been identified and related to a semantic model, it becomes possible to model them into an efficient structure, such as to emphasise the value of service re-usability, interoperability and open availability of data. In this way modelling can be used to drive better understanding of business processes and further their integration within the enterprise.

SOA can therefore further the scope of interoperability through closer integration of Business Process Management (BPM) to reusable information message exchanges that call for different service operations. Such an approach is summarised by Soley in [55], where he sees BPM design being linked to SOA infrastructure by the “vital bridge” of Model Driven Architecture (MDA). MDA is underpinned by the use of metadata standards to adapt business process models to service requirements in a changing environment such as the smart grid. MDA, itself based on the principles of Model Driven Design (MDD) [56] can also aid in the recovery of design knowledge from existing applications through its use of standards. This approach has been

adopted by McMorran *et al* to develop transformation applications for CIM-structured metadata files to the Siemens Power System Simulation (PSS/E) standard for model exchanges supporting PSA-PSA interoperability [57][58].

Another important aspect of SOA is that it opens the way for data to be shared across an enterprise by way of a web service. Web Services Description Language (WSDL) is a commonly supported means of describing the necessary interactions between a service requester and a service provider. It rests as a separate layer upon the data architecture of the enterprise, independent of the code required to implement the service but offering the potential to develop common interfaces for various types of interactions which leverage the value of software assets as well as data resources. As this web-based approach also opens the number of data access points, security becomes a greater consideration to protect the integrity of proprietary data and system functionality.

In this way SOA enables a looser connection to the service provider technology and enhances the scope to offer vendor-neutral solutions. In [59] Cao *et al* also propose the use of the CIM within an SOA to address information-islanding problems encountered within Enterprise Application Integration (EAI) challenges. Khare *et al* [60] develop this theme, describing the use of an Enterprise Service Bus (ESB) within the SOA to “simplify and manage interconnectedness”. They also describe the use of metadata within ‘design patterns’ to support interoperability problem description and contribute to process design for common modelling practices such as CIM extension, profiling and model validation.

Announcement and discovery of metadata underpins the ability to access and leverage the available data and services in an interoperable infrastructure. Rohjans *et al* [61] propose a SOA based on the Open Platform for Communications (OPC) Unified Architecture (UA) [62], a standardised server-client architecture specification (see IEC 62451) that embraces security, platform independence and information models to support interoperability. Their approach brings together a general automation industry SOA solution (OPC UA) for access to real time and historical data and events, to run semantic web services that interact with the Platform Independent Model (PIM) provided by the CIM. Service descriptions are

provided by metadata annotations derived from a Web Service Modeling Language (WSML) ontology.

Neumann and Nielsen in [63] refer to *profiles*, or context-constrained sets of CIM classes that make up the Common Power System Model (CPSM) and the Common Distribution Power System Model (CDPSM) [64,65]. These ‘sub-models’ of the CIM are accredited standards in themselves and like other available profiles address ‘common integration patterns’ within interoperability challenges and therefore resemble the approach to situational interoperability advocated above. The earliest releases of the CIM [66] were designed to refer to control centre applications and serve to support their interoperability [67,68]. As packages of classes are added to it that refer to the operation of more diverse aspects of the smart grid, it is conceivable that ‘method chunks’ of the reference metamodel could be applied to interoperability challenges yet to come. Effort is also being made on the harmonisation of adjacent standards, such as IEC 61970 with IEC 61850 [69] in the interest of extending interoperability across different conceptual metamodels. The power of standards-based metadata at all levels of interoperability described in the LCIM then becomes evident, subject to the limitations of one-size-fits-all, in supporting composable solutions appropriate to the capability-requirement gaps within the enterprise architecture.

Metadata plays a key role in the absence of a fully self-organising system of systems, in which operational systems have built-in evidence of their components’ functionality, necessary for their level of interoperability to be evident to the other interoperating parties. We may currently approach this level of *self-evidence* or *self-description* by exploiting the built-in rules in RDF and XML notation in ‘knowledge representation’ [70,71] but these form only the ‘skin’ of interactions between our enterprise component systems at present. As knowledge depends on how information is modelled, deeper evidence of the capacity for interoperability and classification of the challenge could be evinced from meaning encoded into the structure of the metadata, thus raising the attraction of standard forms of metadata as in the cases of the IEC Common Information Model standards. The intention of building this kind of ‘structural intelligence’ into our metadata models would be to make it possible to see some degree of self-organisation at the interface between

interoperating entities. This degree of interoperability could go beyond the achievement of 'self-description' and 'self-discovery', which is currently an aim for advanced distribution automation systems [72].

2.4 Use Cases

Smart grid interoperability depends on standards used by the diverse range of equipment and processes it is composed of. Standards also ensure against premature obsolescence and support security implementation within the technologies they apply to. Utility PSA and equipment interface requirements have driven the need for a reference ICT standards architecture that can be mapped to smart grid reference architectures to satisfy actor interaction requirements. The linkages between the standards architecture and smart grid conceptual architecture are *use cases*. These describe the series of events involving an actor and a technology or process, necessary to execute the intended smart grid capabilities and functions. In this sense, by forming the essential connection between a subject and its objective, the use case reflects the notion of the 'subject-predicate-object' *triple* familiar within RDF notation [73]. The scope for standards extension, modification or for new standards to be included in the reference architecture widens as the use cases for smart grid information and communications integration increase [74].

Use cases vary in the detail of their specification according to NIST by being either "prescriptive" or "descriptive" [42]. The latter omits the specification for the implementation of the use case but describes the actor and functional requirements of the intended goal. Rigorous definition of use cases is therefore advisable to avoid confusion not only over the objective of an intended functionality but also to limit duplication of standards development effort. The reference for defining smart grid use cases according to the EPRI IntelliGrid methodology is given in IEC Publicly Available Specification (PAS) 62559 [75]. Its application process under M/490 is given in [76]. Smart Grid use case repositories are being developed in the EU and the USA with one of the most mature managed by EPRI [77] (see also the NIST Interoperability Knowledge Base [78]).

2.5 Standards architecture

In [79] NIST identified 75 existing standards and 15 high-priority gaps in support of smart grid interoperability, in addition to cyber-security issues, as a starting point for standards development and harmonisation by standards setting (SSO) and development organisations (SDO). Sixteen Priority Action Programs (PAPs) have been initiated by NIST to address areas in which standards need revision or development to complete the standards framework according to their smart grid vision. The IEC Standardization Management Board of Technical Committee (TC) 57 identified over 100 standards and standard parts in a strategic review of power system information exchange [80]. Both of these studies concluded however, that only a small number of standards lie at the core of smart grid interoperability and they can be organised into a corresponding layered reference architecture described in IEC/TR 62357. This reference SOA shows how these standards relate to each other, require harmonisation and presents the gaps where further standards development work is required. In general all standards setting and development organisations advocate a collaborative approach to the development of open standards for the smart grid, with the re-use of existing standards as far as possible. It is reproduced in Fig 3. according to [81]. There are three high-level parts to the architecture as indicated by the shading in Fig. 3. The upper part covers standards required for integration of business processes and control centre applications. The lower part covers standards related to field device connectivity. The cross-cutting issues relating to cyber-security are addressed by the standards on the left hand side.

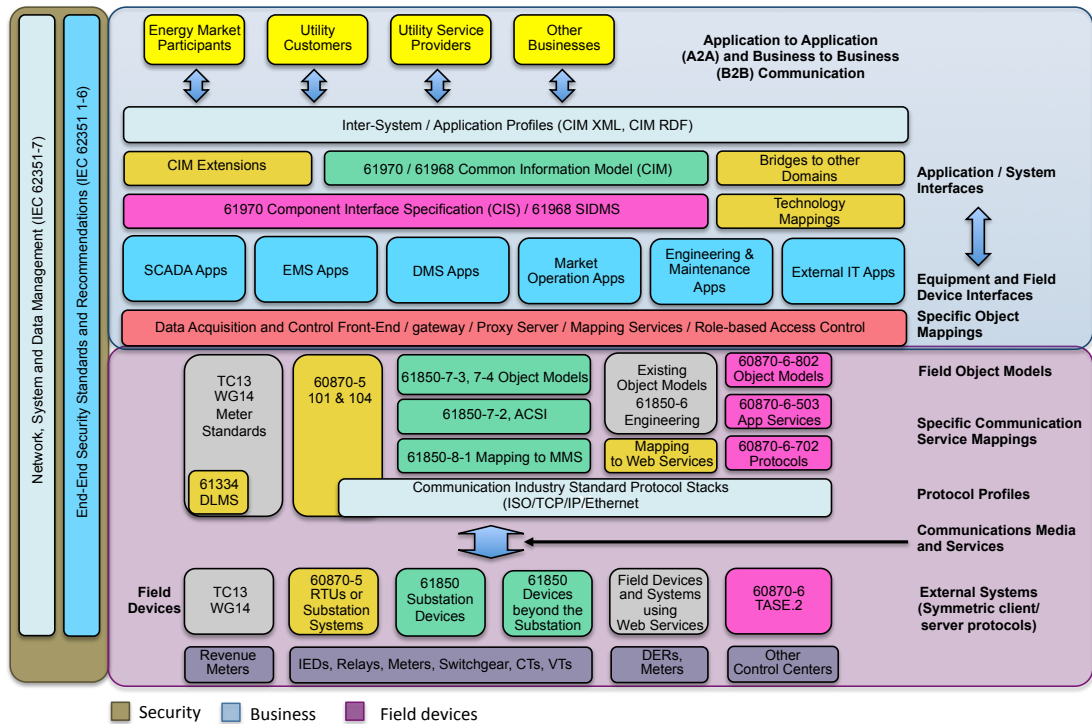

Fig. 3 IEC/TR 62357 Reference Architecture for Power System Information Exchange.

Rohjans *et al* in [82] conduct a global survey of smart grid standardisation studies and confirm that the IEC/TR 62357 standard, also known as the ‘Seamless Integration Architecture’ (SIA), represents a general consensus of what are the core smart grid standards, subject to two additional standards. These are IEC 61400-25 series: Communications and Monitoring for Wind Power Plants [83] and IEC 62056: Companion Specifications for Energy Metering (COSEM) [84]. The evolution of IEC/TR 62357 reflects the broadening scope of TC 57 in step with smart grid use cases from its original charter of “Power System Control and Associated Telecommunications” to “Power System Management and Associated Information Exchange”. Generally this change reflects the shift in emphasis from lower level interconnection protocols to abstract information models in the higher levels of the architecture as the number of business functions needing to interoperate with PSAs has increased with smart grid evolution.

The TC57 architecture generally follows the form of the GWAC Stack layers 1 to 7, as it ascends from standards concerned with communications relating to the connectivity of field devices through to information exchanges to support business processes and enterprise objectives. Due to the wide

range of perspectives upon what is a smart grid from the countries surveyed, maintenance of the SIA as a central reference is a priority to keep abreast of smart grid evolution. Recommended initial work to extend the SIA would include CIM standards for DER and the increasing number of CIM profiles, electric mobility and charging, as well as relevant standards referring to the OPC UA. A survey of an additional number of international standards initiatives is undertaken in a follow-up work [85], which draws similar conclusions to those in [82].

The middle layers of the GWAC Stack are in transition from a Technical to an Organisational focus requiring information interoperability. These 'Informational' focus layers correspond to 'Business Context' and 'Semantic Understanding'. They align with the CIM standards IEC 61970, IEC 61968 in IEC/TR 62357. In IEC/TR 62357-1 [86], a further standard, IEC 62352, is added to the CIM. These standards make up the current specification for the IEC Common Information Model and broadly apply to the functions of EMS application integration, distribution system application integration and energy market system communications integration respectively. Their importance has been described by NIST as central to the foundations of smart grid interoperability [87]. The official designations for the CIM standards are IEC 61970-301 [88], IEC 61968-11 [89] and IEC 62325-301 [90,91]. Recent development of IEC 62325 to suit a European energy market context is ongoing and a finished extension to this standard is expected to be published by the IEC in 2014.

The EU Task Force for Smart Grids, Expert Group 1, have analysed smart grid interoperation from the three perspectives of Transmission, Distribution and Home and have also summarised international standards harmonisation initiatives in [92]. Their standardisation methodology recommends a top-down approach with three levels, taking into account Mandate M/441 to ensure that smart metering is included in wider smart grid application standards. The three levels are as follows:

- 1/ Harmonise smart grid use cases in member states
- 2/ Harmonise smart grid data modelling and description language
- 3/ Harmonise communication protocols

A further significant standards framework in support of a SIA is the Institute for Electrical and Electronic Engineers (IEEE) Smart Grid Interoperability Reference Model (SGIRM) [93], which addresses interaction between the actors within the 7 domains identified in the NIST Conceptual Architecture Framework. Its focus is upon interface architectures and data flow characteristics from three architectural perspectives: communications, power systems and information technology platforms. It provides a scalable model of functional interoperability that can be extended as the scope of the smart grid evolves.

2.6 A critical review of the IEC Common Information Model

In the following Sections of this Chapter key elements of the IEC CIM referring to smart grid interoperability will be reviewed in order to develop the research rationale further in preparation for presentations of research outcomes in Chapters 3, 4, 5 and 6.

The significance of the IEC CIM standards relates to their function as a scalable and extensible semantic model for power systems. An authoritative description of its design and class composition is given in the associated IEC Standards (IEC 61970-301, IEC 61968 and IEC 62325) and it is further described in [94,95]. Misconceptions about the CIM in terms of its use in database design and the 'CIM compliancy' of technology interfaces are addressed in [96]. The structure of the CIM is designed to be flexible. It is object-oriented and presented as a Unified Modelling Language (UML) class model. Flexibility of the model derives from its properties of *extensibility* and *scalability*. Extensibility applies to adding new objects not available within the standard set when they are needed. If these additions are considered of general use and subject to subsequent interoperability testing, they can become inducted into the internationally standardised version [97].

Examples of CIM extension to suit utility use cases are numerous and reflect business case evolution in managing the smart grid through use of MDA. Extensions to the CIM can be categorised for different purposes, such as widening its domain scope for vendor-specific reasons to cope with proprietary features or to accommodate a particular utility project requirement. Documented examples of extension for these reasons include, distribution

network automation at Electricité de France (EDF) [98] substation equipment representation [99] or High Voltage Direct Current (HVDC) modeling [100], to extending its ability to represent dynamic models for contingency analysis [101] and derivation of bus-branch connectivity models for topology processing [102]. Further discussion of reported implementations of the CIM and the business cases driving them will be addressed in section 2.9.

The IEC CIM is also being used as the design basis for a variety of new model-driven applications including state estimation [103], wide area measurement [104], and secondary equipment management [105]. As it is canonical in its design, it is possible to integrate new packages of UML classes with dependency to the Core package as the scope of use cases for information exchanges widens. Nielsen and Neumann give a good overview of the processes associated with CIM extension management in [106]. An important recommendation from consensually accepted definitions of smart grid standards identified in [82] featured extension of the SIA to accommodate DERs. With respect to future smart grid operational requirements this recommendation was responded to as part of the research contribution reported in Chapter 6 of this thesis.

The CIM is also designed to be *scalable*, such that if a subset (or profile) of the standard reference classes are sufficient to model a given use case in a particular context then the rest of the reference metamodel can be ignored. Well-established profiles such as the CPSM and CDPSM have already been mentioned but the tendency to profiling for re-usable functionality within the exchange of network models has become more common. The second edition of the ENTSOE profile version 2.0, which was based upon CIM release 15, is an example of a combination of a bundle of standardised CIM profiles, each referring to specific functionality, including:

- Geographical profile, IEC 61968-13
- Equipment profile, IEC 61970-452
- Diagram layout profile, IEC 61970-453
- State variables profile, IEC 61970-456
- Topology profile, IEC 61970-456
- Dynamics profile, IEC 61970-457

The relationships between CIM UML classes are structured to provide a standardised object-oriented modelling architecture. This enables the CIM as a canonical taxonomy in the form of ‘packages’ of UML class diagrams *referring to* the components of power utility networks with functional definitions and measurement types specified to a high degree of granularity. Wang and Van Ausdall give an overview of how business data semantics are represented in the CIM and propose some rules to clarify the UML modeling concepts used [107]. They describe how a namespace [108] defines the scope of a class name and observe how a CIM class name (and therefore the concept represented by that CIM class) must be unique within the CIM namespace to maintain the integrity of the CIM logical model. This raises the distinction between the CIM as a static logical model, a standard conceptual representation of smart grid components, and the *instantiation* of CIM objects in models created by PSA CIM adaptors to represent their functional data models.

Power system applications refer to the CIM as a reference logic when processing CIM models for export and import. The semantic definitions and logical integrity of the exchanged model depend on the CIM standards but its ‘physical’ integrity or connectivity depends upon a system of object identification provided by RDF. RDF links objects together by means of a triple, defining a subject in relation to an object using a *predicate*. The predicate as a system of address, is used to form the identity description of the object and is created within the CIM adaptor of the PSA when preparing a CIM model for communication with another PSA. An instantiated model of CIM objects must conform to the logic and semantic definitions of the standard CIM reference model but will only use a portion of its set of classes to represent the real network. If each interoperating PSA places its instantiated CIM objects with the same namespace, such as “xmlns:CIM”, then the opportunity for object identity *collisions* [109] will arise when these models are shared. This is because the namespace defines the scope of validity for an object identity just as it does for the semantic descriptions of the object. Identity collisions therefore are a vexing problem currently challenging smart grid PSA interoperability. As part of the research contribution of this thesis, we shall address this issue in greater detail in

Chapter 5 when we discuss the possibility of identity collisions between the same CIM objects instantiated in different PSA CIM RDF XML models.

If we consider a model as “an abstraction of reality according to a certain conceptualisation” [4] then these standardised models, as meta-conceptualisations *representing* PSA data models, support the view of the CIM as a metamodel in accordance with [3,110]. The canonical nature of the CIM in giving rise to a range of sub-models (profiles) that describe specific context-constrained applications enable it to also be described in terms of a ‘model of models’ which concurs with the Object Management Group (OMG) definition of a metamodel [2].

Gruber defines an ontology as a “specification of a representational vocabulary for a shared domain of discourse - definitions of classes, relations, functions and other objects” [6]. In this sense an ontology supports the description of our knowledge about a domain. More specifically, Chandrasekaran *et al* argue it is not the representational vocabulary of the domain that defines the ontology as much as the conceptualisations that the vocabulary is intended to capture [111]. Thus careful analysis of the objects and their relationships within the domain is required to create the vocabulary and conceptualisations necessary for true representation of the domain reality. This proposal is fundamental to the capacity of the CIM within the smart grid domain for knowledge representation and sharing and explains why its development is marked by much debate amongst domain experts and interoperability testing. For, as Uslar *et al* indicate in [112], the strength of the CIM as a domain ontology not only depends on the expertise of the domain experts building it, but also its wider application to link control centre ICT with field-automated devices while further developing the SIA.

Regarding the link between the CIM and field devices, Santodomingo *et al* [113][114] discuss the harmonisation of the CIM with IEC 61850 [115] (substation control language) using an ontology matching approach that required the use of Web Ontology Language (OWL) [116] to represent semantic correspondences between the two standards. Their methodology was based on a top-down application of service descriptions that were used to annotate CIM metadata mentioned in [61]. A layered framework of ontologies was created to bridge the semantic meanings within classes and

attributes and the relationships of these entities, that would not have otherwise aligned directly between the CIM and IEC 61850 ontologies. In this way the harmonisation of these two standards, that were designed from different origins and for different purposes but now are increasingly required to interoperate to develop smart grid functionality, is being established.

In another initiative, linking the CIM to IEC 60870 for high-voltage meter control and management is described [117]. The semantic alignment of these two standards is seen as part of the development of the Spanish smart grid. Mapping of the classes from the IEC 60870 protocol to the CIM was reported as straightforward and described in the sense of aligning one 'service' to another. This sense of model classes representing services is another indication of the way the CIM lends itself to SOA. What's more, with the application of SPARQL Protocol and RDF Query Language (SPARQL) [118] the opportunity to interrogate RDF databases annotated with metadata makes possible the benefits of the Semantic Web paradigm. SPARQL is designed to seek out query matches with RDF triples for data stored in an RDF format such as CIM RDF XML. In this case the use of multiple namespaces, as metadata annotation of the meter data captured in CIM RDF XML, enabled the machine-to-machine (M2M) access required by the query. This methodology presents another example of how a layered architecture builds interoperability between the source of data and an end use. Where as the use of OWL as a layer will focus on the resource description logic, SPARQL will focus on the knowledge representation of the RDF triple.

2.6.1 Knowledge Representation

Knowledge representation (KR) reinforces the possibility that the smart grid could herald our evolution in energy management from the "Age of Information" into the "Age of 'Intelligence'". This vision, shared by the State Grid Corporation of China in their "Framework and Roadmap for Strong and Smart Grids" [119] would bring energy management within the realm of the 'Internet of Things' and be just as dependent on a semantic backbone [120].

The pivotal importance of a semantic model to support understanding within KR is underlined by its central position in the GWAC Stack and therefore interoperability. Whether it is to provide a standard means for

message exchange between PSAs interoperating with heterogeneous perspectives of the smart grid, or a standardised interface specification, the CIM's platform independence and ability to support information integration is strengthened as a domain ontology. In [121] Neumann *et al* recognise that the rapid growth of the CIM gives rise to questions about its scope and how best to apply it to a variety of roles ranging from information management and systems integration to information exchanges and application modelling. It could be viewed as a combination of ontologies made from the packages of UML classes of which it is composed, or as part of a federation of ontologies when considered amongst other smart grid standards as well as OPC and MultiSpeak. Either way, it has a range of applications that depend to a greater or lesser extent on the *richness* of the semantic language to convey the meaning of vocabulary, relationships and conceptualisations.

Quirolgico *et al* [122] assert self-managing systems in a domain comprising disparate applications, devices, components and sub-systems depend on a formal ontology to support knowledge interoperability and reasoning. While they were referring in this case to a purely computer network environment, these are some useful pointers to the evolving role of ICT within the smart grid. Not least the importance of full and formal semantic definitions within the vocabulary of the CIM as well as the capability of the languages used for construction and messaging to convey the intended meaning and knowledge representations within the ontology. This is in the interest of reducing the burden of *a priori* knowledge and reasoning on the part of the participating PSAs. In [123] Tang *et al* make the point that the presence of an ontology not only serves to promote knowledge sharing across different departments but also makes knowledge reuse available when there are changes to domain technologies through innovation. In [124] Sourouni *et al* say ontologies can be employed at different levels of understanding. Examples of these range from contributing to the specification, reliability and reusability of systems, through making data exchange easier up to full functional interoperability of data and function.

Referring to the role of the IEC CIM within the 'Semantic Understanding' layer of the GWAC Stack to support information interoperability, we may perhaps consider the need for richer information transport supporting

intelligent 'knowledge interoperability' in future smart grid systems. The latter will depend on the ability of the encoding language to convey the knowledge and reasoning constructs intended by the semantics and metadata of the ontology. Semantics are supported by the formality of the CIM descriptions and are combined with metadata using the schema definitions carried by the schema language for machine interpretation. The XML schema definition (XSD) is used to specify the structure and contents of an XML file and therefore also serves to validate its contents. OWL is designed to explicitly represent the meanings of terms and their relationships in the vocabularies of ontologies. Thus for purposes requiring a higher degree of M2M knowledge representation it may be necessary to consider as schema language, the use of the more powerful OWL over CIM XML, RDF and RDFS expressions in future.

2.6.2 Information Integration

In the preceding Sections we have discussed the importance of the CIM as a semantic model and the importance of accurate and agreed mapping between it and other standards to establish ontology for the smart grid domain. In this section we shall investigate deeper into the challenges posed to information integration in the alignment of heterogeneous knowledge representations.

In an early paper by Bertino [125] the need for organisations to access data stored in "distributed, heterogeneous, autonomous data repositories" was recognised and some key reasons given as follows:

- organisations evolve over time, introducing different data handling systems that influence the way data are arranged within it;
- the choice of data management systems is dictated by performance which in turn could influence the capability, structure and organisation of the infrastructure over which the data is stored;
- not all data belongs to the organisation using it.

These are generic factors effecting interoperability and true today of the smart grid. In a paper by Abdalla [126], the need for interoperability supported by semantic representation and semantic mapping was recognised in order to transform interchanged data from one form to another. He refers to the semantic as being about “the properties of the included value that affects its interpretation” that become vulnerable to conflicts of expression, units and precision. Expressional conflicts are common in the domain of power systems and occur when the proprietary data models within PSAs will map to the same domain elements using different expressions. Examples of this conflict could occur in the way a multi-winding transformer is modelled, or a substation (see Section 5.7.1 for example), or the difference between a connectivity and a topology model. Units are often particular to a proprietary model and could be measured ‘per-unit’ in respect of a base level known to that PSA, or an absolute value. And precision can also vary, most obviously in terms of the rounding factor applied to decimal places.

A second area of data interchange conflict can be found in terms of the structure of the semantic mapped to a domain element. Perhaps the most common issue in this respect is that of element naming and identity as discussed in Section 2.6. Names and identities can differ both in length and composition and perhaps pose the greater challenge to PSA interoperability since the advent of the IEC CIM has resolved several of the above mentioned semantic expression challenges. Several of the issues described above were encountered by Bogen and Latisko in their description of merging and aligning operational and planning models belonging to the Oncor Electric Delivery Company (ONCOR) and the Electric Reliability Council of Texas (ERCOT) [127]. This paper presents a good example of the challenges of semantic, object name and identity and network topological representation collisions and ambiguities that can occur when two business entities that hitherto worked independently are later required to interoperate. The objective to create a single CIM-based model that is coherent to both RTO and Distribution System Operator (DSO) planning and operational requirements is a common design pattern involving extension of a TSO model to include the finer detail in the extremities of the region’s network, provided by the DSO model. Basing this process on the abstracted

representations of the existing PSA asset, planning and operational data models from each utility, the IEC CIM can help to draw their differing semantic and structural representations together for the overlapping parts of the RTO and DSO models. However semantic and structural alignment of model objects is only a first step towards reconciling instantiated deviations in representation of common objects. A focus of research reported on in Chapter 5 of this thesis addresses this issue of heterogeneous object identities instantiated in CIM metadata models communicated by PSAs.

In a forward-looking paper by Chen and Sibley [128] the use of metamodel repositories for enterprise information integration and the creation of knowledge about the knowledge representations they contain is discussed. In fact the repository is seen as helping align information systems to business strategies in a similar way to that mentioned in Section 2.3 above. The model repository supports the flexibility of an organisation to evolve without being hindered by vendor “lock-in” while allowing the exchange of information across multiple platforms. In the examples cited in Chen and Sibley’s paper it was necessary to establish such interoperability (in the absence of a common information metamodel) at the meta-meta level. However the existence of the IEC CIM provides power utilities with the necessary semantic model at the meta level which is a distinct advantage in terms of the effort and efficiency with which we can now interoperate through a repository because fewer layers of abstraction are required. It also precludes the requirement for a separate data dictionary as the semantic definitions of model elements are included in the class definitions of the standards.

In some cases where information integration requires greater detail than is currently supported by the CIM it is necessary to make proprietary extensions to the model as previously discussed. In a paper by Moseley *et al* [129] utility flexibility to introduce new smart grid system requirements (such as the “Green Button” concept) into the existing information architecture is demonstrated through the adoption of industry standards and the creation of a centralised Network Model Management System (NMMS) at ERCOT. Nevertheless the sharing of data with business systems outside of the current scope of the IEC 62357-1 SIA could require abstraction of metadata

to the level of the metameta model to facilitate interoperability. This would be necessary for example where power system KRs from PSAs contribute to a wider EDM in the process of developing business intelligence.

In terms of model version management it would be necessary to develop a repository *check-in, check-out* system to keep track of model developments across multiple interfaces. Such a procedure would control the access to and provide a historic record of metamodel evolution within a multi-user system. It would also be a convenient method to manage standard metamodel versions employed as reference models as in the case of the CIM. For organisations wishing to establish a sound information service infrastructure, Chen and Sibley give some key recommendations that can be readily adapted to a power utility context. To begin with, the formation of a repository management group with the backing and financial commitment of high management is recommended to carry out the following kinds of responsibilities:

1. "Establish naming conventions". This would apply to resource object naming conventions both for in-house and between utility contexts.
2. "Manage version controls and configuration management". This applies both to proprietary extensions to the CIM as well as managing updates published by the SSO.
3. "Establish standards or guidelines for systems development methodologies". In the context of the power utility these would be based on the design template provided by the CIM.
4. "Define a metamodel for the organisation through an evolutionary process". Again, depending on the context, this would be based on the CIM but may also include other semantically harmonised standards such as IEC 61850 or 60870.
5. "Work with groups in system development processes". There are many examples of these currently in action within power utilities such as National Grid, ranging across online and offline operational systems from the EMS, Energy Balancing System (EBS) and Offline Transmission Analysis system (OLTA) to asset and outage management systems. Cross-cutting issues encountered in the

deployment of the CIM lending themselves to design pattern re-use within different development processes would be handled best this way.

6. “Maintain an up-to-date business model by working closely with business managers”. This would tie-in to the development of SOA interfacing business processes with MDA and be a natural requirement of the utility to meet the changing needs imposed by smart grid and regulatory developments.

The need to exchange different data formats, interoperate between systems with heterogeneous knowledge representations and enable flexible engineering of information architecture as business needs and processes evolve over time is a common pattern in information-rich industries. Other examples of repository usage in dispersed, complex data-heavy contexts are cited in financial, marine and space industries. In [130] Bennett describes the process of creating a business conceptual model of semantics for enterprise data management of financial processes and instruments. As even small investment firms may have fifty or more systems using their own data formats, the development of a semantic repository in OWL was driven by the requirement to exchange messages in a standardised way in an attempt to reduce the expensive and error-prone manual re-keying of information.

In [131] Rueda *et al* describe the need for semantic interoperability in the field of marine research. Recognising the solving of semantic and conceptual heterogeneity requires the categorisation of relationships and their expression, or transformation into a homogenous format, they propose the design of a *repository-based ontology registry* that can be interrogated using semantic web techniques already discussed. This process follows closely the one already carried out in the smart grid domain to build the CIM and is addressing the important step of integrating information describing the same or similar concept from diverse sources. In a space industry context, Feirreira *et al* [132] confirm that the use of metadata supports better representation of system components and computational processes. They also recommend the use of a metadata repository in all development phases within an

information system, thereby requiring it to support version management as well.

2.6.3 Enterprise Information Management and business cases

According to Gartner, [133] “Enterprise Information Management is an organizational commitment to structure, secure and improve the accuracy and integrity of information assets, to solve semantic inconsistencies across all boundaries, and support the technical, operational and business objectives within the organization’s enterprise architecture strategy.” It involves the engagement and coordination of people, processes and technology in pursuit of the “single version of the truth” paradigm. The integration of structured and semantically rich information reaches beyond the scope of syntactic integration which has typically been achieved within techniques like EAI [134]. EIM is aimed at providing a basis for the handling of increasingly complex information structures, the need for compliance to the necessary level of data quality in a timely manner and the flexibility and agility of the information system to accept change while providing a competitive edge in the market place.

In this section a survey is made of some of the literature reporting on CIM deployment within EIM, addressing the need for data-to-data, M2M and Enterprise-to-Enterprise information integration and interoperability. The importance of the business case in support of achieving business objectives through EIM is reflected in the latter’s position at the top of the GWAC Stack, subordinate only to economic and regulatory pressures. In respect of this and the financial investment required, an analysis of business cases for implementing business objectives and changes to utility ICT architecture and infrastructure is made after the survey.

In [135] Arnold and Hajagos describe their experience of using the CIM to interoperate data models produced by multi-vendor PSAs to facilitate real-time stability monitoring across transmission and distribution networks operated by Long Island Power Authority (LIPA). At the heart of this project the CIM was used in exchange of EMS and SCADA real-time representations of the network with an operational data management system (ODMS) for voltage stability assessments under a range of on-line and off-

line operational scenarios. In a similar scenario to that referred to in [127] between a Local Control Centre and a Regional Transmission System Operator (RTO), Margelejo *et al* describe the alignment and exchange of the NSTAR on-line operational EMS data model with the ISO-NE EMS model using the CIM [136]. The NSTAR EMS model is initially assembled in a NMMS that allows for updates from the equivalents of neighbouring networks to be integrated into the internal NSTAR EMS model and for the NSTAR model to be published in CIM XML for use externally by the ISO-NE EMS. Motivation for this work was to achieve increased situational awareness supporting network security as well as ease of model maintenance. The persistence of unique model object identities with incremental model updates was reported as an issue within the NMMS. However the concept of a common network repository aligning the NSTAR operational network model externally with the RTO and internally with other NSTAR PSAs was recognised as a business case solution for both planning and operational use cases.

In [137] Wuergler and Vanhemelryck describe the integration of the Distribution Management System (DMS) and asset management system models with the Graphical Information System (GIS) model at the Sibelga electricity and gas distribution utility. The aim of the project was to improve overall data quality and consistency and avoid data duplication. As the GIS served as the central data repository serving network planning and simulation functions in other PSAs, support for different data representations was necessary. Interfaces relied upon the CIM to provide semantic transformations into a common format that interconnected to the participating PSAs over SOA. Manual intervention was necessary to align common model object mRIDs as these were instantiated differently within the each PSA. This was carried out by tracing the containment hierarchy of CIM objects but required continuous update to maintain model synchronisation across the participating PSAs.

Service Oriented Architecture is recognised as a key component within a company-wide approach to standards-based data modelling in [138]. This paper argues that data integration to improve its quality and availability are of highest importance to the management of LIPA's transmission and

distribution operations. With the high value of investment in assets and aging infrastructure the business case for optimised management of assets, which required data to be available from a number of disparate sources, drove the consolidation and integration of data to support new asset management concepts. In order to address vulnerabilities to changes in vendor-supported data services a solution to low-cost and efficient “switching” of applications and service providers without harming the integrity of existing and historic data and systems was sought. A company-wide, top-down strategy was implemented across tools, processes and infrastructure for data modelling and naming to meet bottom-up integration efforts in a consistent manner. Design templates for a model driven methodology and resolution of semantic inconsistencies were delivered using the CIM and other industry standards in consultation with Subject Matter Experts (SMEs). Notably these efforts created a utility-controlled vocabulary to model semantics relevant to LIPA based on the principle of ontology.

In [139] the SOA of the Shanghai Municipal Electric Power Company is presented. The objective of Enterprise Application Integration (EAI) drove the use of SOA, and the IEC CIM was employed to facilitate data translation into a common format at the interfaces of the Production Management System, Customer Information System and Enterprise Resource Planning systems. The outcome of this effort to seamlessly integrate PSAs was reported to be improvement of customer service and higher operational efficiency as well as support the automation of business processes.

Changes to the nature of the electricity market motivated California Independent System Operator Corporation (CAISO) to address EAI through the implementation of CIM-based information integration and SOA [140]. Several new multi-vendor PSAs contributing to the Market Management System (MMS) and the EMS were required to interoperate, prompting CAISO to extend IEC 61970 and 61968 in some parts to model transformations of data from legacy systems [141]. As in the above mentioned examples, manual intervention was required to compare and validate the transformation of legacy data models into CIM-based data models before they were loaded into target systems. The CIM was extended to managed version control by additional metadata annotation of the models using “CurrentVersion” and

“PreviousVersion” classes. Any class and attribute extensions created by CAISO were contained within a CAISO XML namespace which distinguished them from the standard set and was defined as ‘optional’ in model exchanges. Governance of this market replacement programme by an authorised group was considered essential to improving coordination and control and reducing the expense of project rework and production problems.

Wang and Chiu in [142] describe the SOA developed for the US RTO PJM to integrate information from different PSAs in support of a model-driven MMS. The SOA design uses an ESB as an integration technology and is based on a Council on Large Electric Systems (CIGRE) standard for Very Large Power Grid Operators (VLPGO). Data is integrated between 12 participating systems that include the EMS and the MMS as well as a ‘Common Source Modeler’ that provides these PSAs with standardised and consistent CIM-based network and commercial models. They report the most important step in building a SOA is to build a common data model comprised of the different network and service representations created within each participating PSA. The CIM, with some PJM proprietary extensions was used as a basis for building the master model which laid the foundations for middleware data transfers between ‘Business Service Components’ with XML Schema Definition (XSD) and WSDL message definitions. Their experience of successfully developing a CIM based SOA is summarised, highlighting the importance of governance and collaboration between SMEs, implementation processes and the use of standards and technologies.

The business cases for implementing standard CIM-based information exchanges between the asset data source systems, the GIS and the DMS are discussed in [143]. These include the synchronisation of source PSA network representations with operational systems to facilitate better control and efficiency in carrying out distribution utility functions. In an example use case, describing the moving of a distribution line, the issue of generation and persistence of universally unique identifiers (UUIDs) was raised as a key issue affecting successful interoperability between multi-vendor systems. The importance of enforcing a standard schema for the composition of UUIDs was also noted in order for a PSA to consistently assign the same ID to the same device every time it was included in the exported metadata model.

In [144] Illich *et al* describe the business cases supporting the update of an operational, planning and asset management information architecture at Powerlink Queensland a RTO on the eastern seaboard of Australia. These include improved data quality, reduction in data maintenance and easier migration of PSAs once industry standard APIs have been established. The objective to synchronise operational and planning models with three Powerlink customers by creating a CIM-based transmission network model repository is described. A key motivation for this project was to “rationalize the landscape of existing applications and remove data duplication” with the repository serving as a central resource for other PSAs. It will also serve the update of the Powerlink EMS by synchronising the SCADA measurement points and updating the connectivity network model. Temporal management of model versions will include annotation of objects with temporal metadata to indicate their birth and death dates as an extension of the CIM.

In [145] Lambert reports on CIM implementation efforts at EDF, noting that their experience is consistent with the view that “over 50% of system integration costs are attributed to semantic issues”. Several business cases are given for embarking on an incremental process of Model Driven Integration (MDI) to create a coherent body of semantically-aligned information that will facilitate business transformation. Reflecting the implementation philosophy from other utilities the standardised information model (CIM) was used in a top-down manner to impose design templates on systems and tools in order to deliver the API requirements from several PSAs and bottom-up field-driven applications. The biggest challenge was reported as not technical but getting business participants to agree to a common overall plan.

Other examples of MDI utilising the CIM for a wider range of applications than those described above include its use in facilitating the provision of wide area monitoring data in a standard format for consumption by the EMS or DMS [146], integration of wind data to improve situational awareness [147] and use cases for a data-driven approach to interactive visualisation of power systems [148]. In [149] McMorran *et al* describe the CIM extension (IEC 61970-552) supporting data visualization of CIM-encoded metadata models.

While it is not the intention of this literature review to address all aspects of the IEC CIM and examples of its implementation, the above survey

presents a cross-section of utility EIM efforts and their business cases. In this respect evidence of an alignment between the use case and the business case for the CIM is exposed in Table 1, below. The alignment of context, process and objectives within the given business cases reflects the upper layers of the GWAC Stack and reliance upon semantic understanding to establish E2E interoperability for an information architecture to be fit for the purpose of achieving strategic business objectives.

Table 1. Analysis of reported business cases for IEC CIM deployment.

Utility [Reference]	Context	Procedure	Objective	Business case / Regulatory compliance
EPRI [64]	National transmission grid security	Design interoperability framework from enterprise level	Common standard for model exchange	Improve national transmission grid reliability
	Data integration across planning & operational services	Definition & adoption of appropriate reference architecture	Dynamic assessments based on real time network status	Strengthen planning efforts
		Model management & maintenance governance policy	Common Network Model Management Repository	Facilitate long range planning efforts
		Cross-cutting support to adopt model standards for individual projects		
Powerlink Queensland [144]	Flexible planning of future projects	Worked with CIM COTS product vendor and extended product to meet Powerlink requirements	CIM-based enterprise-wide network asset model maintenance system	Legacy database system no longer supported by vendor
	Standardisation of APIs	Develop a central plant name repository	Build a web view interface	Could not extend database to support new business processes
	Extension of network data model		Automatic update of EMS	Increased data modelling requirements
				Limited access to database by a few users
LIPA [135]	Integration of SCADA/EMS applications	Add CIM functionality to existing SCADA/EMS	Real time stability assessment & monitoring	Bridge gap between Planning and Operations
	Support for load flow studies after generating network model	Establish access to asset data via CIM integration bus	Model present status & future modifications to network	Expansion of capability for data interoperability
		Use operational SCADA to regenerate network model anytime	Run load flow studies anytime using specified operational model	
LIPA [138]	Data consolidation & integration	Company-wide ("top-down") strategy for data modeling and naming.	Simultaneous, near real time use of models for planning and operations	4 KPIs to consider: technical performance (reliability of assets); financial performance (cost and revenue); customer satisfaction; regulatory compliance.
	Create an accurate, single operational and planning model	SOA and tools to ensure data modeling and naming is consistent from the "bottom-up".	Continuous monitoring of models in real time from SCADA	Better asset lifecycle cost and performance management.
		Resolution of semantics across the business with standard definitions	Past event and what-if analysis	The need for well documented data requirements in competitive bidding processes for RFPs

Utility [Reference]	Context	Procedure	Objective	Business case / Regulatory compliance
EdF [145]	Business process automation, activity monitoring, decision support	Top-down approach – generic application of the CIM	Turning many data sources into a coherent body of information	“Over 50% of system integration costs are attributed to semantic issues”.
	Better integration of asset management, planning studies, field maintenance, outage management, customer outage management	Bottom-up approach – address specifics of APIs	SOA with a number of integration buses using company-wide standards-based data modeling	Reduce labour to maintain overlapping data in multiple applications
	New application functionality	Education of different utility departments and stakeholders	Enable IT staff to effectively work with business-sponsored projects	Keep & increase PSA independence
	Effective asset management	Get business participants to agree to same overall plan	Reduce design time effort and errors	Reduce performance errors caused by inconsistent information.
	Data availability & quality	Link architecture closely to BP analysis and implementation	Limit model maintenance issues	Provide least cost approach for timely and accurate reporting on KPIs
	SLAs when switching from one third party service provider	Participate in international standardisation efforts	Solve granularity issues between planning and operational models	Faster implementation of PSA functionality & BPs
	User-friendly data mining and analysis	Model Driven Integration (MDI)	Reusable methodology	Reduce costs to maintain and extend existing applications
	Automation and reporting	Use SME knowledge & gain management attention	Asset management & maintenance optimisation	Reducing risk of project schedule & budget overruns and increased capability to use COTS
EdF [98]	Meter data management	New CIM, 61850, COSEM infrastructure employing ESBs	Advanced Metering Management (AMM) system	Reusable methodologies
	Volt-Var Control & Fault detection	CIM GIS interfaces using common semantic	Advanced Distribution Automation based on CDPSM	Preparation for managing greater amounts of data from AMI
	Migration to MDI solutions	Vendor PSA refresh with CIM interfaces	Integration of GIS into CIM based PSA infrastructure	Compliance with EU Commission mandates (M/490)
	Repository creation	Participation in international working groups and IOPs		Distribution automation
NSTAR & ISO-NE [136]	EMS/SCADA application integration	CIM for model data exchange	Implement new EMS	Increased security and situational awareness
	Exchange of RTO and ISO EMS network data models	Phased CIM implementation	Shared CIM data repository	Ease of model maintenance
		Ensure vendor participation in interoperability tests	Implement Network Model Management System (NMMS)	
			Common network model repository for planning and operations	

Utility [Reference]	Context	Procedure	Objective	Business case / Regulatory compliance
ONCOR [127]	Extension of planning model to adopt details of operational model to support SO	Collaboration between main stakeholders	CIM adopted as model exchange standard	Changing regulatory requirements for member companies to adopt CIM-based model exchange
	Data modeling error reduction	Alignment of common resource definitions in TSO/DSO and SO models	Support for Transmission Network Application training simulator	Reduction in effort required to maintain identity changes to data elements common to all PSAs
	Model consistency	Comparison of models owned by different stakeholders to resolve semantic differences	Synchronised TSO/DSO-SO model changes	SO required to publish Day Ahead network model and RT network model in CIM XML
	Centralised modeling activity for multiple PSAs around a common network model		Combined maintenance for Planning, Operational and Market models within NMMS	Enriched TSO/DSO portion of wider model published by SO
				Greater efficiency through re-use of tools and methodologies as scope of PSA interoperability increases
CAISO [140] [141]	PSA interoperability across different vendors	Migration to common semantic model based on IEC CIM	Unified definition of business concept, independent of business context	New market infrastructure to assure grid reliability
	Faster & more flexible data exchange	Better coordination, control and efficiency of implementation program through approved governance process	Maximise re-usability of logical data models	More efficient & cost effective use of resources
	Data integration & standardisation	CIM extensions to meet SO information requirements in own namespace	Merging network and market models	Strengthen SO computer backbone
	Minimise duplicate data definitions	Implement Enterprise Service Bus (ESB)	SOA technology	Meet requirements for new bidding & settlement system
PJM [142]	EMS-MMS interoperability	Business Service Components (BSCs) shared across architecture	Common model source for EMS & MMS using CME	Streamlined model exchange between MMS for operational reliability
	Common master data model based on CIM/CME	Collect, consolidate model data from existing BSCs and map to CIM. Extend CIM if necessary	Support for AGC and market systems	
		Build common semantic model based on CIM	Support for data warehouse	
		CIM-defined message exchange over SOA with ESB backbone	Support for market monitoring & post market analysis	
ERCOT [129]	Network Model Management System (NMMS)	Leverage existing industrial standards	Incorporate new operational data management systems	Conforming to "Green Button" Regulatory legislation
	Implementing emerging smart grid technologies	Utilise a company-wide CIM RDF-based data schema	Reduce risk of system integration and save time	Merging-in new technology to meet with customer expectations
		Extend CIM to suit company modelling requirements		Lowering socialized cost of grid operation

2.7 Chapter summary

This chapter aimed to set the IEC CIM in context. It started by discussing the smart grid concept and its dependence upon interoperability to establish the reflexive capabilities required to manage the increasingly complex and variable dynamics of modern and future power networks. End-to-End interoperability was presented in terms of the GWAC Stack methodology to highlight the importance of semantic understanding which lies at its centre. The need for semantic understanding within PSA interoperability is reflected in information exchange use cases that call for information standards. The IEC Seamless Integration Architecture was then introduced as the primary standards framework responding to the requirement for information interoperability and communications standards in support of smart grid operation. Within this framework the IEC CIM standards were shown to play a key role in addressing semantic understanding supporting smart grid interoperability and SOA. Further discussion of what the CIM is followed, with a critical review of how it is used to represent knowledge of electrical power networks. This knowledge is derived from integrating the information available from within various power system application data models. Various examples of how the CIM facilitates information integration in both M2M and Enterprise-to-Enterprise use cases were then presented and analysed through the lens of the GWAC Stack.

It is clear from the literature survey of Chapter 2 and the concluding analysis in Table 1 that the CIM can be deployed in support of three essential smart grid information use cases. These are:

1. Information exchange; as an interface mapping standard providing PSA-to-information infrastructure interoperability.
2. Information integration; as an extensible and scalable structured semantic model it enables disparate data models to be integrated into an enterprise-wide body of information (often by means of SOA) thus leveraging the value of data, enabling validation of its quality and opening the access to data silos.

3. Ontology; as a structured semantic model standard representing power system operation, planning, market operation and asset management, the CIM provides ontology for core smart grid knowledge representation. As it becomes more widely deployed and other ontologies (such as IEC 61850) are harmonised with it, it can support advanced situational awareness and the business intelligence required for power utilities to meet the smart grid vision.

In respect of the preceding literature review and discussion of the above use cases the research reported on in the following Chapters addresses a number of opportunities for improvement to CIM deployment methodology, its use and extension of the IEC 61970 standard itself. These opportunities are presented in the following ways:

1. The need to develop smart grid architectures that reflect the emerging operational realities and the need for interoperability by PSAs both within and between utilities. The informational assets and requirements of TSOs and SOs are significant components of such architecture. In respect of operational and planning information interoperability at National Grid, a limited deployment of the CIM has begun that now requires enhanced coordination to continue to integrate within such a strategic vision for the smart grid. The work presented in Chapter 3 addresses this challenge and presents an EIM strategy for coordinated deployment of the CIM as well as a conceptual smart grid informational architecture within which it could be integrated.
2. Complimenting the work reported on in Chapter 3, Chapter 4 addresses the opportunity to deploy novel computing infrastructure that meets the increasingly demanding performance requirements made by interoperability and smart grid data processing to which cloud computing technologies are an attractive and novel solution. So far there has been very little literature reporting on actual demonstration of the use of cloud computing infrastructure to address

cyber requirements of the smart grid and even less that takes into consideration the essential high security and privacy requirements to operate this kind of critical national infrastructure. Chapter 4 goes further by reporting on a demonstration of a trusted cloud infrastructure at National Grid that also utilises the IEC CIM in a practical use case that could be extended to support essential smart grid information processing and exchange.

3. The existing literature generally reports on the CIM concept as deployed within a single XML namespace (“xmlns:cim”). This solution is viable where complete authority and control over resource identities is maintainable. However, where considerations of knowledge engineering become dominant offering benefits from merging multiple representations of a shared (network) reality, the pursuit of imposing a single namespace gives diminishing returns as the number of participating PSAs increase. This is because of the need to maintain an increasing number of reference tables in an attempt to maintain alignment of heterogeneous resource identities. This issue is addressed in Chapter 5 in the context of a model repository and offers a methodology that employs multiple namespaces to benefit the understanding of where metadata has originated. In doing so, this approach extends the applicability of the CIM into increasingly complex and interoperating model exchange scenarios. It also presents an attractive opportunity to develop a knowledge base that supports business intelligence requirements.
4. The smart grid needs to support flexibility in the exchange of energy between supply and demand unlike conventional 20th century grids. To address this requirement there will be an increasingly large range of energy storage technologies deployed that require informational exchanges with planning, market and on-line operational PSAs to maintain adequate situational awareness. So far the IEC CIM associated literature has not addressed this important emerging use case and so Chapter 6 proposes a rationale for energy storage

information modelling and a conceptual extension to the IEC 61970-301 standard that not only supports situational awareness but also offers a bridge to other primary energy vector modelling opportunities based on similar object oriented models.

All of these topics prepare the foundations for presentation of the novel contributions reported on in the following chapters of this thesis.

CHAPTER 3

NOVEL EIM STRATEGIES FOR NATIONAL GRID

3.1 Introduction

The smart grid is a 'game-changer' for the way in which we control modern electricity systems with the need to manage unprecedented amounts of varied information in an increasingly stochastic operating environment. The IEC Common Information Model is a set of core standards supporting power system interoperability that will enable system control engineers to make decisions based on risk and optimization of networked resources. As the balancing of supply and demand becomes more complex from the implementation of renewable energy sources, DERs and advanced metering infrastructures, how to manage multi-variable information about the status of the system to enable its optimisation will require new approaches to information management to provide the necessary situational awareness and conceptualisation.

In this Chapter, SOA and CIM implementation as part of strategies for EIM at National Grid will be discussed. A proposed Information Management Framework and CIM implementation strategy that is new to the utility and addresses the above paradigm is described. Business cases for a high-level SOA design are then presented in support of necessary changes to National Grid and the wider power utility information ecosystem.

3.1.1 National Grid and the GB electrical power network

National Grid is one of the largest investor-owned energy companies in the world. It owns, maintains and operates the high-voltage electricity transmission system (400kV and 275kV) in England and Wales. Together with operating the Scottish transmission system (132kV), it is responsible for balancing UK supply with demand in real time. The electricity transmission network comprises approximately 8000 kms of overhead line and underground cable and around 340 substations at 241 sites. Installed GB

generating capacity is around 80GW, supplying about 300TWh of energy annually with a peak power demand around 60GW. National Grid also owns and operates the gas transmission and distribution system in Great Britain comprising about 7660km of high pressure pipes, 26 compressor stations and 132000km of distribution pipes. In the northeastern United States, National Grid own and operate an electricity transmission network of around 13850km at voltages ranging from 69kV to 345kV with 524 substations and a gas distribution network of about 58000km [150]. They also share ownership and operation of High Voltage Direct Current (HVDC) interconnectors that connect the GB transmission system to those of other European TSO's and Ireland, and in the New England networks of the United States to Canada. Other key stakeholders on the GB deregulated electricity landscape are:

- Generators – have traditionally connected large scale thermal generating plant directly to the on-shore transmission system, but are being joined by a growing amount of wind power plant connecting to the offshore parts of the transmission system. There are also an increasing number of smaller scale distributed energy generators who connect to the grid through the distribution network.
- Distribution Network Owners – own and operate networks which feed out from the transmission network to bring electricity to industry and domestic loads. There are 14 licensed DNOs owned by 6 groups (Fig. 4) and 4 Independent DNOs who own and run smaller networks embedded within the DNO networks.
- Suppliers – are companies responsible for taking meter readings, selling electricity, and maintaining site access to the consumers both domestic and industrial. With the planned roll-out of electricity and gas smart meters legislation and control over the data generated by these is still being formulated within Government.

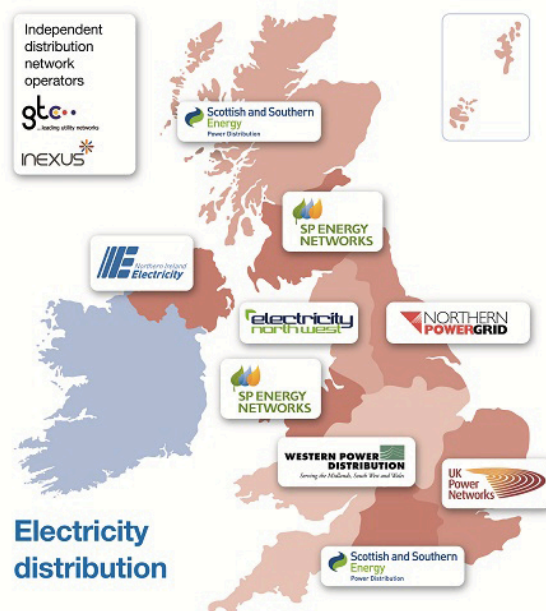

Fig. 4. DNO's in the UK.

3.2 Motivation for MDI

There are a number of motives for taking a MDI approach to power utility business processes and PSA data model management, including:

1. To reveal previously unseen patterns. Improvements to business processes may become apparent, enabling the possibility of their greater integration and control. As common business processes are identified they can be decomposed into services to promote rationalisation and avoid duplication. Fig. 5 shows how complex PSA functionality could be interpreted within a layered information architecture as a selection of *reusable service components* that satisfy common elements of business processes. Re-composing these service components into *virtualised services* to satisfy business process functional requirements would be carried out by a brokerage system within the SOA. When needed, a *virtualised* service can be reused by other parts of the enterprise requiring the same functional componentry. This SOA approach reduces the maintenance for common processes, saving resources and potentially leads to tighter business integration as patterns of service usage are recognised and employed to create a more efficient use of available resources.

- Changes affecting the operation of the enterprise may more easily be propagated through a common model, to keep different functions synchronised with one another. Opportunities may then arise to make new or better uses of assets such as information and plant, leveraging their value. Previously siloed and islanded data can become accessible to a wider variety of systems as this information is shared. For example, patterns revealed from modelling data derived from condition-based monitoring of plant (such as transformers) can improve its service life and reduce maintenance costs.

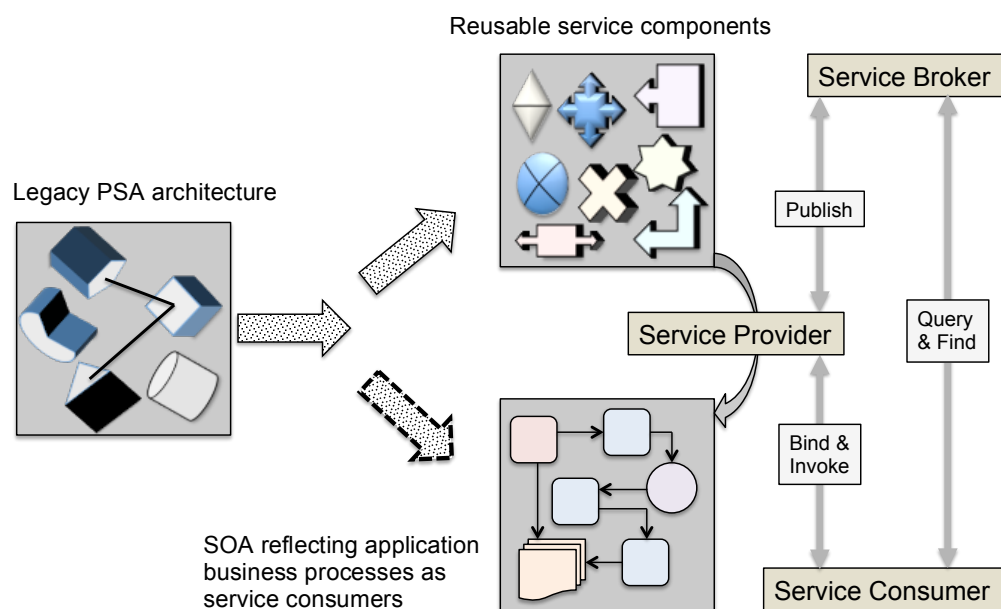

Fig. 5. Business process decomposition. Reusable service components are used to re-construct application process requirements.

- Use of a common information model provides the semantic framework for concepts and terminology to support the building of systems that enable heterogeneous PSAs to communicate with each other and across departmental boundaries. Information architecture requirements for data conversion and bridging are also supported.
- Meta models open a way of sharing information about networks between enterprises as has already been discussed.

5. Experimentation is possible with a model whereas it is often not possible or desirable to experiment with the real entity being modelled. Models open the way to planning and simulating changes to networks without disrupting its service in the present moment in preparation for operational contingencies.
6. This process offers the opportunities for gaining competitive advantage from information and systems as well as helping to maintain the link between strategic business objectives and system development projects. The alignment of online operational and offline planning models would support this.

Relating these topics to SOA, a typical smart grid organisational architecture is presented below in Fig. 6. The LCIM and GWAC Stack concepts are shown to help structure the layout in terms of end-to-end interoperability and the IEC SIA.

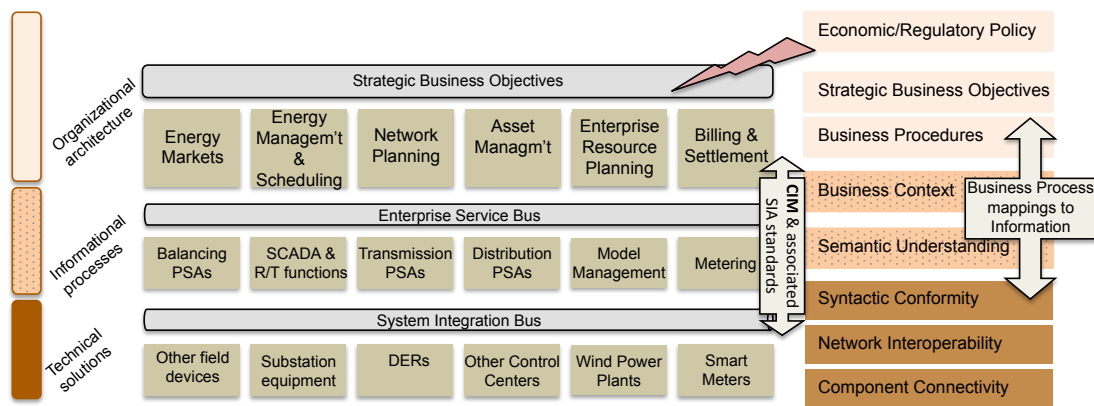

Fig. 6. A typical smart grid organisational architecture. The role of the IEC CIM in supporting end-to-end interoperability is identified.

The IEC CIM and other SIA standards (presented in Fig. 3) form the link between the operational functionality use cases and their informational requirements. A layered architecture is composed from the physical components making-up the electrical power network (Technical Solutions) rising to the Strategic Business Objectives. The CIM is deployed to map data

models created by the PSAs through Informational Process Layers to serve the business processes found within the Business Context and Business Procedures layers. Its object oriented nature is well suited to mapping to the SOA service componentry described in (1) above, as well as providing a common semantic reference model for understanding informational exchanges between PSA and Organizational Architecture.

How the standards making up the SIA may be applied and overlaid upon this organisational architecture are shown below in Fig. 7.

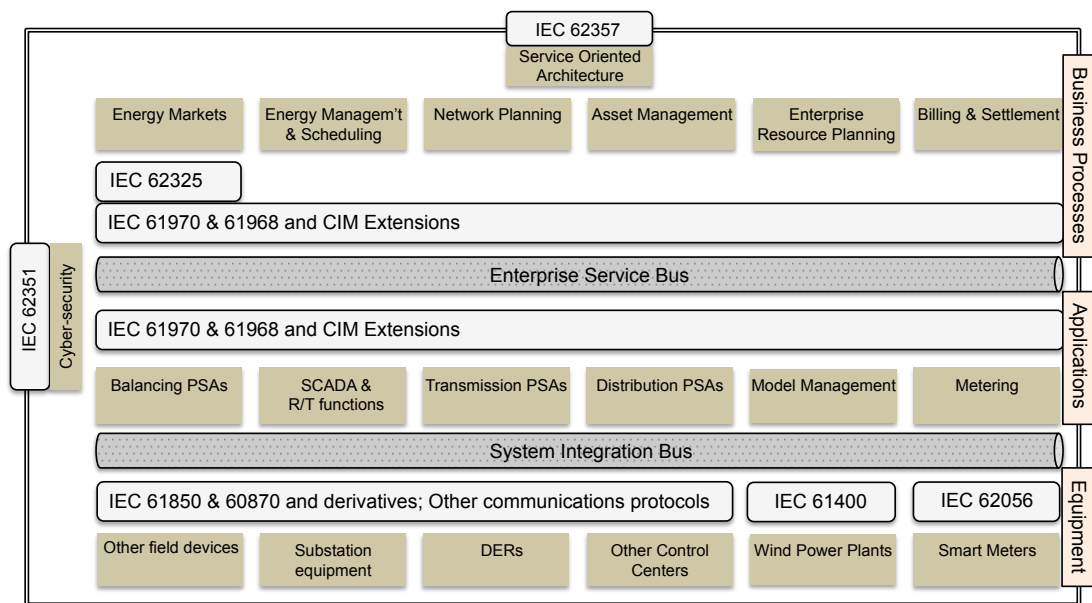

Fig. 7. A simplified representation of IEC TR 62357-1. Seamless Integration Architecture.

While the focus of modelling is often upon achieving a technical solution, a recent research briefing by Gartner [151] regards EIM technology implementation strategies as “secondary” to those involving people. There is also a warning of failure of implementation initiatives if due consideration is not given to non-technical elements. The non-technical issues they describe relate to specific roles within a defined organisational structure, prescribed processes and a governance model for information and metrics that measure the value of information assets with linkage between the EIM program and business outcomes. These are important pointers to any power utility embarking on EIM and so part of this Chapter is dedicated to proposing a novel information management framework and CIM implementation strategy within the National Grid context. Following this, a high-level conceptual

architecture will be presented as a template for very large scale information integration across power utilities interconnected to National Grid.

3.3 Approaching CIM implementation

The implementation of an information model within a large electricity utility is a long-term project with unforeseen outcomes alongside targeted objectives. An enterprise-wide approach would not be embarked upon from the start as this would prove to be overly complex and risky. This is particularly the case in 'open information systems' such as power utilities that are obliged to share information not only within their own boundaries but also outside of them with other business entities. The proven practical approach is to apply MDI to key operational and business systems as their service life demands replacement (about every five years in the case of National Grid), 'growing' interoperability to wider parts of the enterprise from there [98,125,127,130,133,136,140,142,143]. Objectives including improving information integration and creating 1:n PSA interoperability opportunities as well as opening-up previously islanded data have already been described in Section 2. As this process evolves to include more than two applications the requirement to interoperate between several systems offers opportunities to implement a SOA and the use of at least one system integration bus. The advantages of holistically viewing the semantics of enterprise information exchange by establishing a semantic model are clear, guided by implementation initiatives coordinated from the top-down meeting specific data interests of individual projects rising from the bottom-upwards.

An iterative approach concerning EIM, coinciding with system and standards life cycles, is likely. Cycles of iteration could span several years but also be shortened, driven to meet the emerging demands of the smart grid imposed by both regulatory compliance and prosumer technology uptake. In each case the implementation process can be generalised into two steps – *enterprise information modelling* and *enterprise information integration*. Enterprise information modelling (Fig. 8) takes account of what is, while enterprise information integration realises the opportunities arising from applying model driven integration.

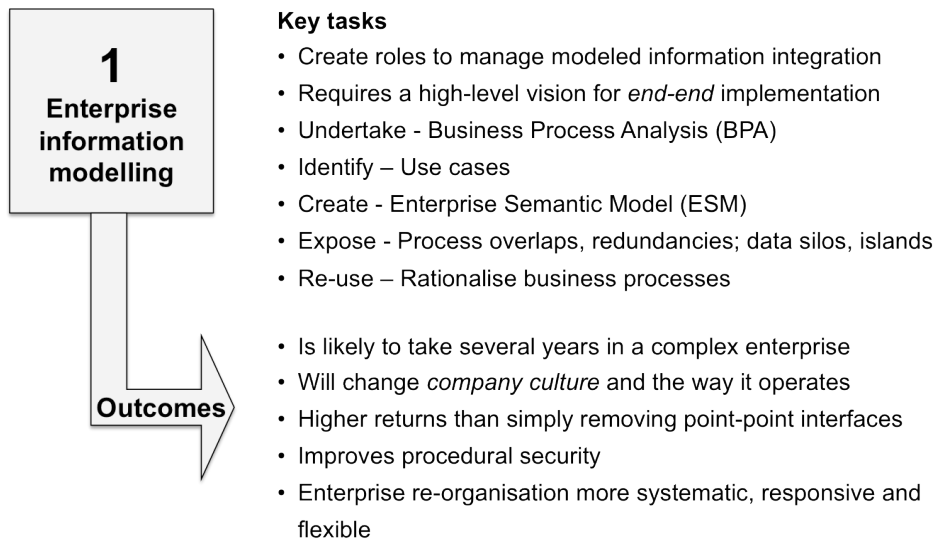

Fig. 8. Key aspects of enterprise information modelling process

Enterprise information integration (Fig. 9) raises the complexity of controls required at application interfaces as well as driving the need for standards to be applied. For example in order for information to be intelligible to other systems its quality will need validation in terms of message syntax, semantics and context. These issues are best addressed through the use of a common information model and will be discussed further in the next Chapter. As it is possible that more than one version of the CIM or other interface standard could exist between PSAs communicating within the same enterprise or between enterprises, version management becomes imperative in order to maintain service levels for *intra-* and *inter-operability*.

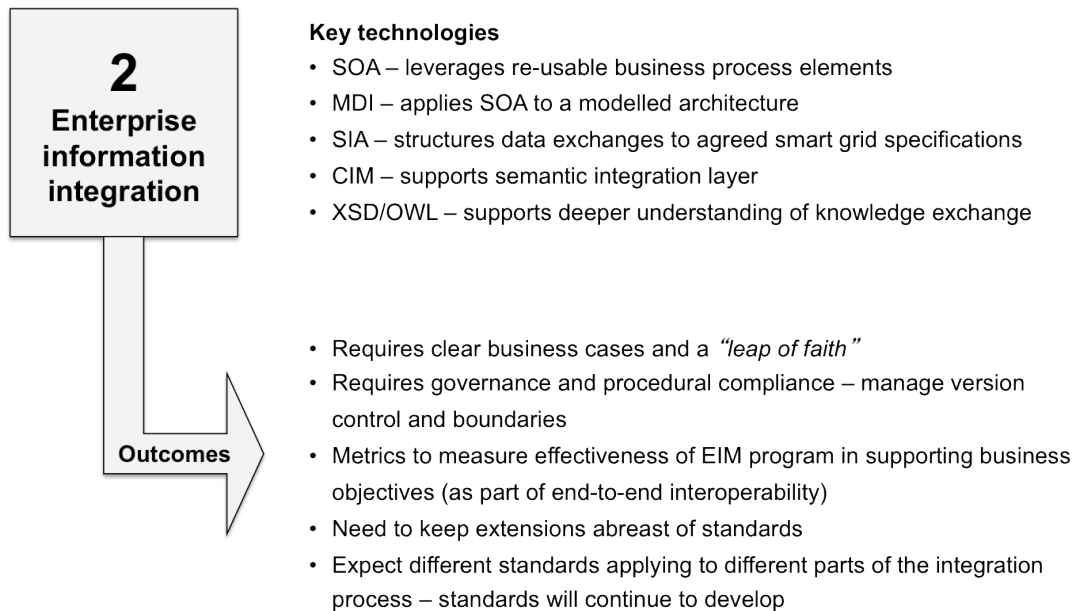

Fig. 9. Key aspects of enterprise information integration process

The issue of persistent, unique, universal identifiers for network resources referred to in CIM metadata models has already been raised in Section 2.6. Names attributed to power system resources such as substations, circuit breakers or transformers are often parochial, legacies of naming conventions when a global identity was not necessary. However, as grids interconnect to become the supergrid and one system shares models and legacy data with another, it becomes necessary to have greater control over naming and identity conventions. Interconnection object registries which attribute unique identities to model objects, known as X-nodes, at system boundaries are employed over geographic regions made up of more than one electrical network jurisdiction. Conventions for this purpose are currently being agreed within the ENTSOE members for example [152].

3.4 EIM for National Grid

In [153] Dolan recognises the requirement for EIM at National Grid to support the radical changes occurring in the GB and wider electricity industry. Some of these he lists as:

- Much greater international cooperation and interdependency for security of supply
- Regional and pan-European market integration and harmonisation
- Decarbonisation of the industry
- Much greater transmission system integration and the introduction of regional security coordination centres

In [153] the number of National Grid PSA interfaces affected in some way by the above factors were estimated to be between 60 and 90 within the Business Plan 10 timeframe out to 2018. An incremental approach of mandatory CIM implementation was recommended under three possible scenarios:

1. On all new PSAs or major asset refresh
2. When carrying out moves in functionality to another application
3. Introducing new functionality to an existing PSA

In this work the commercial and technical benefits to National Grid of a 'universal data model' to have the flexible capability to develop new business processes, reduce data duplication and silos, and keep efficient governance over data are also acknowledged.

Strategic visions such as [12,13] are subject to change in response to economic and regulatory pressures and so require a flexible information architecture to line-up with these constraints – such as timescales and objectives of the UK's decarbonisation targets economic constraints and other fundamental influences as outlined in Section 1 of this thesis. From [153] the need for an information-culture change within National Grid and a commitment to a high-level vision to drive EIM within the organisation became clear. Such a vision must be adhered to and supported by different

business departments to ensure the informational aspects of operational, planning, market and asset management systems align to National Grid's strategic vision. In [154] Hargreaves *et al* report on the initial business objectives now driving CIM implementation and information culture change at National Grid. These objectives are summarised as:

- A. Offer trusted access to databases of shared network models for use by distribution network operator (DNO) transmission owner (TO) and other transmission system operator (TSO) clients.
- B. Offer automated data model exchange with regional network coordination service centres such as Coreso.
- C. Reduce separation between off-line planning and on-line control, network models.

Points A and C form the basis of research that responded to these business objectives and will be reported on in this thesis in Chapters 3 and 4. Before that however, as a product of this research a new Transmission Information Management Framework and Ten-step CIM implementation plan that was designed by the author to support MDI and EIM for National Grid will be presented.

3.4.1 National Grid Transmission information management framework

The Transmission Information Management Framework (Fig. 10) is designed to work from the top-down, providing managerial over view and support for application project and enterprise architecture teams to integrate business data needs into the wider enterprise architecture. These would be aligned with corporate objectives outlined in the National Grid "Operating in 2020" documents [11,12,13] and "Line of Sight" policies for participating business groups. Consistent with recommendations made in [153] it includes new roles created for a team with high level backing and managerial interfaces between National Grid Electricity Transmission Business Groups and Information

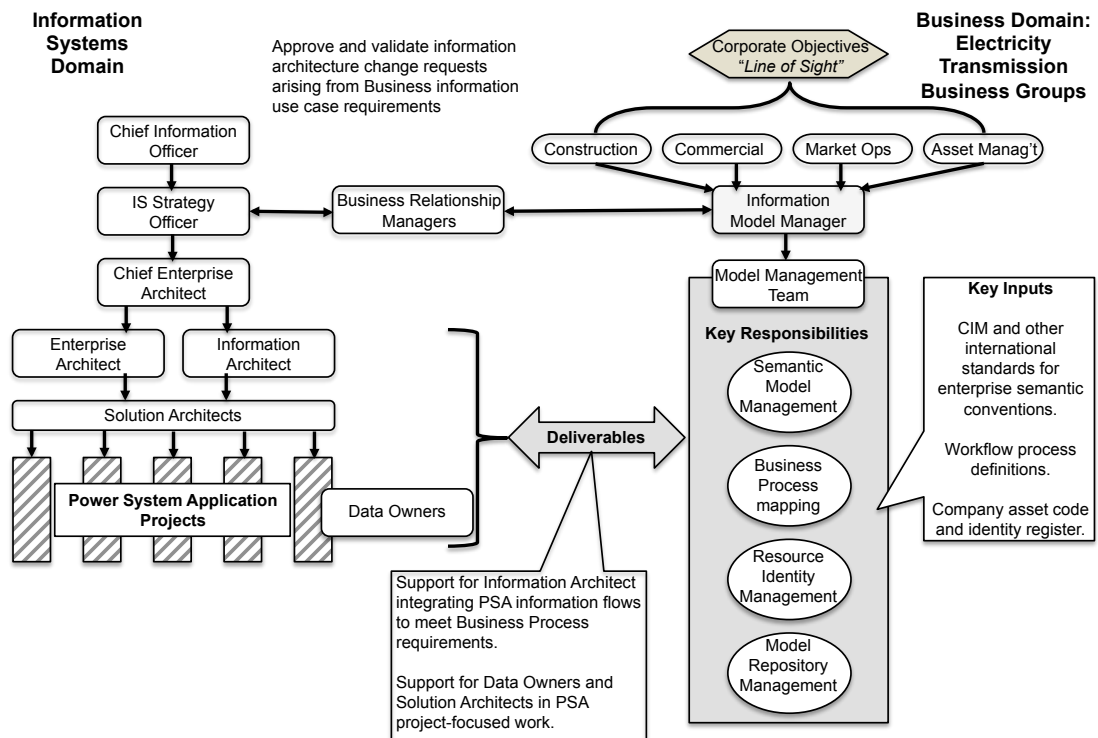

Fig. 10. Transmission information management framework for National Grid

Systems (IS) domains. The 'deliverables' forming the key responsibilities of the team would be the transmission business semantic model, common information model (based upon the semantic model), business process analysis 'maps' and a network metadata model repository. The team would implement, own and manage the 'Transmission common information model' to serve the needs of its different business groups. With overall responsibility for developing and maintaining an integrated PSA common information metadata model based on the IEC CIM, it would take a systems engineering approach to providing solutions for information interoperability. Using the CIM, a priority work stream would be to implement a domain-wide semantic model and gain control over asset naming and identity management from uncoordinated and non-standardised legacy approaches.

Meeting PSA information exchange needs from business process mapping and analysis of process information requirements would inevitably result in developing proprietary extensions to the standard CIM metamodel and therefore add the task of information model version management. The environment in which the Transmission common information model would be managed would be a metadata model repository handling tool. This would

resemble the Network Model Management Systems (NMMS) reported on in [127,129,136]. A novel methodology to improve model handling within a NMMS repository is presented as a major research contribution of this thesis in Chapter 4.

3.4.2 Ten step CIM implementation plan

As part of the Transmission Information Management Framework the author was asked to provide a ten-step CIM implementation plan to give a general direction to National Grid in creating information interoperability based on the IEC CIM, sympathetic to further development of SOA. The implementation plan was derived from analysing reported implementation experiences from other utilities (such as ERCOT, Southern Cal ISO, DTE and Sempra in the USA) and adapted by the author for use at National Grid (Fig. 11). In future there may be scope for developing this further to reference other standards associated to some of the stages of the implementation plan.

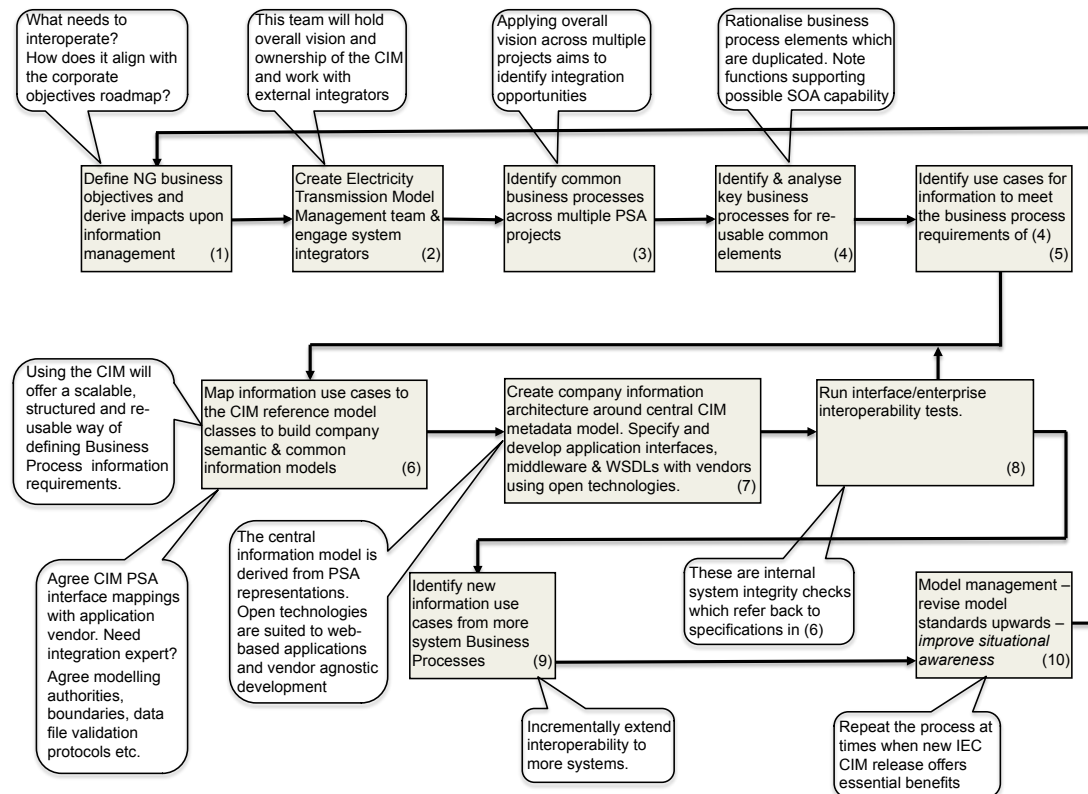

Fig. 11. Ten-step high-level CIM implementation plan

3.4.3 Current CIM deployment at National Grid

Following the recommendations given in Option 3 of [153] National Grid have begun an incremental process of CIM implementation between key operational systems as system refresh options have arisen. Current CIM interface developments are summarised in Fig. 12. CIM adaptors create interfaces between the EMS, the Energy Balancing System (EBS) and the Data Historian (DH). A CIM interface also exists for OLTA in both Operational Planning and Asset Management departments. In the Operational Planning department it is currently being used to export a reduced network model to Coreso representing the part of the GB transmission system interconnecting with the French and Dutch transmission systems. This model is used by Coreso for transnational system security assessments at system boundaries. In the Asset Management department it is being used to support the ENTSOE network model database for member TSOs as part of their Ten Year Network Development Plan initiative. The Planning and Operational Network Database (POND) and Ellipse, which are connected to both OLTA systems, respectively are possibilities for future CIM interface enhancements as both of these databases serve operational and planning data requirements fed by a number of third party data resources.

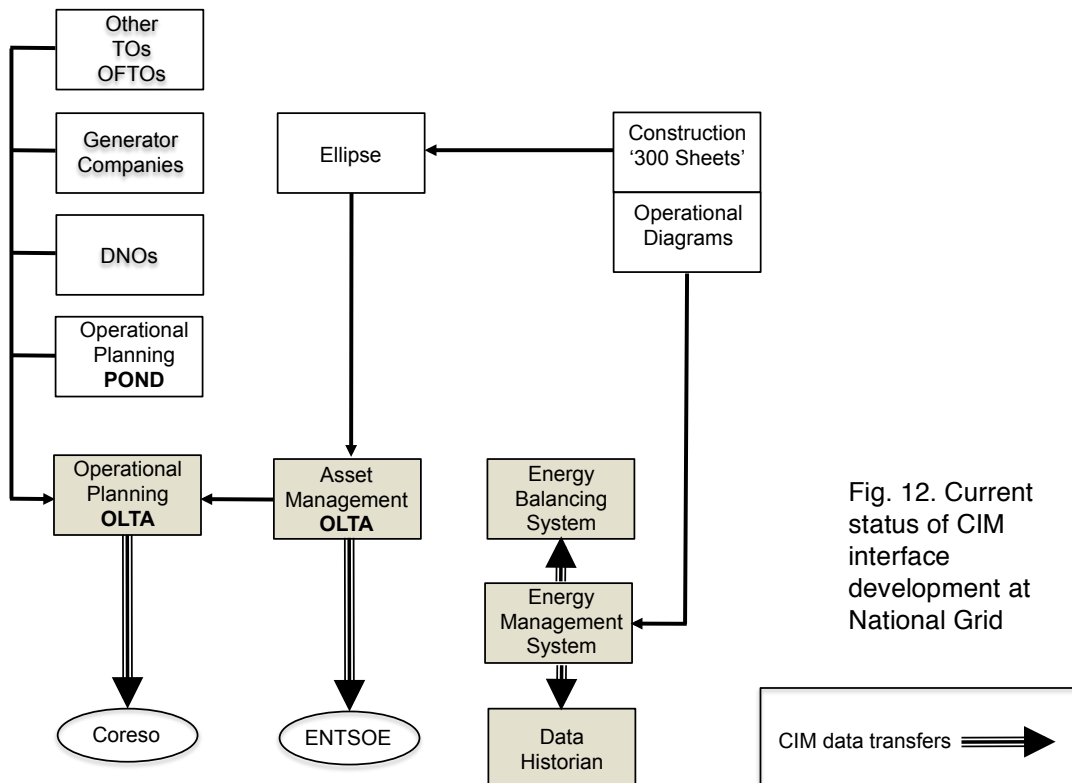

Fig. 12. Current status of CIM interface development at National Grid

At present there is not a single source for online and offline operational models although the concept of an information bridge between them is particularly appealing in terms data integration for the following reasons:

- Alignment of the online operational network model with the offline planning model would present a more coherent perspective of the enterprise. Cross-departmentally there would only be 'one version of the truth' upon which all network security (Power Network Analysis – PNA), contingency planning, network development, maintenance and outage planning, and asset management could be based.
- There could be the option to only enter critical data once, and beyond that it would automatically be posted to subscriber systems. This raises the concern of data quality, such that inaccuracies are not rapidly propagated around mission-critical systems, and therefore calls upon additional data validation and 'sterilising' measures to be implemented at points of entry. These could be addressed by adherence to CIM validation procedures.
- Integration of these key systems would theoretically support less inaccuracy in data entry and enable faster processing of new information as human interfaces between systems are removed, raising the potential to respond faster to demands upon the network. As the level of data being exchanged increases as more complex generation and demand-side scenarios emerge reducing the amount of human contact with data entry is inevitable.
- Interoperability of the EMS and OLTA PSAs could unlock valuable data used by each application. For example, at present the network connectivity model held in operational OLTA's database is of a higher resolution (node/breaker) than that within the EMS (bus/branch), while asset management OLTA holds a topological network model in high resolution. A combination of these models could potentially offer a

regularly updated, powerful resource for other business systems extending from real time to several years in advance.

Further standards-based interoperability between operational PSAs, in particular between the EMS and OLTA for operational planning, would therefore be necessary for National Grid to operate a NMMS. There are also opportunities for developing improved standards-based data exchange resources for National Grid customers. Sometimes referred to as a “Grid-user Data Service”, this would manage the information exchanges between GB electricity utilities (DNOs, OFTOs, TOs) and extend to support other parties as well, potentially including meteorological services, data management services and electricity suppliers (see Fig. 30). As the number of participating utilities increases, the sharing of data models and also similar data processing application services will increase the attractiveness of MDI for EIM and EAI as discussed in Section 3.2. A complementary information architecture to support this process is a SOA [59, 139, 140, 142]. In [155], Becker and Saxton describe SOA and Web services as a “robust” services environment although independent of content. This architecture could then engage semantic web technologies and use publish and subscribe methods to update subscriber databases as well as offer reusable data manipulation services.

3.4.4 A high-level SOA for National Grid

Following EIM procedures as described in the previous Section, the opportunity for viewing the information exchanges of PSA applications in terms of ‘information services’ as described in [52,54,55] becomes a possibility for National Grid to leverage more flexible and efficient use of its information resources. The legacy of applications and information architecture operating the GB electricity transmission system has created a complex web of point-to-point system interfaces at National Grid. From information supplied in [153], Figure 13 has been drawn to illustrate these interfaces. PSA interfaces have formed around bespoke point-to-point arrangements, often locking the utility into expensive support from particular application vendors and requiring considerable manual support when data in different formats is entered and

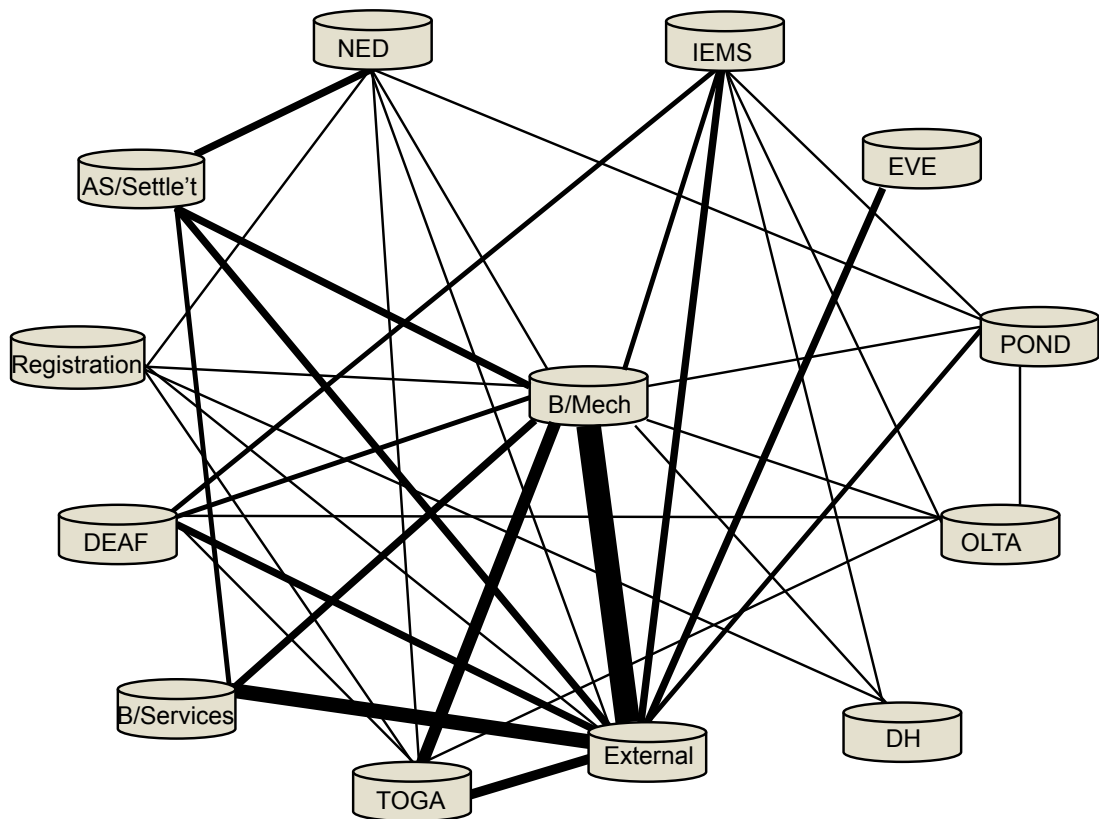

Fig. 13. Key National Grid operational system interfaces. Line thickness reflects the number of data flows. 'External' represents flows from or to National Grid. Source: [153]

exchanged between non-interoperating systems.

This problem is encountered in information exchanges with TSO customers. For example, under Grid Code regulations network boundary models are exchanged between the TSO and DNOs on a regular basis. Currently a DNO can submit data in one form, such as an Excel spreadsheet that then requires error-checking, calibration and validation before being manually entered into the National Grid OLTA database for future network security assessments. This process could lend itself to greater automation through the use of a standardised data format corresponding to the CIM carried over a secure information infrastructure. Such a procedure will be described in Section 4.5 of the next Chapter.

The transition to SOA for operational, planning and asset data at National Grid, as in other utilities, could be justified once the level of PSAs using the CIM to interoperate has increased much beyond the current number. However this process could be significantly accelerated if a centralised NMMS was implemented to serve as the primary source of

network knowledge representation. A projected high level evolution to SOA from the current point-to-point architecture based upon the use of an ESB as a system integration bus is depicted in Fig. 14, below. In this vision, essential online and offline operational systems including the EMS and EBS with the planning and network analysis functions of OLTA are shown as a starting point for the SOA. These are supported by the Demand Energy and Forecasting System (DEAF), data warehousing functions of the Data Historian (DH) and asset database Ellipse. Currently National Grid exchange CIM-based metamodels from the EMS to the EBS and DH but as yet bilateral interoperability has not been achieved. Advantages similar to those reported in [127,129,136] of aligning the EMS operational data model with the offline planning model held in OLTA have also not yet been realised but would stand as a major evolutionary milestone.

Extending outwards beyond internal National Grid architecture to include other stakeholder utilities, Hargreaves *et al* [156] propose the development of

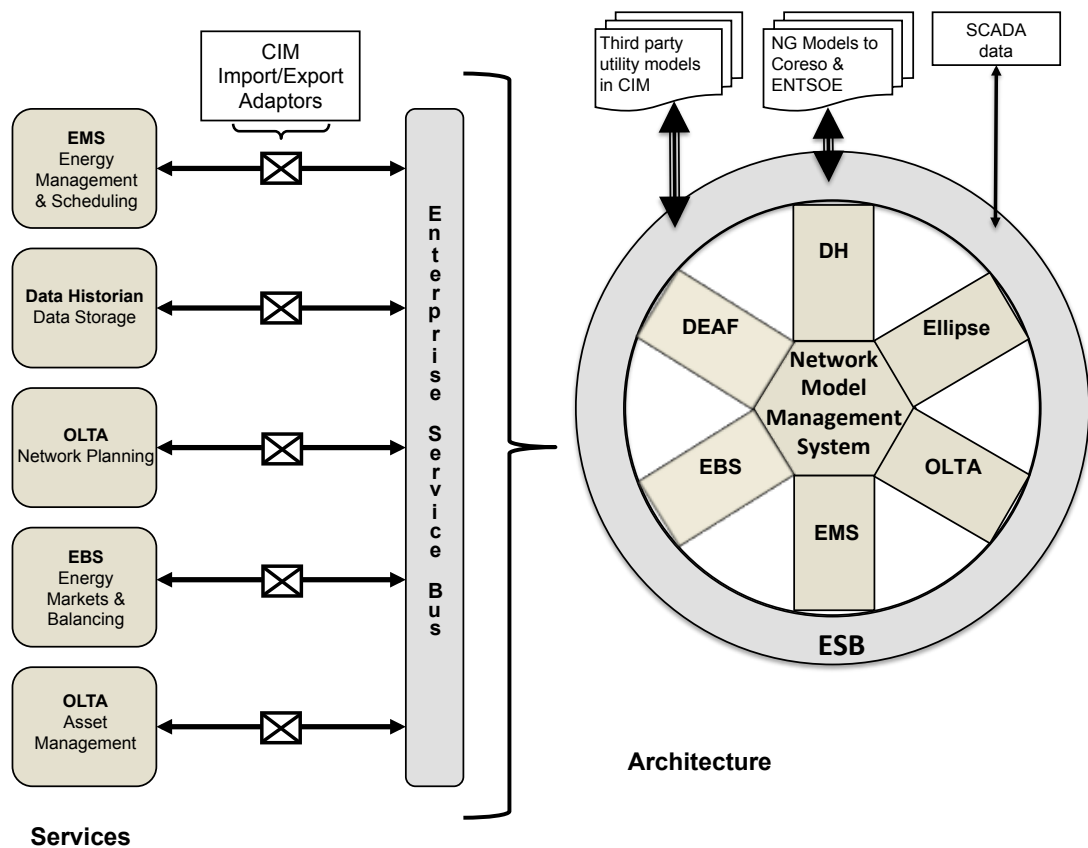

Fig. 14. Potential evolution of National Grid operational PSA information architecture to SOA.

a very large scale information architecture for integrating data flows based on a similar 'hub and spoke' design (Fig. 15). The evolution of such a scalable architecture was likened to that of very large scale integration found in electronic circuits (because the design template is repeatable) and presents a compelling argument for addressing the future needs to manage, align and integrate the massive information flows between the cyber-physical systems and stakeholders of the emerging transnational smart grid. How the actual infrastructure supporting this information architecture could look and the real issue of cyber-security are addressed in the following Chapter.

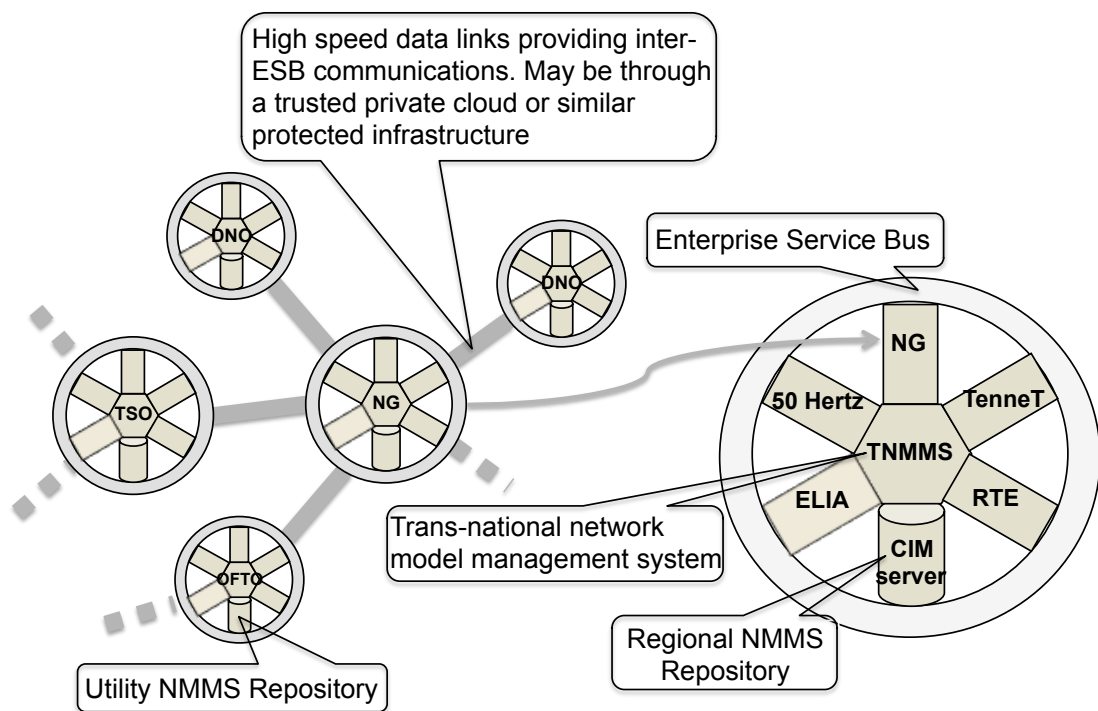

Fig. 15. Very large scale transnational SOA.

3.5 Chapter Summary

This Chapter has addressed novel EIM strategies for National Grid on two levels. Firstly the value of implementing the CIM as part of a service oriented architecture was addressed. A new Transmission Information Management Framework was presented to facilitate the implementation and management of modelled information within the transmission operation business domain. Following this a Ten-Step CIM implementation plan was outlined to facilitate a re-usable approach to developing greater CIM-dependent interoperability

between National Grid PSAs. Then a novel high level conceptual SOA was presented to indicate how application of the CIM and EIM principles may be visualised within National Grid and extended further to create the enterprise-to-enterprise interoperability upon which the wider smart grid will be built.

CHAPTER 4

ADDRESSING EMERGING SMART GRID OPERATIONAL REALITIES

4.1 Introduction

Changes to the design of modern electricity systems to provide the flexibility required by the smart grid will require operational paradigms to change [157]. As they are influenced by greater degrees of non-deterministic supply and demand, the assessment and management of risk is rising in importance to maintain reliable, secure and balanced system operation [158,159]. A greater number and frequency of studies will be necessary to provide utility control rooms with sufficient situational awareness and decision support capabilities. Management of the grid will then be decided within temporal and operational envelopes. This chapter aims to quantify some of the most significant changes to electricity system operation from a National Grid perspective and proposes that the use of emerging cloud computing technologies could address some of the computational and information-handling requirements underpinning management of these new operational challenges. The second part of this Chapter will describe the demonstration of a novel scalable trusted cloud solution designed to support National Grid operational information management.

4.2 Emerging smart grid operational realities at National Grid

In quantifying the need for changes to network operational paradigms we will discuss the following areas:

- A. Changes to network design
- B. Changes to generation and demand
- C. The influence of the environment
- D. Impacts upon network security
- E. Challenges to balancing and operational awareness

A – Changes to Network Design.

The smart grid calls for radically different functionality over legacy radial systems with increased interconnection and meshing of distribution network configurations. The movement of generation to the edges of systems away from load centres is changing the patterns of flows, requiring updating and reinforcement, in the case of the GB system, to manage these changes. In response to this, National Grid is changing its approach to system control with the implementation of tools like Quadrature Boosters (QBs) to adjust the amount of flow and Static Var Compensators (SVCs) to adjust the composition of real and imaginary power within the flow. High Voltage DC (HVDC) reinforcements, supplementing AC transmission lines, are also being implemented on parts of the GB transmission system. System complexity is increasing with more interconnection to transmission networks across different countries and offshore transmission networks. It is becoming possible for power flows, driven by market forces and ‘network as a service’ availability, to simply wheel through national and international systems without necessarily responding to local demand.

B – Changes to Generation and Demand.

The implementation of increasingly large proportions of renewable generation requires the way in which we manage supply and demand to change [160]. A change in our perception of supply as we move from thermal to environmentally-dependent VERs will be required. The outputs from growing amounts of small-scale DERs will also require aggregation to provide system control engineers with a clearer picture of supply. Energy storage offers a scalable opportunity for supply and demand at all levels of the market, spanning domestic to transmission applications. Storage technologies will provide services to electricity networks ranging from power quality and frequency stability to outage support and arbitrage depending on the power and energy they discharge. In combination with demand-side response (DSR) technology arrangements, they have the means to contribute smoothing to variable supply and demand scenarios when weather-dependent renewable energy resources make large contributions to meeting electricity demand. The utility of storage technologies could be

rapidly released in smart grids when their capabilities are marketised and their cost is commensurate with their use cases.

With the opportunity for consumers to schedule their demand by following electricity pricing signals through AMIs it is possible that we will see swarming trends in consumption that could also be modified by the presence of storage technologies. These patterns will add to changes in the baseline demand for heat and energy in domestic and industrial processes as decarbonisation legislation drives efficiency measures through these sectors towards 2050. Historical demand data will no longer reliably reflect consumption across the smart grid as consumers are incentivized to generate from renewable sources (such as domestic-scale photovoltaics) as well as to migrate to electric vehicles. The overlay of these factors will add to the probabilistic nature of demand as the level of embedded technologies, such as heat pumps and combined heat and power units for example, continue to be socialized and mature.

C – The Influence of Environment.

As carbon-emitting thermal generation is limited in favour of renewable energy technologies, the circle of weather-dependency, which hitherto mainly affected network infrastructure and demand, will become closed by weather-dependent generation (Fig.16). Control centre engineers now need to be increasingly weather-aware as they dispatch power to meet demand.

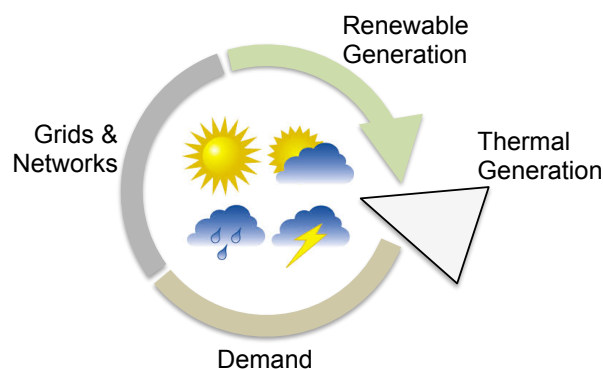

Fig. 16. Weather dependency of modern electrical power networks.

As the proportion of VERs supplying the system increases, weather and some other environmental forces found in the ionosphere (solar storms) and hydrosphere (wave speeds and tides), could become the dominant concern behind pricing, reflecting our ability to deliver electrical energy when and where it is required. Adding to the difficulty of predicting the impacts of weather on scheduling and planning for smart grid operation, the impact of global warming in amplifying weather pattern extremes, will increase the risk in using historical data as well.

D – Impacts Upon Network Security.

Planned and unplanned outages, as well as the available service margin on network components, from where a line is operating in respect of its rated capacity, will drive network re-configurations. Complex automated fault switching sequences will be required to maintain n-1 and n-2 security contingencies as network configurations change more frequently to accommodate variable operating conditions. Transmission grids will have to become smarter to ensure the safe, reliable and economic delivery of energy to consumers at all levels.

The price of smart grid electricity is affected not only by the cost of emissions and type of generation plant but also the operational status of the electrical network at its time of delivery. This means that securing future networks will employ means to reconfigure demand in line with dynamic line conditions. The status of line capacity at a given time will also affect the cost to generators of using the lines to deliver supply. The effect of these measures will be to drive infrastructure closer to dynamic capacity ratings, which emphasizes the importance of smart and flexible networks to readily respond and control centres to have adequate situational awareness. It will also potentially result in more frequent line switching events, providing another unpredictable constraint to system management within the control centre.

E – Challenges to Balancing and Operational Awareness.

The forecasting of demand ahead of real-time for scheduling generation is a risk-based operation due to the combination of effects described above to

which the smart grid will add greater complexity. Historical demand data is used to compile forecasts for the anticipated national demand (National Demand Forecast) and in response, generation is scheduled (Indicated Generation Forecast). This is illustrated in Fig. 17. showing the National Demand Forecast and Indicated Generation Forecast for the GB system on a typical day in July. Data is derived from historical records belonging to National Grid and excludes interconnector flows. A margin of generation for contingency requirements is set between the two curves (Fig. 17).

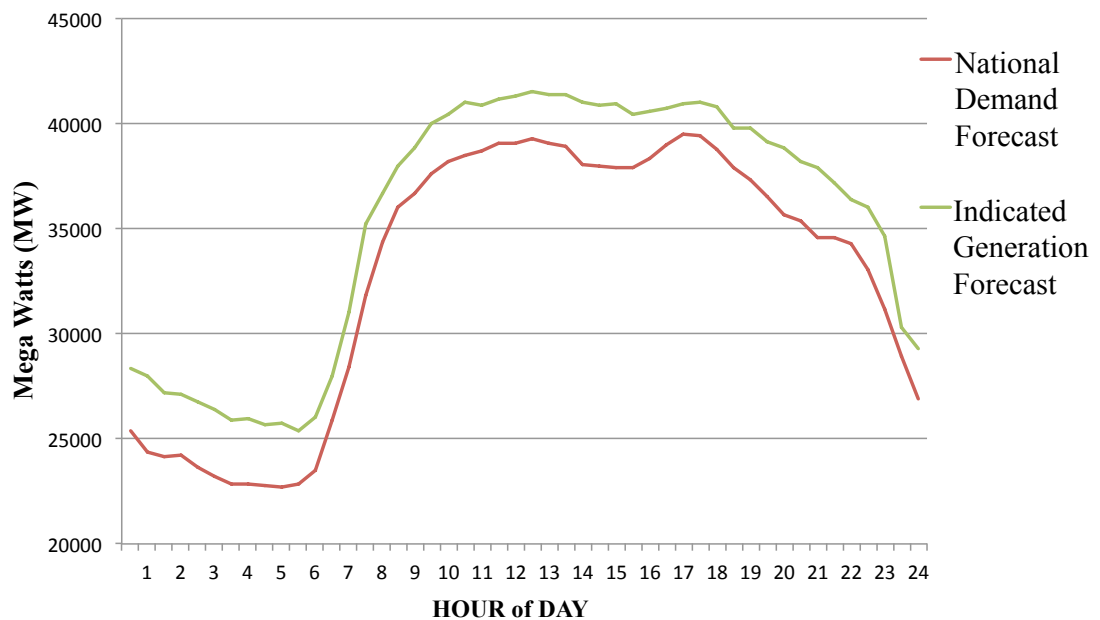

Fig. 17. National Demand Forecast and Indicated Generation Forecast. Data from National Grid, National Demand Database for 18 July 2012.

As the smart grid absorbs a greater proportion of environmentally-dependent generation however, and demand is driven by a for number of control inputs, the process of balancing for the control centre engineer will become increasingly stochastic. In Fig. 18, we project operational data to show possible demand and generation forecast scenarios that reflect the impact of increased proportions of VERs to illustrate the challenge of balancing dynamic conditions within a smart grid scenario. This projection was achieved through the use of two sets of data recorded on different days to generate each curve. Ultimately, the success of control centre actions to converge supply and demand curves is indicated by the frequency and voltage deviation from statutory values.

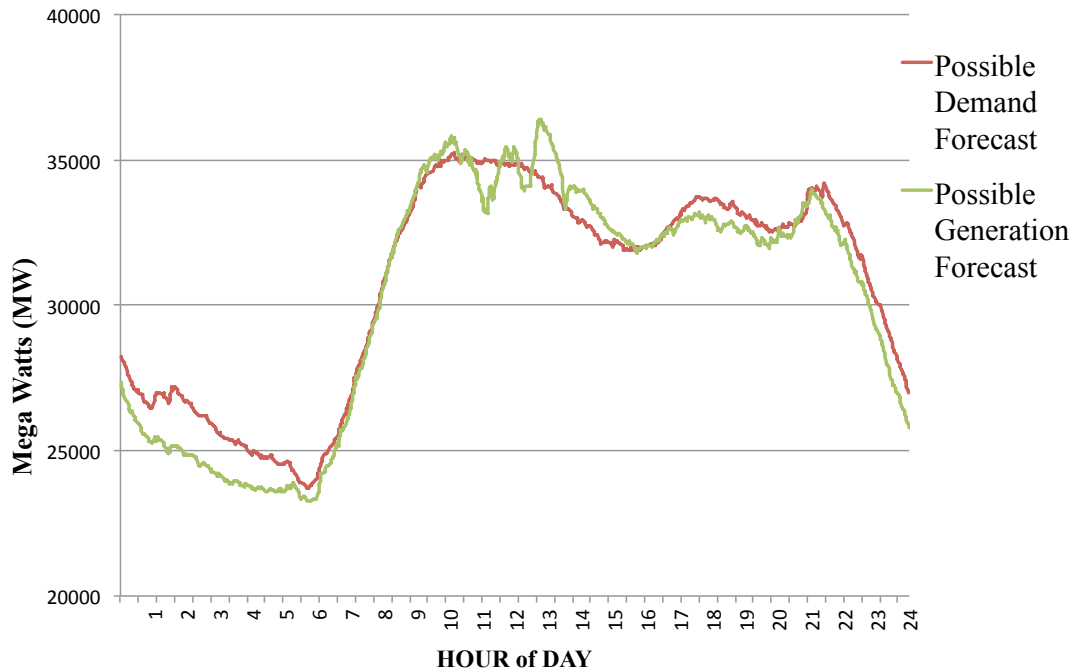

Fig. 18. A demand day scenario projected against generation with a high proportion of VERs. Data from National Grid, National Demand Database. Demand Forecast recorded for 2 May 2009; Generation Forecast recorded for 29 April 2011.

The above survey of emerging operational realities facing National Grid gives some background to the vision of managing the smart grid within *operational envelopes* that change temporally to meet the variables of supply and demand. This new concept is being developed at National Grid by forecasting energy patterns to prepare the system for optimal configuration in real time. Preparation for real time operation begins by running network studies based on windows of time up to a year in advance. In Fig. 19 a schematic of this process is given with studies represented by the dots inside the graph leading to the Optimum Operating Point. The longest range studies rely upon archived supply and demand patterns together with planned asset maintenance schedules. As the 'Optimum Operating Point' in real time approaches the time window in which an increasing number of studies takes place gets shorter. Actual supply and demand data, market, interconnector and meteorological data are fed into the studies to represent prevalent conditions. The resolution of these studies also increases as real time is approached requiring an increasing rate of studies to be carried out. Overall there is a process of convergence between the anticipated energy scenario and a secure operational envelope representing optimum readiness of the

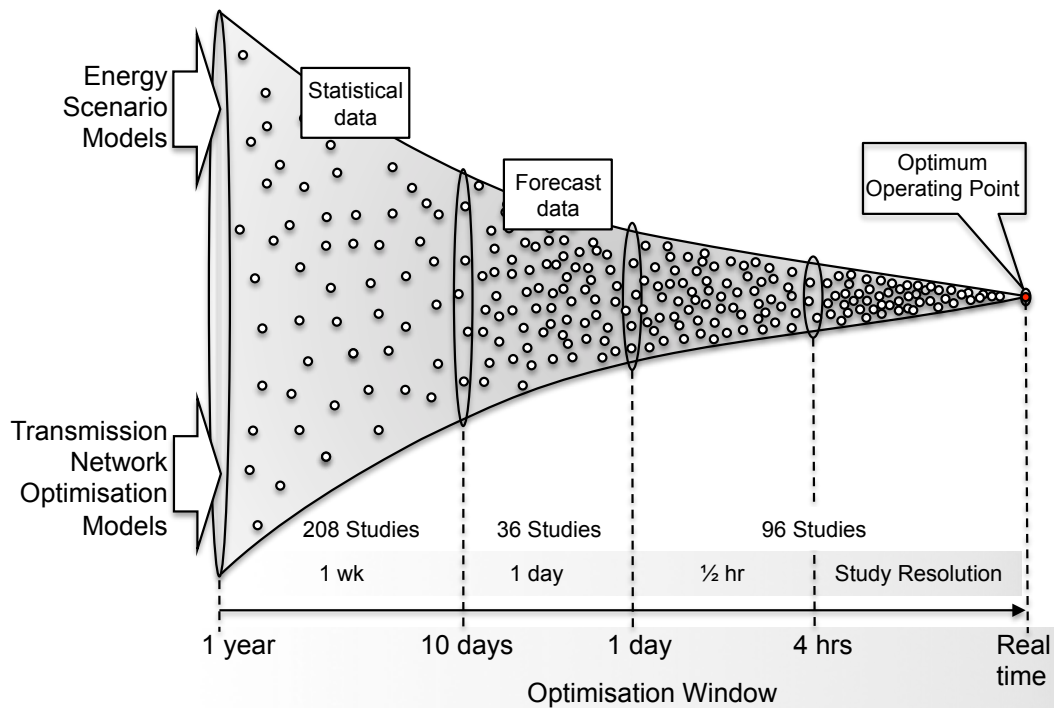

Fig. 19. Operational envelopes for system balancing at National Grid.

transmission network at real time. Operational data is also fed back into the stream of future studies to adjust baselines in accordance with the real time status and environment of operation.

This new way of managing stochastic operating conditions to arrive at a balanced system depends on reusable data management processes. Because of the variable number of studies and amounts of data processed it is ideally suited to elastic computational systems. There is a range of static and variable data concerning both the network, energy supply and demand that contribute to the development of the converging scenarios. Models relating to transmission information and supply and demand must be shared and compared for this process to reach a secure and cost effective solution to the optimum operating point for system balancing. How these models are handled and processed forms the background to the research reported on next.

4.3 Cloud computing and EIM for the smart grid

In [161] NIST have succinctly defined the emerging paradigm of cloud computing with the following definition:

“Cloud computing is a model for enabling ubiquitous, convenient, on-demand network access to a shared pool of configurable computing resources (eg. networks, servers, storage, applications and services) that can be rapidly provisioned and released with minimal management effort or service provider interaction.”

Clouds have essential characteristics that distinguish them from their predecessors in data centres and high performance computing systems. They provide a metered charge for elastic, on-demand services that respond up and down to the consumer’s computing requirements of processing power, server time, connection bandwidth and storage. Connection to a cloud is normally through thin or thick clients over standard network architecture that utilises pooled resources to serve a variable number of clients. There are three particular service models ranging from Software as a Service (SaaS), through Platform as a Service (PaaS) to Infrastructure as a Service (IaaS). Fig. 20 shows how cloud service options relate to a traditional computing environment. These configurations offer the user an increasing amount of control over the layers of the cloud infrastructure. In the abstract layer applications are deployed and virtualised above the physical layer, where hardware supporting the abstract services resides. In [162], Abbadi describes

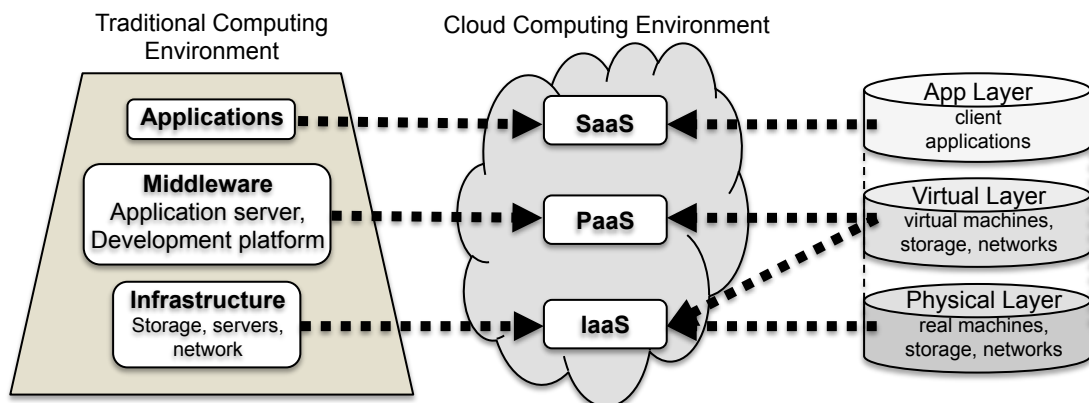

Fig. 20. Relationship between traditional and cloud computing environments

the cloud environment as a series of layers supporting the services required by the client. A physical layer comprises the infrastructure (servers storage and networks) upon which the virtual layer and application layer are based. In the virtual layer domains are created to contain virtual resources used by a client that include virtual storage, virtual machines (VMs) and virtual networks. It is in the abstract layers (application and virtual layers) that the virtues of the cloud computing model, including scalability, elasticity, adaptability and resilience are manifested. It is also in these layers that the cloud is most exposed to privacy and security considerations. Clouds may be deployed according to four models ranging from *Private*, which is exclusive to the applications of a single client although the infrastructure may be owned by a third party, to *Community* and *Public* models where increasing numbers of stakeholders gain access to the cloud. The fourth deployment model is a *Hybrid* which is a composition of the above configurations bound together by technology that allows data to be shared.

It has been shown that cloud computing could be used in a fully functioning smart grid to flexibly manage and modulate supply and demand from signals of energy availability and price in near real time down to the domestic level of consumption [163,164,165,166,167]. Added to this, the requirement to operate in a far more environmentally responsive manner will necessarily involve processing unprecedented amounts of data to improve the situational awareness of power utilities [168]. The wider use of Phasor Measurement Units (PMUs) and other Intelligent Electronic Devices (IEDs) deployed within substations for example, will generate much of the data required for advanced state estimation techniques. As a cyber-physical entity, the full functional value of the smart grid, dependent as it is upon information interoperability and integration, may not actually be realised until the available data generated about it is “ingested, processed and analysed into meaningful decisions” [169]. In one smart grid demonstration project carried out in Los Angeles, Simmhan *et al* report that the municipal power utility with 1.4 million customers would be required to process in the order of terabytes of data daily [170]. In [171] Maheshwari *et al* estimate 7.2Gb of data per day from a modest network of 10 PMUs. This magnitude of information exchange calls for similarly scalable, elastic and resilient ICT that can operate at

minimum cost and maximum availability while at the same offering acceptable levels of security and data privacy.

4.4 Cloud computing trust and privacy considerations

Concerning data management, the smart grid is often framed with a focus on the consumer end of the power network where significant amounts of private data will be generated due to new AMIs. However there are two other major smart grid stakeholders that will need to engage with increased volumes of data. These include third party data management companies and the power utilities themselves. Common to all three stakeholders are the concerns of security and data privacy. While cloud data processing characteristics may very well be suited to the data processing requirements arising from the smart grid challenges described above, there is concern for cloud security and privacy that needs to be addressed further. For example, the power and flexibility of public cloud solutions such as Microsoft Azure (PaaS) [172], Amazon EC2 [173] and Google AppEngine [174] while attractive to smart grid data processing requirements also increase the 'surface of attack' to intrusion, and vulnerability to denial of service that would currently be unacceptable to power utility management of critical national infrastructure, despite typical service level guarantees by these providers quoted at 99.95%.

For these reasons, portions of utility businesses requiring high levels of security and data privacy are most likely to seek private, regulated community, or possibly hybrid configurations where clouds are deployed. A trusted cloud infrastructure developed for use at National Grid is reported on in [175] and provides a novel solution to the management of regulated data model exchanges between DNOs and National Grid. In [171] encryption of data passed over the internet to and from the cloud is recommended as part of a number of security measures to suit smart grid utility requirements although in [170] Simmhan *et al* say that this measure may become time and cost consuming when meter data transfers amount to petabytes annually. Pseudonymisation is also a technique used to code the origin of data, de-identifying its owner [176]. In [161,177] Abbadi and Namiluko discuss the issue of establishing operational trust in a cloud from the two perspectives of the

cloud provider and the cloud user. Establishing trust in the infrastructure supporting the cloud naturally strengthens the trust that the cloud user may have in the cloud. It is the dynamics of cloud management and layered service composition that ultimately formulate the cloud's capabilities as well as its trustworthiness. Less error-prone human interaction, more operational procedures and automated management of services could lead to better cloud operational service delivery. Automated, self-managed cloud infrastructure is recommended as a design feature for improving cloud capabilities [177]. Secondly, as a cloud architecture is layered this leads to the proposition that the 'shortest chain of trust' to provide virtual resources with their physical requirements is likely to create a more trustworthy and transparent service. In addition, should the composition of the trusted chain of entities change, then re-evaluation of the state of the new trust chain should be made to re-establish its trust and provenance. Thirdly, a 'Transparency Strategy' is called for to establish the optimum balance between the process of trust evaluation (as described above) and the provision of information to the user about the status of the services running their applications within the cloud. This information would highlight information about failure of services for example, providing transparency to the user of replacement by alternative resources.

4.5 Development and demonstration of myTrustedCloud

While deploying a private cloud can be solution to security and privacy concerns, there are other concerns due to the amount of investment required in hardware, applications and management resources. These concerns also apply to open source software solutions such as Eucalyptus [178] despite the elimination of licensing fees. The myTrustedCloud (mTC) project [175] engaged the Author in collaboration with Oxford e-Research Centre [179] and Open Grid Systems Ltd. [180] to investigate these concerns, focusing on a business critical use case to the process of establishing operational envelopes at National Grid.

4.5.1 Use case analysis

Recognising that many power utilities do not alone have the infrastructure and computational resources to support the need for a growing number of network studies and simulations called for by the smart grid, the mTC project aimed to satisfy these requirements and avoid over-investment by individual companies. The use cases considered were therefore based on information interoperability between multiple organisations and suited a private community cloud model. Opportunities to deploy this model were evident in two distinct information interoperability requirements (Figs. 21 & 22).

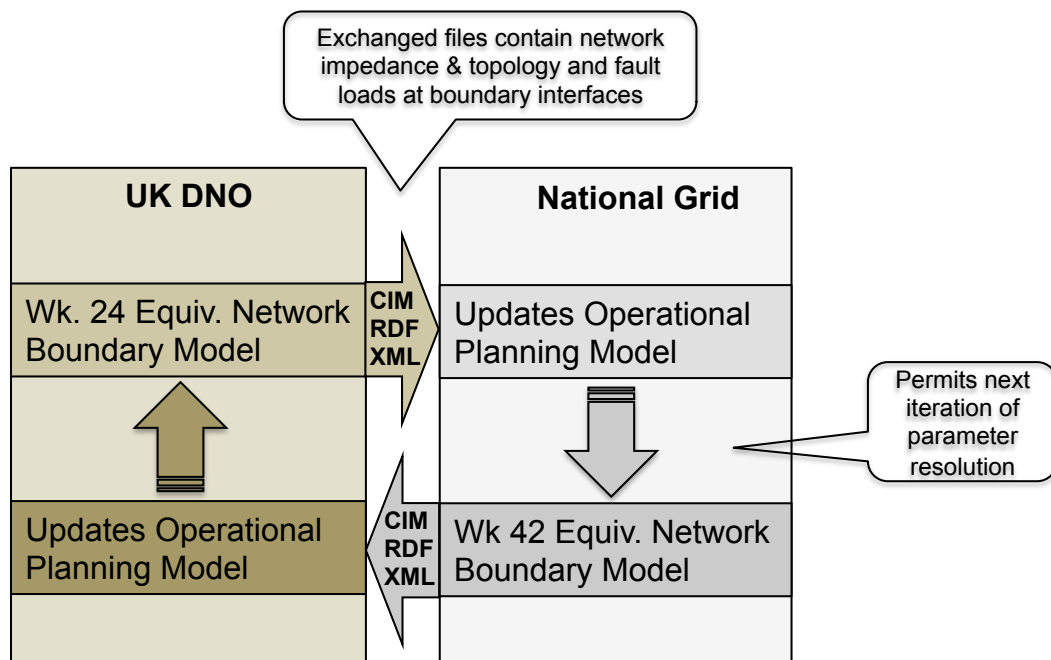

Fig. 21. DNO to National Grid planning model exchange process.

In Fig. 21. the exchange of operational planning models between DNOs, Scottish TOs and OFTOs and National Grid as part of statutory GB Grid Code regulations forms the use case that was chosen for the study. Model exchanges are carried out regularly in order to maintain awareness of network configurations and apparatus effecting the boundary conditions at the edges of utility jurisdiction. A typical data set contains information about connectivity, electrical loads and power injections. Each utility has independently developed its own format for exchanging this data and so an arbitrary number of formats exist including .pdf, MS Excel and laterly, in the case of UK Power Networks, CIM RDF XML files. The National Grid Data

and Analysis team must then laboriously convert these different data formats through a series of processes into a switch level model and disseminate it to the control, planning and network design departments. Such information exchanges enable essential operational activities such as coordinated outage planning, evaluation of fault in-feeds and loads, simulation of short and medium term scenarios and evaluation of planned updates against historical network status. An increase in the frequency of such exchanges of information and data based upon emerging standards will be essential to enable fully interoperable smart grid functionality at both a national and international level.

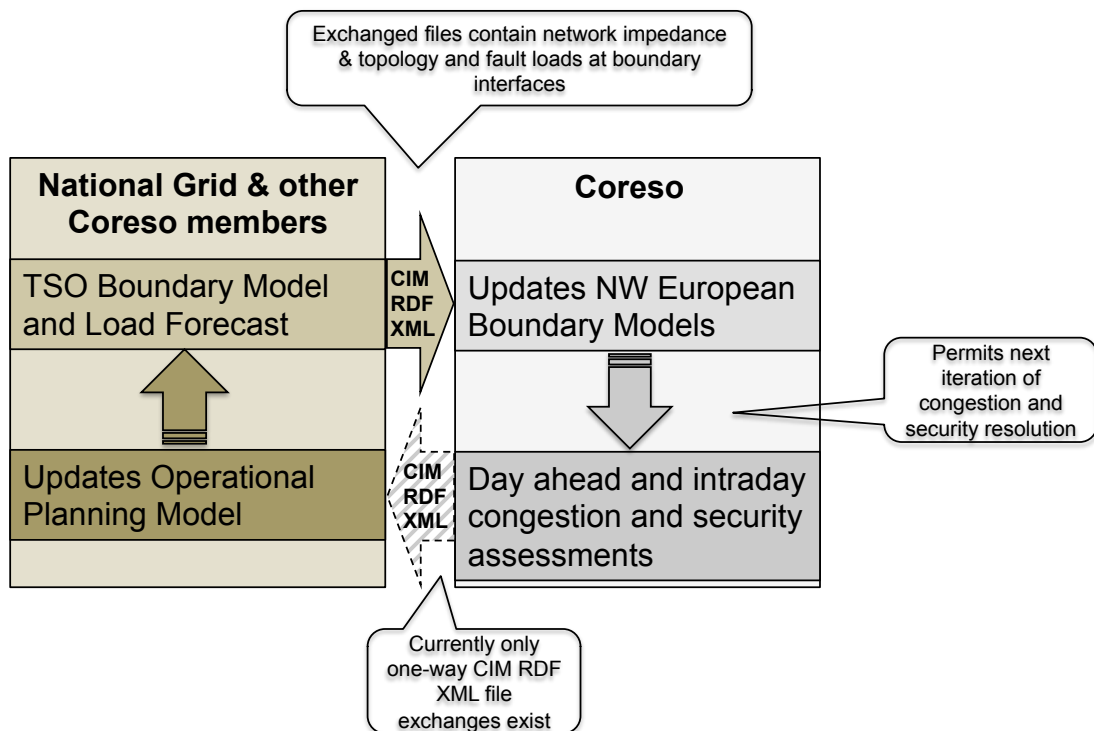

Fig. 22. National Grid to Coreso planning model exchange process.

In Fig. 22. a different use case involving information exchange between Coreso member organisations (50 Hertz, Elia, RTE, Terna and National Grid) was considered. As the Regional Coordination Service Centre for Central and NW European transmission systems, Coreso consumes Day Ahead Congestion Forecasts and SCADA feeds as well as system boundary models from its member TSOs in order to provide an overview of transnational

network boundary conditions and issue network security assessments. At present National Grid are the first member to contribute network boundary models (covering the SE of England to include the grid connections to the BritNed and French interconnectors) in the CIM XML RDF format, generated by its DigSILENT PowerFactory [181] driven OLTA tool. These models are merged into the Coreso model of TSO boundaries in order to generate the required network overview upon which Day-2 congestion and security studies can be conducted. This level of regional coordination is another essential service required by the transnational smart grid to ensure security of supply to millions of consumers. With the expansion of Coreso members and inter-service links with TSC developing, the opportunity to process large amounts of data, often presented in heterogeneous formats once again presents itself.

Comparing these two use cases, a common theme is seen to emerge concerning preparation of data formats into a standard form. We chose to use the CIM RDF XML format and base our study on model exchanges between the UK Power Networks (UKPN) DNO and National Grid because we were given consent to use their network data models. Both utilities also run the DigSILENT PowerFactory tool which has CIM and Siemens standard PSS®E format [182] data model export and import capabilities. In the mTC use case the UKPN network model was exported in CIM RDF XML in order to simulate a 'validation, merge and transformation to a PSS®E format' service in the cloud. This current use case is typical for utilities requiring to exchange network model data that have not yet made arrangements to do so using a common format such as the CIM. Such file exchanges, as has already been mentioned, are currently a statutory requirement under the Grid Code, but are likely to increase in frequency with smart grid development and increasing amounts of VER integration into it.

From a security perspective additional themes emerge common to both use cases. There is a need for different stakeholders (TSOs, DNOs, OFTOs, Coordination Service Centres) to exchange information within a dedicated location with various privileges of access between participants. Protection of the sensitive nature of network information is considered a high priority in the interest of national security. Provenance and ownership of the data models and their versions must be carefully managed in order to produce reliable

aggregated models. It was these issues and that of demonstrating how the model handling and conversion could be achieved in a private community cloud with remote attestation to provenance of the cloud and its services that became the objective for the mTC project (Fig. 23).

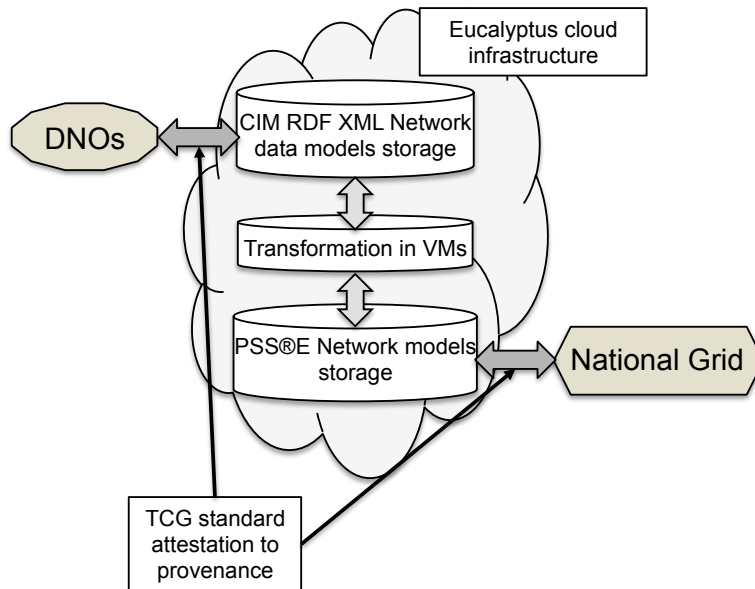

Fig. 23. Overview of mTC project infrastructure.

4.5.2 Provenance of mTC cloud infrastructure and services

Trusted Computing technology has been developed under the promotion of the Trusted Computing Group (TCG) [183] to create a “trusted platform” that is able to check the validity of hardware comprising the platform and the software running on it. A Trusted Platform Module (TPM) enabled device is able to generate and use cryptographic keys that protect the information about the configuration of the hardware and software of a particular device. It creates a “hash-key”, an encrypted block of data representing an input value, that can stand as a summary of the hardware and software configuration of a device. This hash key can then be decoded by an authorised user to remotely attest to the status of a hardware and software configuration in order to determine whether it has been changed. In so doing, the TPM is used to attest to the integrity of the platform in accordance with TCG specifications.

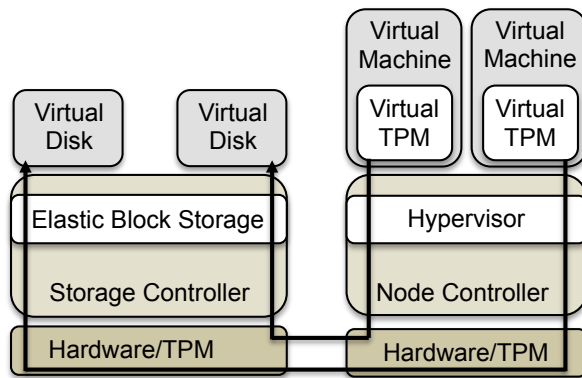

Fig. 24. Logical organisation of mTC services infrastructure.

Eucalyptus is an open source infrastructure for building private and hybrid (with Amazon Web Service collaboration) clouds. In the mTC project, IaaS (Fig. 24) was provided by Eucalyptus and was integrated with the Trusted Computing methodology proposed by the TCG described above. Eucalyptus was also chosen as the web interface for mTC users as it provides the ability for them to remotely attest to the integrity of Virtual Machines (VMs) and the virtual storage they instantiate on the cloud. An important contribution of the mTC project was to demonstrate high levels of attestation to the authenticity of the services provided by the cloud infrastructure before network data model sharing and processing activities took place.

Attestation to the cloud infrastructure is provided cross-sectionally, extending downwards from abstract layers to the hardware layers shown in Fig. 24. At the virtual machine (VM) layer, attestation takes place to check that only expected applications and configuration files are present. Beneath this layer, attestation of node and storage controllers was carried out through trust chains linking VMs and virtual disks to their supporting hardware. In the case of the VMs, the trust chain linked the instantiated VM to the provenance of the hypervisor to attest that the actual VM being used was expected. Proving the hypervisor was genuine included verification of initrd, kernel and root image parameters. The trust chain for the virtual storage is comprised of attestation to the authenticity of the Elastic Block Storage (EBS₁) such that it can only be manipulated by an expected software stack within the Storage Controller supporting it. This ensures that a genuine virtual disk has been loaded by genuine Elastic Block Storage.

The attestation procedure used in the mTC project is known as “deep-quote” [184] and is invoked when a user connects to a VM. It is iterated by a process of looking down the trust chain from the perspective of the VM and its controller. Values generated by the TPM are associated to the VM, Node Controller (NC) and Storage Controller (SC) and combined and held within its Platform Configuration Register (PCR). An attestation ticket is then created composed of the three values signed for by the VM, NC and SC, hashed with a nonce, each at the same time. In this way the cloud user can verify they are using a genuine TPM and secondly attest to the provenance of their VM, its NC and the SC hosting the Elastic Block Storage volumes. This technique has advantages over standard iterative attestation procedures because it limits the required number of iterations to achieve provenance of the cloud to one per VM. Normally the user would require three different attestation sessions referring to each component in the trust chain before the combination of results can form an overall result. This exposes the cloud infrastructure to a wider surface of attack and potentially increases its vulnerability to failure if the results of the client attestations are handled by a single trusted third party. It also makes the infrastructure more difficult to scale as the required number of VMs increases.

Looking further down the mTC trust chain, TPM provenance is enabled from the Built In Operating System (BIOS) that enables measurement of an initial state of the physical system. At the first instance of the boot process a “Core Root of Trust Measurement” (CRTM) is made of the BIOS and PCR located inside the TPM. In this way the TPM itself is anchored to the end of the trust chain provided by the CRTM. Looking up towards the VM, the trust-building process then takes into account the status of the kernel modules, applications and configuration files at boot time. A ‘Trusted GRUB’ is installed to assist in the measurement of the initialisation configuration in the environment of the NC, which includes measurement of the kernel status.

Implementation of iterative attestation builds a trust chain rooted in the BIOS attesting to the provenance of all the software components being loaded. It is composed of three general processes taking into account both client and cloud-infrastructure perspectives. Firstly there is the initialisation phase of attestation as described above. This is then used to record

component measurements for a trust chain out to the NCs and SCs. Then there is the instantiation phase of attestation when a user requires the service of a VM. In the mTC infrastructure, use was made of Open Platform Trust Services (OpenPTS) [185] to store and compare trust measurements to implement VM attestation. The OpenPTS server operates from within the instantiated VM on the client-side and the operating system on the server-side of the infrastructure. From the cloud perspective, on instantiation of the VM by a NC, OpenPTS issues a “TPM_Quote” instruction to the TPM for the measurement values of all the software components of the VM signed by the TPM. These measurement values are checked against the stored measurements inside the client-side OpenPTS server to verify the instantiated VM is genuine.

Having attested to the provenance of the VM, it is necessary to look from the client perspective at the provenance of the NC responsible for instantiating this VM. Iteration of the same process described above but aimed this time at the NC takes place simultaneously, managed by the OpenPTS server, to verify provenance of the NC by the VM. The currency of the measurements used as stored values and quoted values are the cryptographic codes generated by the TPM and stored in PCR. For the SC attestation the same iterative attestation process is applied.

4.5.3 Application of mTC to the use case

The high-level features of the application of the mTC to the use case are depicted in Fig. 23. The use case follows the following steps:

1. DNOs upload and store CIM RDF XML encoded network models into the cloud.
2. National Grid collect, validate and merge these models using the Cimphony application [180] deployed in the cloud by Open Grid Systems Ltd.
3. The merged CIM model is then transformed into a PSS®E data model format for export.

This process demonstrates a typical service that would be required by interoperating power utility model management tools that have yet to exchange network models in the same format. It would also lend itself to reversibility and could form part of a power utility SOA. Fig. 25 is a snapshot of the infrastructure for the DNO file upload and validation stage of the process. ‘Walrus’ is the name of the Eucalyptus storage service. In Fig. 26. a

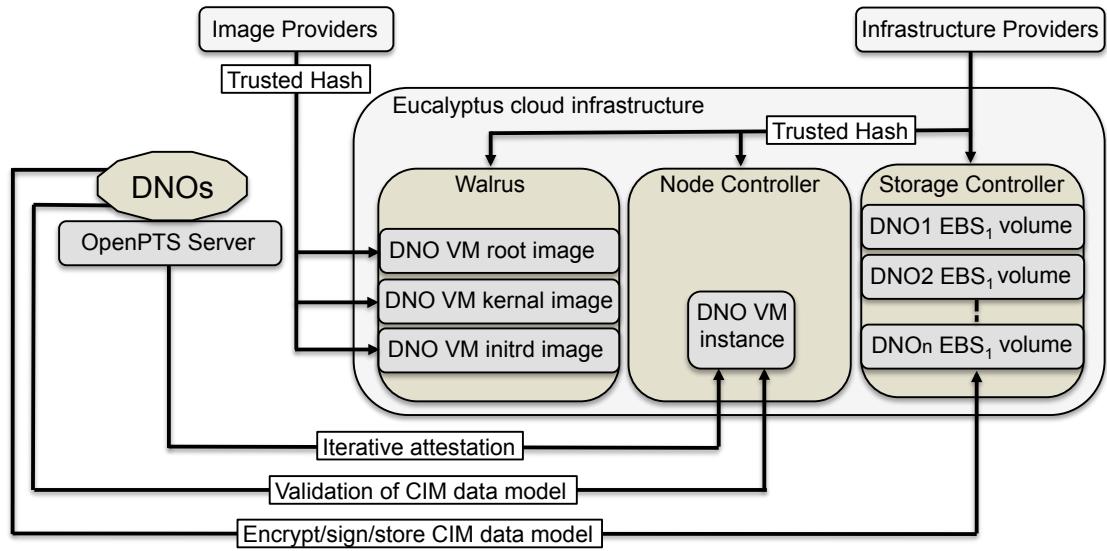

Fig. 25. DNO CIM data model upload to myTrustedCloud.

snapshot of the National Grid receipt, merge and conversion process is shown. Sets of images for the root, image and initrd are required by the Eucalyptus cloud infrastructure to be used by DNOs and National Grid. The Cimphony application is deployed in each root image. In the cloud configurations shown in Figs. 25 & 26, each DNO has read/write access to

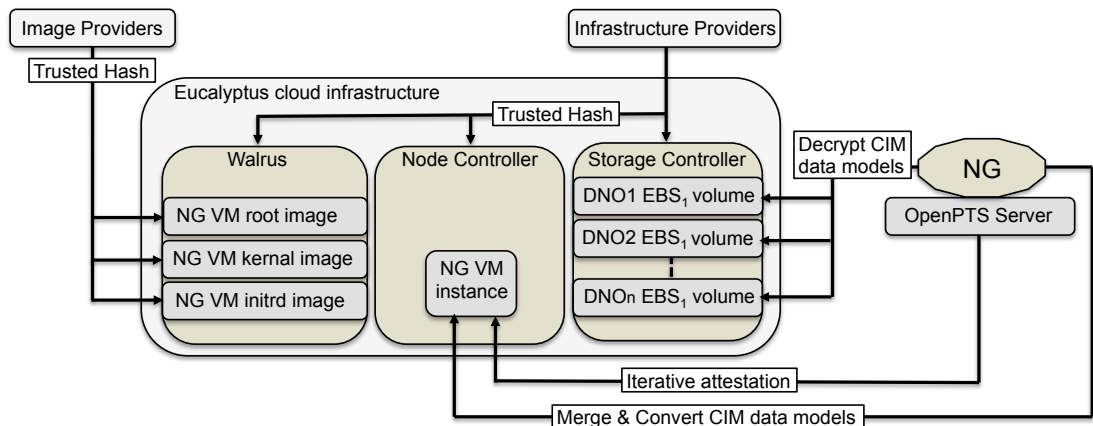

Fig. 26. National Grid CIM data model merge and conversion within myTrustedCloud.

an EBS₁ volume into which it deposits network models. As cloud Administrator, and under agreed privacy arrangements, National Grid has read access to all DNO EBS₁ volumes. This gives it the requisite privilege to merge network models provided by DNOs with its own.

Public and private keys owned and shared between National Grid and the DNOs participating in file sharing enable initial access to their instantiated areas of the cloud. Each participant also has access to the hash values of their respective root, kernel and initrd images which is published, encrypted and signed by the images provider(s). Participants have access to the Eucalyptus SC and NC controller hash values that are issued by the Eucalyptus distribution authority. As the Eucalyptus infrastructure is integrated with the Trusted Computing technology, the DNOs and National Grid can verify the provenance of their VMs and kernels, the Cimphony application and all other software within their VM, NC or SC, by interrogating their OpenPTS servers.

When a DNO wishes to upload a CIM network model to the cloud a VM is instantiated from a root image stored within the Walrus storage service. Verification of the VM, NC and SC follows by means of quotation and comparison of stored measurements handled by the OpenPTS server (as described above) before the network model can be uploaded. In Fig. 27. a detailed Trusted Validation Log generated by the Eucalyptus infrastructure hosted at the Oxford e-Research Centre, reports on the provenance process to instantiate a VM. The critical steps in the iterative attestation process for the SC and NC hosting a VM are described below according to the annotations on Fig. 27.

1. Attestation of the Storage Controller initiated by request to mount a VM triggers the need to attest the VM is binding to the expected virtual storage. The OpenPTS client patched into the VM requests a quote for PCR values generated by the SC (virtual) vTPM and reports these to the Open PTS server for comparison with those held in its Stored Measurement Logs (SMLs).
2. Verification of the connection between the SC and the NC hosting the VM follows to attest that the VM is hosted by the expected NC.

- Verification of the NC hosting the VM then follows with a further iteration of comparisons between recorded PCR values in the OpenPTS server SMLs and values generated on request by the OpenPTS client of the NC.

Each level of attestation conforms to the 'deep-quote' procedure described above in 4.5.2 as it builds the trust chain.

```

Trusted Validation Log
Detailed output of Trusted Cloud Validation

1 Connecting to SC
Target      : mytrustedcloud.oerc.ox.ac.uk
Collector UUID : 86c9fc86-e44c-11e0-bfec-003048b2e478
Manifest UUID : 8a46a468-e44c-11e0-bfec-003048b2e478
manifest[0]   : /home/ubuntu/.openpts/86c9fc86-e44c-11e0-bfec-003048b2e478//8a46a468-e44c-11e0-bfec-003048b2e478/rm0.xml
manifest[1]   : /home/ubuntu/.openpts/86c9fc86-e44c-11e0-bfec-003048b2e478//8a46a468-e44c-11e0-bfec-003048b2e478/rm1.xml
configuration : /home/ubuntu/.openpts/86c9fc86-e44c-11e0-bfec-003048b2e478/target.conf
validation policy : /home/ubuntu/.openpts/86c9fc86-e44c-11e0-bfec-003048b2e478/policy.conf
validation policy : /home/ubuntu/.openpts/86c9fc86-e44c-11e0-bfec-003048b2e478/policy.conf
aide database  : (null)
aide ignore list : (null)

2 Verifying SC
Connecting to NC:
10.141.4.11 Target      : 10.141.4.11
Collector UUID : baccfb4a-e006-11e0-899f-003048b2eb86
Manifest UUID : ab4c05c2-e44c-11e0-899f-003048b2eb86
manifest[0]   : /home/ptsc/.openpts/baccfb4a-e006-11e0-899f-003048b2eb86//ab4c05c2-e44c-11e0-899f-003048b2eb86/rm0.xml
manifest[1]   : /home/ptsc/.openpts/baccfb4a-e006-11e0-899f-003048b2eb86//ab4c05c2-e44c-11e0-899f-003048b2eb86/rm1.xml
configuration : /home/ptsc/.openpts/baccfb4a-e006-11e0-899f-003048b2eb86/target.conf
validation policy : /home/ptsc/.openpts/baccfb4a-e006-11e0-899f-003048b2eb86/policy.conf
validation policy : /home/ptsc/.openpts/baccfb4a-e006-11e0-899f-003048b2eb86/policy.conf
aide database  : (null)
aide ignore list : (null)

3 Verifying NC
Target      : 10.141.4.11
Collector UUID : baccfb4a-e006-11e0-899f-003048b2eb86 (date: 2011-09-16-01:53:52)
Manifest UUID : ab4c05c2-e44c-11e0-899f-003048b2eb86 (date: 2011-09-21-12:24:36)
key(ssh)    : default
username(ssh) : default
port(ssh)   : default
policy file  : /home/ptsc/.openpts/baccfb4a-e006-11e0-899f-003048b2eb86/policy.conf
property file : /home/ptsc/.openpts/baccfb4a-e006-11e0-899f-003048b2eb86/vr.properties
integrity    : valid
EOF
Target      : mytrustedcloud.oerc.ox.ac.uk
Collector UUID : 86c9fc86-e44c-11e0-bfec-003048b2e478 (date: 2011-09-21-12:23:35)
Manifest UUID : 8a46a468-e44c-11e0-bfec-003048b2e478 (date: 2011-09-21-12:23:40)
key(ssh)    : default
username(ssh) : default
port(ssh)   : default
policy file  : /home/ubuntu/.openpts/86c9fc86-e44c-11e0-bfec-003048b2e478/policy.conf
property file : /home/ubuntu/.openpts/86c9fc86-e44c-11e0-bfec-003048b2e478/vr.properties
integrity    : valid
Target      : localhost
Collector UUID : e0a0a52e-e461-11e0-b81d-525400123456 (date: 2011-09-21-14:56:25)
Manifest UUID : 892e30f6-e455-11e0-b81d-525400123456 (date: 2011-09-21-13:28:04)
key(ssh)    : default
username(ssh) : default
port(ssh)   : default
policy file  : /home/ubuntu/.openpts/e0a0a52e-e461-11e0-b81d-525400123456/policy.conf
property file : /home/ubuntu/.openpts/e0a0a52e-e461-11e0-b81d-525400123456/vr.properties
integrity    : valid
  
```

Fig. 27. Validation log from Eucalyptus on VM instantiation.

Once the network model is then uploaded it is validated by use of the Cimphony application which is running within the instantiated VM. The ENTSOE profile was used in our demonstration as the standard against which the uploaded network model was validated (Fig. 28).

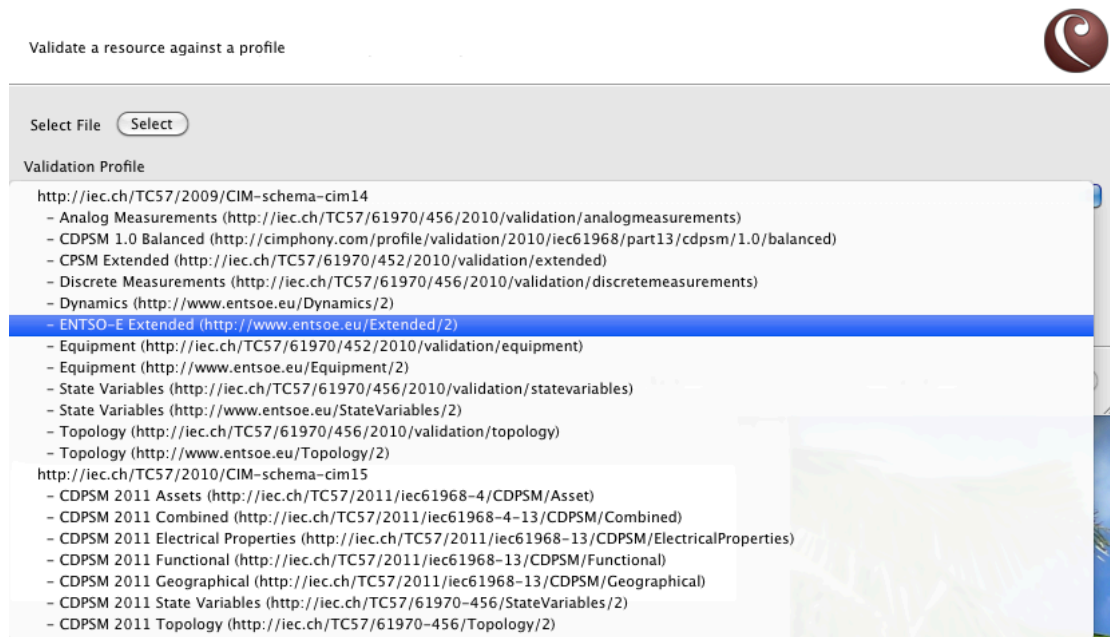

Fig. 28. Selection of the validation profile from within Cimphony.

It should be noted that Cimphony is a product designed by Open Grid Systems Ltd. to display, validate, build and analyse the components of electrical power network models derived from PSAs. It can handle the transformation between a variety of common file formats although it's principal file handling capabilities are designed for the IEC CIM. Normally used as a standalone application, for the purpose of the mTC project a part of Cimphony's functionality was customised to be suitable for deployment in a cloud infrastructure. These parts still possessed user interfaces as shown in Fig. 28 and Fig. 29.

After completion of the validation of the DNO model it was encrypted and signed with the National Grid public key and the DNO private key, then stored in an EBS₁ volume tagged to the current VM with a name/time/date stamp. At the end of this process the VM was destroyed. To access and read this encrypted model file the National Grid user begins by instantiating a VM in a similar way to the DNO described above. Then each DNO EBS₁ volume

is mounted and decrypted with verification of the signature and the age of the time stamp. The merging of the CIM files then takes place followed by the transformation of the merged file into the PSS@E format using the Cimphony application. In Fig. 29, a decomposition of the merged network model into its constituent network resources is shown as the transformation is completed within Cimphony. It can then be downloaded or placed in storage in the cloud with the same identity tagging process as previously mentioned. The VM is then destroyed.

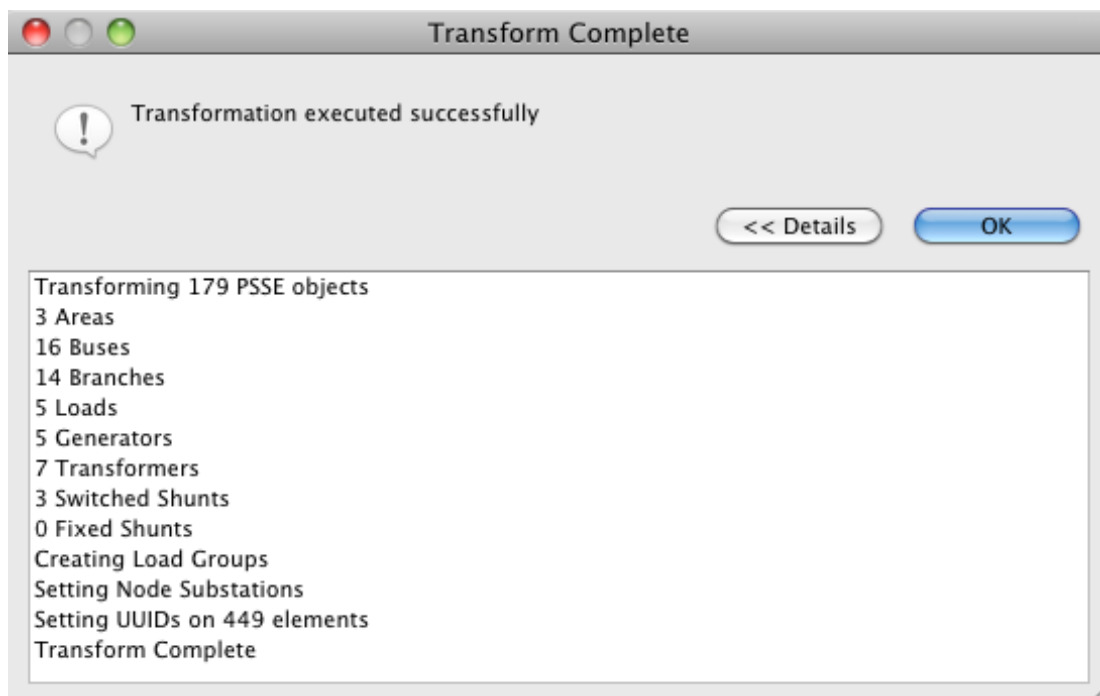

Fig. 29. Validation report from Cimphony after execution of CIM file transformation.

4.5.4 Analysis of performance, threats and vulnerabilities

The mTC project focussed on demonstrating a relatively small but crucial section of the overall workflow involving the use and handling of network data models shared from enterprise to enterprise. It focusses on this task in view of the coming need to exchange and process modelled information between multiple utilities in far great amounts and frequencies than has hitherto been necessary. The demonstration hardware was based on an Intel Quad Core i5 PC with a TPM module built into the motherboard running Ubuntu 11.04 as operating system and 16Gb of RAM. We found that building the trust chain of the NC and SC including bootstrapping took about three times longer than

booting an untrusted counterpart machine, at approximately 3 minutes. The delay in verifying the trusted VM from instantiation is roughly the same as in an untrusted cloud at approximately 1 minute. These times are based on the use of a test machine equipped with an Intel i5-2400 Quad core processor with 16Gb of RAM and a TPM module integrated into the motherboard running Ubuntu 11.04. In operational terms, these time delays are negligible and would be subject to a planned procedure where scheduled machine reboots are concerned to minimise workflow disruption.

The mTC project proved that a remote cloud user could attest to the authenticity of a VM and thus be protected against the insertion of rogue analysis code into the workflow. However broadening the circle of trust to include the potential for stolen identities of permitted users would require further measures to link user attestations to a known set of platforms, a solution known as 'property-based attestation' [186]. Protecting privacy of exchanged data in this way by limiting access to the cloud to only permitted platforms would require a trusted third party to manage mappings to all the software components used within the cloud infrastructure. Clouds are vulnerable to malicious code being injected into memory during runtime attacks such as stack-overflows. The implementation of Dynamic Root of Trust for Measurement (DRTM) can be used against this kind of threat as it measures the runtime chain of trust for critical applications but modification to the cloud software stack should be considered to make this approach production-ready.

4.6 Further work

As the use of open standards in managing information exchanges between smart grid companies develops the scope for trusted cloud platforms to support data processing as well as interoperability requirements is very promising. The TSC common IT platform for data exchange and n-1 security assessment already resembles this model of operation. At National Grid the number of network studies to prepare the system for risk-constrained, cost-optimised operation within an approved operational envelope as real time approaches is already approaching 100 within the day -1 time frame (Fig. 19). There will also be requirements to present complex arrangements of shared

information in decision-support visualisations that enhances situational awareness and enables control room engineers to ‘fly the grid’. Much of this information and the data processing requirements behind it will be required by utility companies cooperating and participating in smart grid operation. Further work beyond the mTC project could therefore consider the use of trusted cloud infrastructure to support both the information exchange and data processing elements that are found duplicated in different utility workflows.

The Grid-user data service was proposed to National Grid by the Author as an extension of the Information Management Framework described in Chapter 3 and is now being investigated as a scalable means to manage the sharing of information between GB system utilities (Fig. 30.) It could be the first step towards realising the use of trusted cloud infrastructure in the UK in this way with IaaS provided by a National Grid approved business partner (such as Wipro). A future phase of development could see the sharing of applications deployed in the cloud addressing common data processing requirements. These need not necessarily be limited to the transformation of different data formats and schemas but could follow an emerging model to manage application suites in the cloud by their vendors with operational access granted to privileged users. In this way it is conceivable that the SOA

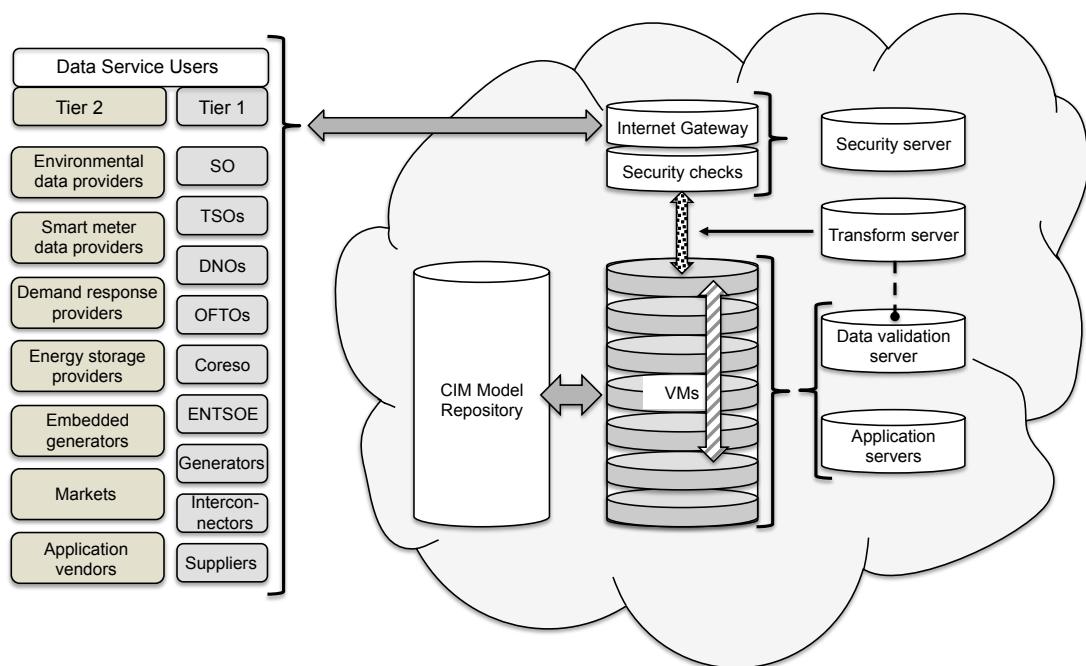

Fig. 30. Grid-user data service.

described above (Fig. 14) could eventually be deployed within trusted cloud infrastructure and be realised as a scalable solution to the very large scale information integration and data processing requirements of the smart grid (Fig. 15). Such a vision would include trusted third parties in the provision of services including data transformation and processing as well as managing the access privileges and privacy arrangements between cloud users. Read and write privileges to the CIM model repository in which the shared data would be collated would depend on commercial and regulatory agreements already in place.

The inclusion of a CIM model repository which was able to merge and align network data models from different network operators would form the basis of a system-wide NMMS. This reflects the previously described SOA for very large scale integration. The creation and demonstration of a CIM network metamodel repository at National Grid will be discussed in the following Section.

4.7 Chapter summary

This Chapter began by describing the stochastic nature of the emerging smart grid and some of the key challenges facing National Grid as more environmentally-dependent technologies are integrated into it. The new paradigm for preparing the grid for risk-constrained, price optimised operation requires many more network planning studies and a wider quantity of data to be shared and processed before real time. It was proposed that such a paradigm matches the elastic scalability and metered cost of the emerging cloud computing paradigm, although such a model had not previously been applied to the critical infrastructure of electrical power system operation due to security and privacy concerns. Cloud computing models and the issue of cloud computing security was then discussed before presentation of the myTrustedCloud project. It was stated that the existing availability of cloud computing facilities, even those of high order service levels are currently inadequate to meet the stringent requirements for managing critical national infrastructure, which includes the electrical power system.

Addressing this concern, the mTC project developed and demonstrated a prototype trusted cloud infrastructure based on the integration of trusted computing components to deliver a viable solution to the high security requirements of the electrical power system community. The principal contribution was to demonstrate how provenance of software and hardware components could be remotely attested under a realistic data use case application. The publicly available Eucalyptus platform was used to support the deployment of data file format conversion and validation software without the need for modification, which therefore lends itself to deployment in other open source platforms as a consequence. This project demonstrated a number of novel concepts, including:

- First time demonstration of a practical application for data model merging, validation and transformation within a secure cloud infrastructure that would meet a familiar utility interoperability requirement
- Use of a publicly available infrastructure solution without the need for software modification to meet the high data integrity requirements of the power industry
- Demonstration of remote attestation to cloud provenance (infrastructure and applications) by utilities with requisite privileges
- Chain of trust provenance demonstrated from VM level down to sub-kernal level of hardware
- Privacy of data protected by property-based attestation and trusted computing technology

This project stands as an example of how, with further development an industrial solution may be developed to manage smart grid secure data exchange and processing requirements.

CHAPTER 5

A METAMODEL REPOSITORY FOR USE WITH THE IEC CIM

5.1 Introduction

This Chapter will present a methodology for managing smart grid data through greater exploitation of the CIM XML and RDF as ‘technologies’ than has hitherto been reported in this context [127,187]. A standard OMG modelling hierarchy will be used to explain the context in which the IEC CIM operates in support of information organisation into knowledge representation. The vexing issue of power system resource identification encountered when combining different PSA CIM RDF XML representations of the same network reality, will be addressed as part of a novel design methodology for a metamodel repository that could form the heart of a NMMS and utility operational business intelligence resource. Demonstration of this repository and the crucial issue of management of model variation through time will then also be reported on.

5.2 Data, information, knowledge and intelligence

“By understanding the basic rules of syntax and validation, one gains an understanding of how data is typically packaged and processed in IT systems and how XML can be used as a tool for computer-to-computer communications. By understanding the complex social and psychological spaces through which meaning is negotiated in rhetoric, one becomes aware of the limitations of purely data-driven approaches and of the complexities involved in the relationships between data, information, knowledge, and cognition.” [188]

In this Chapter we shall address the proposition that data, like sand, is amorphous and unrelated. As McDonald says in a recent issue of ‘Electricity Today’, “...’data’ comes from the field, but has no value until processing turns it into ‘information’, which is further processed into ‘business intelligence’” [189]. A similar sentiment in respect of the “data into knowledge into action”

paradigm has been expressed by Bryant *et al* [190]. The smart grid requires knowledge, not just more data, to be managed intelligently before its full potential can be unlocked [119]. Data organised syntactically and semantically fuses into ‘building blocks’ of information that when put together coherently supports knowledge. This process requires metadata and context (namespace) for the coherent organisation of information models as the ‘glue’ that leverages the value of data. We can say therefore that the semantic richness of CIM classes to model information, their organisation defined by schemas to provide meaning and the context of an XML namespace, gives rise to KR.

The mounting ‘deluge’ of data will challenge utilities unless they model it, first into information and then knowledge to support the intelligent management of the smart grid. In Fig. 31 this process of leveraging the value of data is outlined and aligns with the well-known “Value Chain” popularized by Porter [191]. At each stage of ascent, value is added to the preceding

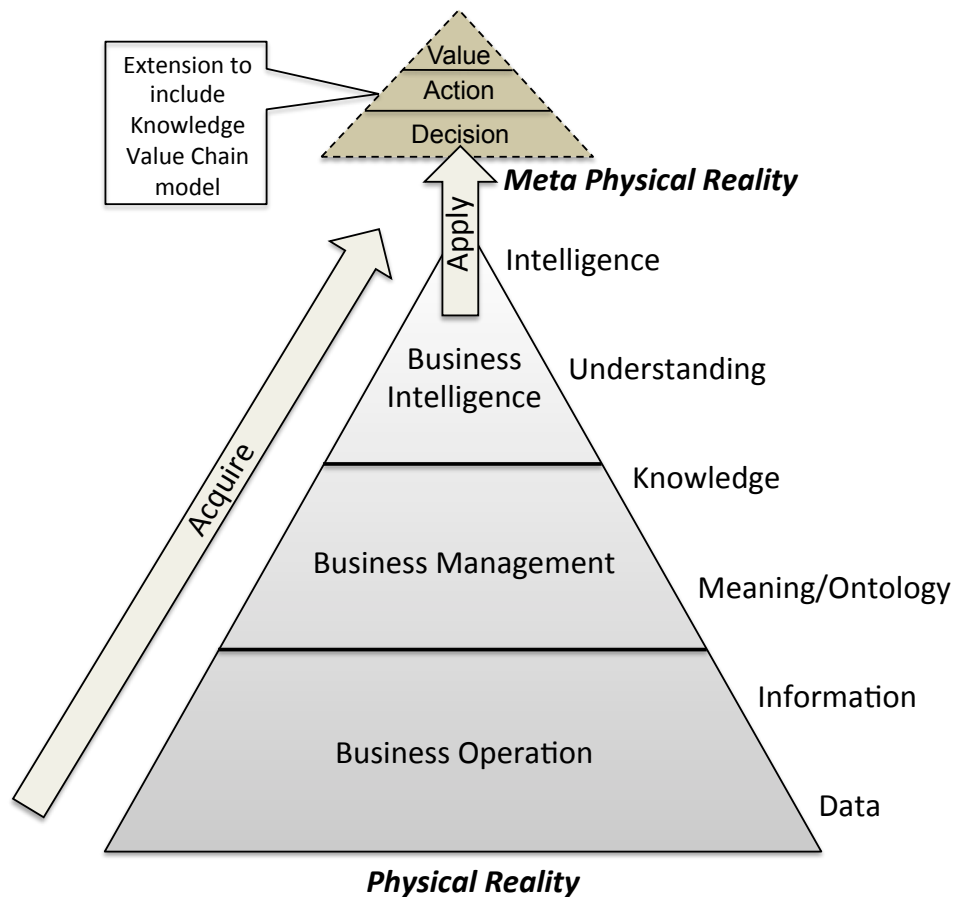

Fig. 31. The ascent of data in support of business intelligence and decision making.

'commodity'. The diagram expresses the heightened conceptual nature of intelligence in contrast to the physical reality from which data arises and the synthetic 'metaphysical reality' in which decisions are made. The extension shown in Fig. 31 to include the 'Knowledge Value Chain' highlights the two major stages of *knowledge acquisition* and *knowledge application* [192]. It emphasises the importance of quality in the acquisition phase in influencing the decisions and actions taken in the application phase. A shared understanding between the parties involved in acquisition and application is also crucial according to Powell [192] and relates in the power system context to the need for ontology, as referred to in Section 2.6. This principle can easily be observed within the control centre of the electric power utility and underlines the need for situational awareness to accurately convey network reality.

In contrast to 'big data analytics' [193] that seek patterns in the 'sands of data', the proposed approach adds the dimension of metadata from the use of metamodels such as the IEC CIM to create a pathway to intelligence. This is an important distinction because as has been stated, the efficient and reliable operation of the smart grid depends on the quality of information feeding into business intelligence as well as to meet the rigour required to interoperate PSAs. Modelling data using the CIM validates its quality in the process of raising its value to support reliable business intelligence and reduce the uncertainty of data *veracity* [193]. This two-way benefit to both business intelligence and interoperability from the deployment of information models therefore supports organisations in achieving a competitive edge in a sea of data. To the power utility it could also result in the safer and more reliable operation of the smart grid.

5.3 Placing the CIM in a knowledge framework context

In [194] Ogden and Richards' described a *meaning triangle* in which they showed a 'Concept or Thought' as an *abstraction* of a real 'Thing', and a 'Symbol' as a *representation* of the 'Concept/Thought' as well as *standing for* the 'Thing' (Fig. 32a). In [195], Henderson-Sellers has applied this approach to modelling and re-named the principal components. 'Thing' as the 'System Under Study' or SUS, 'Symbol' as the 'Communicated Model' and 'Concept' as 'Cognitive model' (Fig. 32b). Following this approach Henderson-Sellers states that the role of the model is to represent the SUS and the SUS to interpret the model.

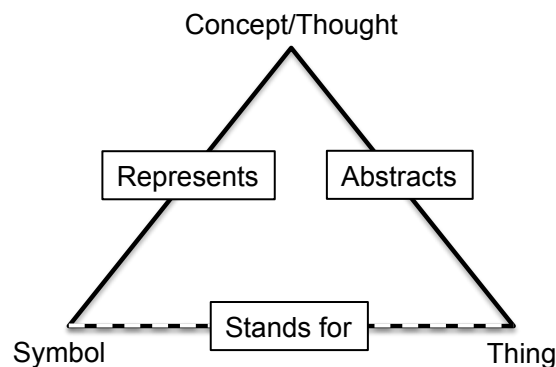

Fig. 32a. Ogden and Richards' "Meaning Triangle". As seen in [195].

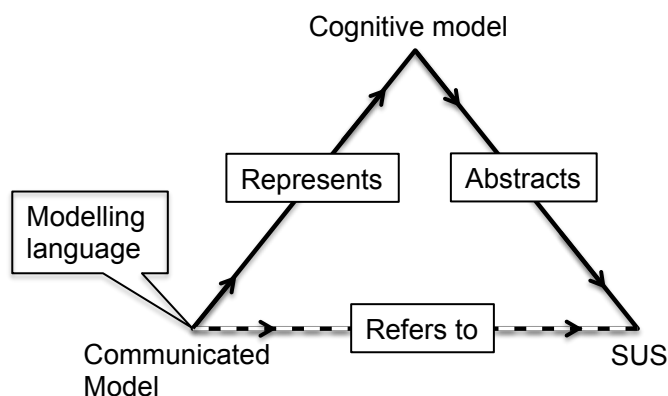

Fig. 32b. Ogden and Richards' "Meaning Triangle" applied to modelling. As seen in [195].

In [196] the Author has adopted this useful approach as a proposed framework to underpin understanding of the use of models within an electrical power system context (Fig. 33). In this way the CIM RDF XML model created by the CIM adaptor of a power system application can be seen as being *representative* of its proprietary PSA data model. It is the 'Communicated Model' in the interoperability use case.

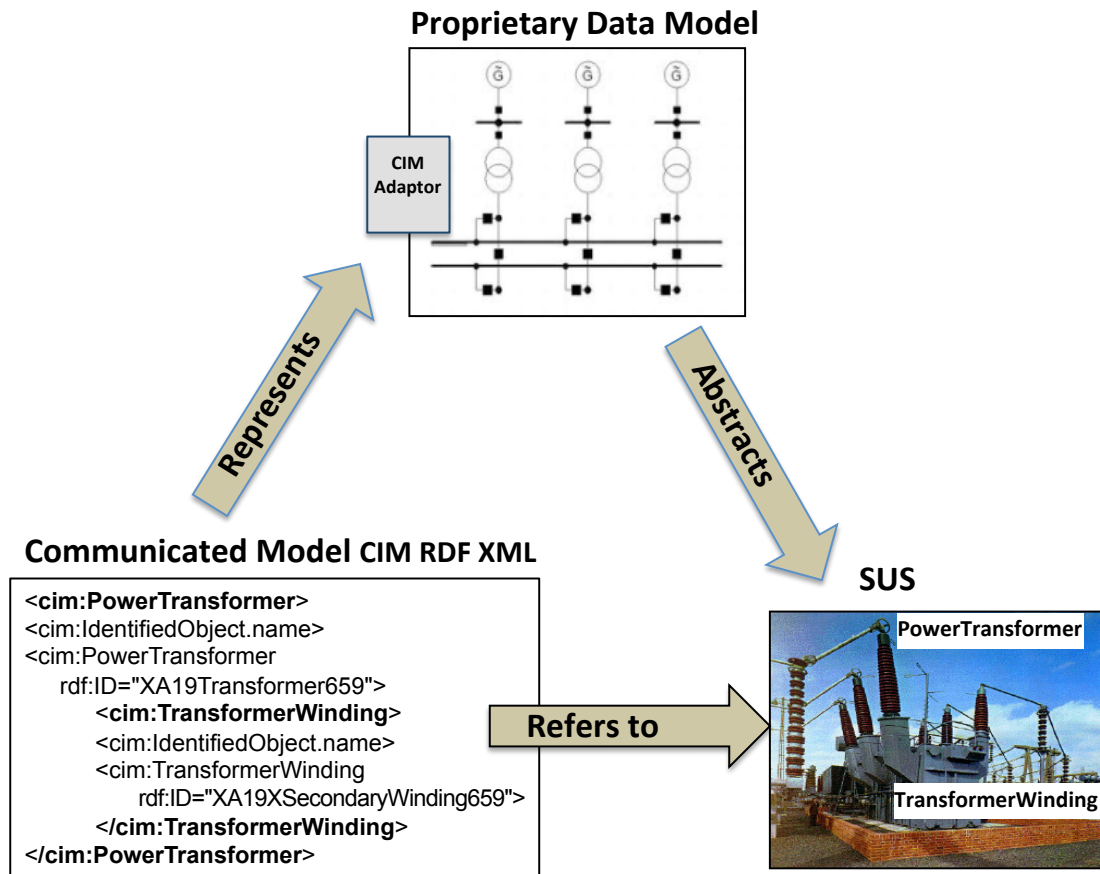

Fig. 33. Application of the Meaning Triangle to a power system model context.

In order to support a coherent representation of network reality, it *refers to* the network being modelled (SUS). From the point of view of the PSA, each *data model* serving its internal functionality is a proprietary representation, or *abstraction*, of the reality of the power system network being modelled (SUS).

In Fig. 34, after Henderson-Sellers and Unhelkar in [197], this framework of relationships is extended to place the CIM and PSA data model in the standardised modelling context of the four-layer hierarchy belonging to the Object Management Group (OMG). The four levels of the hierarchy conforming to the OMG specification are shown in grey check. By superimposing the principles behind the triangle of relationships described in Fig. 33 on each level, we can see that each instance at a higher level represents an abstraction of the level below. With respect to the relationship between the reality of the SUS (transformers, lines substation, etc.) and M0,

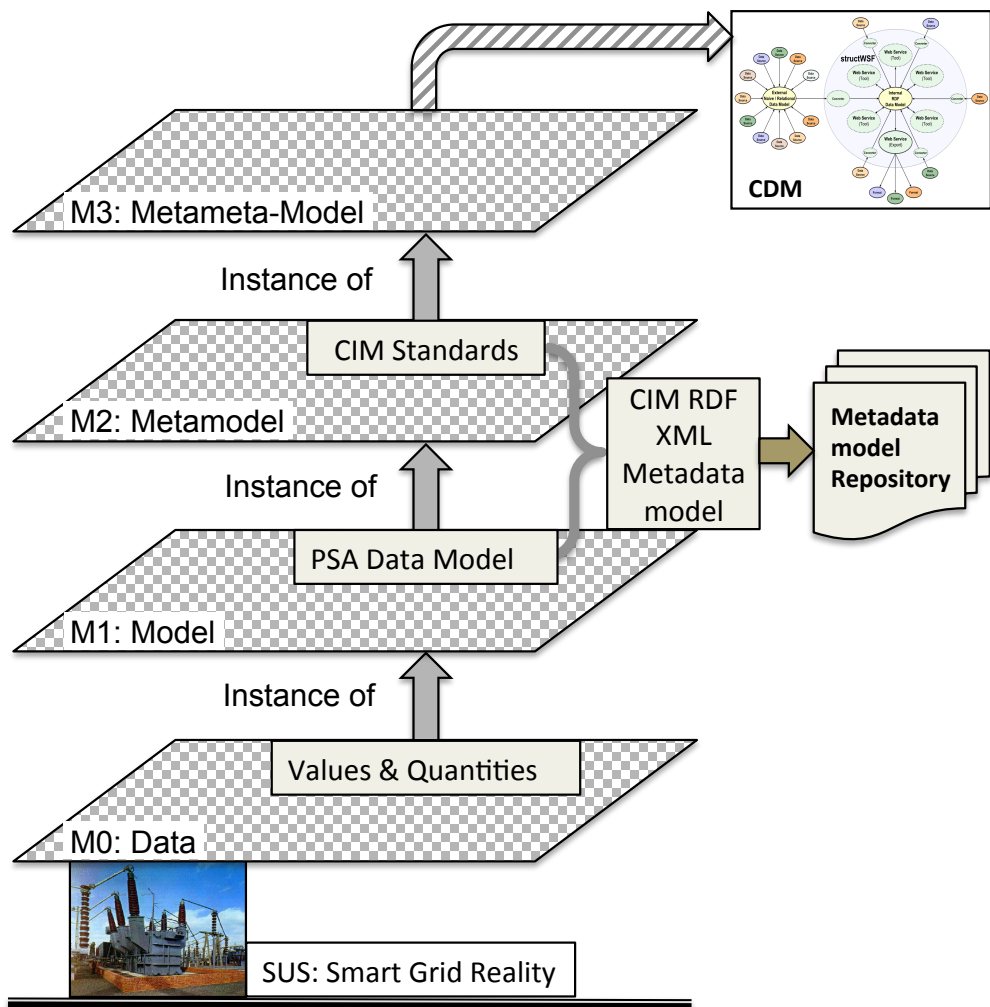

Fig. 34. Application of the OMG 'Four-layer Hierarchy' to a power system model context.

it is possible to interpret this part of the framework in Aristotelian terms, where in order for a property to exist (in this case data in the form of values and quantities) it is necessary for it to be 'had' by an object – such as the transformer in the SUS shown. Thus it is arguable that the data of M0 is instantiated as a consequence of the existence of the transformer. Our focus however, is on placing the IEC CIM standards within the context of the four levels of the accepted OMG hierarchy because we are concerned with an instantiation process that begins with the existence of data in M0.

From here it is possible to locate the proprietary data model used by the PSA at M1. This is because each PSA data model is created by instances of electrical power network components within the SUS and their properties of values and measurements. As such, it is an abstraction of the real system under study. The IEC CIM as a set of power system standard reference

models, are composed of 'UML type classes' that are abstract forms of objects used as the components making up electrical power network data models. They support the representation of objects found on M1 using the form of the RDF triple notation introduced in Section 2.4. and elaborated-upon in Section 2.6. Thus the PSA data model objects become mapped to the CIM RDF XML files in the transformation process taking-place within a PSA CIM adaptor according to the schema of the CIM profile being used. The CIM metadata model, as a representation of the PSA data model, is then used as the Communicated Model so that other PSAs equipped with CIM functionality can interpret it back into their data model format using a reversed transformation process.

Only objects found within the data model on M1 are instantiated into the metadata model. Thus if the CIM reference metamodel occupies the level of M2, the CIM metadata model is shown in Fig. 34 to be between levels M1 and M2 as it is a product of their interaction. It is formed out of a combination of processes that *represent* the CIM metamodel standard and *refer to* the instantiated data model. It is these Communicated Models that contain information about the SUS that are combined in the proposed metadata repository to consolidate and concentrate our knowledge of the SUS and support its further understanding (Fig. 31). This extends the application of the IEC CIM to knowledge representation (KR) first mentioned in [70].

In the repository, metadata models are consolidated into a semantically aligned representation of network reality. As more models are added to the repository the granularity of this composite conceptualisation increases, improving our knowledge of the real SUS. In a business where the existence of heterogeneous data model formats are prevalent, consolidation can only become possible at the metamodel level of abstraction and in the domain of power systems is dependent upon the CIM standards. However, this design for a metadata model repository may not be limited only to power systems but could be adapted to other domains where multiple representations of a shared reality in heterogeneous formats make up its understanding.

In [154] Hargreaves *et al* discuss the concept of a 'shared company data model' which is derived from a combination PSA metadata models driven by the commercial, functional and asset processes within National Grid (Fig. 35).

This paper raised the issue of how data ownership relates to its identity, which is a critical challenge to creating a composite knowledge resource as well as to interoperability. It will be discussed further in the next Section as background to the rationale for the proposed novel CIM repository methodology. The OMG hierarchy shown in Fig. 34 extends to a higher level of abstraction, M3. We may use this to indicate the level at which the merged metadata models of M2 held within a repository could become instances of a corporate metameta data model (CDM). Exploiting this capability was not the concern of this research but it suggests a further use case for the metadata model repository as a knowledge resource, contributing to enterprise business analytical processes using abstracted business knowledge at this level.

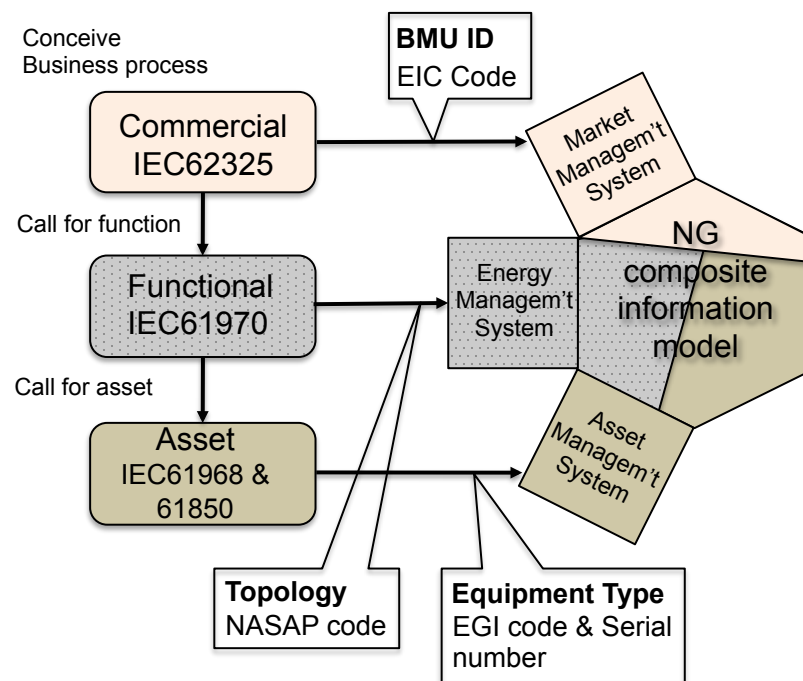

Fig. 35. Conceptualisation of composite data model with data ownership pattern.

5.4 Data ambiguities and collisions

Data ambiguities are concerned with confusion over names and identities, meanings and contexts. The question of persistence of universally unique identifiers (UUIDs) is connected to the one of data ownership, introduced in the previous section and relates directly to the degree of interoperability attainable. In normal practice within a large, multi-departmental electrical power utility a global UUID is not attributed to a network resource at its inception to stay attached as a universal ID throughout its lifecycle. For example, Fig. 35 shows how different stages of a resource lifecycle are marked by the tags of heterogeneous codes acting as IDs. From its inception due to a market requirement to report on a utility function, to it entering registration within the asset database, the asset is given new or additional names and identities. As autonomous model authorities, different PSAs apply 'local' IDs not designed to promote wide-ranging interoperability. However, interoperability is dependent on, and proportionate with, the degree of resource ID uniqueness and persistence within a given context.

The issue of different names that are used as human-readable identities and sometimes also to form machine readable IDs also confuses semantics. As such, knowledge representations of common network resources vary with the perspective of the PSA as well as the variation of names and identities attributed to a common resource. Notwithstanding the designed-in 'structural' differences between models (such as in the differences in detail and arrangement of a connectivity model compared to a topology model) we can start to see how diversity enters representations of a singular network reality. Add to this the opportunity for resource parameter errors to be made from multiple points of data entry and the objective of a single version of network 'truth' seems even harder to achieve.

5.4.1 Naming and identity ambiguity

The issue of how information infrastructures at system interfaces manage cross-boundary naming remains non-standardised. The establishment of a model Naming Authority must pay regard to the persistence of IDs as well as their visibility within the overall data model. For example, some EMS systems may re-use resource IDs after an asset has

been deleted or modified within a network. As multiple systems contribute to a company data model a hierarchical Naming Authority could be implemented based on data ownership to control the application of the master identity. This suggests the need for a higher-level solution to oversee model management than may be possible from within a CIM translation interface at PSA level.

Such an approach could use a 'centralised' Object Naming Authority and Registry that maintains the persistence of resource IDs, as reported on in [154] (Fig. 36). One advantage of this approach, which resembles the *Authoritative name server* hierarchy deployed in the World Wide Web, Domain Name Server (DNS) architecture, would be that it has full data vision across multiple systems and may be easier to update than multiple individual translation interfaces, with partial data vision, situated at a lower-level perspective.

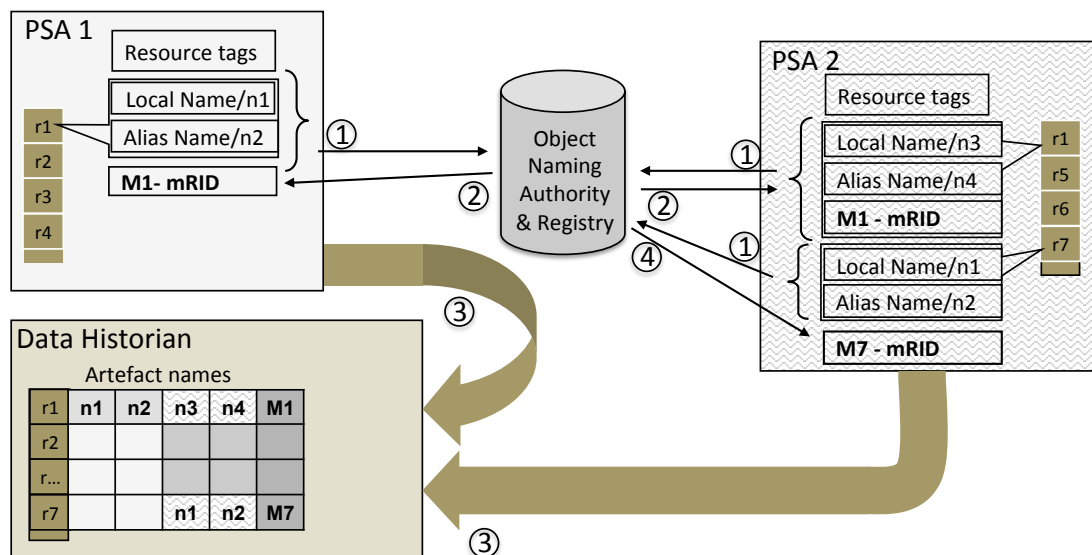

(1) - PSAs interrogate the Naming Authority for record of an mRID associated with resource objects (n1..n4) within their internal models. (2)- If an mRID exists on record {a1}, this is applied to local data ID's before, (3) model export to Data Historian. (4) - If no record exists (PSA 2/n1, n2) then a new mRID {a7} is generated and applied to model resource object before storage in Data Historian.

Fig. 36. Conceptual model naming management infrastructure.

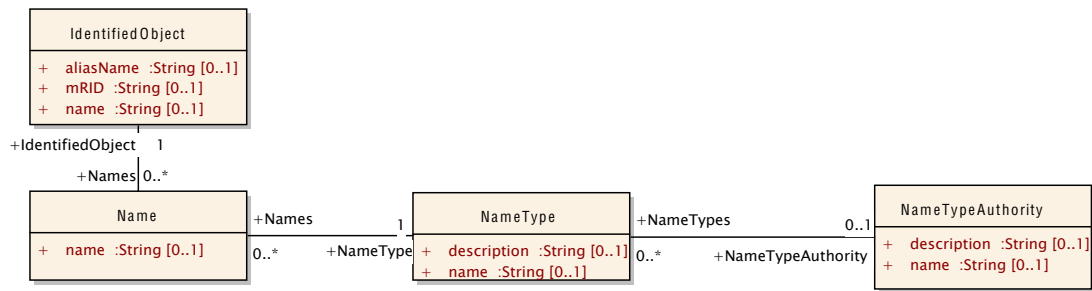

Fig. 37. UML naming architecture within IEC CIM 15.

A recent release of the IEC CIM (CIM 15) [26] attempts to address the problems of multiple names and identities derived from different sources by providing UML classes to accommodate these multiple representations (Fig. 37). The “IdentifiedObject” class captures the instantiated mRID and accommodates an alias and a name for the resource as well. If additional names for this resource are known to exist then they are instantiated in the “CIM:Name” class through a 1:n association. If further information about these additional names is also known then two other classes associated to the “CIM:Name” class are available to accommodate the type of name (“CIM:NameType” and the naming authority (“CIM:NameTypeAuthority”). Table 2 below, describes the CIM architecture of Fig. 37 in more detail.

Table 2. CIM 15 naming architecture with brief description

Class	Attribute	Description
IdentifiedObject		The root class providing identification for classes needing identification and naming.
	aliasName	An alternative to the “.name” attribute.
	mRID	A globally unique Master Resource ID issued by a Model Authority usually derived from the rdf:ID created in the CIM adaptor.
	name	A human readable name which may be non-unique.
Name		Provides the means to define any number of human-readable names for the object.
	name	Any free text that names the object
NameType		Type of name relating to the possible ‘local system name’ for the object
	description	Description of the name type.
	name	Name of the name type.
NameTypeAuthority		Authority responsible for creation and management of names of a given type.
	description	description of the name type authority.
	name	name of the name type authority.

The method proposed in [154] relied upon a centralised supervisory mechanism to have the authority to issue a unique mRID where common power system resources were presented to the Object Naming Authority and Registry with multiple 'local' names and identities. In this way these common resources would be aligned within the overlapping parts of shared models by their unique mRIDs. However, the need to maintain an increasingly complex centralised register comprising multi-lateral tables reflecting 1:n relationships between mRID and PSA-derived IDs is deemed impracticable. This is because it would require time-consuming regular maintenance as network reality changed and potentially slow model transit times (due to the need to refer to look-up tables) in interoperating with the data warehouse or historian. As resource *names* are allocated by some PSAs to act in place of an rdf:ID, this could also add to the ambiguity of the identity of the resource, increasing time penalties for model processing.

In [187] Hargreaves *et al* raised the concern that the CIM 15 "IdentifiedObject" naming architecture could increase the import/export and validation process time of large CIM models by the order of 50-100%. Given that full TSO network models are the order of 1 to 2 million objects and can currently take several hours to be processed by an EMS CIM adaptor, further time penalties are not welcome. The reason for the extra time required to process these models is because each "IdentifiedObject" would have on average between 5 and 12 attributes. With additional classes and attributes of the CIM 15 naming architecture this number could double and therefore make the full model far more verbose.

5.4.2 Context and meaning ambiguity

In the CIM concept, network resources were intended to have only one *Master Resource Identity* (mRID), normally provided by the instantiated value of the Resource Description Framework identity statement (rdf:ID). This is optimised within a single-point-of-data-entry modeling environment, as referred to in [60] with semantic meaning constrained within the scope of a single CIM XML namespace (see Section 2.6 for an initial explanation of namespace). The namespace is crucial to the integrity of KR because it provides an essential contextual reference to the CIM class orchestrated by

the schema. In this sense the namespace provides ‘information about’ and class, ‘meaning of’, for each model object. In Fig. 38, a reference framework corresponding to Fig. 34 is presented, describing the containment structures for knowledge about an instantiated object.

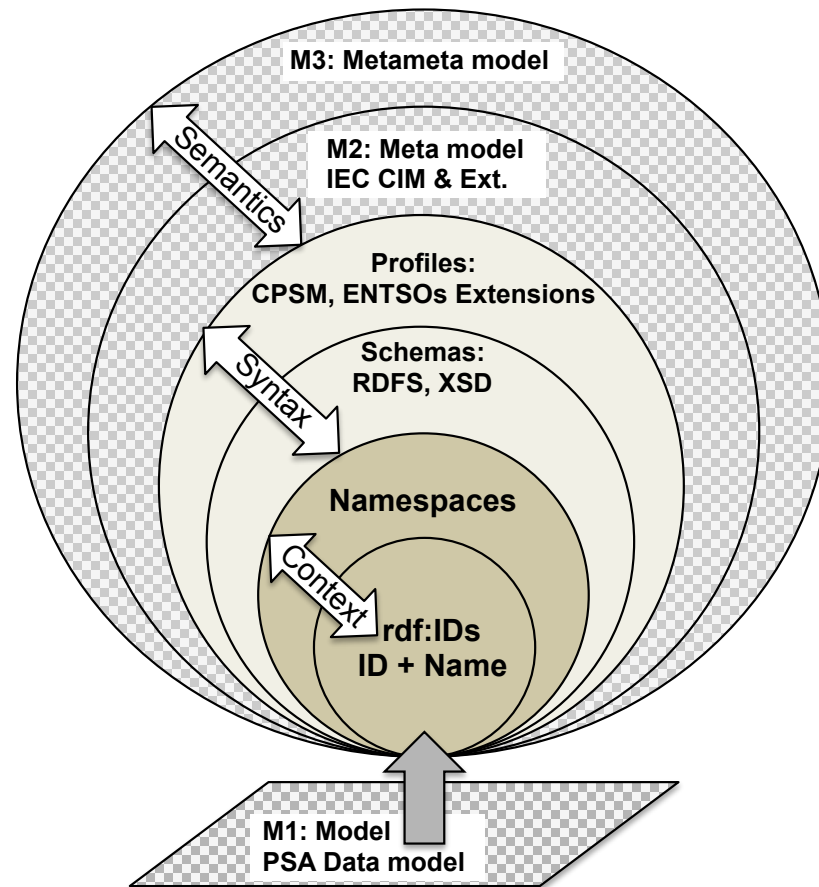

Fig. 38. Resource recognition and containment with modelling reference architecture.

If a unique mRID is not attached to the same network resource at the time of data modeling, identity ambiguities can arise when models are shared and merged [187]. This is manageable but with considerable effort required to rationalise identity collision problems in a scenario involving a small number of participating PSAs. Several authors have encountered this problem when attempting enterprise PSA model integration programmes [136,138,140] as well as model integration between enterprises [127]. However with a larger number of PSAs contributing their KRs of utility networks, markets and assets, the single namespace or context principle has significant disadvantages to KR. These arise in cases where there are multiple points of data entry from PSAs referring to the same power system resource in use

cases involving multiple parties with overlapping model boundaries described in Section 5.5 below. As this is common practice, the opportunity for data identity collision and *recognition* problems occurs and undermines the potential KR value from merging different perspectives of utility reality.

Recognition problems arise because containment of all mRIDs within a single namespace results in the loss of resource *genealogy* to the original PSA and therefore the context of its 'view' of network reality. Diversity of PSA views of network reality are worthy of preservation in a repository as the aim is to recreate an 'abstract reality' representative of the real network and associated environments. Individual PSA models will contain a complexity of naming and identity structures and strategies that are encapsulated within its CIM XML namespace. The more models that are coherently merged from different PSA perspectives the more complete the abstract reality, or KR, of the real network environment becomes.

5.5 Research motivation

In view of the above analysis of KR challenges this thesis proposes that the current convention to use a single CIM XML namespace is disadvantageous when merging multiple metadata models within a model repository such as that used within a NMMS. The use of different namespaces for multiple PSAs has various advantageous for the following reasons:

- Multiple namespaces assist in creating a realistic abstract representation of the real network environment as modelled within different PSAs.
- Filtering of merged models within a repository by PSA namespace retains their genealogic connection to the originating PSA – this is useful for PSA model version management and the speed with which different parts of the composite repository model can be processed in validation, import and export operations.
- Maintaining namespaces around individual PSA models reduces the opportunity for resource recognition problems and therefore also resource identity ambiguity.

- Model Naming Authority can be retained by PSA data owners within the scope of their own namespace, effectively addressing the class proliferation issues described in Section 5.4.1 and reducing the necessity to exploit “CIM:IdentifiedObject” naming architecture (Fig. 37).
- Identity collisions can be handled in a way that accommodates multiple network representations from different PSAs and therefore reduces the intensity of efforts required to maintain and reconcile them within a single namespace.
- The CIM namespace can be maintained as the principle container of generic classes concerning all models – such as the metamodel version and release number. PSA namespaces will contain metadata model classes instantiated in respect of its specific data model.
- Utility and vendor model extensions can be more easily identified if contained within their own namespace.

The following Sections of this Chapter will be devoted to describing the use cases and demonstration of a novel repository methodology to manage multiple CIM RDF XML model files.

5.6 Use cases considered for model repository demonstration

In a preliminary work to the repository demonstration, Hargreaves *et al* [187] reported on a use case involving the merging of EMS models with Registration Database (RDB) models containing generator configurations, before importing them into a Data Historian (Fig. 39). This paper established some of the principles employed in the following work to create a CIM metadata model repository reported on in [196] and presented next. These principles included the partitioning of EMS and RDB models within separate PSA namespaces and the use of RDF-controlled incremental updates to the merged CIM RDF XML models held in the repository tool.

The use cases concern CIM equipment profiles (CIM .EQ files) and acknowledge that these can differ in their representation of the network depending on whether connectivity information (such as ConnectivityNode instances) is included in the profile used. For example the IEC 61970-452

standard, known as “CPSM profile” does contain connectivity information and is used by operational PSAs such as the EMS and EBS, while the ENTSO-E, Edition 1 profile, used by National Grid planning PSAs, does not. The implication of this is we will find different connectivity representations in the CIM metadata files of the same network reality. A legacy of different names given to the same power system resource, data silos within different PSAs referring to common network resources and multiple points of data entry are also to be expected. We must therefore accept that complexity in names, IDs and data referring to common network resources is inevitable. Each PSA will contribute a data representation of network reality in dependence upon its functional perspective, or context. Thus, each PSA will have a different orientation to a common network resource and will describe it only in the partial terms necessary for its functionality.

As a single point of asset naming and identification no longer exists within National Grid for network operation, this work was motivated by the business benefits of resource knowledge reconstruction using a metadata model

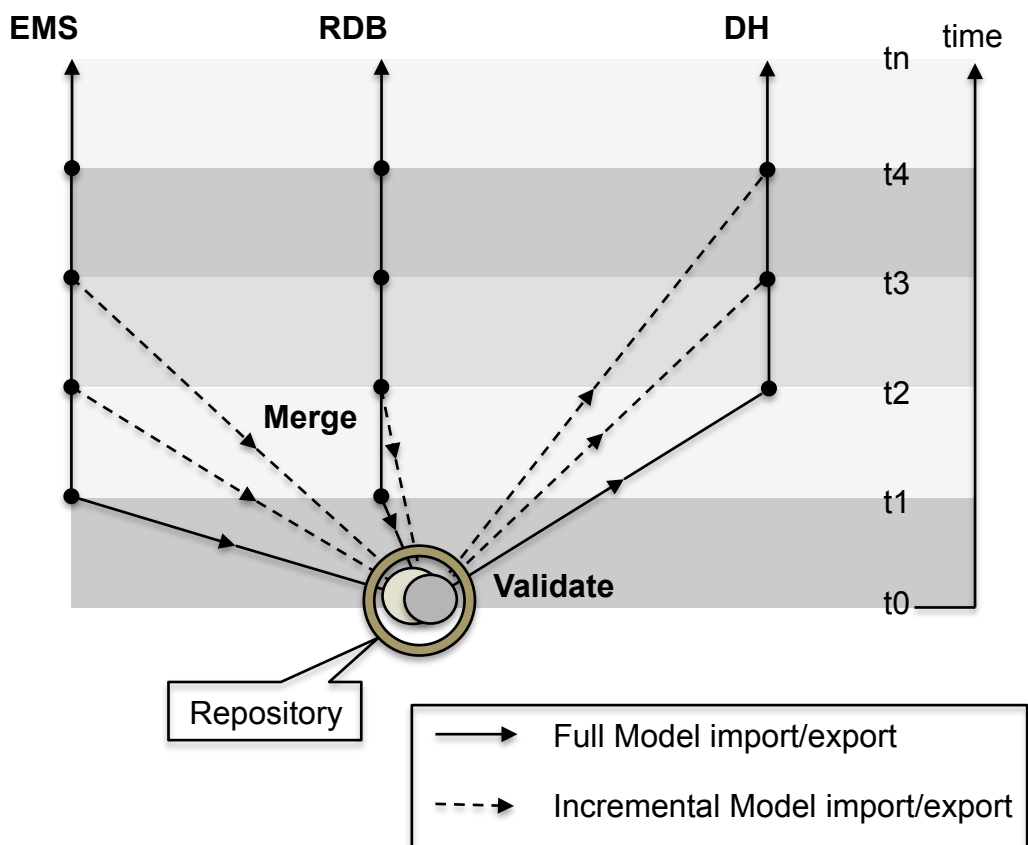

Fig. 39. Schematic representation of EMS-EBS-DH use case. Showing time sequence of model merges and validation of EMS and EBS models before export to DH.

repository. The investigation was based on the three model exchange scenarios as follows (Fig. 40):

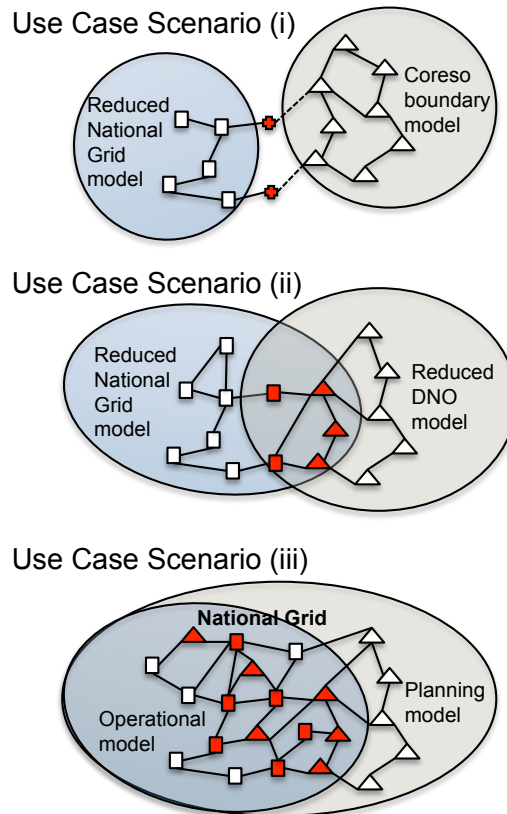

Fig. 40. Schematics of use case scenarios. Network resources in red form boundary models.

A. Scenario (i)

This applies to the use of a network model describing the region of the GB network interconnecting with the network of different Transmission System Operators (TSOs), as in the case of model sharing with Coreso [17]. Coreso, as a Regional Coordination Service Centre, combines non-overlapping models from its partners to facilitate operational security studies on cross-boundary power flows. Thin boundary models containing fictitious network interconnection nodes are maintained by the European Network of Transmission System Operators for Electricity (ENTSO-E) [16]. They are used by ENTSO-E members to enable modelling of interconnection for wide area network studies involving other European national transmission systems. This type of boundary model is merged within the National Grid CIM RDF XML metadata model before export to Coreso to facilitate studies on

boundary congestion and security ahead of real time with models provided by neighbouring utilities.

B. Scenario (ii)

This applies to the exchange of network metadata models between DNOs, TOs, OFTOs and National Grid. Reduced models describing only the network equivalent at thick network boundaries, covering the National Grid owned Grid Supply Point (GSP) supergrid transformers to the DNO step-down transformers, are exchanged to support cross-boundary security analyses and operational visibility. In this process, parameter information is used for fault level and thermal assessments. Infrastructure changes reflected within the models are merged into the existing operator model to update network awareness

C. Scenario (iii)

This applies to the synchronization of common network parameters modelled by different PSAs within the same utility, sometimes described as seeking “one version of the truth”. Alignment of the National Grid Offline Transmission Analysis (OLTA) planning application model with operational online management systems such as the EMS, are examples of this use case. In this process, power system resources with different PSA genealogies and identities, would be aligned across their respective CIM RDF XML metadata models exported from each PSA. Alignment of common resource attributes presented within the objects of the metadata models would then make possible the option to synchronize or rationalize resource parameter values.

All of these model exchanges currently require considerable manual effort when approaches not involving common semantic metamodels are used to achieve alignment. In the case of scenarios (ii) and (iii), the operation currently takes several man-weeks of a power system engineer’s time and is therefore very costly. Automation of the following methodology could not only reduce the cost of such processes but also support efficient interoperability and understanding required for a smarter grid.

5.7 Repository methodology

The principal objective of the model repository is to align CIM metadata models around instantiated representations of common network resources as outlined in Fig. 41.

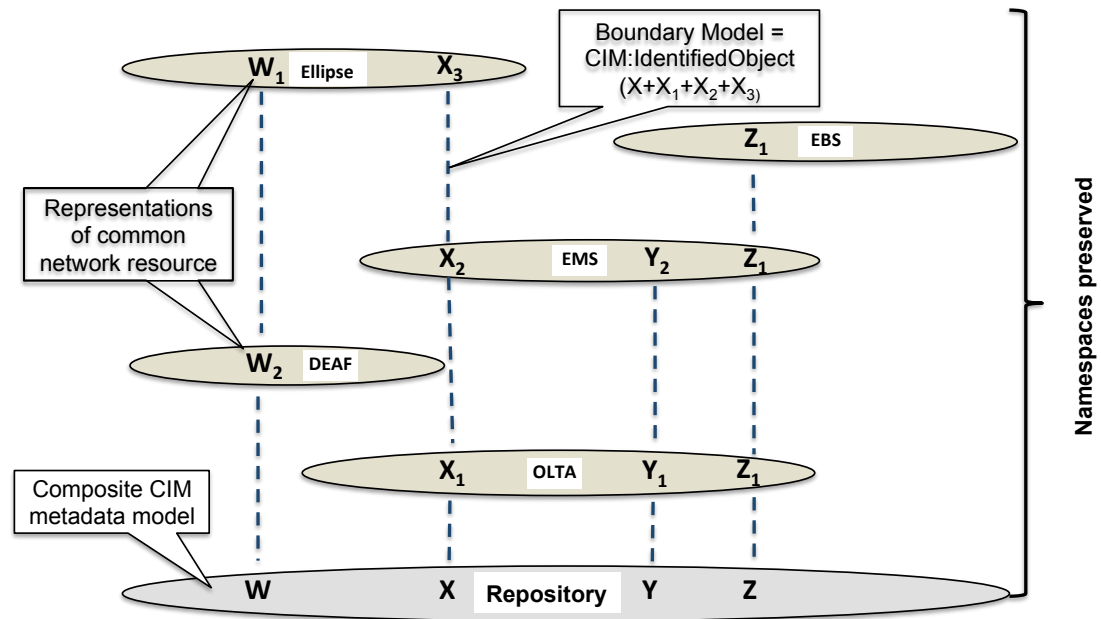

Fig. 41. Model alignment principle within repository. Models remain contained within their PSA namespaces while aligning over common boundary objects.

This process is valid for the thin boundary between models described in Scenario (i) but the option to synchronise parameter values for aligned representations of common power system resources becomes possible within Scenarios (ii) and (iii) and are the focus of the remaining discussion. It was estimated between 4% and 32% of objects within these National Grid CIM .EQ models would actually align, the rest of the objects being unique to each model's equipment inventories. This estimate derives from the division of the common class instances with 200000, an average number of class instances for each model. While the value of reported aligned objects in [196] was 4%, the above range can be interpreted as what is 'meaningful alignment' given that a majority of instances refer to power system resource terminals ("CIM:Terminal"). A "CIM:Terminal" class is defined as 'an electrical connection point to a piece of conducting equipment' and contains attributes referring to connection status, phases and sequence of connection.

The demonstration uses full CIM .EQ models conforming to IEC 61970 CIM14v15, the version of CIM currently used by National Grid. The files were

exported in CIM RDF XML from the CIM adaptors of the OLTA PSA and EMS PSA, representing Operational Planning and Energy Management System data models respectively. These models were chosen for the demonstration because of their central importance to network operation, which requires a close correspondence in their representation of the network, or ideally as a 'single version of the truth'. Both models were constrained to the ENTSO-E 'Edition 1' profile and loaded into a metamodel handling application used for model visualisation, comparison, merging and validation functions. CIMdesk [198] was used to handle the metadata models and build the repository because it is a standard tool issued to members by ENTSOE. It was modified to identify and display multiple namespaces instead of just the CIM namespace.

The CIM uses object oriented modelling techniques to represent modelled objects that follow a pattern of containment. 'Concrete' classes standing-for real network resources inherit from 'abstract' classes at a higher level in the class structure of the reference metamodel. A simplified recreation of the relevant parts of the CIM14 standard used by the National Grid CIM adaptors is shown in Fig. 42 in order to lay out the overall relationships of the sections through the models presented in the demonstration described below. Note that the ENTSOE profile is used as a filter for the CIM adaptors and constrains the number of classes required to model the instantiated metadata model. It therefore acts to simplify the communicated model structure compared with the reference standard model (IEC 61970). A further simplification of the communicated model takes place because not all of the attribute parameters may be available in the PSA data model and so they do not instantiate in the communicated model. Power system resources that do instantiate here inherit from a "CIM:IdentifiedObject" class containing the rdf:ID parameter, as the "CIM:mRID", that is their predicate within the context of their XML namespace. This parameter value is essential to the structure of the communicated model and is referred to by other instantiated objects that have either an inheritance or association relationship with the parent class. In this way the CIM containment structure is constructed between different parts of the model (Fig 43).

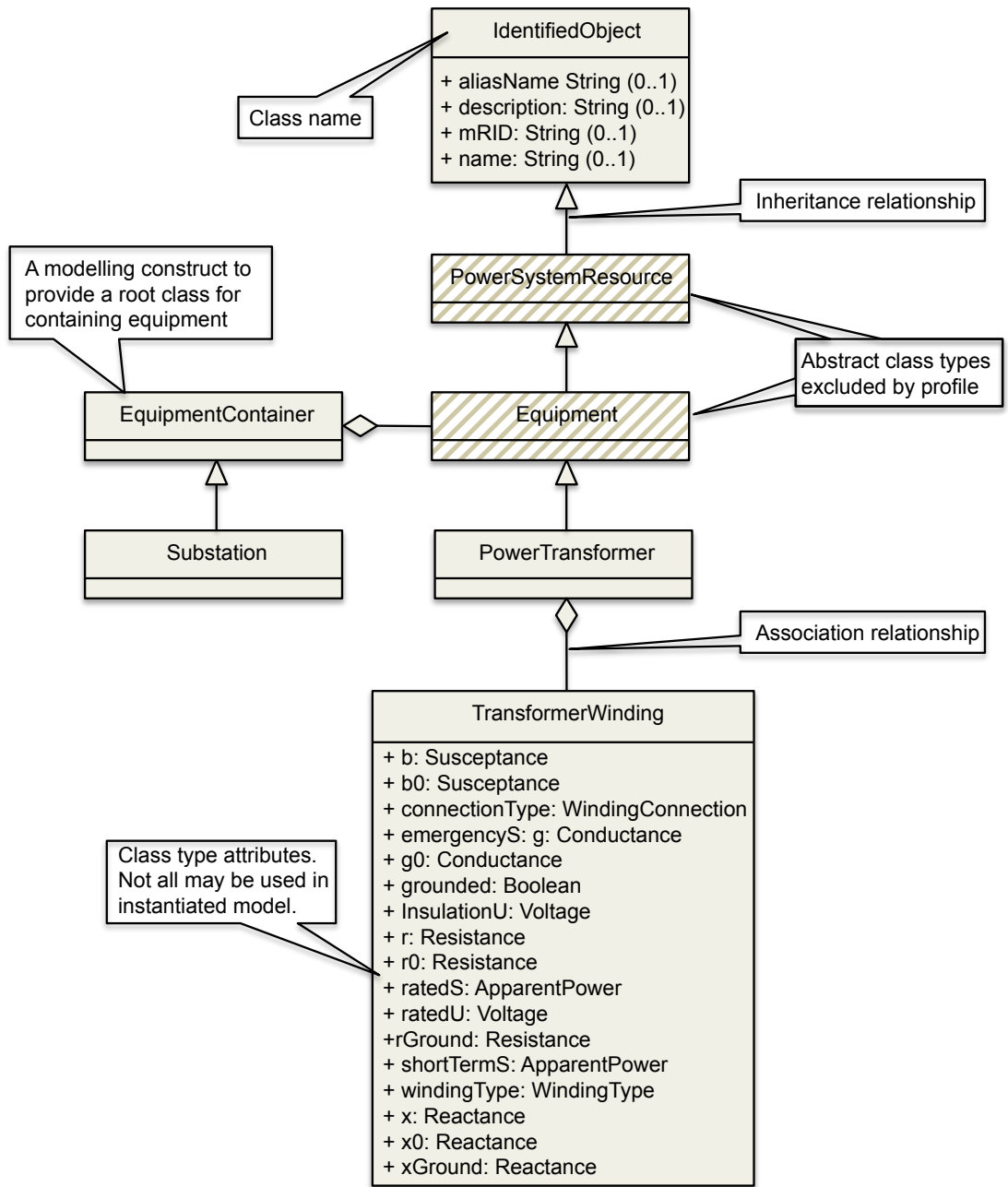

Fig. 42. IEC 61970-301 metamodel architecture for relevant sections of merged models.

Fig. 43 shows a screen shot of the CIM containment structure of the model resources aligned within the repository, as seen from the repository model handling tool.



Fig. 43 Repository file tree of containment structure for model sections used in demonstration.

5.7.1 Repository model management process

An overview of the repository model management process is presented in Fig. 44. The process begins at a time t_0 by loading the two PSA metadata models into the model handling application [198]. It would be impractical to show the full models used in the demonstration, as they are composed of around 200,000 objects in each model, so edited sections of the metadata model code chosen to exemplify the principles of creation and use of the repository are given in the following figures. These sections cover the modelling of a substation, a transformer and one of its windings within that substation. These objects were chosen, as they are common power system resources modelled within both PSA data models. Namespaces corresponding to the CIM (as a reference to the standard profile schema) and originating PSA are declared in the model headers and preserved in the subsequent code to identify the PSA responsible for the model and thus the genealogy of the name-identity coupling given to a particular resource.

(1) The OLTA metadata model was chosen as the Master model because it has a higher resolution representation of its component level data model compared to the lower resolution bus-branch data model used internally by the EMS. As the repository becomes composed of a mosaic of merged models it will default to the role of Master model. The model handling tool utilises embedded RDF operations to carry out updates between two models using *incremental* models as far as possible. Because the direction of

update is important, it is necessary to select which of the two models are Master and Slave, to determine which model becomes the incremental to the other.

Fig. 45 and Fig. 46 show part of the CIM RDF XML communicated models of the OLTA and EMS PSAs, relating to a common substation, power transformer and a transformer winding. The names and rdf:IDs of these resources have been changed for confidentiality reasons but their differences in the original versions are still reflected.

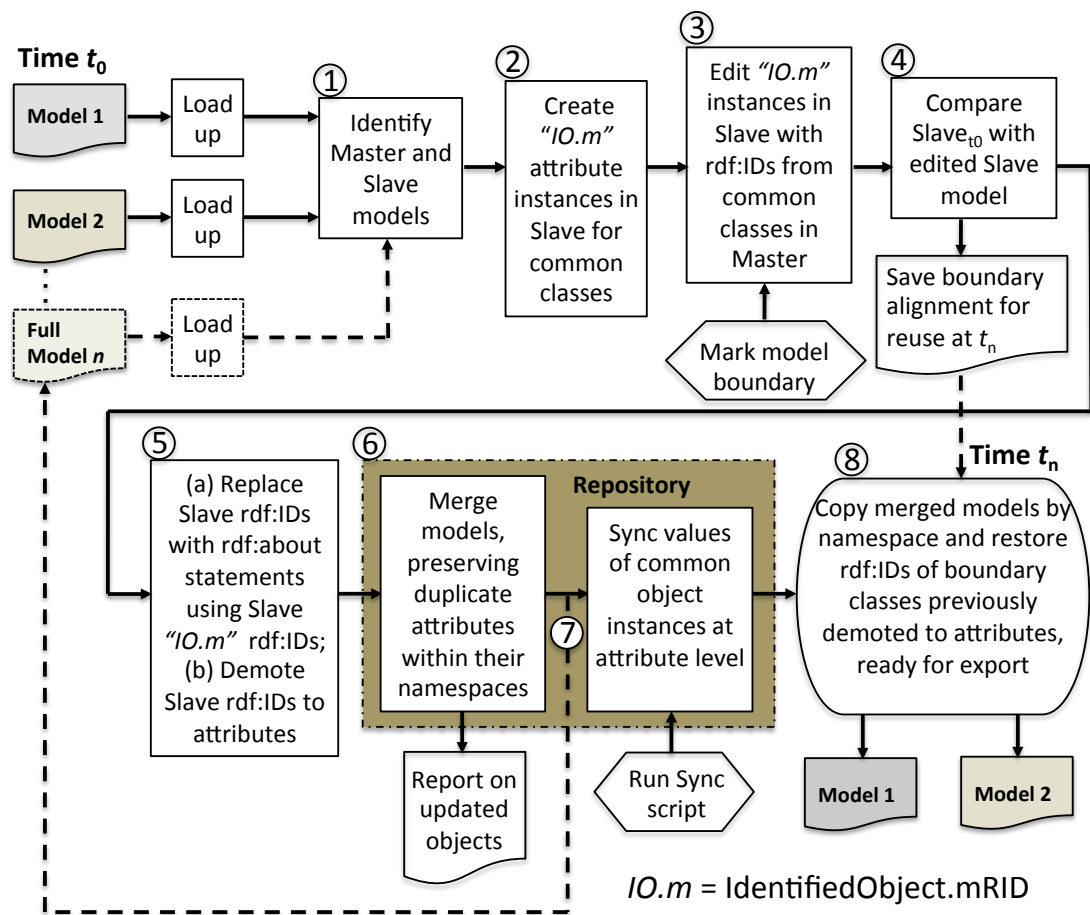

Fig. 44. Repository model management process.

(2) The process of boundary identification between the models begins by annotating the Slave (EMS) model with metadata. This ‘injects’ “IdentifiedObject.mRID” statements into the Slave metadata model (see lines 14, 18 and 22 in Fig. 47) in preparation for adding the Master rdf:IDs in the next step. These attribute statements act as “hooks,” that will eventually align the slave model to the master model. The use of the “IdentifiedObject.mRID”

attribute, which is already part of the CIM reference metamodel avoided the need for a proprietary model extension.

As the ability for automated reasoning to 100% confidently recognise identical objects with heterogeneous identities instantiated within different metadata models has not yet been developed, it was necessary to manually annotate the models with metadata. This process is concerned with instantiated objects within metadata models and thus sits at a lower level than semantic harmonisation. Automation may speed-up the alignment process in future but not entirely remove the need for human supervision until 100% accurate. The pattern-matching process is not one of simply identifying the common semantic describing the power system resource object, but also the associated metadata of its identity and name(s).

```

1 <?xml version="1.0" encoding="UTF-8" standalone="yes"?>
2 <rdf:RDF xmlns:rdf="http://www.w3.org/1999/02/22-rdf-syntax-ns#"
3     xmlns:cim="http://iec.ch/TC57/2009/CIM-schema-cim14#"
4     xmlns:olta="http://www.nationalgrid.com/olta/2009/CIM-schema-cim14#"
5     xml:base="http://www.nationalgrid.com/repository/">
6
7 <olta:Substation rdf:ID="_XXX1">
8   <olta:IdentifiedObject.aliasName>AZKABAN</olta:IdentifiedObject.aliasName>
9   <olta:IdentifiedObject.name>AZKABAN 275KV</olta:IdentifiedObject.name>
10 </olta:Substation>
11
12 <olta:PowerTransformer rdf:ID="_XXX1.1">
13   <olta:Equipment.MemberOf_EquipmentContainer rdf:resource="#_XXX1" />
14   <olta:Equipment.equivalent>>false</olta:Equipment.equivalent>
15   <olta:IdentifiedObject.aliasName>SGT 3</olta:IdentifiedObject.aliasName>
16   <olta:IdentifiedObject.name>AZKA SGT 3</olta:IdentifiedObject.name>
17 </olta:PowerTransformer>
18
19 <olta:TransformerWinding rdf:ID="_XXX1.1.1">
20   <olta:TransformerWinding.MemberOf_PowerTransformer rdf:resource="#_XXX1.1" />
21   <olta:TransformerWinding.b>-3.36646e-006</olta:TransformerWinding.b>
22   <olta:TransformerWinding.b0>-7.93388e-005</olta:TransformerWinding.b0>
23   <olta:TransformerWinding.connectionType
24   rdf:resource="http://iec.ch/TC57/2009/CIM-schema-cim14#WindingConnection.Y" />
25   <olta:TransformerWinding.g>1.13388e-006</olta:TransformerWinding.g>
26   <olta:TransformerWinding.g0>0</olta:TransformerWinding.g0>
27   <olta:TransformerWinding.r>3.53967</olta:TransformerWinding.r>
28   <olta:TransformerWinding.r0>3.53967</olta:TransformerWinding.r0>
29   <olta:TransformerWinding.ratedS>120</olta:TransformerWinding.ratedS>
30   <olta:TransformerWinding.ratedU>275</olta:TransformerWinding.ratedU>
31   <olta:TransformerWinding.rground>0</olta:TransformerWinding.rground>
32   <olta:TransformerWinding.windingType
33   rdf:resource="http://iec.ch/TC57/2009/CIM-schema-cim14#WindingType.primary" />
34   <olta:TransformerWinding.x>135.07</olta:TransformerWinding.x>
35   <olta:TransformerWinding.x0>125.992</olta:TransformerWinding.x0>
36   <olta:TransformerWinding.xground>0</olta:TransformerWinding.xground>
37 </olta:TransformerWinding>
38
39 </rdf:RDF>

```

Fig. 45. Master Model 1: Section of OLTA CIM RDF XML metadata model for a transformer winding within the Azkaban Substation.

```

1 <?xml version="1.0" encoding="UTF-8" standalone="yes"?>
2 <rdf:RDF xmlns:rdf="http://www.w3.org/1999/02/22-rdf-syntax-ns#"
3     xmlns:cim="http://iec.ch/TC57/2009/CIM-schema-cim14#"
4     xmlns:ems="http://www.nationalgrid.com/ems/2009/CIM-schema-cim14#"
5     xml:base="http://www.nationalgrid.com/repository/">
6
7     <ems:Substation rdf:ID="_YYY1">
8       <ems:IdentifiedObject.name>AZK</ems:IdentifiedObject.name>
9     </ems:Substation>
10
11    <ems:PowerTransformer rdf:ID="_YYY1.1">
12      <ems:IdentifiedObject.name>AZK SGT1</ems:IdentifiedObject.name>
13      <ems:Equipment.Container rdf:resource="#_YYY1"/>
14    </ems:PowerTransformer>
15
16    <ems:TransformerWinding rdf:ID="_YYY1.1.1">
17      <ems:IdentifiedObject.name>AZK SGT1</ems:IdentifiedObject.name>
18      <ems:TransformerWinding.g>0.0</ems:TransformerWinding.g>
19      <ems:TransformerWinding.x>135.07002</ems:TransformerWinding.x>
20      <ems:TransformerWinding.b0>-0.008699481</ems:TransformerWinding.b0>
21      <ems:TransformerWinding.g0>2.2783199E-4</ems:TransformerWinding.g0>
22      <ems:TransformerWinding.r>3.53925</ems:TransformerWinding.r>
23      <ems:TransformerWinding.windingType
24      rdf:resource="http://iec.ch/TC57/2009/CIM-schema-cim14#WindingType.primary"/>
25      <ems:TransformerWinding.x0>114.8706</ems:TransformerWinding.x0>
26      <ems:TransformerWinding.b>-1.6819835E-6</ems:TransformerWinding.b>
27      <ems:TransformerWinding.ratedS>150.0</ems:TransformerWinding.ratedS>
28      <ems:TransformerWinding.r0>3.0083628</ems:TransformerWinding.r0>
29      <ems:TransformerWinding.ratedU>275.0</ems:TransformerWinding.ratedU>
30      <ems:TransformerWinding.xground>0.0</ems:TransformerWinding.xground>
31    </ems:TransformerWinding>
32
33 </rdf:RDF>

```

Fig. 46. Slave Model 2: Section of EMS CIM RDF XML metadata model for a transformer winding within the 'Azkaban' Substation.

(3) The rdf:ID values (lines 7, 12, 19 of Fig. 45.) of the common classes from the Master model were then copied into the string space of the "IdentifiedObject.mRID" attributes (see lines 14, 18, and 22 in Fig. 47). This step is equivalent to marking the boundary of common instantiated class objects that links the two models together.

(4) By comparing the newly edited Slave model with its original version in the model handling tool we identified just those classes that constituted the boundary with the Master model. This boundary 'alignment' file can be used to create an "rdf:DifferenceModel" (Fig. 47), which is then used to aid in the preparation of merging the EMS Slave model into the repository (5). The boundary alignment information is also saved for re-use at the time a version of the Slave model is exported from the repository. It contains the detail of which "Slave:IdentifiedObject" classes of the exported model must be re-adjusted to appear as they did before entry to the repository, by recreating

“IdentifiedObject rdf:ID” statements. The boundary alignment file can also act as a reference to any boundary objects have changed when a new version of the Slave model is added to the repository, avoiding much of the work of steps (2) and (3).

```

1 <?xml version="1.0" encoding="UTF-8" standalone="yes"?>
2 <rdf:RDF xmlns:rdf="http://www.w3.org/1999/02/22-rdf-syntax-ns#"
3   xmlns:dm="http://iec.ch/TC57/61970-552/DifferenceModel/1#"
4   xmlns:cim="http://iec.ch/TC57/2009/CIM-schema-cim14#"
5   xmlns:olta="http://www.nationalgrid.com/olta/2009/CIM-schema-cim14#"
6   xml:base="http://www.nationalgrid.com/repository/">
7
8 <dm:DifferenceModel rdf:about="">
9   <dm:reverseDifferences rdf:parseType="Statements">
10  </dm:reverseDifferences>
11
12 <dm:forwardDifferences rdf:parseType="Statements">
13   <rdf:Description rdf:about="#_YYY1">
14     <olta:IdentifiedObject.mRID>_XXX1</ems:IdentifiedObject.mRID>
15   </rdf:Description>
16
17   <rdf:Description rdf:about="#_YYY1.1">
18     <olta:IdentifiedObject.mRID>_XXX1.1</ems:IdentifiedObject.mRID>
19   </rdf:Description>
20
21   <rdf:Description rdf:about="#_YYY1.1.1">
22     <olta:IdentifiedObject.mRID>_XXX1.1.1</ems:IdentifiedObject.mRID>
23   </rdf:Description>
24
25 </dm:forwardDifferences>
26 </dm:DifferenceModel>
27 </rdf:RDF>

```

Fig. 47. Slave “rdf:DifferenceModel” loaded with OLTA “IdentifiedObject.mRID” statements targeting EMS objects.

In RDF, merging a file containing “forwardDifferences” (eg. lines 12-25 of Fig. 47) will update the other file containing the ‘target’ objects (identified by the “rdf:about” statements) by adding the information contained inside the “forwardDifference” statement. In the case of “reverseDifference” statements (eg. lines 9-10 of Fig. 47), it will remove information from the targeted statements. Merging the “rdf:DifferenceModel” of Fig. 47 with the Slave model will therefore add, or annotate, the Slave model with the Master “IdentifiedObject.mRID” metadata statements corresponding to the target objects identified.

(5) Having added these metadata annotations to the Slave model, a further two-step process must be carried out before the Slave model can be merged into the repository. This is outlined in Fig. 48 and involves rotating the Master and Slave boundary object identities (see lines 13-14, 17-18 and 21-22 of Fig. 47) now combined in the Slave model after Step (4) above. This promotes

the “olta:IdentifiedObject.mRID” to become the Master identity for the class of Slave parameters within the same object. It also demotes the “Slave:IdentifiedObject rdf:ID” to become an “ems:IdentifiedObject.mRID” attribute parameter belonging to the same object. This retains the identity belonging to slave parameter attributes for reinstatement later at the point the model is exported from the repository. This process prepares common objects and associated attributes within each model for merging into the repository within the model handling tool.

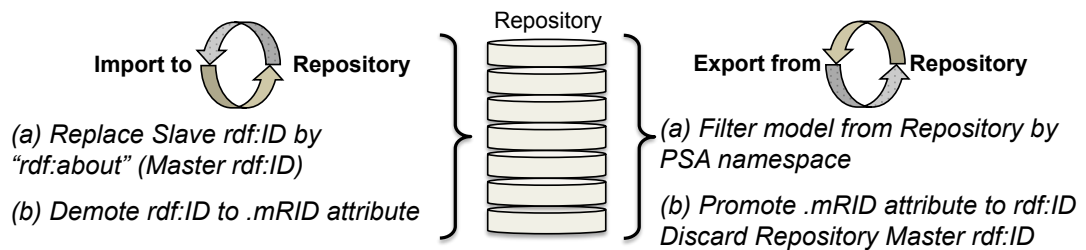

Fig. 48. Object identity rotation process on Slave model import and export from repository.

(6) Slave and Master (Repository) models are merged. The KR context from each contributing PSA is maintained by preserving the XML namespaces containing each metadata model. Maintaining separation between the models in this way enables clear identification of respective PSA metadata model contributions (genealogy) to the repository and supports the comparison, synchronisation, or rationalisation of attribute parameter values of common objects, subsequently. Partition of repository models also assists with the export process described below.

Fig. 49 shows the report from the model handling tool of the merge between the aligned sample of sections of Master and Slave metadata models presented in Fig. 45 and Fig. 46. through use of the boundary model in Fig. 47. In Fig. 49. the attributes and their values instantiated within the “Substation”, “Transformer” and TransformerWinding” class objects allows an examination of the range of attributes and forms a more complete representation of network reality from the functional perspectives of the contributing PSAs.

(7) At this juncture, the repository has been created within the model handling application. In Fig. 49 we can see the namespace identifying the

[AZK_repository_] Substation : AZK			
Namespace	Attribute	Type	Value
rdf	ID	ID	_XXX1 Locate this object in CIM Tree
olta	IdentifiedObject.aliasName		AZKABAN
ems	IdentifiedObject.mRID		_YYY1
olta	IdentifiedObject.mRID		_XXX1
ems	IdentifiedObject.name		AZK
olta	IdentifiedObject.name		AZKABAN 275KV

[AZK_repository_] PowerTransformer : AZK SGT1			
Namespace	Attribute	Type	Value
ems	IdentifiedObject.name		AZK SGT1
olta	IdentifiedObject.name		AZKA SGT 3
ems	IdentifiedObject.mRID		_YYY1.1
olta	IdentifiedObject.mRID		_XXX1.1
olta	IdentifiedObject.aliasName		SGT 3
rdf	ID	ID	_XXX1.1 Locate this object in CIM Tree
olta	Equipment.equivalent	Boolean	false
olta	Equipment.MemberOf_EquipmentContainer	(Substation)	_XXX1
ems	Equipment.EquipmentContainer	(Substation)	_XXX1

[AZK_repository_] TransformerWinding : AZK SGT1			
Namespace	Attribute	Type	Value
rdf	ID	ID	_XXX1.1.1 Locate this object in CIM Tree
ems	IdentifiedObject.mRID		_YYY1.1.1
olta	IdentifiedObject.mRID		_XXX1.1.1
ems	IdentifiedObject.name		AZK SGT1
olta	TransformerWinding.MemberOf_PowerTransformer	(PowerTransformer)	_XXX1.1
ems	TransformerWinding.PowerTransformer	(PowerTransformer)	_XXX1.1
ems	TransformerWinding.b		-1.6819835E-6
olta	TransformerWinding.b		-3.36646e-006
ems	TransformerWinding.b0		-0.008699481
olta	TransformerWinding.b0		-7.93388e-005
olta	TransformerWinding.connectionType	Enumeration	WindingConnection.Y
ems	TransformerWinding.g		0.0
olta	TransformerWinding.g		1.13388e-006
ems	TransformerWinding.g0		2.2783199E-4
olta	TransformerWinding.g0		0
ems	TransformerWinding.r		3.53925
olta	TransformerWinding.r		3.53967
ems	TransformerWinding.r0		3.0083628
olta	TransformerWinding.r0		3.53967
ems	TransformerWinding.ratedS		150.0
olta	TransformerWinding.ratedS		120
ems	TransformerWinding.ratedU		275.0
olta	TransformerWinding.ratedU		275
olta	TransformerWinding.rground		0
ems	TransformerWinding.windingType	Enumeration	WindingType.primary
olta	TransformerWinding.windingType	Enumeration	WindingType.primary
ems	TransformerWinding.x		135.07002
olta	TransformerWinding.x		135.07
ems	TransformerWinding.x0		114.8706
olta	TransformerWinding.x0		125.992
ems	TransformerWinding.xground		0.0
olta	TransformerWinding.xground		0

Fig. 49. Screen shots from model handling tool. Showing alignment of Substation, Transformer and TransformerWinding CIM metadata model objects within repository.

genealogy of the object (highlighted in the blue banners) to its originating PSA under the “Namespace” column. Attributes of these objects are listed under the “Attribute” column with their values listed under the “Value” column. We can reiterate the process linking additional metadata models into the repository model.

It is now easy to compare and contrast differences in values for the same attribute derived within common objects from the merged PSA models. For example, examination of the positive sequence resistance attribute values for the transformer winding modelled by OLTA (“olta:TransformerWinding.r” Fig. 45, line 27) and the EMS (“ems:TransformerWinding.r” Fig. 46, line 22) show a difference of 0.00042 Ohms. It is differences such as these that lead to a divergence in the truth of representations of the same network reality. A script designed to identify (from the saved boundary file) and synchronise the parameter values of the common object attribute instances, if convergence in KRs were desired in line with a single version of the truth approach, could now be run. This is an important consideration when designing business processes such as building and updating the EMS data model from the Operational Planning data model, or aligning the planning models of DNOs with the planning model of the TSO for example. This does not imply the update direction need be from Master to Slave however, such as in cases where the Slave updates the Master. Parameter synchronisation would be similar to an RDF ‘update’ operation between Master and Slave models but at the attribute level.

(8) As the repository is composed of models partitioned by namespace it is possible to separate, copy or extract any model, filtering it by namespace. Updating PSA data models after parameter synchronization in the repository is possible by re-importing its metadata model through the CIM adaptor. Before a Slave model is exported (at time t_n in Fig. 44), it is necessary to restore the status of boundary object rdf:IDs to their original value by promoting them back from attribute level to rdf:ID statement level (Fig. 48). The boundary objects are identified from the boundary alignment file created and saved before the model was merged into the repository (Step 4). This process could be automated within the repository management application.

5.7.2 Repository Maintenance Through Time

The use of CIM is understood to apply to a snapshot in time and metadata models will instantiate objects differently as the PSA models they represent change through time in accordance with network resource outages and

connectivity. The CIM metadata model repository stands for temporal network reality and so requires a methodology to remain a true representation of the network reality it models. The biggest impact upon the repository will arise from changes to the model boundaries linking the repository together. Changes made here from any contributing model affect repository integrity and require an additional set of actions to those described in Fig 44. Changes to objects outside of the model boundaries are important in terms of truth to reality but do not impact upon repository integrity.

Changes to PSA metadata models are reflected in their forward and reverse differences, evident from a comparison between two models of different creation times. If these changes concern the boundaries of a Slave model, there is less maintenance required to the repository because these are limited to the scope of the Slave model. Changes to the Master model boundaries have higher impact due to its linkage to other metadata models within the repository. In Table 3 a range of repository maintenance solutions is presented including actions that could occur over a range of different scenarios for times t_1 to t_6 . Time t_0 represents when the repository is created, as shown in Fig. 44.

Table 3. Scenarios and solutions relating to temporal model management within the repository.

Time	Scenario	Solution
t_0	Repository is created with Master & Slave models	Slave rdf:IDs demoted and pointed towards mRIDs of Master objects (see Fig. 44 & Fig. 48.)
t_1	Slave _{t_0} model changes in PSA affect boundary with Master model within repository	Slave _{t_0} is extracted (filtered) from repository. Slave _{t_0} to Slave _{t_1} model comparison creates difference file indicating changes affecting boundary alignment file made at t_0 . Identified Slave _{t_1} boundary rdf:IDs demoted and model merged with repository.
t_2	Master model changes in PSA affect boundary with Slave models within repository	Master _{t_0} model is compared to Master _{t_2} model creating difference file. Difference file directs where changes necessary to affected Slave boundary alignment files. Slave _{t_1} models are extracted from repository to make affected boundary changes (Slave _{t_2}). Master _{t_0} model extracted from repository and replaced by Master _{t_2} model. Slave _{t_2} models are merged into Master _{t_2} model to reform repository.
t_3	PSA is replaced	See appropriate solution from t_1 or t_2 depending on status of model.
t_4	PSA is decommissioned and not replaced	Decommissioned PSA model is extracted from repository. If t_4 applies to a Master model then a Slave model is promoted to Master and new boundary files describing linkage to other common Slave objects are required. Slave models are extracted from repository to make affected boundary changes. The new Master model is created by promoting its rdf:ID values to mRIDs and then remaining Slave models are merged into it according to Solution _{t_0} .
t_5	Some PSAs upgraded to use latest CIM standard metamodel release	See appropriate solution from t_1 or t_2
t_6	Some PSAs are updated to use non-standard profile	See appropriate solution from t_1 or t_2

5.8 Further work

Key areas of the work described in this Chapter that lend themselves to further development are:

- Automation of some of the manual processes to identify and rotate the values of object mRIDs.
- The addition of version management mechanisms for recording the import and export of models into and out of the repository.

- The development of a layered SOA that extends the knowledge base within the repository into business systems for the purpose of developing business intelligence supporting decisions and actions (Fig. 31).

There is also potential for extending the IEC 61970 standard to accommodate additional metadata within the “CIM:IdentifiedObject” class to guide the identification of model boundaries before the merging process, which may promote automation. For example it is possible that some resources (“CIM:Equipment”) could be annotated with GIS reference metadata. But however fast and accurate pattern-matching routines may be, human supervision will still be required to confirm the identities of object ID instances in the absence of true Artificial Intelligence.

Model life cycle management is a pressing issue for any application that involves regular revision to stored files and the creation of subversions. It would be a priority in the development of practical use of the presented repository methodology to incorporate some form of Revision Control Software that enables Model Authorities to manage their part of the composite repository model and for other parties with the requisite privileges to access trusted versions. This matter can be investigated and a trial carried out with readily available open source and off-the-shelf solutions that check-in and check-out model versions from the repository.

Further demonstration of the repository would be useful for business intelligence applications and ontology engineering. This would require the development of new CIM profiles to filter the required metadata from the composite repository model. The building of an increasingly accurate knowledge representation of electrical power network reality within the repository is evolutionary, as a greater number of metadata models merge into it. In the sense of an ontology as “an explicit specification of a shared conceptualisation” [6] it could become the foundation of an *enterprise ontology* covering not only the domain of the CIM but wider business processes as well. Such as in the domain of harmonised standards like IEC 61850. Further work could investigate the composite repository model as a *foundation ontology* within a model-driven architecture used as a centralised

knowledge base for business intelligence. This would include the use of the repository as a resource for graphics, asset health and market analysis and widen the scope of repository applications.

5.9 Chapter Summary

This Chapter began by discussing the relationship of data to information, knowledge and intelligence. It presented a conceptual hierarchy that relates the importance of semantic and syntactic definitions within a given context to leverage the value of data into what has become known as the Knowledge Value Chain to provide decision support to business applications. The CIM was then placed in this context by referring to a standard OMG modelling hierarchy to explain a novel framework of understanding required to exploit the full value of CIM, RDF and XML technologies in knowledge representation.

Data ambiguities and the vexing problems of resource naming and identity were then discussed in the light of the evolution of ownership of data about a network resource from conception to inception within a power utility like National Grid. How data ambiguities result in identity and recognition collisions was then discussed. A novel infrastructure for centralised model Object Naming Authority and Registry was presented that used the built-in features of IEC 61970 in CIM 15. However this solution was seen as inferior to the proposed metadata model repository design due to the design limitations imposed by using only a single CIM namespace. In the proposed repository methodology realistic use cases were described that lend themselves to a multiple namespace approach from the point of view that different PSAs model the same network reality within their own context. As namespaces provide context, this element of the design is essential to creating a more realistic knowledge representation of the smart grid as more metadata models are combined within the repository.

A demonstration of a CIM metadata model repository was described in detail and several advantages of using this approach outlined with respect to some important information sharing use cases. Not least amongst these is the attempt to align online operational models (EMS, EBS) with offline operational models (OLTA) in their representation of the electrical power

network to approach the 'one version of the truth' scenario. This demonstration and the underlying framework for its understanding represent a significant contribution to the use of the IEC CIM in exploiting and leveraging the value of power system network data. As a template it has incidental applications in other fields where a similar need to share disparate information models referring to a common reality also exists.

It furthers the objective of multiple merged-model integrity as would be required within a utility metamodel repository at the heart of a NMMS by making the following contributions:

- Innovative resource identity management using namespaces, preserving name-ID genealogy.
- Improved CIM adaptor time performance for CIM model imports through namespace filters, by ignoring unqualified namespaces.
- Potentially reduces costs of building a shared common model repository, as with the proposed modeling approach, resources name authorities within CIM15 may not be required.
- In the context of a shared model repository a third party identity management system may not be required since this intelligence would be included within the namespace.
- A third party, commercial off-the-shelf solution to version management could be easily added to the repository application, reducing costs for extended functionality even further.

CHAPTER 6

EXTENSION OF IEC 61970 FOR ELECTRICITY STORAGE MODELLING

6.1 Introduction

This Chapter will further address the emerging issues of variability in supply and demand and derive use cases for grid-scale energy storage. Recent developments of modern electricity networks have begun to implement electricity energy storage (EES) technologies to provide ancillary balancing services, useful to grid integration of large-scale renewable energy systems. In view of the information exchange requirements arising from these use cases, it will then assess the ability of the current CIM standard IEC 61970-301 to model them. An investigation of the modeling of grid-scale electricity storage was also made, by drawing on information use cases for future smart grid operational scenarios at National Grid and reported on in [199]. It was found that current structures within the CIM do not accommodate the informational requirements associated with novel EES systems and so an extension to address this requirement is presented.

6.2 Balancing the grid: future energy scheduling challenges

In contrast to the deterministic nature of traditional energy dispatch, future operational scenarios proposed by National Grid anticipate supply and demand to be increasingly probabilistic leading to stochastic energy forecasting by TSOs. The complexity of this scenario can be attributed to a range of factors; these include, large weather-dependent renewable energy injections, interconnector flows and increases in embedded generation currently unmetered by the TSO; greater demand variability from consumers responding to weather and *time of use* tariffs through advanced metering infrastructures (AMIs), and anticipated large-scale use of electric vehicles and heat pumps. Some of the factors affecting future smart grid energy scheduling are visualized in Fig. 50.

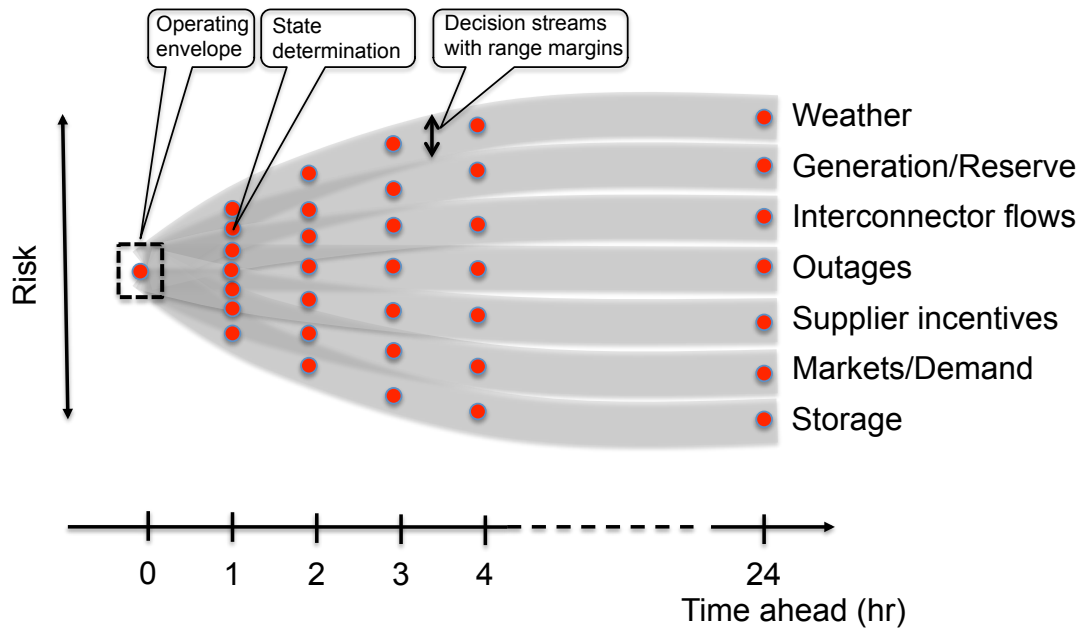

Fig. 50. Some emerging probabilistic inputs to multi-factorial energy forecasting by TSOs.

Further explanation of these factors follows below:

- The unpredictability of the weather - as it becomes increasingly responsible for providing energy supply – impacting upon dispatchable-scale generators to micro-scale embedded generation (EG). EG is not directly connected to the National Electricity Transmission System (NATS) but can have an impact upon it. It is predicted to rise to 15GW by 2020, or about 12% of generation capacity [12].
- The increasingly open electricity market, which includes more interconnection to electricity networks across Europe as well as a wider range of financial instruments influencing consumer demand choices. These may range from time-of-use tariffs to disconnection arrangements.
- The increasing reliance upon electricity by consumers, making the impact of their demand choices felt more strongly through Suppliers, DNOs and ultimately the TSO. Large changes in flows of electricity within the day are already experienced on the European continent

between national networks. This effect will be felt more strongly on the GB network as we become more interconnected and markets are opened-up. Interconnection of the GB network is planned to double to at least 6GW by 2020.

The problem of forecasting the optimum generation mix for balanced energy scheduling at real time is made more difficult by the increasing amount of variable generation, such as wind, combined heat and power (CHP) units and photovoltaic (PV) installations across the full spectrum of outputs from grid-connected to embedded generation. In particular the need to maintain frequency within statutory tolerances ($\pm 1\%$ of 50Hz) will demand greater flexibility in network management than at present. This problem will be compounded by the loss of system inertia. Large coal-driven rotating machines are being removed from the generation fleet due to the decarbonisation of generators. With increasing numbers of smaller machines in the form of wind turbines, managing high voltages derived from times of low demand (usually at night) and high wind speeds will present new challenges to the TSO, especially in times of scarcity of large-scale storage.

With a high expense to curtail wind generation, National Grid is therefore faced with two major challenges – unpredictable generation and high injection at times of low demand. With a projection of 30% wind load factor, they have identified the need for doubling the amount of Operating Reserve (including Short Term Operating Reserve Requirement, STORR) on the GB network from 4GW to 8GW to address control issues due to greater variability of network in-flows [12].

With more interconnection, flow management will become increasingly complex, requiring greater use of the new tools available to influence active and reactive power. These tools include Static Variable Compensators (SVCs), Quadrature Boosters (QBs) and Thyristor Controlled Series Capacitors (TCSCs). The dynamics of interconnector flows are sensitive to market and weather variability and will add to the complexity of arriving at a secure, risk-constrained price-optimised operating envelope as described in Chapter 4. Situational awareness and forward planning across the ENTSOE

affiliates by using service centres such as Coreso and TSC will become more important in helping to predict and manage cross-border flows.

Outage management will demand contingency planning for the loss of the largest single generating units (1800MW), an instance of where making use of dynamic line ratings will become necessary. Dynamic line ratings themselves will become more usable through greater situational awareness, particularly from knowledge of the wind speed and direction relative to the angle of a given line segment.

Extending this scenario further, as part of an Advanced Metering Infrastructure (AMI) some 20 million electricity smart meters are anticipated to be installed on the GB network by 2020. AMI will have the capability to perform rapid two-way information exchanges and some control functions that could be used to alter demand patterns. The biggest impact AMI may make upon National Grid and DNO control of the network could come from consumer interaction with services provided through the smart meter Head-end Devices (HEDs). Companies that offer services to consumers to seek out the best plans to suit their demand patterns and offer direction through their smart meter to make tariff selections are a distinct possibility for smart metering after 2020 [12]. Using an in-house interface that enables them to select a personalised pattern of payment for their electricity use, consumers may engage 'broker' applications, or agents, that seek out the optimum patterns of electricity payment for their electricity usage [200,201]. These will be driven by tariff incentives offered by energy suppliers and could produce automated electricity usage patterns depending on consumer preferences.

Compared with the relatively stable choices made by consumers currently, the frequency and rapidity of change in future consumer tariff choices could be very marked. This could lead to a greater risk for TSO and DNOs to stabilise the network if mass consumer switching to a different tariff occurs for example, within the gate-closure period for bulk electricity market arrangements (currently one hour ahead of real time). Rapid changes to national supply and demand would call upon the network operators to change their running and generation arrangements more frequently and at shorter notice. At present this action would require longer time spans than may be economically optimal to run the transmission system and therefore

suggests the need for more direct control over generators such as through Automatic Generation Control (AGC), or to dispatch expensive Spinning Reserve to help stabilise frequency or STORR to help stabilise voltage.

National Grid and DNOs are now considering the use of “time-of-use (ToU) tariffs”, demand-side services and storage to smooth out variations in the use of the transmission and distribution system, particularly with the arrival of a fully operational AMI [12]. ToU tariffs will vary the cost to the generator of using the network and will increase in cost as the capacity or thermal rating of the line is approached. Demand-side services offer a range of possibilities from agreements with large load centres like metal foundries, data centres and supermarkets to be available for load-shedding. At a domestic level, demand-side services would apply to the aggregated loads from domestic appliances (estimated to be around 4GW by 2020 [12]), heat-pumps and electric vehicle battery charging. With the emerging use of batteries as DERs for balancing supply and demand it is possible to recognise the immediate need to address the information modelling aspects of these and other storage technologies.

6.3 Research motivation

The motivation for the research described in this Chapter has been partly informed by Recommendation S-ES-1 in the IEC Smart Grid Standardization Roadmap [80]. This recommendation acknowledges that there is need for developing a generic description of the necessary data models to accommodate the different requirements and possibilities for large and distributed energy storage. It charges TC57 to develop an equivalent standard to IEC 61850-7-410 (hydro) for “connection of large and distributed storage equipment”. In [202] it was also noted that currently there is no general, technology-independent standard for EES. However in respect of the importance of EES systems for integration of renewable energy technologies (RETs) into the grid, IEC TC 120 was subsequently established in November 2012, to address the standardisation of entire EES systems [203]. Electrical energy storage systems are seen as important because they make an essential contribution to the integration of large scale RETs. Large scale and distributed storage can act like a ‘clutch’, adding flexibility to the

dynamic coupling of supply and demand by the grid, that has traditionally been matched in sub-second time scales. Joining EES systems to demand-side management technologies, that moderate consumption of power, provides a parallel mechanism of control to the traditional, dynamically-coupled ‘fuel-generation-transmission-distribution-consumption’ process chain. In Fig. 51 a simple representation of how EES systems could operate to support system balancing. Normally balanced supply and demand would appear as horizontal about the pivot shown in Fig. 51. As demand increased over available generation, causing the pivoted line to rise (as shown), EES would start to discharge in response, eventually supporting the return to a balanced position. In the opposite case of supply (generation) increasing over demand, EES (left hand end of line shown) would be invoked to begin charging in order to absorb some of the excess supply and therefore support the return to a balanced position.

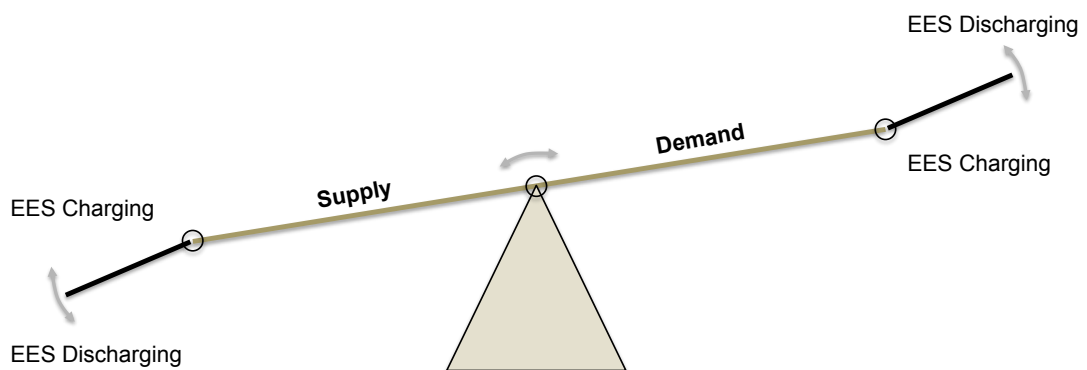

Fig. 51. Simplified representation of EES systems in smart grid balancing role.

It is also clear from the above survey of emerging challenges a combination of existing pumped hydro plant and new EES technologies will make an increasingly large contribution to the balancing of supply and demand [12,204,205,206]. This is because the diversity of operational characteristics of EES technologies and their functionalities are suited to the complex and temporally-critical requirements of the smart grid and not simply restricted to storing energy on a diurnal basis.

The purpose of the research reported on in this Chapter also responds to the challenges outlined in Section 6.2 by addressing the emerging need to

model information about EES technologies from the perspective of IEC CIM deployment for information interoperability. It is not aimed at modelling their operational characteristics *per se*, which will be the objective of sub-standards like IEC 61850-7-410 etc. The aim was to make a first attempt at establishing a generic CIM energy storage template that could be integrated into the existing IEC 61970-301 metamodel to support the need for control of grid-scale EES by TSOs within the wider context of large-scale RET integration into the smart grid. It also addresses the potential of the CIM to engage with a wider issue concerning energy modelling for energy security.

The rest of the Chapter will discuss some of the high level characteristics, roles and use cases of EES before presenting the proposed generalised CIM extension model.

6.4 Placing EES in context

Assessing EES technologies for suitability to different roles is a complex process and the topic of several detailed studies such as [202,207,208]. The difficulty of making assessments of EES is compounded by the emerging nature of many of the proposed technologies as well as the emerging nature of requirements for their use within the smart grid domain. The immaturity of markets has also yet to offer value to many of their services in order for them to properly compete financially and therefore become accepted solutions to smart grid use cases. However within this rapidly changing environment there seems to be little doubt that the ecosystem of different EES technologies will play an increasingly important role as the level of different RETs requiring integration into the smart grid ramps-up. Adding weight to this argument is the role of information systems that direct the operation of the smart grid and of themselves will also open-up further development of roles and applications of novel EES systems. In view of this, the need for integrated information models to support EES system control by network operators is an urgent requirement. This activity can take place both through developing existing standards within the IEC SIA as well as the development of new standards.

In [199] Hargreaves *et al* discussed the perspectives taken of the use cases for EES to approach designing a generic extension to IEC 61970 that

would be able to accommodate the modelling requirements for energy storage. These perspectives (Fig. 52) broadly reflect the background research motivations outlined at the beginning of this thesis (Sections 1.1.1 – 1.1.4) and represent a holistic background to the modelling that followed.

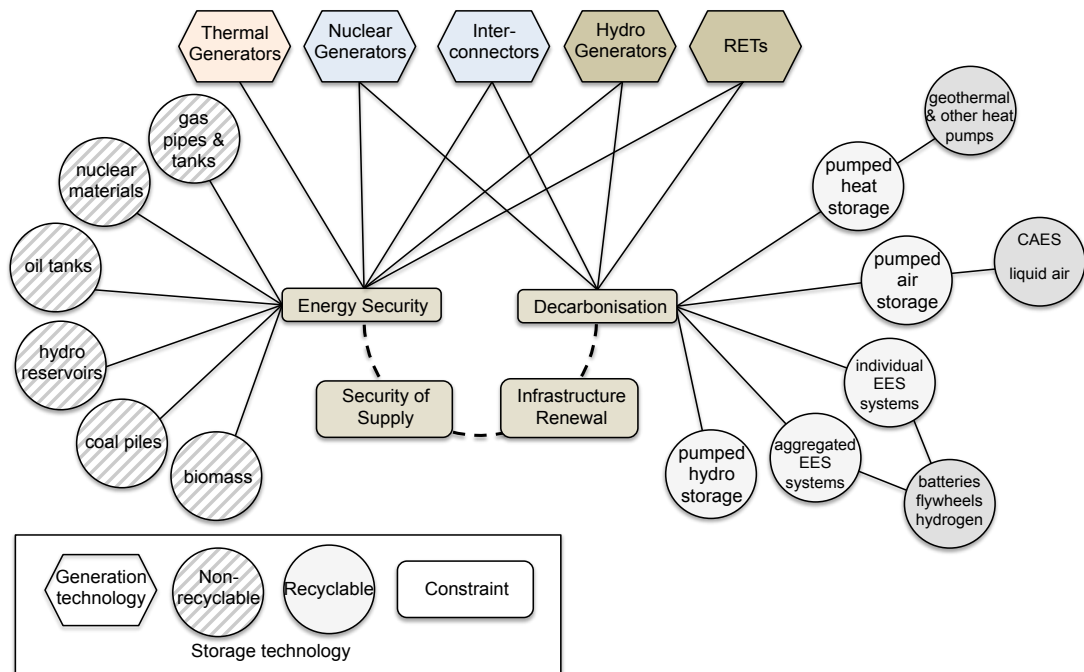

Fig. 52. Holistic perspective of methods relating to energy storage modelling.

The issue of electrical energy storage naturally overlaps with the wider matter of energy storage that is linked to differing fuel vectors such as coal, gas, hydro and nuclear. In Fig. 52. these are shown by the circles connecting to different generation technologies through the four “constraints” addressed previously in Sections 1.1.1-1.1.4 as motivations for this thesis. Characterisation of storage technologies in this way provides a basis for evaluating the capability of the IEC CIM to capture the information required to manage EES and energy storage in general. It helps to show those areas of this broad subject where the class structure of the CIM is currently active (such as in the case of thermal and hydro technologies) and lacking coverage such as in the “recyclable” storage technologies shown in the circles on the right of Fig. 52. This gave some direction to preparation of the model extension to address the perceived use cases as they emerge with EES technology deployment.

Characterising the impact of different methods of energy storage revealed how the traditional view of transmission systems from a distribution point of view could no longer be restricted to *supply*. Conversely, the traditional view of distribution systems from transmission point of view could no longer be limited to *load*. These views are changing due to the implementation of EES systems of different sizes ranging from domestic to grid-scale in a variety of forms from batteries and heat stores to different types of pumped storage. Aggregation of EES systems such as electric vehicle batteries will also become a significant 'demand side service' to the control centres responsible for balancing the smart grid. Current estimates of the impact of demand side services suggest 5% of demand may be discretionary by 2020 [12]. Adding-in the potential for around 15GW of embedded generation from technologies such as heat pumps, photovoltaic, biomass, hydro and tidal power, the complexity of grid management will require more active intervention in both transmission and distribution systems.

Consideration of 'energy storage' verses 'electrical energy storage' is also important in the contexts of energy security and security of supply. Distinction between energy storage and EES is usually not made, possibly because the focus on the topic is not oriented to view EES within energy storage as part of an energy security strategy. Energy storage however, is generic to both contexts and so it is advantageous to include some aspects of energy storage modelling within the IEC CIM as this could offer a bridge to other prime mover energy resource models. This offers opportunities to develop a holistic information model environment for energy management that is not necessarily limited to the traditional electrical domain of the IEC CIM. This is an issue that has already been observed with regard to a 'CIM for gas' but has not yet found traction within the IEC due to its scope focussing on electrical systems. It may however be a topic for supervision by the International Standards Organisation (ISO), or failing that for individual Governmental organisations to determine depending on their particular energy security strategies. In terms of energy management from an energy security perspective however, a unified model of energy resources that included coal and gas as well as electricity would be very powerful. For this

reason the opportunity was taken within the proposed CIM extension to include UML features that offer such a bridge.

6.5 Roles for EES technologies

In [209] Gopstein notes that managing energy as opposed to power will be of increasing importance as the amount of non-dispatchable generation increases. Separation of energy and power is realistic to storage technologies as they can be scaled to increase energy capacity without affecting the cost of power. In Fig. 53 some examples of common and emerging EES technologies are presented in consideration of their range of operational capacities. This simplified overview is a novel representation that aims to highlight four key parameters relating to all forms of EES that need to be accommodated by an information model used by an EMS; energy and power capacity, discharge operating envelope and responsiveness of the

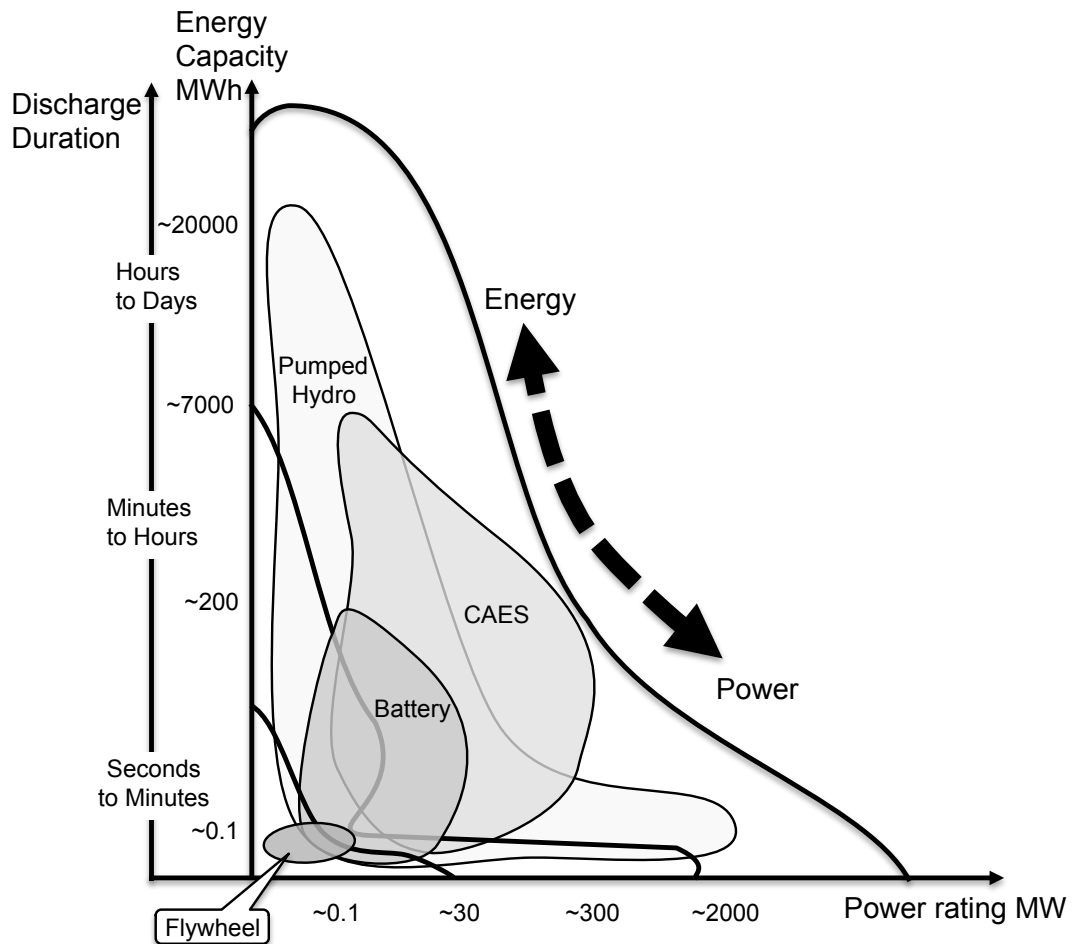

Fig. 53. Deployment characteristics of common EES technologies (not to scale).

discharge envelope. The data for constructing the graph was found in [210].

In Fig. 54 a similar classification of a wider range of ES technologies is given based on a double logarithmic scale graph seen in [203]. Estimates for Liquid Air Energy Storage (LAES) technology have been added following discussions attended by the Author between the technology developer [211] and National Grid. This graph is useful for general characterisation of available and emerging technologies as most are scalable and can be deployed in a modular manner that can increase power output or energy storage capacity. The usual constraints of cost, and in some cases geography (CAES, SYN), will apply to the scaling of these technologies in practice.

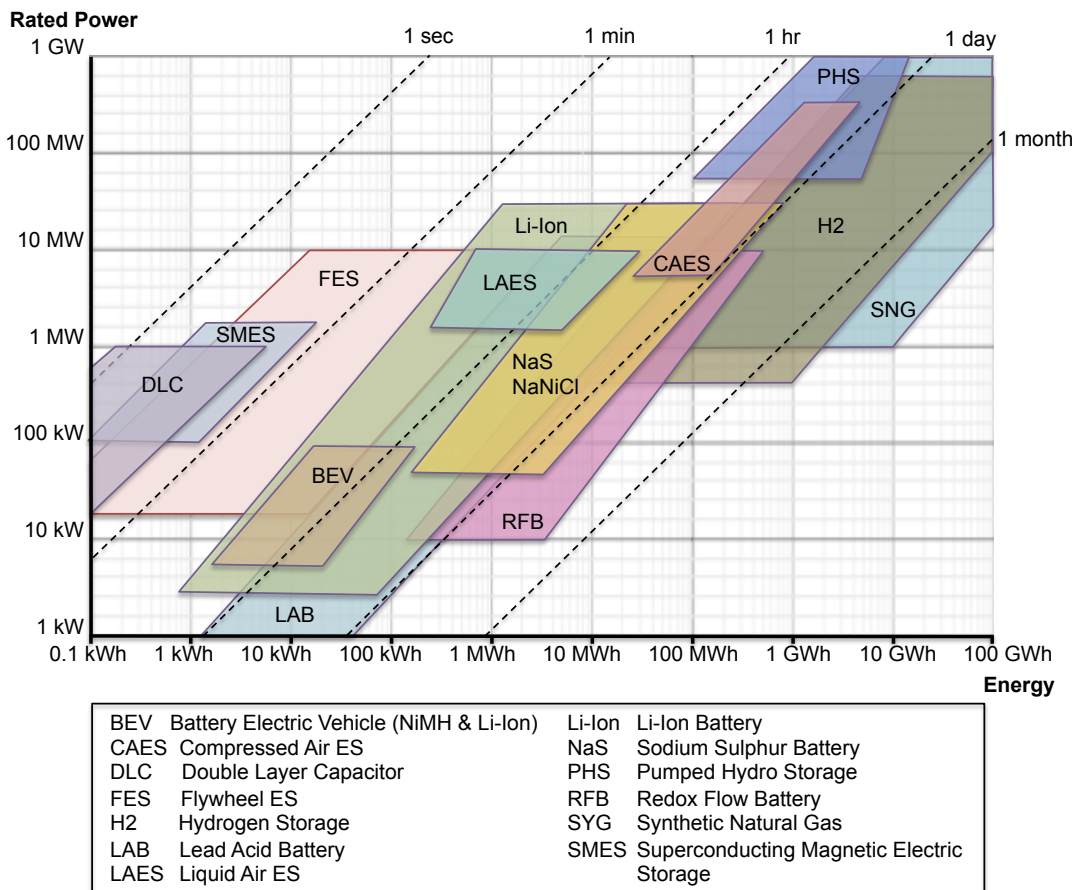

Fig. 54. Comparison of rated power, energy capacity and discharge time for different energy storage technologies.

Broadly speaking, the EES roles for the technologies presented in Fig. 53 and Fig. 54 will be reflected in the speed of response, endurance, energy and power capacity for a given technology. Due to the complexity of their potential applications, these roles will also vary depending on the perspective taken – utility, consumer, isolated user, essential service etc. From a utility control perspective some roles are presented in Table 4. to provide more background to the development of the CIM extension and to highlight how the current IEC61970 CIM standard is lacking in facilities to model grid-scale or aggregated small-scale implementations. This point will become clearer when the existing CIM UML architecture referring to energy storage is presented in Section 6.7, below. It is important to recognise in view of the emerging market and use cases for EES that their roles (as well as some of the technologies) are not yet fully mature and therefore it is prudent to make any CIM extension design flexible, scalable and as generic as possible.

In Table 4 some roles are still under development (such as for LAES, BEVs, FES) but an indication of where they could operate is given. In terms of the medium and smaller energy capacity technologies aggregated use of multiple instances of these technologies is likely.

Table 4. Established and emerging roles for different types of EES system.

Role / Technology	H2, SNG	Pumped hydro CAES¹, LAES	NaS, RFB batteries	Li-Ion, LAB batteries, BEVs	FES, SMES, DLC
Arbitrage					
Peak shaving					
Balancing					
T&D deferral					
Power quality					
Voltage stability					
Black start					
Residential storage					

1 - Includes Diabatic and Adiabatic CAES

 Market development required  Role enabled  Role N/A

6.6 Use cases for EES technologies

An understanding of the roles and use cases for different forms of energy storage systems is necessary to derive the information about them that should be modeled within the IEC CIM. Some current implementations of EES deployment will be surveyed in this section to gather the characteristics that will form attributes of the proposed extension to IEC 61970.

Storage is regarded as both a generator and a load where different technologies offer scalable and over-lapping performance influenced by cost and physical constraints. From the perspective of decarbonisation, use cases for pumped hydro, batteries and flywheel energy storage systems in the USA and Japan and their operational characteristics are presented in [204,205,206]. Examples of other recent and planned installations include the UK Power Networks 200kWh/600kW Li-Ion battery, Synchronous Var Compensator combination for wind farm voltage stability through control of real and reactive power [212]; a 4MWh/46MVA Ni-Cd battery outage support installation in Alaska [213]; a 2.5MWh/300kW cryogenic air storage and cogeneration pilot plant using waste heat in the UK [211]; a proposed 4GWh/1GW NaS battery voltage and outage support facility in Texas [214].

In general, as the penetration of renewable energy sources increases the value and utility of appropriately sized EES also increases due to its flexibility and responsiveness to network dynamics [215]. This view aligns with that of Strbac *et al* [208] who find that the value of storage is not strongly affected by increases in storage duration over 6 hours. This is likely because of the relationship to the greater predictability of the weather inside a 4 hour window. With the use of NaS battery technology to stabilize and back-up up large windfarms as a way of aligning deliverable energy with forecasts [216,217] such developments could displace the need for some thermal spinning reserve, saving the cost and emissions that would otherwise be due to operating large generators in this inefficient manner.

Fast response storage technologies like flywheels, batteries and some pumped storage, able to discharge power and recharge rapidly to follow regulation signals are deployed and under evaluation as *ancillary services* for voltage and frequency correction for power quality and stability [205,218]. Massively scaled battery installations are also being deployed for demand

support [219,220]. Batteries can also be deployed to assist in load-shifting and peak-shaving as a means to defer the high investment required to reinforce transmission and distribution lines. Arbitrage is a further use case for EES with sufficient energy capacity, presenting an attractive way to avoid costs associated with renewable energy curtailment. However the market for such operations is as yet immature in the UK.

6.7 Proposed model extension to IEC 61970 for EES

From the surveys of EES technologies, roles and use cases in Sections 6.5 – 6.6, and the implications of context from Section 6.4, it was decided to develop a generic scalable ‘platform’ within the IEC 61970 to accommodate current and future technologies. The principal characterizations of energy capacity, power capacity, responsiveness to discharge/charging and discharge/charge duty duration, corresponding to the following use cases were considered:

- Scheduled energy (dispatchable generation, outage support)
- Regulating reserve (voltage and frequency control, power quality)
- Arbitrage (load-shifting, demand support)

This selection prepared the ground for the design of the Energy Storage Model (ESM) in UML, by pointing to the requisite class objects and their attributes.

6.7.1 Current provision for energy storage within IEC 61970

The IEC CIM has a canonical structure made up of packages of UML classes. The current production release of IEC 61970-301 (Release 15) [26] is divided into 17 packages with the ‘Generation’ package comprising two sub-packages (Fig. 55). The classes within each package are structured according to UML conventions of ‘generalisation, association and aggregation’ with appropriate cardinality and multiplicity to capture the information representing the concrete (real) and abstract (conceptual) components of power system resources required for energy, asset and

market management by the network utility. Generally, the concrete classes inherit metadata from the abstract classes that contain them.

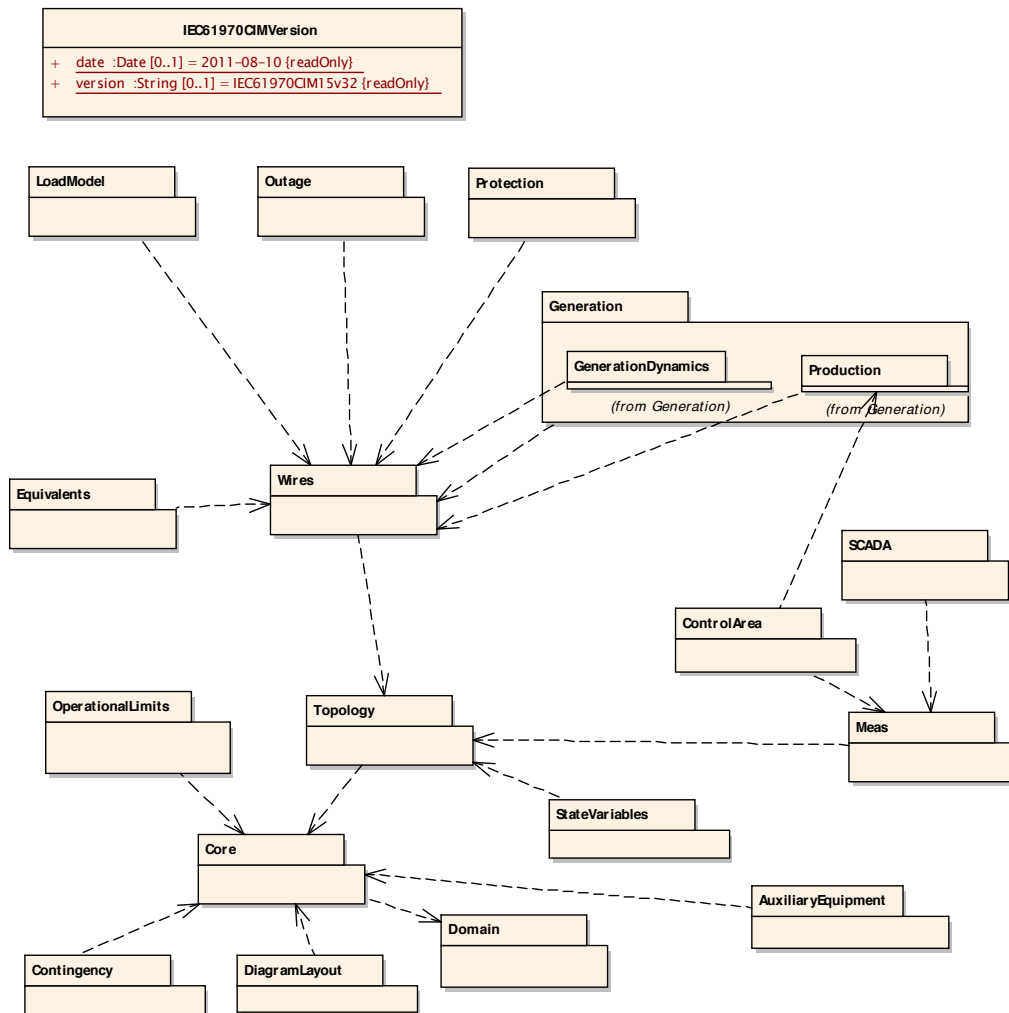

Fig. 55. IEC CIM Standard 61970-301 [26].

In the 15th release of IEC 61970, EES is represented by models for Pumped Hydro and CAES within the 'Production' sub-package, of the Generation package. The Production package contains classes that model information about different kinds of generators, including production-costing information. This is used to enable economic allocation by control centres of generating power system resources to meet demand and calculate the reserve quantities of generation capacity as well. The types of generating technologies that are included in the Generation model are Hydro, Wind, Thermal and Nuclear although only models for hydro and thermal technologies have been developed in any detail to describe parameters

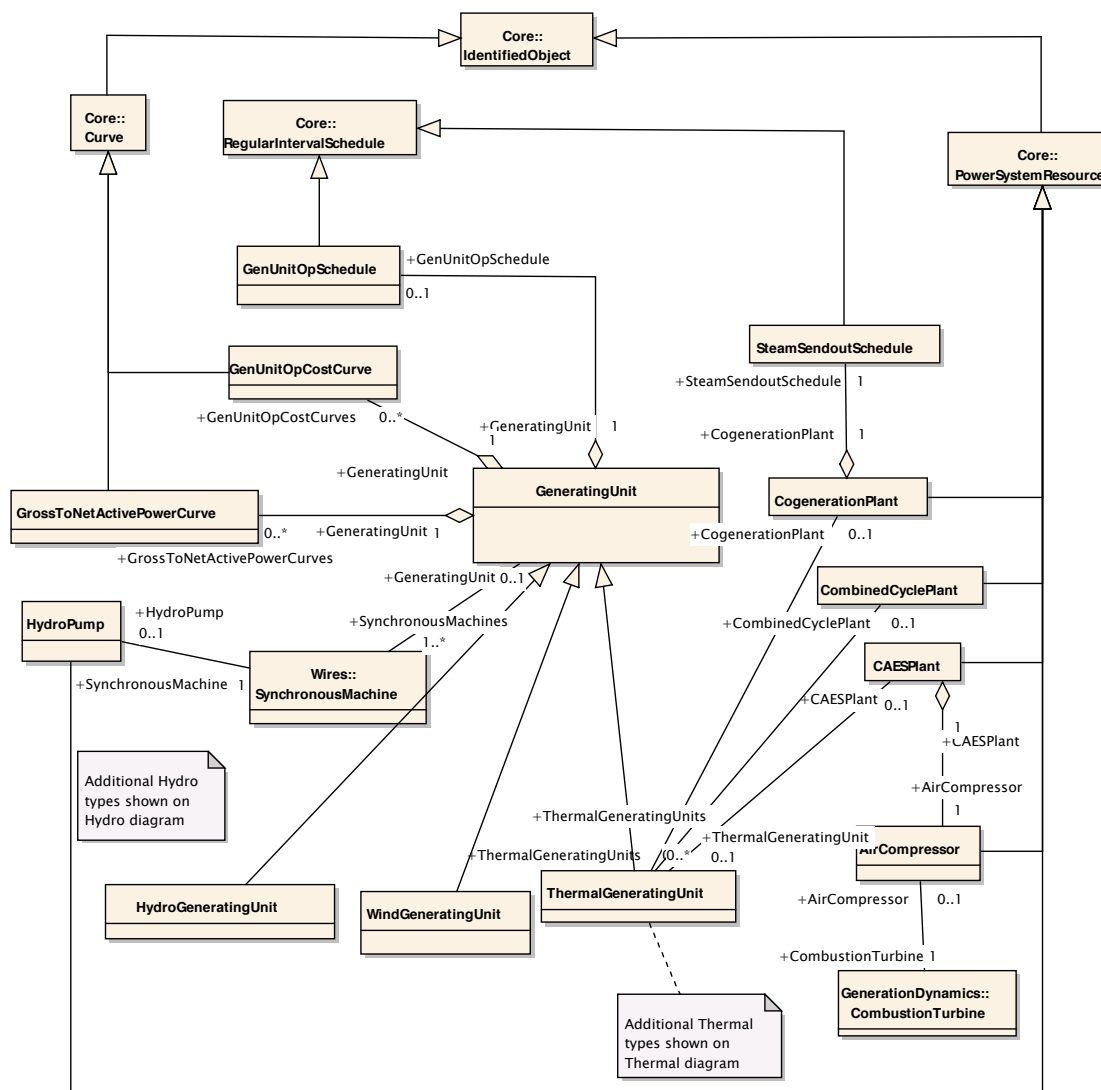

Fig. 56 Generation main model diagram [26].

relating to how the technology is operated physically. Each generating technology type model container inherits from the parent abstract “CIMGeneratingUnit” container (Fig. 56). The CIM class “CIM:CAESPlant” forms an association to the model for thermal generating technologies. It has two attributes giving the storage capacity and gross rated generation capacity of the CAES plant. Information relating to scheduling and operating the CAES plant will therefore be obtained via the associated concrete “ThermalGeneratingUnit” and general “GeneratingUnit” class models. The latter is shown in Fig. 56.

The concept of a “GeneratingUnit” within the CIM is used as an abstract container for a number of real synchronous machines in the generating mode

of operation. A “SynchronousMachine”, has a shaft rotating synchronously with the network that can also operate as a synchronous condenser or a pump. “CIM:SynchronousMachine” therefore is a concrete class.

“GeneratingUnit” generalizes a grouping of different kinds of synchronous machines that act as generators, or as a “HydroPump” for charging pumped hydro reservoirs. The “CIM:SynchronousMachine” class also generalizes to a “CIM:RotatingMachine” abstract class (found in the Wires Package) which may be used as a generator or a motor to provide for the use case of regulation of voltage and frequency. “CIM:RotatingMachine” distinguishes a “SynchronousMachine” as a piece of regulating control equipment from other regulating equipment types, described by “CIM:FrequencyConverter”, “CIM:StaticVarCompensator” and “CIM:ShuntCompensator” classes (Fig. 57).

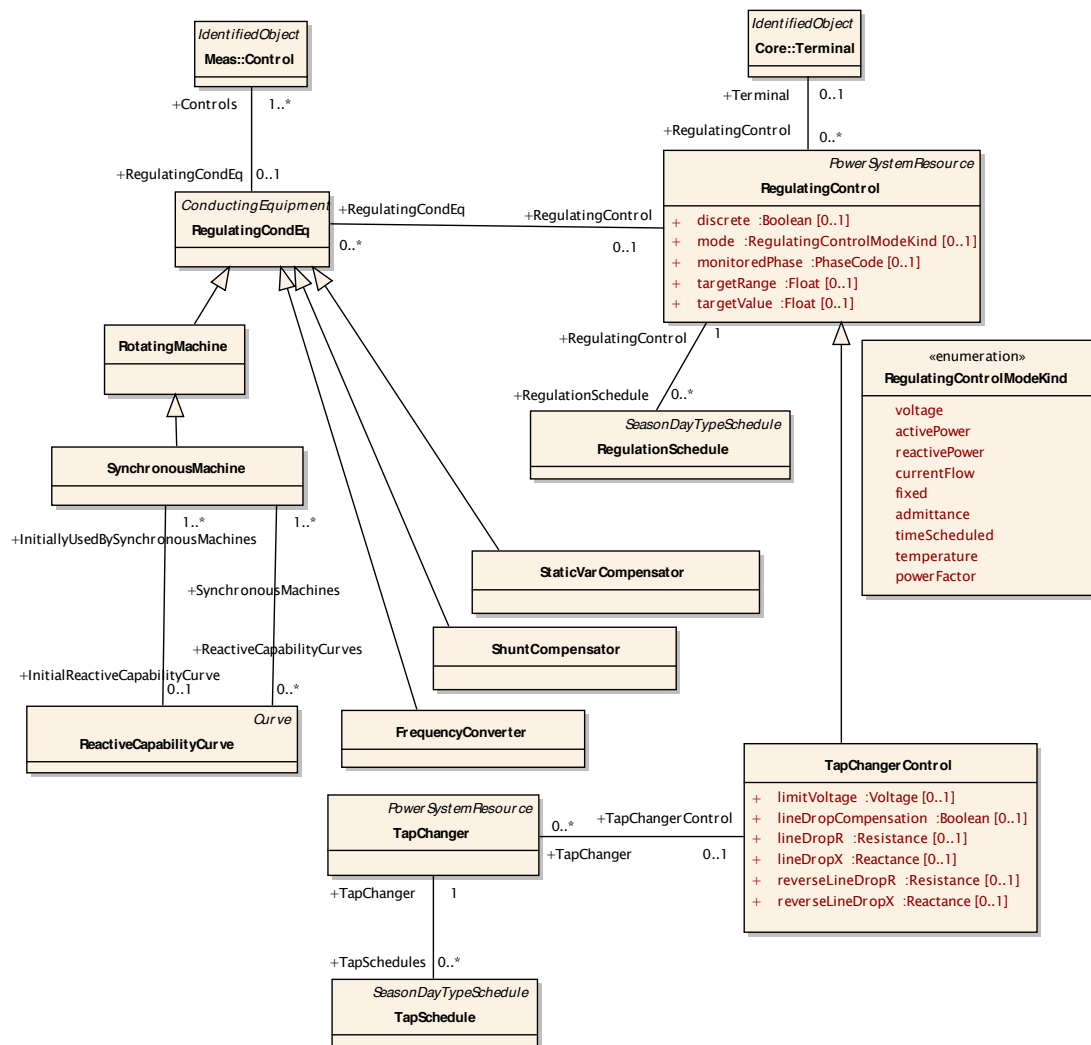

Fig. 57. Regulating equipment model from CIM 15 [26].

Observing the difference between the use of synchronous machines and the way in which other EES technologies (such as batteries and flywheels) convert energy, a new Package to act as a generic interface to the informational requirements of other forms of energy storage is proposed in view of the emerging smart grid use cases outlined above.

The proposed model reuses existing CIM UML classes and stereotypes as far as possible in order to minimize the amount of code extension to build a data model in CIM RDF XML. Concrete classes representing different battery types and flywheels were used to demonstrate the principal of the extension but are not expected to be the only technologies that could eventually be included in it. They are contained within abstract containers linked to operational data curves, generally following the stereotypes already provided by the existing models within the IEC CIM. The proposed EES UML class diagram currently presents only a few attributes and enumerations that would be required within the classes as, experience with these technologies within electrical grids is limited so far. Therefore it is expected that as use of these technologies develops further attributes would be determined as necessary.

6.7.2 Design for novel energy storage model

The Energy Storage Model (ESM) was designed in Enterprise Architect [221], the same UML modelling tool that is used to design and maintain the CIM standard. A new package of classes was developed that created a further dependency to the existing Production package (Fig. 58). The new package was necessary to contain the extension classes that were distinct enough from existing CIM classes to warrant a new modelling architecture. As energy storage serves the production of electrical energy generally, this seemed like a reasonable place to locate the extension. However it could be moved if required due to the modular nature of the CIM design. To distinguish the extension classes and attributes from members of the standard CIM, the namespace “ESM” will be used below. Some new “CIM:Datatypes” were created to define enumerated data values for the technologies represented in the new model. These included the principal battery technologies Sodium-sulphur, Lithium-ion and Vanadium-redox flow, as well as some sample

attributes for Flywheel “ESM:SpinSpeed”, using the existing “ESM:RotationSpeed” enumeration stereotype. A new attribute, “ESM:StockPile” to indicate the volume of a fossil fuel referred to by the “CIM:FuelStore” class was also created.

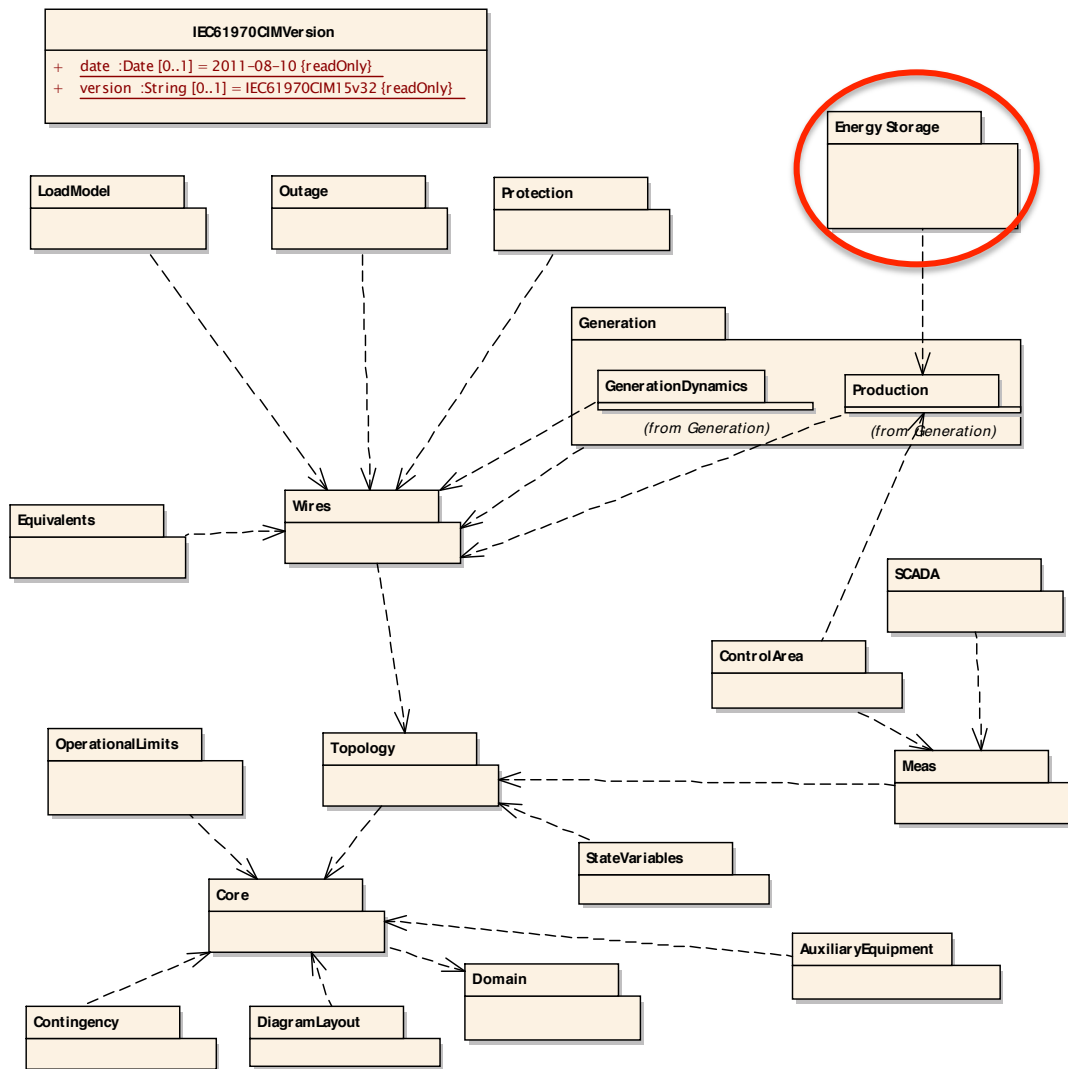

Fig. 58. CIM 15 packages showing ESM package extension.

The logic of the CIM model for pumped hydro (Fig. 59) was used as a design template informing the structure of the ESM. In this model the key feature is the “CIM:HydroPowerPlant” class which is a container for both generating and pumping (storage) modes of operation. Various other classes serve management of the storage reservoir (“CIM:Reservoir”) and schedule the mode of operation of the hydro power plant to be either storing or discharging

stored energy through the “CIM:HydroPump” and “CIM:HydroGeneratingUnit” classes respectively.

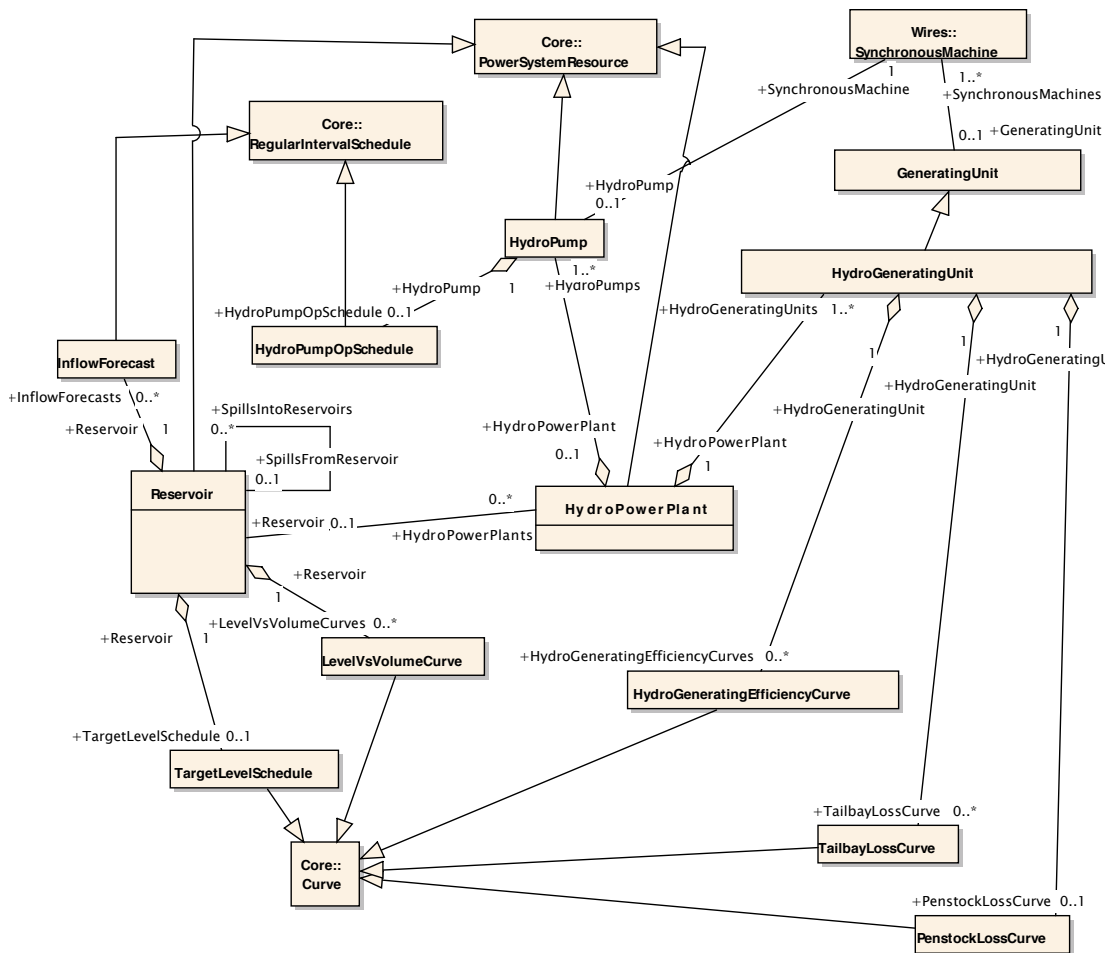

Fig. 59. Hydro and pumped hydro model from CIM 15 [26].

A description of the ESM shown in Fig. 60 now follows to explain the logic behind its design and comparisons with classes in the CIM Production Model. Underpinning and driving the design of the ESM are the two fundamental perspectives of Decarbonisation and Energy Security, described in Section 6.4.

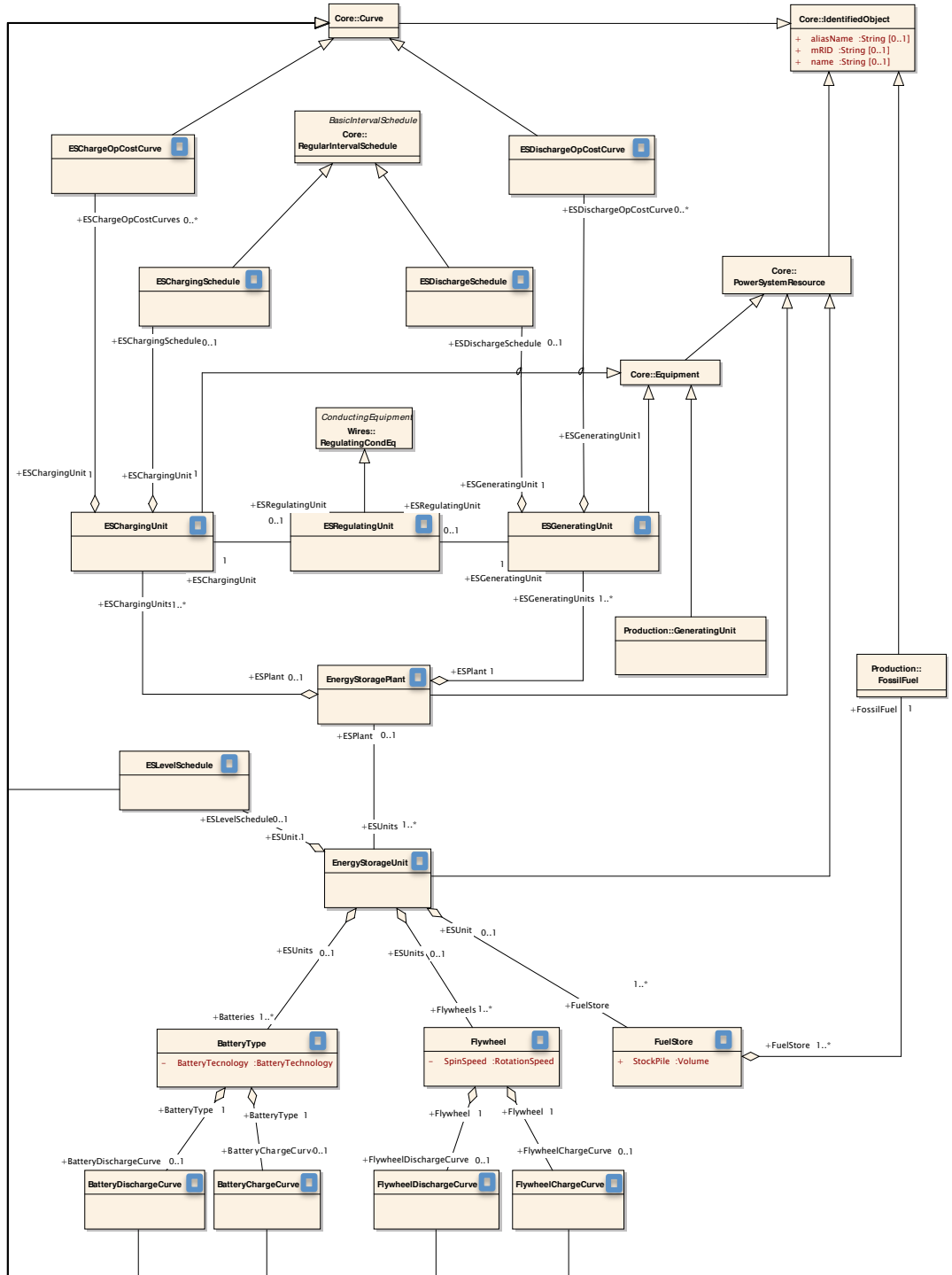



Fig. 60. Proposed ESM UML class diagram. New classes are indicated by 

A. Decarbonisation perspective

Physical storage technologies are aggregated into the “ESM:EnergyStorageUnit” container. Attributes from the individual technology in combination with curves accessed from the “ESM:ESLevelSchedule” help to determine the power and energy level status within a particular “ESM:EnergyStorageUnit” technology. These curves account for the number of duty cycles, the degree of discharge, energy leakage, electrolyte temperature (in the case of batteries) and performance degradation etc. for a given technology. This is similar to treatment given to calculating the potential energy of a hydro reservoir in the CIM Hydro Model.

The role of the “EnergyStoragePlant” class is similar to the role of “HydroPowerPlant” in the way it offers a power system resource that can be used in both generation and load modes of operation. From a network-wide perspective therefore, “ESM:EnergyStoragePlant” acts as a container for distributed energy storage units connected to different parts of the grid.

EnergyStoragePlant also aggregates equipment containers for charging and discharging stored energy through the classes “ESM:ESChargingUnit” and “ESM:ESGeneratingUnit”, which are loosely equivalent to the status of the “CIM:GeneratingUnit” class in the Production Model. This would be useful to the metering that would be required for storage technologies under different modes of operation, by clearly differentiating charging from ‘negative generation’ as is currently the way in the CIM. Details of the control equipment that manage the charging and discharging of energy stores were not modeled because they are not required for explanation of this perspective but it is assumed they would aggregate to the “ESM:ESChargingUnit” and “ESM:ESGeneratingUnit” classes.

Operating cost curves and the discharging and charging schedules, provide information about the optimum time and mode of operation for energy storage plant. The configuration of the charging and discharging schedules under the superclass “CIM:RegularIntervalSchedule” reflects the scheduled energy and arbitrage use cases stated above.

The remaining use case, concerning regulating reserve for frequency, voltage regulation and ancillary services for power quality, is addressed as

follows: Associations from the “ESM:ESChargingUnit” and “ESM:ESGeneratingUnit” classes to an “ESM:ESRegulatingUnit” class, have a multiplicity that allows EES systems to switch between charging and discharging if required by a regulation signal. This signal is derived in a similar way to other regulating equipment within the CIM Wires Model through generalization of the “ESM:ESRegulatingUnit” class to the “CIM:RegulatingCondEq” superclass. The creation of the “ESM:ESRegulatingUnit” class was necessary (and follows the analogy of the “CIM:RotatingMachine” class within the Wires Package) because the associated charging and discharging classes already generalize through the “ESM:EnergyStoragePlant” class to the “CIM:PowerSystemResource” class. Thus a general EES power system resource has now been facilitated for storage, discharge and regulation modes of operation. The “CIM:PowerSystemResource” class generalizes to the “CIM:IdentifiedObject” class to attach an identity (“CIM:mRID”) to each EES power system resource.

The IEC CIM modelling convention conforms to only singular generalizations from one class to another. Generalizing of the “ESM:ESRegulatingUnit” in this way, effectively makes available the charging and discharging capabilities of emerging energy storage plant alongside rotating machines, static VAr compensators, shunt compensators and frequency converting equipment, adding another tool for regulation purposes. Economic operation of EES power system resources requires their cost curves. These are derived through generalisation of charging and generating functions to “CIM:Curve” via aggregations to “ESM:ESChargOpCostCurve” and “ESM:ESDischargeOpCostCurve” classes. The function of these classes, like their extant equivalent in the CIM (“CIM:GenUnitOpCostCurve”), gives a measure of the performance in generation and charging mode against the cost of the electricity required to carry out these functions at a given time.

The ESM described above has been developed as a generic information interface for the use cases of battery and flywheel energy storage technologies but it offers an extensible information architecture to accommodate other forms of EES technology such as SMES and supercapacitors when warranted. Classes representing these technologies would be aggregated to the “ESM:EnergyStorageUnit” class with their own

sets of curves and classes for any ancillary equipment. Attributes particular to a given storage technology in addition to the ones presented would also be required to meet the information requirements of control centre power system applications.

B. Energy Security perspective

The “CIM:Reservoir” class within the Hydro Model is implicitly an example of a fuel store but this approach needs extension to address energy security use cases, especially as primary fuel supply lines can no longer be assured with increasing dependence on imports and diminishing global reserves. Consideration must be given to the scope of *energy security* in order to justify the level of detail in the information model for a given use case. For example, it could be extended to include all known accessible reserves of a particular fuel type, or to extracted reserves held in the stockpiles in a geographic region (“CIM:GeographicalRegion”, “CIM:SubGeographicalRegion”), or to the stockpiles of fuels on-site at the points of conversion to electrical energy belonging to generation companies.

The inclusion of the class “ESM:FuelStore” in Fig. 60 is intended to reflect the quantity of stored energy in stockpiles of fuels used by thermal generators. It could also be developed with appropriate “ESM:Enumeration” to reflect novel kinds of fuel store containing SynGas and Hydrogen. This is an attempt to address part of the scope of energy security. The “ESM:FuelStore” class could also be a container associated to classes reflecting the greater geographical spatial scopes for energy security mentioned above (“CIM:GeographicalRegion” etc). In doing so, information relating to the natural resources and environmental services of a particular geographic region could be modelled. This may be considered to be beyond the intended scope of the IEC CIM, but is a necessary part of a national energy security strategy.

The class object “CIM:FossilFuel” from CIM15, aggregates to “ESM:FuelStore” to carry values of specific heat content for coal, gas, oil and lignite. Types of fossil fuel (“CIM:fossilFuelType”) are existing enumerations used by the “CIM:FossilFuel” class. Thus the energy content of the fuel store can be calculated within the ESM from the combination of the attributes for

the amount of fuel (“ESM:StockPile :Volume”) and attributes (including “CIM:fuelHeatContent”) from the “CIM:FossilFuel” class.

“ESM:FuelStore” aggregates to “ESM:EnergyStorageUnit”, which generalizes to “CIM:PowerSystemResource”, presenting a logical information pathway to report the available energy within fuel stores accessible to thermal generating units connected to the grid, thus supporting the planning of reserves to the energy supply (Energy Security use case). As the ESM is designed to address issues associated with energy security, it is recommended that the Production Model Datatypes enumerations for “CIM:FuelType” be extended to include biomass, as it is already being consumed in thermal power stations. This would enable better definition and more realistic knowledge representation of fuel consumption within co-fired power stations. Biomass is also likely to form an increasingly significant part of sustainable energy strategies in future.

As mentioned in Section 6.4 the need to address interoperability use cases for energy storage systems and other prime mover fuel types now extends beyond the current scope within the IEC CIM. With the inclusion of the “ESM:FuelStore” class within this novel EES information model a potential bridging point to other information models has been created.

6.8 Further work

The ESM requires the addition of further enumerations and Datatypes as attributes to describe the information requirements of the modeled energy storage systems. There is also a need to investigate the information modeling of distributed energy storage systems that will be embedded within future distribution networks. This could involve the relationship of the IEC 61850 substation automation information standard to IEC 61970. It is also part of the EPRI involvement in standards activities within the US Government Priority Action Plans (PAP 7) to which the above ESM has been given recognition [222]. The counterpart relationship between the use cases for grid-scale energy storage and grid-scale demand reduction management also warrants further investigation from an information modeling point of view.

6.9 Chapter summary

This Chapter went deeper into describing some of the specific reasons for the stochastic, environmentally dominated nature of the emerging smart grid. Such a scenario is developing as the proportion of renewable energy technologies used for generation to decarbonise our electricity supply increases as well as to address concerns over energy security in times of increasing competition for traditional fossil fuels. Balancing the future smart grid will also need to account for more dynamic load profiles. The use of energy storage systems is seen as a promising means of decoupling the immediacy of the 'supply-demand process chain' by introducing the opportunity to absorb energy when there is a surplus in generation and discharge it back to the grid at times it is required for a variety of use cases. This will give greater flexibility to the grid as a whole but is differentiated by the operational characteristics of the various forms of energy storage technologies under consideration. These characteristics and the roles that EES technology use cases can play were then presented. Key aspects of EES technologies that would be modelled within a generic CIM extension included speed of response, endurance, energy and power capacities. The distinction between electrical energy storage systems and energy storage per se was also highlighted in view of the opportunity for a holistic approach to manage stored energy. Different perspectives can therefore be applied to the use of stored energy and capturing these was one of the aims of developing the proposed extension to the IEC CIM.

This work was motivated by the recommendation from the IEC TC57 for the need to develop standards relating to EES technology as deployment ramps-up. Inspection of current CIM standards identified a gap in IEC 61970 for handling their informational requirements as part of the anticipated integrated information requirements of utility control centres. A detailed analysis of CIM 15 was made and an ESM based on the design template of the extant hydro model was presented. This model, as a separate Package of UML classes, re-used existing CIM classes and process organisation (as a design template) to create a generic platform for the integration of emerging EES technologies. It also enabled the potential to utilise information about available stored and stock-piled energy reserves to address the energy

security perspective. The latter could potentially also offer a bridge to other information models concerned with different fuel vectors such as a CIM for gas.

This novel ESM for the IEC CIM has been presented to IEC TC57 members from Working Groups 13, 14 and 19 at a recent international CIM Users group meeting (New Orleans, Oct 2012) and acknowledged by EPRI as a contribution to their ongoing project to develop a wider model encompassing DERs that will address not only grid-scale energy storage systems.

CHAPTER 7

CONCLUSIONS AND FURTHER WORK

7.1 Conclusions

The IEC CIM can be used in support of three essential smart grid use cases as described in Section 2.7. These include a PSA information interface mapping standard; an enterprise semantic model to support information integration; an ontology for smart grid knowledge representation. This thesis has reached beyond current paradigms to present work in Chapters 3 to 6 that addresses these use cases and responds to the opportunities to extend CIM application as laid out on Pages 51-53. It has also presented practical applications of CIM deployment with these in mind.

7.1.1 Novel EIM strategies for National Grid

Enhanced coordination of CIM roll-out at National Grid: Chapter 3 described a foundation for the successful implementation of the CIM within a power utility a new transmission Information Management Framework was designed to give context and guidance to the management of further CIM implementation at National Grid. This was followed by a novel Ten-Step CIM implementation plan that capitalised on reusable design processes to meet an incremental development of interoperability within the utility.

To give direction to this implementation of the CIM a novel conceptual high-level SOA was presented that outlined how the development of interoperability could be visualised beyond utility boundaries to link National Grid informational requirements with those of its customers and regional service centre, Coreso. This scalable architecture meets the vision of the future smart grid for Enterprise-to-Enterprise interoperability to provide secure operation, situational awareness and network flexibility over increasingly wider areas than has hitherto been possible due to a lack of information interoperability.

7.1.2 A secure cloud computing infrastructure solution

Trusted cloud infrastructure utilising the CIM-based model exchange: Chapter 4 presented the concept of a risk-constrained, cost-optimised operational envelope as the real time objective of the TSO. It was proposed that cloud computing technologies could be employed to address not only the pattern of data processing and storage required but also the need for secure and trustworthy access to data and applications deployed within the cloud.

In collaboration with other research teams from University of Oxford and Open Grid Systems, a novel trusted cloud computing infrastructure was built and demonstrated for a TSO-DNO model exchange use case.

7.1.3 Design methodology and demonstration of a metamodel repository

The use of multiple XML namespaces in CIM-based smart grid knowledge representation: Chapter 5 presented a novel foundation for understanding how PSA data models contribute to utility business intelligence and operational support of the emerging smart grid. A novel centralised model naming and identity management process architecture was presented in line with the current practice of restricting the use of the CIM to a single XML namespace. However on further analysis of the CIM 15 naming architecture it was argued that the real limiting factor to effective name and identity management where multiple model exchange and merging use cases are concerned, is the practice of imposing a single CIM XML namespace.

Following this, a novel methodology that fully exploited the value of RDF and XML 'technologies' was presented in the form of a CIM metadata model repository that could form the hub of a NMMS as well as serve as a knowledge resource for wider utility business processes. It was then demonstrated to address real TSO information exchange use cases. The alignment of operational online with operational offline representations of the electrical power network was chosen as the focus of the demonstration to show the importance of this application in supporting an enhanced understanding and awareness of grid reality as well as an approach to a 'single version of the truth' scenario.

7.1.4 Extension of IEC 61970 for electricity storage modelling

The need to model information concerning EES and energy security awareness: Chapter 6 focused on the issue of balancing supply and demand under stochastic operating conditions. It acknowledges the IEC TC 57 call for further IEC standards to address emerging EES technologies and the mounting evidence of its deployment in service of smart grid balancing, power quality and security. A novel information model within a package of UML classes that can serve as a generic interface to the rest of the CIM was then designed and presented as an extension of CIM 15. It followed the design principles of the extant hydro model but is more flexible in the sense that it can accommodate new forms of EES technology as they are implemented.

In addition provision was made within the extension to address energy security as well as decarbonisation prerogatives by the introduction of a new CIM class to enable calculation of the energy capacity of primary fuel deposits. It was proposed that this feature could contribute to a holistic information model of regional energy reserves as well as act as a bridge to the information model of other fuel types, such as a CIM for gas.

7.2 Further work

The wide spread of issues addressed within this thesis offer several opportunities to further the work presented by extension, demonstration and development.

7.2.1 Utility information exchange through the cloud

The work presented in Chapters 3 and 4 lends itself to demonstration and development to address more use cases for information exchange. In and of itself the principles behind the development of a secure cloud computing platform remain unchanged but the infrastructure can be enhanced to log and evaluate exchanged data in order to improve the provenance of the service. In addition other services could be developed for deployment in the cloud to address the most common and reusable requirements of pan-utility data management and analysis. The 'Grid-user' data service presented in

Chapters 3 and 4 (see Fig. 30) is an example of this application that could be developed incrementally, on top of a trusted cloud infrastructure.

The future of smart grid data processing and knowledge development may lie in shared trusted cloud infrastructures and follow a model of application management by vendors who directly manage versions of their applications in the cloud that are accessible by licensed utility customers. Demonstration of these methods has happened in non-critical applications but given the increasing level of data processing required to control and optimise the future smart grid, further investigation and demonstration of this business model is recommended for the electrical power industry.

7.2.2 Metamodel repository

The use of a metamodel repository within NMMSs and as a business intelligence resource is the focus of the work presented in Chapter 5. A detailed discussion of further work was also given at the end of the Chapter in Section 5.8. This described three key directions in which further work could take place, including:

- Automation of some of the manual processes to identify and rotate the values of object mRIDs.
- The addition of version management mechanisms for recording the import and export of models into and out of the repository.
- The development of a layered SOA that extends the knowledge base within the repository into business systems for the purpose of developing business intelligence supporting decisions and actions (Fig. 31).

Perhaps the most pressing technical challenge to make the methodology presented serviceable to an industrial application would be attention paid to version and subversion management in order to control access privileges and change controls over the make up of the repository as a knowledge base. This would be possible as was already mentioned by deploying a COTS version management solution of which there are several potential candidates to explore.

Following this it would be helpful to work with the model-handling tool vendor to develop more automated alignment processing of new models admitted to the repository composite model. This would involve aspects of semantic and pattern recognition intelligent processes as has already been outlined in Chapter 5. The process could be assisted by semantic annotation of the CIM metadata model that may lead to some extension of the IEC standard to achieve this.

Demonstration of the repository as a knowledge resource base for advanced situational awareness using novel combinations of metadata from the combined metamodel contributions would be another potential development project. And a study of the relative merit of using the repository approach to online and offline model alignment compared with current manual practices laboriously employing NASAP codes would confirm the business case for investment by National Grid in the proposed solution.

7.2.3 IEC CIM extension – energy storage modelling

Chapter 6 presented the rationale and design of a novel metamodel for energy storage as an extension to current IEC CIM capabilities. The opportunity exists for further testing and development of this model under simulated conditions by developing a suitable network data model to convert to a CIM metadata model. However the real benefit will only become clearer when this can be deployed in a real context to determine if the model logic is robust.

Another promising opportunity lies with the need to explore development of a similar CIM for energy control centre use with gas. Several of the design principles behind the IEC CIM could be applied to a CIM for gas, building on the work already started in other utilities (such as National Grid and SEMPRA). The link developed in the EES CIM extension to model available energy reserve capacities in the gas energy vector could then theoretically be exploited until it was recognised as a practical requirement by multi-energy utilities like National Grid.

Further collaboration with EPRI is also recommended to see how the EES model presented could be integrated within a wider CIM for DER model according to their work stream under PAP 7.

REFERENCES

- [1] Pacific Northwest National Laboratory, US Department of Energy, "Gridwise[®] Architecture Tenets and Illustrations", PNNL-SA-39480, 2003.
- [2] Object Management Group, "*MDA Guide*", OMG, document omg/03-06-01. 2003. *Version 1.0.1*.
- [3] E. Seidewitz, "What models mean," *Software, IEEE*, vol. 20, pp. 26-32, 2003.
- [4] G. Guizzardi, "Ontological foundations for structural conceptual models", CTIT PhD Thesis, 2005. Series No. 05-74, Enschede, The Netherlands.
- [5] T. Kühne, "Matters of (Meta-) Modeling", *Software and Systems Modeling*, Volume 5, Number 4, pp.369-385, 2006.
- [6] T. R. Gruber, "A Translation Approach to Portable Ontology Specifications," *Knowledge Acquisition*, vol. 5, pp. 199-220, JUN 1993, 1993.
- [7] HM Government, Department of Trade and Industry, "Meeting the Energy Challenge A White Paper on Energy", 2007, UK.
- [8] HM Government, "Climate Change Act 2008", 2008, HMSO, UK.
- [9] HM Government, Department of Energy and Climate Change, "The UK Low Carbon Transition Plan, National strategy for climate and energy", 2009, TSO, UK.
- [10] HM Government, Department of Energy and Climate Change, "UK Renewable Energy Roadmap", 2011, DECC, UK.
- [11] National Grid, "UK Future Energy Scenarios 2012", 2012. Energy Strategy and Policy, National Grid, UK.
- [12] National Grid, "Operating the Electricity Transmission Networks in 2020", Update: 2011, National Grid plc. UK
- [13] National Grid, "Operating the Electricity Transmission Networks in 2020", Initial Consultation: 2009, National Grid, UK.
- [14] European Commission, "A Roadmap for moving to a competitive low carbon economy in 2050", COM(2011) 112 final, 2011. European Commission, Belgium.

- [15] European Commission, “Energy Roadmap 2050”, COM(2011) 885/2, 2011. European Commission, Belgium.
- [16] ENTSOE, “Ten-year Development Plan”, 2012. ENTSOE, Belgium.
- [17] Coreso, 2013 [Online] Available: <http://www.coreso.eu>
- [18] Transmission System Operator Security Cooperation, 2013. [Online] Available: <http://www.tso-security-cooperation.net/en/index.htm>
- [19] Energy and Climate Change Select Committee, “Energy and Climate Change – Fourth Report: Electricity Market Reform”, 2011, Parliament, UK. [Online] Available: <http://www.publications.parliament.uk/pa/cm201012/cmselect/cmenergy/742/74202.htm#evidence>
- [20] Federal Energy Regulatory Commission, “Integration of Variable Energy Resources”, 2012. [Docket No. RM10-11-000; Order No. 764], FERC, USA.
- [21] P. Bolton, “Energy Imports and Exports”, 2013. House of Commons Library, Standard Note SN/SG/4046
- [22] “Gas Storage”, 2009. House of Commons Library, Standard Note SN/SC/5010.
- [23] S. Jones, “Russia and the West”, 2009. House of Commons Library, Research Paper 09/36, p102.
- [24] Ofgem, “RIIO – a new way to regulate energy networks”, 2010. Factsheet 93, Ofgem, UK.
- [25] Electricity Networks Strategy Group, “Major projects status update for electricity transmission”, 2013. ENSG. [Online] Available: https://www.gov.uk/government/uploads/system/uploads/attachment_data/file/153687/major_project_status_update_march_2013.pdf
- [26] CIM Users Group, “iec61970cim15v33_iec61968cim11v13_iec6232501v07” [Online]. Available: <http://cimug.ucaiug.org/CIM%20Model%20Releases/Foms/AllItems.aspx>
- [27] A. Banerjee, K. K. Venkatasubramanian, T. Mukherjee and S. K. S. Gupta, “Ensuring Safety, Security, and Sustainability of Mission-Critical Cyber-Physical Systems,” *Proceedings of the IEEE*, vol. 100, pp. 283-299, 2012.

- [28] I. A. Hiskens, "What's smart about the smart grid?" in *Design Automation Conference (DAC), 2010 47th ACM/IEEE*, 2010, pp. 937-939.
- [29] HM Government, Department of Energy and Climate Change, "Written Ministerial statement by Edward Davey: Smart Metering", GOV.UK, 2013. [Online] Available: <https://www.gov.uk/government/speeches/written-ministerial-statement-by-edward-davey-smart-metering>
- [30] J. Gao, Y. Xiao, J. Liu, W. Liang and C. L. P. Chen, "A survey of communication/networking in Smart Grids," *Future Generation Comput. Syst.*, vol. 28, pp. 391-404, 2, 2012.
- [31] H. E. Brown, S. Suryanarayanan and G. T. Heydt, "Some Characteristics of Emerging Distribution Systems Considering the Smart Grid Initiative," *The Electricity Journal*, vol. 23, pp. 64-75, 6, 2010.
- [32] S. M. Amin and B. F. Wollenberg, "Toward a smart grid: power delivery for the 21st century," *Power and Energy Magazine, IEEE*, vol. 3, pp. 34-41, 2005.
- [33] US Department of Energy, "Grid 2030: A National Vision for Electricity's Second 100 Years", Department of Energy Office of Electric Transmission and Distribution, 2003.
- [34] Electric Power Research Institute, "IntelliGrid – Program 161", Research Portfolio, 2013.
- [35] German Commission for electrical, Electronic & Information Technologies of DIN (DKE), "The German Roadmap: E-Energy/Smart Grid", VDE, 2010.
- [36] Electricity Networks Strategy Group, "A Smart Grid Routemap", ENSG, 2010.
- [37] European Electricity Grid Initiative, "European Electricity Grid Initiative and Implementation Plan", Version V2, EEGI, 2010.
- [38] European Network of Transmission System Operators for Electricity, "European Grid Towards 2020 Challenges and Beyond" Research and Development Plan, 2010. Ed. 1.
- [39] M. Hashmi, S. Hanninen and K. Maki, "Survey of smart grid concepts, architectures, and technological demonstrations worldwide," in *Innovative Smart Grid Technologies (ISGT Latin America), 2011 IEEE PES Conference on*, 2011, pp. 1-7.

- [40] European Commission, "Standardization Mandate to European Standardisation Organisations (ESOs) to support European Smart Grid Deployment", Directorate-General for Energy, 2011. M/490.
- [41] G. F. Reed, P. A. Philip, A. Barchowsky, C. J. Lippert and A. R. Sparacino, "Sample survey of smart grid approaches and technology gap analysis," in *Innovative Smart Grid Technologies Conference Europe (ISGT Europe), 2010 IEEE PES*, 2010, pp. 1-10.
- [42] National Institute of Standards and Technology, "NIST Framework and Roadmap for Smart Grid Interoperability Standards", Office of the National Coordinator for Smart Grid Interoperability, 2012. Release 2.0.
- [43] Smart Grid-Coordination Group, "Smart Grid Reference Architecture", CEN-CENELEC-ETSI, 2012. v3.
- [44] GridWise Architecture Council, "GridWise® Interoperability Context Setting Framework", 2008.
- [45] C. Ivanov and D. Chury, "European electric power system on the way towards implementation of CIM based data exchange format," in *Power & Energy Society General Meeting, 2009. PES '09. IEEE*, 2009, pp. 1-5.
- [46] R. Ambrosio and S. Widergren, "A framework for addressing interoperability issues," in *Power Engineering Society General Meeting, 2007. IEEE*, 2007, pp. 1-5.
- [47] A. Tolk, "Architecture constraints for interoperability and composability in a smart grid," in *Power and Energy Society General Meeting, 2010 IEEE*, 2010, pp. 1-5.
- [48] E. H. Page, R. Briggs, and J. A. Tufarolo, "Toward a Family of Maturity Models for the Simulation Interconnection Problem". In Proceedings of the Spring Simulation Interoperability Workshop, IEEE Computer Society, Washington, DC, 2004.
- [49] J. Ralyté, M. A. Jeusfeld, P. Backlund, H. Kühn and N. Arni-Bloch, "A knowledge-based approach to manage information systems interoperability," *Inf Syst*, vol. 33, pp. 754-784, 0, 2008.
- [50] C. Hug, A. Front, D. Rieu and B. Henderson-Sellers, "A method to build information systems engineering process metamodels," *J. Syst. Software*, vol. 82, pp. 1730-1742, 10, 2009.
- [51] Joint Working Group on Standards for Smart Grids, "Final Report of the JWG on Standards for Smart Grids", CEN-CENELEC-ETSI, 2011.

- [52] J. P. Britton and A. N. deVos, "CIM-based standards and CIM evolution," *Power Systems, IEEE Transactions on*, vol. 20, pp. 758-764, 2005.
- [53] T. Freund and P. Niblett, "ESB interoperability standards", IBM Corporation, 2008.
- [54] M. Colan, "Service Oriented Architecture expands the vision of Web services", IBM, 2004. Part 1.
<http://www.ibm.com/developerworks/library/ws-soaintro.html>
- [55] R. Soley, "Service oriented architecture: Making the leap, leveraging model driven architecture and achieving software agility with BPM, SOA and MDA®," in *Software Engineering, 2008. ASWEC 2008. 19th Australian Conference on*, 2008, pp. 32-34.
- [56] K. Balasubramanian, A. Gokhale, G. Karsai, J. Sztipanovits and S. Neema, "Developing applications using model-driven design environments," *Computer*, vol. 39, pp. 33-40, 2006.
- [57] A. W. McMorran, G. W. Ault, I. M. Elders, C. E. T. Foote, G. M. Burt and J. R. McDonald, "Translating CIM XML power system data to a proprietary format for system simulation," *Power Systems, IEEE Transactions on*, vol. 19, pp. 229-235, 2004.
- [58] A. W. McMorran, G. W. Ault, C. Morgan, I. M. Elders and J. R. McDonald, "A common information model (CIM) toolkit framework implemented in Java," *Power Systems, IEEE Transactions on*, vol. 21, pp. 194-201, 2006.
- [59] J. Z. Cao, H. J. Zhou, Y. Z. Tang and C. X. Guo, "Realization of electric power enterprise application integration based on service oriented architecture," in *Power and Energy Society General Meeting, 2010 IEEE*, 2010, pp. 1-5.
- [60] R. Khare, M. Khadem, S. Moorthy, K. Methaprayoon and Jun Zhu, "Patterns and practices for CIM applications," in *Power and Energy Society General Meeting, 2011 IEEE*, 2011, pp. 1-8.
- [61] S. Rohjans, M. Uslar and H. Juergen Appelrath, "OPC UA and CIM: Semantics for the smart grid," in *Transmission and Distribution Conference and Exposition, 2010 IEEE PES*, 2010, pp. 1-8.
- [62] Open Platform for Communications Unified Architecture, 2013. [Online] Available:
https://www.opcfoundation.org/Default.aspx/01_about/UA.asp?MID=AboutOPC

- [63] S. A. Neumann and T. D. Nielsen, "CIM interoperability challenges," in *Power and Energy Society General Meeting, 2010 IEEE*, 2010, pp. 1-5.
- [64] D. Becker and T. L. Saxton, "CIM standard for model exchange between planning and operations," in *Power and Energy Society General Meeting - Conversion and Delivery of Electrical Energy in the 21st Century, 2008 IEEE*, 2008, pp. 1-5.
- [65] E. Lambert, "CDPSM: Common distribution power system model: When, why, what, how, who?" in *Power Systems Conference and Exposition (PSCE), 2011 IEEE/PES*, 2011, pp. 1-10.
- [66] International Electrotechnical Commission, "Energy management system application program interface (EMS- API) - Part 301: Common Information Model (CIM) Base", IEC, 2003, Edition 1.0
- [67] Electric Power Research Institute, "Guidelines for Control Center Application Program Interfaces, Technical Report", EPRI, 1996. [Online] Available: http://my.epri.com/portal/server.pt?Abstract_id=TR-106324
- [68] S. T. Lee, "The EPRI common information model for operation and planning," in *Power Engineering Society Summer Meeting, 1999. IEEE*, 1999, pp. 866-871 vol.2.
- [69] Y. Pradeep, P. Seshuraju, S. A. Khaparde, V. S. Warriar and S. Cherian, "CIM and IEC 61850 integration issues: Application to power systems," in *Power & Energy Society General Meeting, 2009. PES '09. IEEE*, 2009, pp. 1-6.
- [70] A. de Vos and C. T. Rowbotham, "Knowledge representation for power system modelling," in *Power Industry Computer Applications, 2001. PICA 2001. Innovative Computing for Power - Electric Energy Meets the Market. 22nd IEEE Power Engineering Society International Conference on*, 2001, pp. 50-56.
- [71] A. De Vos, S. E. Widergren and J. Zhu, "XML for CIM model exchange," in *Power Industry Computer Applications, 2001. PICA 2001. Innovative Computing for Power - Electric Energy Meets the Market. 22nd IEEE Power Engineering Society International Conference on*, 2001, pp. 31-37.
- [72] Strategic Group on Smart Grid (SG3), "Recommendation S-DA-2", IEC Standardisation Management Board (SMB) meeting Denver, 2009. In IEC SMB Meeting 137, Geneva, Report of, 2010.
- [73] World Wide Web Consortium, "Resource Description Framework (RDF): Concepts and Abstract Syntax", W3C Recommendation, 2004. [Online] Available: www.w3.org/TR/rdf-concepts/#dfn-blank-node

- [74] T. D. Oyetoyan, R. Conradi and K. Sand, "Initial survey of smart grid activities in the norwegian energy sector - use cases, industrial challenges and implications for research," in *Software Engineering for the Smart Grid (SE4SG), 2012 International Workshop on*, 2012, pp. 34-37.
- [75] Electric Power Research Institute, "IntelliGrid Methodology for Developing Requirements for Energy Systems", IEC PAS 62559, 2008. Ed.1.
- [76] Smart Grid-Coordination Group, "Use Case Description", CEN CENELEC ETSI, 2011. Draft, Version 0.55.
- [77] Electric Power Research Institute, "Use Case Repository", Smart Grid Resource Center, 2013. [Online] Available: <http://smartgrid.epri.com/Repository/Repository.aspx>
- [78] National Institute of Standards and Technology, "IKB Use Cases", NIST, 2012. [Online] Available: <http://collaborate.nist.gov/twiki-sggrid/bin/view/SmartGrid/IKBUseCases>
- [79] National Institute of Standards and Technology, "NIST Framework and Roadmap for Smart Grid Interoperability Standards", Office of the National Coordinator for Smart Grid Interoperability, 2010. Release 1.0.
- [80] International Electrotechnical Commission, "IEC Smart Grid Standardisation Roadmap", SMB Smart Grid Strategic Group (SG3), 2010. Ed. 1.
- [81] International Electrotechnical Commission, "IEC 62357: TC 57 Architecture; Reference Architecture for Power System Information Exchange", 2011. Part 1, Second Edition Draft, Revision 6.
- [82] S. Rohjans, M. Uslar, R. Bleiker, J. González, M. Specht, T. Suding and T. Weidelt, "Survey of smart grid standardization studies and recommendations," in *Smart Grid Communications (SmartGridComm), 2010 First IEEE International Conference on*, 2010, pp. 583-588.
- [83] International Electrotechnical Commission, "IEC 61400-25, Wind turbines – Communications for monitoring and control of wind power plants", IEC, 2006. Edition 1.0
- [84] International Electrotechnical Commission, "Project IEC 62056-6, Electricity metering data exchange – The DLMS/COSEM suite", IEC, 2013, Final Draft. Edition 1.0
- [85] M. Uslar, S. Rohjans, R. Bleiker, J. González, M. Specht, T. Suding and T. Weidelt, "Survey of smart grid standardization studies and

recommendations — part 2," in *Innovative Smart Grid Technologies Conference Europe (ISGT Europe), 2010 IEEE PES*, 2010, pp. 1-6.

- [86] International Electrotechnical Commission, "IEC 62357-1: TC 57 Architecture; Reference Architecture for Power System Information Exchange", Part 1, 2012. Edition 1.0.
- [87] National Institute of Standards and Technology (NIST), "NIST Identifies Five 'Foundational' Smart Grid Standards". [Online]. Available: http://www.nist.gov/public_affairs/releases/smartgrid_100710.cfm
- [88] International Electrotechnical Commission, "Project IEC 61970-301, Energy management system application program interface (EMS-API) – Part 301: Common information model (CIM) base", IEC, 2013, Edition 4.0.
- [89] International Electrotechnical Commission, "IEC 61968-11, Application integration at electric utilities – System interfaces for distribution management - Part 11: Common information model (CIM) extensions for distribution", IEC, 2012, Edition 1.0, Draft.
- [90] International Electrotechnical Commission, "IEC 62325-301, Framework for energy market communications – Part 301: Common information model (CIM) Extensions for Markets", IEC, 2012, Edition 1.0, Draft
- [91] International Electrotechnical Commission, "IEC 62325-351, Framework for energy market communications – Part 351: CIM European market model exchange profile", IEC, 2013, Edition 1.0, Draft
- [92] European Union Commission Task Force for Smart Grids, "Functionalities of smart grids and smart meters", Expert Group 1, 2010. Final Deliverable.
- [93] Institute of Electrical and Electronic Engineers, "2030-2011 - IEEE Guide for Smart Grid Interoperability of Energy Technology and Information Technology Operation with the Electric Power System (EPS), End-Use Applications and Loads", IEEE-SA Standards Board, 2011.
- [94] Electric Power Research Institute, "Common Information Model Primer", EPRI, 2011. Edition 1.0
- [95] M. Uslar, M. Specht, S. Rohjans, J. Trefke, J. M. Vasquez González, "The Common Information Model CIM, IEC 61968/61970 and 62325 – A practical introduction to the CIM", Springer-Verlag Berlin Heidelberg, 2012.
- [96] A. W. McMorran, R. W. Lincoln, G. A. Taylor and E. M. Stewart, "Addressing misconceptions about the common information model

- (CIM)," in *Power and Energy Society General Meeting, 2011 IEEE*, 2011, pp. 1-4.
- [97] M. E. Goodrich, "Role of interoperability tests in standardizing CIM," in *Power & Energy Society General Meeting, 2009. PES '09. IEEE*, 2009, pp. 1-4.
- [98] E. Lambert and A. Quéric, "Use of CIM for EDF distribution automation," in *Power and Energy Society General Meeting, 2010 IEEE*, 2010, pp. 1-4.
- [99] D. S. Popovic, E. Varga and Z. Perlic, "Extension of the Common Information Model With a Catalog of Topologies," *Power Systems, IEEE Transactions on*, vol. 22, pp. 770-777, 2007.
- [100] Hongbin Sun, Boming Zhang and Wenchuan Wu, "Applications and extension of CIM standard in chinese electrical power control centers," in *Power & Energy Society General Meeting, 2009. PES '09. IEEE*, 2009, pp. 1-4.
- [101] D. Becker, T. L. Saxton and M. Goodrich, "CIM standard for dynamic model exchange," in *Power and Energy Society General Meeting, 2010 IEEE*, 2010, pp. 1-3.
- [102] Y. Pradeep, P. Seshuraju, S. A. Khaparde and R. K. Joshi, "CIM-Based Connectivity Model for Bus-Branch Topology Extraction and Exchange," *Smart Grid, IEEE Transactions on*, vol. 2, pp. 244-253, 2011.
- [103] Kai-Ning Xu, Cheng Xin-Gong, Xu Xi-Ji and Chong Yan-Shi, "Model design of electric system state estimation based on CIM," in *Power and Energy Engineering Conference, 2009. APPEEC 2009. Asia-Pacific*, 2009, pp. 1-4.
- [104] Qin LiJun, Guo Qing, Hao CuiJuan and Jin HuaWei, "A new wide area measurement system model based on common information model," in *Electric Utility Deregulation and Restructuring and Power Technologies (DRPT), 2011 4th International Conference on*, 2011, pp. 1061-1066.
- [105] Xu Kang and Zhou Huiying, "Design of secondary equipment management system based on CIM," in *Power and Energy Engineering Conference (APPEEC), 2012 Asia-Pacific*, 2012, pp. 1-4.
- [106] T. D. Nielsen, S. A. Neumann and T. L. King, "A methodology for managing model extensions when using the common information model for systems integration," in *Power & Energy Society General Meeting, 2009. PES '09. IEEE*, 2009, pp. 1-5.

- [107] Xiaofeng Wang and S. Van Ausdall, "Representing business data semantics in CIM using UML," in *Power Systems Conference and Exposition, 2006. PSCE '06. 2006 IEEE PES*, 2006, pp. 480-486.
- [108] W3C, "Namespaces in XML 1.0" [Online] Available: <http://www.w3.org/TR/REC-xml-names/#sec-intro>
- [109] W3C, "Architecture of the World Wide Web", 2004, Volume 1. [Online] Available: <http://www.w3.org/TR/webarch/#URI-collision>
- [110] C. Gonzalez-Perez and B. H. Sellers, "Modelling software development methodologies: A conceptual foundation," *J. Syst. Software*, vol. 80, pp. 1778-1796, NOV 2007, 2007.
- [111] B. Chandrasekaran, J. R. Josephson and V. R. Benjamins, "What are ontologies, and why do we need them?" *Intelligent Systems and their Applications, IEEE*, vol. 14, pp. 20-26, 1999.
- [112] M. Uslar, S. Rohjans, M. Specht and J. M. G. Vázquez, "What is the CIM lacking?" in *Innovative Smart Grid Technologies Conference Europe (ISGT Europe), 2010 IEEE PES*, 2010, pp. 1-8.
- [113] R. Santodomingo, J. A. Rodríguez-Mondéjar and M. A. Sanz-Bobi, "Ontology matching approach to the harmonization of CIM and IEC 61850 standards," in *Smart Grid Communications (SmartGridComm), 2010 First IEEE International Conference on*, 2010, pp. 55-60.
- [114] R. Santodomingo, J. A. Rodriguez-Mondejar, M. A. Sanz-Bobi, S. Rohjans and M. Uslar, "Towards the automatic alignment of CIM and SCL ontologies," in *Smart Grid Communications (SmartGridComm), 2011 IEEE International Conference on*, 2011, pp. 422-427.
- [115] International Electrotechnical Commission, "IEC/TR 61850-1, Communication networks and systems in substations – Part 1: Introduction and overview", IEC, 2004, Edition 1.0
- [116] W3C, "OWL Web Ontology Language Overview", W3C Recommendation, 2004. Available [Online] <http://cies.hhu.edu.cn/pweb/~zhuoming/teachings/MOD/N4/Readings/5.3-B1.pdf>
- [117] Y. K. Peña, A. Pena and O. K. Esteban, "Semantic integration of IEC 60870 into CIM," in *Smart Grid Communications (SmartGridComm), 2011 IEEE International Conference on*, 2011, pp. 428-433.
- [118] W3C, "SPARQL 1.1 Overview", W3C Recommendation, 2013. Available [Online] <http://www.w3.org/TR/sparql11-overview/>

- [119] State Grid Corporation of China, "SGCC Framework and Roadmap for Strong and Smart Grid standards", Whitepaper, 2010.
- [120] P. Barnaghi, W. Wang, C. Henson and K. Taylor, "Semantics for the Internet of Things: Early Progress and Back to the Future," *International Journal on Semantic Web and Information Systems*, vol. 8, pp. 1-21, 2012, 2012.
- [121] S. Neumann, J. Britton, A. DeVos, S. Widergren, "Use of the CIM Ontology", DistribuTech, 2006. [Online] Available: http://uisol.com/uisol/papers/Use_of_the_CIM_Ontology_DistribuTech_2006_Paper.pdf
- [122] S. Quiroigico, P. Assis, A. Westerinen, M. Baskey and E. Stokes, "Toward a formal common information model ontology," *Web Information Systems - Wise 2004 Workshops, Proceedings*, vol. 3307, pp. 11-21, 2004, 2004.
- [123] HuiXian Tang and Liangrong Song, "Ontologies in financial services: Design and applications," in *Business Management and Electronic Information (BMEI), 2011 International Conference on*, 2011, pp. 364-367.
- [124] A. M. Sourouni, S. Mouzakitis, G. Kourlimpinis, D. Askounis and G. Velegrakis, "E-business transactions modelling; an ontology-based repository," in *Interoperability for Enterprise Software and Applications China, 2009. IESA '09. International Conference on*, 2009, pp. 63-69.
- [125] E. Bertino, "Integration of heterogeneous data repositories by using object-oriented views," in *Interoperability in Multidatabase Systems, 1991. IMS '91. Proceedings., First International Workshop on*, 1991, pp. 22-29.
- [126] K. F. Abdalla, "A model for semantic interoperability using XML," in *Systems and Information Engineering Design Symposium, 2003 IEEE*, 2003, pp. 107-111.
- [127] D. Bogen, G. Latisko and K. Dziegielewski, "The journey to the centralized CIM based network data model management at ONCOR," in *Power and Energy Society General Meeting, 2012 IEEE*, 2012, pp. 1-5.
- [128] M. Chen and E. H. Sibley, "Using a CASE based repository for systems integration," in *System Sciences, 1991. Proceedings of the Twenty-Fourth Annual Hawaii International Conference on*, 1991, pp. 578-587 vol.2.
- [129] J. D. Moseley, W. M. Grady and S. Santoso, "New approaches for smart device integration and maintenance of power system models

utilizing a unified data schema," in *Innovative Smart Grid Technologies (ISGT), 2013 IEEE PES*, 2013, pp. 1-6.

- [130] M. Bennett, "Semantics standardization for financial industry integration," in *Collaboration Technologies and Systems (CTS), 2011 International Conference on*, 2011, pp. 439-445.
- [131] C. Rueda, L. Bermudez and J. Fredericks, "The MMI ontology registry and repository: A portal for marine metadata interoperability," in *OCEANS 2009, MTS/IEEE Biloxi - Marine Technology for our Future: Global and Local Challenges*, 2009, pp. 1-6.
- [132] R. Ferreira, J. Moura-Pires, R. Martins and M. Pantoquilha, "XML based metadata repository for information systems," in *Artificial Intelligence, 2005. Epia 2005. Portuguese Conference on*, 2005, pp. 205-213.
- [133] Gartner, "Enterprise Information Management – Getting value from Information Assets", Gartner Business Intelligence Summit, 2006.
- [134] M. Prabhakaran, C. Chou "Semantic integration in Enterprise Information Management", in SETLabs Briefings, Vol 4. No. 2. Infosys Technologies Limited. 2006
- [135] L. E. Arnold and J. Hajagos, "LIPA implementation of real-time stability monitoring in a CIM compliant environment," in *Power Systems Conference and Exposition, 2009. PSCE '09. IEEE/PES*, 2009, pp. 1-6.
- [136] E. Margalejo, P. A. Lof, X. Liu and P. Picard, "First EMS experience building, validating and maintaining a network model using CIM," in *Power & Energy Society General Meeting, 2009. PES '09. IEEE*, 2009, pp. 1-6.
- [137] E. Wuergler and C. Vanhemelryck, "Use of CIM for workflows across network operation, asset management and network planning systems at a distribution utility," in *Power and Energy Society General Meeting, 2012 IEEE*, 2012, pp. 1-4.
- [138] P. Vujovic and G. Robinson, "Use of the CIM standard for managing assets at the long island power authority," in *Power & Energy Society General Meeting, 2009. PES '09. IEEE*, 2009, pp. 1-6.
- [139] J. Z. Cao, H. J. Zhou, Y. Z. Tang and C. X. Guo, "Realization of electric power enterprise application integration based on service oriented architecture," in *Power and Energy Society General Meeting, 2010 IEEE*, 2010, pp. 1-5.
- [140] E. Haq, D. Haller and E. Rodriguez, "Use of CIM standard in power system modeling & enterprise wide messaging at California ISO," in *Power and Energy Society General Meeting, 2010 IEEE*, 2010, pp. 1-6.

- [141] E. Haq, Xiaofeng Wang, S. X. Hu, K. Colmer, K. Hunter, B. Iverson and H. Garton, "Application of CIM extension principles and guidelines in modeling CAISO market system," in *Power and Energy Society General Meeting - Conversion and Delivery of Electrical Energy in the 21st Century, 2008 IEEE*, 2008, pp. 1-6.
- [142] Xing Wang and But-Chung Chiu, "CIM modeling for market management systems," in *Power and Energy Society General Meeting, 2010 IEEE*, 2010, pp. 1-5.
- [143] B. A. Scovill, "Implementation of CIM for network model and assets at a utility," in *Power and Energy Society General Meeting, 2012 IEEE*, 2012, pp. 1-5.
- [144] P. R. Ilich, R. Riddles, W. Haak and R. Frowd, "Application of CIM model for enterprise wide power system model for planning, protection and operations," in *Power and Energy Society General Meeting - Conversion and Delivery of Electrical Energy in the 21st Century, 2008 IEEE*, 2008, pp. 1-6.
- [145] E. Lambert, "Common information based on CIM approach : Is it a dream or a reality? remaining challenges based on concrete experience," in *Power and Energy Society General Meeting - Conversion and Delivery of Electrical Energy in the 21st Century, 2008 IEEE*, 2008, pp. 1-6.
- [146] N. Dahal, V. M. Mohan, S. S. Durbha, A. K. Srivastava, R. L. King, N. H. Younan and N. N. Schulz, "Wide area monitoring using common information model and sensor web," in *Power Systems Conference and Exposition, 2009. PSCE '09. IEEE/PES*, 2009, pp. 1-7.
- [147] C. R. Philbrick, "Wind integration and the evolution of power system control," in *Power and Energy Society General Meeting, 2010 IEEE*, 2010, pp. 1-6.
- [148] Jun Zhu, E. Zhuang, C. Ivanov and Ziwen Yao, "A Data-Driven Approach to Interactive Visualization of Power Systems," *Power Systems, IEEE Transactions on*, vol. 26, pp. 2539-2546, 2011.
- [149] A. W. McMorran, R. W. Lincoln and E. Wuergler, "CIM graphics exchange," in *Power Systems Conference and Exposition (PSCE), 2011 IEEE/PES*, 2011, pp. 1-3.
- [150] National Grid, "Transmission", 2013. [Online] Available: <http://www.nationalgrid.com/corporate/Our+Businesses/Transmission/>
- [151] D. Logan, "Hype Cycle for Enterprise Information Management", Gartner, 2012. [Online] Available: <http://www.gartner.com/id=2094617>

- [152] European Network of Transmission System Operators for Electricity, "Naming convention for ENTSO-E CIM based exchange (using CIM 16)", ENTSO-E, 2013. Draft version 2.
- [153] B. Dolan, "The use of CIM within UK Transmission", 2010. National Grid, UK.
- [154] N. Hargreaves, G. Taylor and A. Carter, "Information standards to support application and enterprise interoperability for the smart grid," in *Power and Energy Society General Meeting, 2012 IEEE*, 2012, pp. 1-6.
- [155] D. Becker, T. Saxton, "The missing piece in achieving interoperability – a common information model (CIM)-based semantic model", *Grid-Interop Forum*, 2007.
- [156] N. Hargreaves, G. Taylor, A. Carter and A. McMorran, "Developing emerging standards for power system data exchange to enable interoperable and scalable operational modelling and analysis," *Universities' Power Engineering Conference (UPEC), Proceedings of 2011 46th International*, pp. 1-5, 2011.
- [157] G. Strbac, R. Moreno, D. Pudjianto and M. Castro, "Towards a risk-based network operation and design standards," in *Power and Energy Society General Meeting, 2011 IEEE*, 2011, pp. 1-4.
- [158] M. G. Lauby, "System reliability and risk management: Effects on system planning, operation, asset management, and security," in *Power and Energy Society General Meeting, 2012 IEEE*, 2012, pp. 1-4.
- [159] R. Entriken, P. Varaiya, F. Wu, J. Bialek, C. Dent, A. Tuohy and R. Rajagopal, "Risk limiting dispatch," in *Power and Energy Society General Meeting, 2012 IEEE*, 2012, pp. 1-5.
- [160] Tongxin Zheng and E. Litvinov, "Operational risk management in the future grid operation," in *Power and Energy Society General Meeting, 2011 IEEE*, 2011, pp. 1-3.
- [161] P. Mell, T. Grance, "The NIST definition of cloud computing", Recommendations of the National Institute of Standards and Technology, Special Publication 800-145, 2012.
- [162] I. M. Abbadi, "Operational trust in clouds' environment," in *Computers and Communications (ISCC), 2011 IEEE Symposium on*, 2011, pp. 141-145.
- [163] S. Aman, Y. Simmhan and V. K. Prasanna, "Energy management systems: state of the art and emerging trends," *Communications Magazine, IEEE*, vol. 51, pp. 114-119, 2013.

- [164] Xi Fang, Dejun Yang and Guoliang Xue, "Evolving Smart Grid Information Management Cloudward: A Cloud Optimization Perspective," *Smart Grid, IEEE Transactions on*, vol. 4, pp. 111-119, 2013.
- [165] Fengji Luo, Zhao Yang Dong, Yingying Chen, Yan Xu, Ke Meng and Kit Po Wong, "Hybrid cloud computing platform: The next generation IT backbone for smart grid," in *Power and Energy Society General Meeting, 2012 IEEE*, 2012, pp. 1-7.
- [166] Ling Zheng, Shuangbao Chen, Yanxiang Hu and Jianping He, "Applications of cloud computing in the smart grid," in *Artificial Intelligence, Management Science and Electronic Commerce (AIMSEC), 2011 2nd International Conference on*, 2011, pp. 203-206.
- [167] Zhang Liang and Li Xiuqing, "The core of constructing the future power systems computation platform is cloud computing," in *Mechatronic Science, Electric Engineering and Computer (MEC), 2011 International Conference on*, 2011, pp. 933-937.
- [168] G. Taylor, "Into the cloud – smart grid communications", Energy World, E.I. Publications, 2012, pp. 20-21.
- [169] Y. Simmhan, V. Prasanna, S. Aman, A. Kumbhare, R. Liu, S. Stevens and Q. Zhao, "Cloud-Based Software Platform For Big Data Analytics In Smart Grids," *Computing in Science & Engineering*, vol. PP, pp. 1-1, 2013.
- [170] Y. Simmhan, A. G. Kumbhare, Baohua Cao and V. Prasanna, "An analysis of security and privacy issues in smart grid software architectures on clouds," in *Cloud Computing (CLOUD), 2011 IEEE International Conference on*, 2011, pp. 582-589.
- [171] K. Maheshwari, M. Lim, L. Wang, K. Birman and R. van Renesse, "Toward a reliable, secure and fault tolerant smart grid state estimation in the cloud," in *Innovative Smart Grid Technologies (ISGT), 2013 IEEE PES*, 2013, pp. 1-6.
- [172] Microsoft Corporation, "Windows Azure", 2013. [Online] Available: <http://www.windowsazure.com/en-us/>
- [173] Amazon Web Services, "Amazon Elastic Compute Cloud, Amazon EC2", 2013. [Online] Available: <http://aws.amazon.com/ec2/>
- [174] Google Cloud Platform, "Google App Engine", 2013. [Online] Available https://cloud.google.com/products/?utm_source=google&utm_medium=pc&utm_campaign=appengine-search-global

- [175] D. Wallom, M. Turilli, G. Taylor, N. Hargreaves, A. Martin, A. Raun and A. McMoran, "myTrustedCloud: Trusted cloud infrastructure for security-critical computation and data management," in *Cloud Computing Technology and Science (CloudCom), 2011 IEEE Third International Conference on*, 2011, pp. 247-254.
- [176] S. Rusitschka, K. Eger and C. Gerdes, "Smart grid data cloud: A model for utilizing cloud computing in the smart grid domain," in *Smart Grid Communications (SmartGridComm), 2010 First IEEE International Conference on*, 2010, pp. 483-488.
- [177] I. M. Abbadi and C. Namiluko, "Dynamics of trust in clouds — challenges and research agenda," in *Internet Technology and Secured Transactions (ICITST), 2011 International Conference for*, 2011, pp. 110-115.
- [178] D. Nurmi et al., "The Eucalyptus Open-Source Cloud- Computing System," *Cloud Computing and Applications 2008 (CCA 08)*, 2008.
- [179] Oxford e-Research Centre, [Online] Available: <http://www.oerc.ox.ac.uk/>
- [180] Open Grid Systems Ltd. [Online] Available: <https://cimphony.com/content/>
- [181] DigSILENT GmbH, PowerFactory. [Online] Available: <http://www.digsilent.de/index.php/products-powerfactory.html>
- [182] Siemens, PSS®E Product Suite. [Online] Available: <http://www.energy.siemens.com/hq/en/services/power-transmission-distribution/power-technologies-international/software-solutions/pss-e.htm>
- [183] C. Mitchell, "Trusted Computing", 2005. The Institution of Engineering and Technology, UK.
- [184] R. Toegl et al., "Towards Platform-Independent Trusted Computing," *Proc. 2009 ACM Workshop Scalable Trusted Computing (STC 09)*, ACM Press, 2009, pp. 61–66.
- [185] Trusted Computing Group, "Open Platform Trust Service". [Online] Available: <http://sourceforge.jp/projects/openpts/>
- [186] A. Nagarajan, V. Varadharajan, M. Hitchens and E. Gallery, "Property based attestation and trusted computing: Analysis and challenges," in *Network and System Security, 2009. NSS '09. Third International Conference on*, 2009, pp. 278-285.
- [187] N. Hargreaves, S. Pantea, G. Taylor and M. Irving, "A critical comparison of approaches to resource name management within the

IEC common information model," in *Innovative Smart Grid Technologies (ISGT Europe), 2012 3rd IEEE PES International Conference and Exhibition on*, 2012, pp. 1-6.

- [188] J. D. Appen, R. McDaniel, "The Rhetorical Nature of XML – Constructing Knowledge in Networked Environments", 2009, Routledge.
- [189] J. McDonald, "Extracting value from data", in *Electricity Today*, May 2013. Vol. 26, No. 4. [Online] Available: http://online.electricity-today.com/doc/electricity-today/et_may_2013_digital/2013051701/%238#0
- [190] R. E. Bryant, C. Hensel, R. H. Katz and E. P. Gianchandani, "From data to knowledge to action: Enabling the smart grid," in *Computing Community Consortium, Version 5*, 2005.
- [191] M.E. Porter, "Competitive Advantage: Creating and Sustaining Superior Performance", 1985. Free Press, New York City.
- [192] T. Powell, "The Knowledge Value Chain (KVC): How to Fix It When It Breaks", in *KnowledgeNets 2001, Proceedings of the 22nd Online Meeting*, New York City.
- [193] IBM, "Analytics: The real-world use of big data", IBM Institute for Business Value in collaboration with Saïd Business School, University of Oxford, Executive Report, 2012. [Online] Available: www.ibm.com/systems/hu/resources/the_real_word_use_of_big_data.pdf
- [194] C. K. Ogden, I. A. Richards, "The meaning of meaning", 1923. Brace and World. New York: Harcourt.
- [195] B. Henderson-Sellers, "On the Mathematics of Modelling, Metamodeling, Ontologies and Modelling Languages", 2012. Springer
- [196] N. B. Hargreaves, S. M. Pantea, A. Carter, G. A. Taylor, "Foundations of a metamodel repository for use with the IEC Common Information Model", *Power Systems, IEEE Transactions on*, 2013 [Accepted June 2013].
- [197] B. Hendereson-Sellers, B. Unhelkar, "OPEN modeling with UML", 2000. 245pp. Harlow, UK: Addison-Wesley.
- [198] Power Info, "CIMdesk", 2013. [Online] Available: <http://www.powerinfo.us/CIMdesk.html>
- [199] N. Hargreaves, G. Taylor and A. Carter, "Smart grid interoperability use cases for extending electricity storage modeling within the IEC common

information model," in *Universities Power Engineering Conference (UPEC), 2012 47th International*, 2012, pp. 1-6.

- [200] ScienceDaily, "Computerized Agents for Smart Electricity," 2010. [Online] Available: <http://www.sciencedaily.com/releases/2010/05/100505092527.htm>
- [201] D. Graham-Rowe, "Smart-grid 'stockbrokers' to manage your power," 2011. *New Scientist*, Issue 2802. <http://www.newscientist.com/article/mg20928025.700-smartgrid-stockbrokers-to-manage-your-power.html?>
- [202] International Electrotechnical Commission, "Electrical Energy Storage" White Paper, 2011.
- [203] International Electrotechnical Commission, TC 120 for smart grid integration", 2012. [Online] Available: http://www.iec.ch/etech/2012/etech_1112/tc-3.htm
- [204] B. P. Roberts and C. Sandberg, "The Role of Energy Storage in Development of Smart Grids," *Proceedings of the IEEE*, vol. 99, pp. 1139-1144, 2011.
- [205] G. D. Rodriguez, "A utility perspective of the role of energy storage in the smart grid," in *Power and Energy Society General Meeting, 2010 IEEE*, 2010, pp. 1-2.
- [206] S. O. Geurin, A. K. Barnes and J. C. Balda, "Smart grid applications of selected energy storage technologies," in *Innovative Smart Grid Technologies (ISGT), 2012 IEEE PES*, 2012, pp. 1-8.
- [207] US Department of Energy, "National Assessment of Energy Storage for Grid Balancing and Arbitrage", 2012, Phase 1 WECC. Pacific Northwest Laboratory, USA.
- [208] Energy Futures Lab, Imperial College London, "Strategic assessment of the role and value of energy storage systems in the UK low carbon energy future", Report for the Carbon Trust, 2012. Hubnet.
- [209] A. M. Gopstein, "Energy Storage & the Grid - From Characteristics to Impact [Point of View]," *Proceedings of the IEEE*, vol. 100, pp. 311-316, 2012.
- [210] C. E. T. Foote, A. J. Roscoe, R. A. F. Currie, G. W. Ault and J. R. McDonald, "Ubiquitous energy storage," in *Future Power Systems, 2005 International Conference on*, 2005, pp. 6 pp.-6.
- [211] Highview Power Storage, "Cryogenic Energy Storage", 2013. [Online] Available: http://www.highview-power.com/wordpress/?page_id=1320f

- [212] ABB, "Energy storage – smoothing the transition to smarter grids". 2011. [Online] Available: <http://www.abb.com/cawp/seitp202/4ec961176b95a792c125793100300be8.aspx>
- [213] ABB Case note, "World's Largest Battery Energy Storage System. Fairbanks, Alaska." [Online] Available: [http://www05.abb.com/global/scot/scot232.nsf/veritydisplay/3c4e15816e4a7bf1c12578d100500565/\\$file/case_note_bess_gvea_fairbanks-web.pdf](http://www05.abb.com/global/scot/scot232.nsf/veritydisplay/3c4e15816e4a7bf1c12578d100500565/$file/case_note_bess_gvea_fairbanks-web.pdf)
- [214] J. Kumagai, "A Battery as Big as the Grid". IEEE Spectrum Inside Inside Technology, 2012. [Online] Available: <http://spectrum.ieee.org/energy/the-smarter-grid/a-battery-as-big-as-the-grid>
- [215] Y. V. Makarov, Pengwei Du, M. C. W. Kintner-Meyer, Chunlian Jin and H. F. Illian, "Sizing Energy Storage to Accommodate High Penetration of Variable Energy Resources," *Sustainable Energy, IEEE Transactions on*, vol. 3, pp. 34-40, 2012.
- [216] N. Kawakami, Y. Iijima, Y. Sakanaka, M. Fukuhara, K. Ogawa, M. Bando and T. Matsuda, "Development and field experiences of stabilization system using 34MW NAS batteries for a 51MW wind farm," in *Industrial Electronics (ISIE), 2010 IEEE International Symposium on*, 2010, pp. 2371-2376.
- [217] A. D. Shakib and G. Balzer, "Energy storage design and optimization for power system with wind feeding," in *Probabilistic Methods Applied to Power Systems (PMAPS), 2010 IEEE 11th International Conference on*, 2010, pp. 54-59.
- [218] M. L. Lazarewicz and T. M. Ryan, "Integration of flywheel-based energy storage for frequency regulation in deregulated markets," in *Power and Energy Society General Meeting, 2010 IEEE*, 2010, pp. 1-6.
- [219] Pacific Northwest, "Power grid getting smarter with big battery in Salem", 2013. Smart Grid Demonstration Project. [Online] Available: <http://www.pnwsmartgrid.org/news.asp>
- [220] Electric Transmission Texas, "Electric Transmission Texas brings largest utility-scale battery in the United States to oldest cities in Texas", 2010. [Online] Available: <http://www.ettexas.com/projects/presnas.asp>
- [221] Sparx Systems, Enterprise Architect, v9.3 Corporate Edition", 2012. [Online] Available: www.sparxsystems.com

[222] J. Simmins, "Common Information Model (CIM) 2012 Update: EPRI Development, Testing Activity and Plans", 2013, EPRI Technical Update. Document number 3002000406.

APPENDIX

CONFERENCES AND CURRICULAR MODULES ATTENDED

The following list gives details of conferences attended and curricular modules completed as part of the Brunel Industrial Doctorate Scheme conditions:

Date	Event
15/Sep/10	Europe: Looking Ahead on Climate Change Green Alliance, EC, ECF, Transform UK – ImechE, London
11-14/Oct/10	UCAIug/CIM Users Group , San Francisco The Role of CIM in the Smart Grid
19-21/Oct/10	European Future Energy Forum , London
29/Oct/10	Tokyo Electric Power Company (TEPCO) , London
2-3/Nov/10	Research Skills Induction Course , Brunel University
22-26/Nov/10	EE5520: Power System Analysis and Security Course , Brunel University
1/Dec/10	Visit to West Weybridge Substation , Brunel University/National Grid
9/Dec/10	Novel ICT Solutions for Smart Grids KTN , Brunel University Energy Generation & Supply/Digital Communications KTN
13-15/Dec/10	The Common Information Model for Power Systems Alan McMorran training workshop, National Grid, Wokingham
19-21/Jan/11	Synergistic Supergrids for Transmitting Energy Overseas 2011 , Innocube, London
25/Jan/11	Visit to Ratcliffe Power Station , E.ON UK/Brunel University

- 31/Jan
- 4/Feb/11 **EE5522: Power System Operation and Management,**
Brunel University
- 14-15/Mar/11 **Brunel Research Students Poster Competition[†],** Brunel
University (Presented poster)
- 25/Mar/11 **Visit to Coreso,** National Grid, Belgium
- 6-4/Apr/11 **CIM workshop,** CIM training with Alan McMorran,
National Grid, Wokingham
- 10-13/May/11 **CIM Users Group,** Prague
The Role of the CIM in the European Commission mandate
for Smart Grid
- 6-8/Jun/11 **North Sea Offshore Networks; Enabling Offshore Wind
and Balancing Power,** UK-Norway Forum and
Roadmapping Workshop, UKERC, SINTEFF, Brunel
University, London
- 3-15/Jun/11 **Erasmus I.P. European Summer School,** TEI, Crete.
(Top mark awarded in end of course examination)
- 5-9/Sep/11 **Universities Power Engineering Conference,** Soest
(Presented paper)
- 9/Sep/11 **Network Operations Conference,** National Grid, Oxford
- 15-18/Nov/11 **UCAIug/CIM Users Group,** Austin, Texas
Advancing Interoperability for the Utility Enterprise and
Systems
- 15-18/May/12 **CIM Users Group,** London
CIM Implementation and Application to Support the
European Smart Grid
- 6-7/Jun/12 **SMi third annual conference,** London
Realisation of the Future Smart Grid
- 17-22/Jun/12 **UKERC Summer School,** Warwick University
(Led team in energy decarbonisation exercise)
- 25-26/Jun/12 **SMi conference,** London
Grid-Scale Energy Storage
- 23-27/Jul/12 **IEEE PES General Meeting,** San Diego

- (Presented paper)
- 4-7/Sep/12 **Universities Power Engineering Conference**, Brunel University (Presented paper)
- 11-12/Oct/12 **HubNet Smart Grids Symposium**, Bristol (Presented poster)
- 25/Sep/12 **Network Operations Conference**, National Grid, Oxford
- 3/Oct/11 **IET Future Energy Forum**, London (Presented poster)
- 15-18/Oct/12 **IEEE PES 3rd ISGT Europe**, Berlin (Presented paper)
- 22-26/Oct/12 **UCAIug/CIM Users Group**, New Orleans
Advancing Interoperability for the Utility Enterprise and Systems (Made presentations)
- 15/Nov/12 **First DNO Information Management Working Group Conference**, National Grid, Warwick (Made presentation)
- 16/Nov/12 **WAMPAC Workshop**, Brunel University (Made presentation)
- 25-26/Apr/13 **UKERC Sparks Symposium**, University of Oxford
Interdisciplinary Research, Communication and Dissemination (Best collaborative research proposal)