

BRUNEL UNIVERSITY, LONDON



Implementation of Spectrum Sensing Techniques for Cognitive Radio Systems

A thesis submitted in partial fulfillment of the requirements for the degree of Doctor of
Philosophy (Ph.D.) to:
Electronic and Computer Engineering,
School of Engineering and Design,
Brunel University,
United Kingdom.

by:
Nazar Radhi

July 2011

Supervised By:
Professor Hamed Al-Raweshidy

Abstract

This work presents a method for real-time detection of secondary users at the cognitive wireless technologies base stations. Cognitive radios may hide themselves in between the primary users to avoid being charged for spectrum usage. To deal with such scenarios, a cyclostationary Fast Fourier Transform accumulation method (FAM) has been used to develop a new strategy for recognising channel users under perfect and different noise environment conditions. Channel users are tracked according to the changes in their signal parameters, such as modulation techniques. MATLAB[®] Simulation tool was used to run various modulation signals on channels, and the obtained spectral correlation density function shows successful recognition between secondary and primary signals. We are unaware of previous efforts to use the FAM characteristics or other detection methods to make a distinction between channel users as presented in this thesis.

A novel combination of both cognitive radio technology and ultra wideband technology is interdicted in this thesis, looking for an efficient and reliable spectrum sensing method to detect the presence of primary transmitters, and a number of spectrum-sensing techniques implemented in ultra wideband and cognitive radio component (UWB-CR) under different AWGN and fading settings environments. The sensing performance of different detectors is compared in conditions of probability of detection and miss detection curves. Simulation results show that the selection of detectors rely on the different fading scenarios, detector requirements and on a priori knowledge. Furthermore, result showed that the matched filter detection method is suitable for detecting signals through UWB-CR system under various fading channels. A general observation is that the matched filter detector outperforms the other detectors in all scenarios by an average of SNR=-20 dB in the level of probability of detection ($P_d \geq 0.8$), and the energy detector slightly outperforms the cyclostationary detector, in the level $P_d \geq 0.1$ at SNR=-20 dB.

Furthermore, the thesis adapts novel detection models of cooperative and cluster cooperative wideband spectrum sensing in cognitive radio networks. In the proposed schemes, wavelet-based multi-resolution spectrum sensing and a proposed approach scheme are utilized for improving sensing performance of both models. On the other hand, cluster based cooperative spectrum sensing with soft combination Equal Gain Combination (EGC) scheme is proposed. The proposed detection models could achieve improvement of transmitter signal detection in terms of higher probability of detection and lower probability of false alarm. In the cooperative wideband spectrum sensing model, using traditional fusion rule, existing worst performance of false alarms by measurement is 78% of the sensing bands at an average SNR=5 dB; this compares with the proposed model, which is by measurement 19% false alarms of scanning spectrum at the same SNR for cluster cooperative wideband spectrum sensing. The proposed combining methods shows improvements of results with a high probability of detection (P_d) and low probability of false alarm (P_f) at an average SNR=-16 dB compared with other traditional fusion methods; this is illustrated through numerical results.

Acknowledgments:

I am grateful to the creator who taught the names to Adam and gave human being authority to pass beyond the zones of heavens and earth, without his blessing and mercy, this thesis would not have been possible.

I like to thank my wife and my daughters for their constant support and encouragement.

I also owe my deepest gratitude to my mother, brothers and my sisters without whom I would not have made it through my PhD degrees. Their tremendous help and prayers showed me the way and always guided me to the end of the tunnel.

It is my pleasure to thank all those who made this thesis possible. I am heartily thankful to my supervisor, Professor Hamed Al-Raweshidy and my brother, Dr Haidar Radi whose encouragement, guidance and support from the initial to the final level enabled me to develop an understanding of this work. I appreciate all their help and support. I am indebted to my many of my colleagues at the WNCC and friends at Brunel University. I would like to show my gratitude to all staff at Brunel University, I would like to thank their encouraging and supportive attitude.

I would like to express gratitude to those who helped me to finalize my thesis; without them, I could not have written this thesis.

Lastly, I offer my regards to all of those who supported me in any respect during the completion of the project.

Table of Contents

Chapter-1: Introduction	1
<i>Introduction</i>	1
1.1 Motivations.....	1
1.2 Aims and Objectives	3
1.3 Contribution to Knowledge	5
1.4 Research Methodology	6
1.5 Thesis Structure	7
Chapter-2: Cognitive Radio System	9
<i>Cognitive Radio System</i>	9
2.1 Cognitive Radio System	9
2.1.1 Main Function	9
2.1.2 Cognitive Cycle	10
2.2 Spectrum Sensing	11
2.2.1 Challenges & Spectrum Sensing	12
2.2.2 Multi-dimensional Space for Spectrum Sensing	13
2.3 Spectrum Sensing Technique	16
2.3.1 Uncooperative Spectrum Detection (Transmitter Detection)	16
2.3.1.1 Energy Detection	16
2.3.1.2 Matched Filter Detection	17
2.3.1.3 Cyclostationary Detection	18
2.3.2 Cooperative Spectrum Detection	19

2.3.2.1	Centralized Sensing Method	23
2.3.2.2	Distributed Sensing Method	23
2.3.3	Primary Receiver Detection	24
2.4	Limitations and Challenges in Spectrum Sensing	25
Chapter-3: Cyclostationary Detection of Hidden Cognitive Radio Users		28
<i>Cyclostationary Detection of Hidden Cognitive Radio Users.....</i>		<i>28</i>
3.1	Introduction and Motivation	28
3.2	Scenarios to Detect Hidden Cognitive Radio	29
3.2.1	Sensing Spectrum Channel with free SNR	29
3.2.2	Sensing Spectrum Channels with low SNR	30
3.3	proposed approach	31
3.4	Detection Method in the proposed approach	32
3.4.1	Cyclostationary Processing Theory	32
3.4.2	Fast Fourier Transform Accumulation Method (FAM).....	36
3.4.3	Procedure of Signal Detection Method.....	37
3.5	Comparative performance analysis of the proposed approach	38
3.6	Simulation Scenarios and Results	39
3.7	Summary	53
Chapter-4: Performance of Spectrum Sensing Methods for UWB-CR System		54
<i>Performances of Spectrum Sensing Methods for UWB-CR System</i>		<i>54</i>
4.1	Introduction	54
4.2	Ultra Wideband System	55
4.3	Cognitive Radio Requirements with Ultra Wideband System Feature	58

4.3.1	Decrease Interference to licensed users	59
4.3.2	Dynamic Spectrum	59
4.3.3	Adaptable Transmit Power	59
4.3.4	Adjustable Multiple Access	60
4.3.5	Limited Cost	60
4.4	Combining UWB with Cognitive Radio	60
4.5	Characteristics of the Transmitter Signal	60
4.6	Spectrum Sensing Algorithms	61
4.6.1	Matched Filter Detection (MFD)	61
4.6.2	Energy Detection (ED)	62
4.6.3	Cyclostationary Detection (CD)	64
4.6.4	Channelized Detection (CHD)	66
4.7	Performance of Detection Schemes	68
4.7.1	Simulation Scenarios and Results	68
4.8	Summary	81
 Chapter-5: Cooperative Spectrum Sensing in Cognitive Radio System		82
<i>Cooperative Spectrum Sensing in Cognitive Radio System.....</i>		<i>82</i>
5.1	Introduction	82
5.2	Collaborative Wideband Spectrum Sensing in Cognitive Radio Network	84
5.3	Multi-Resolution Spectrum sensing Method	86
5.3.1	Wavelet-based Multi Resolution Spectrum sensing	86
5.4	Fusion Schemes in Cooperative Spectrum Sensing	90

5.4.1	Soft Combining	90
5.4.2	Hard Combining	91
5.4.3	Two-bit Hard Combining Scheme	93
5.4.4	proposed approach Scheme	94
5.5	Simulation Results	96
5.6	Cluster-Based Cooperative Wideband Spectrum	109
5.6.1	Description of Scenario Model	110
5.6.1.1	Local Spectrum Sensing	111
5.6.1.2	Local Sensing Decision (Equal Gain Combination Scheme)	111
5.6.1.3	Global Sensing Decision (proposed approach scheme)	112
5.6.2	Summary of the Proposed Method	112
5.6.3	Cluster Model Simulation and Results	113
5.7	Summary	117
Chapter-6: Conclusion and Future Work		118
<i>Conclusions and Future Work</i>		<i>118</i>
6.1	Conclusion	118
6.2	Future Work	118
List of Publications.....		120
References		122

List of Figures

Figure 1-1: Geographical Spectrum Holes	2
Figure 1-2: Time Domain Spectrum Holes	2
Figure 2-1: Fundamental Cognitive Cycle	11
Figure 2-2: Hiding Primary User Problem in Cognitive Radio System	12
Figure 2-3: Spectrum Opportunity in the Frequency and Time Domain Dimensions	13
Figure 2-4: Spectrum Opportunity in the Geographic Dimension	14
Figure 2-5: Spectrum Opportunity Code Dimension	14
Figure 2-6: Spectrum Opportunity in Angle Dimension	15
Figure 2-7: Spectrum Opportunity in Wave Dimension	15
Figure 2-8: Implementation of an Energy Detector	17
Figure 2-9: Implementation of a Matched Filtering Detector	18
Figure 2-10: Implementation of Cyclostationary Feature Detector	19
Figure 2-11: Primary Transmitted Detection: (I) Receiver uncertainty and (II) Shadowing uncertainty	21
Figure 2-12: Cooperative Primary Transmitter Signal Detection high Fading and Shadowing problem	22
Figure 2-13: Primary Receiver Detection	25
Figure 3-1: Proposed approach	30
Figure 3-2: Time-Variant Spectral Period Gram	34
Figure 3-3: Series of Frequency Products for each small Time FFT	35
Figure 3-4: FAM block Diagram	36
Figure 3-5: Detection Procedure	37
Figure 3-6: Cyclic Spectrum of the DSB-AM	40

Figure 3-7: Contour Figure of the DSB-AM Signal	40
Figure 3-8: Cyclic Spectrum of the BPSK Signal	41
Figure 3-9: Contour Figure of the BPSK Signal	42
Figure 3-10: Cyclic Spectrum of the DVB-T Signal with Free noise	43
Figure 3-11: Cyclic Spectrum of the AM Signal With free Noise	44
Figure 3-12: Contour Figure of the DVB-T Signal	44
Figure 3-13: Contour Figure of the AM Signal	45
Figure 3-14: Cyclic Spectrum of the DVB-T Signal with SNR=5	45
Figure 3-15: Cyclic Spectrum of the AM Signal with SNR=5	46
Figure 3-16: Contour Figure of the DVB-T Signal with SNR=5	47
Figure 3-17: Contour Figure of the AM modulation signal with SNR=5	47
Figure 3-18: Cyclic Spectrum of the DVB-T Signal with SNR=0	48
Figure 3-19: Cyclic Spectrum of the AM Modulation Signal with SNR=0	48
Figure 3-20: Contour Figure of the DVB-T Modulation Signal with SNR=0	49
Figure 3-21: Contour Figure of the AM Modulation signal with SNR=0	49
Figure 3-22: Cyclic Spectrum of the DVB-T Signal with SNR= -10	50
Figure 3-23: Cyclic Spectrum of the AM Signal with SNR= -10	51
Figure 3-24: Contour Figure of the DVB-T Modulation Signal with SNR= -10	51
Figure 3-25: Contour Figure of the AM Modulation Signal with SNR= -10	52
Figure 4-1: Model of Implementation different Spectrum Sensing Methods with different fading Channels	56
Figure 4-2: Demonstrates the Presenting FFC limits of limits of different UWB application	58
Figure 4-3: UWB Channelize with M subband	67
Figure 4-4: Probability of Detection (Pd) versus SNR for AWGN Channel Scenario (I)	69
Figure 4-5: Probability of Detection (Pd) versus SNR for Shadowing Channels Scenario (II)	70

Figure 4-6: Probability of Detection (P_d) versus SNR for Rayleigh Channel scenario (III)	71
Figure 4-7: Probability of Detection (P_d) versus SNR for Rice Channel Scenario (IV)	72
Figure 4-8: Probability of Detection (P_d) versus SNR for Rayleigh and Shadowing Channel scenario (V)	72
Figure 4-9: Probability of Miss Detection (P_{md}) versus SNR for AWGN channel Scenario (I) ...	73
Figure 4-10: Probability of Miss Detection (P_{md}) versus SNR for Shadowing channel Scenario (II)	74
Figure 4-11: Probability of Miss Detection (P_{md}) versus SNR for Rayleigh channel Scenario (III)	74
Figure 4-12: Probability of Miss Detection (P_{md}) versus SNR for Rice channel Scenario (IV)	75
Figure 4-13: Probability of Miss Detection (P_{md}) versus SNR for Rayleigh and Shadowing channel Scenario (V)	75
Figure 4-14: Probability of Detection (P_d) versus SNR for AWGN channel with various P_{fa} in different Sensing Method	76
Figure 4-15: Probability of Detection (P_d) versus SNR for Rayleigh and Shadowing channel with various P_{fa} in different Sensing Methods	76
Figure 4-16: Probability of Miss Detection (P_{md}) versus SNR for (CD, CHD $M=5$ and CHD $M=20$) Methods with various Fading Channels.....	77
Figure 4-17: Probability of Miss Detection (P_{md}) versus SNR for (ED, CD, CHD $M=20$) with various Fading Channels	77
Figure 4-18: Probability of Miss Detection (P_{md}) versus SNR for (MFD, ED and CD) Methods with various Fading Channels	78
Figure 4-19: Probability of Miss Detection (P_{md}) versus SNR for (CHD $M=5$, ED and MFD) Methods with various Fading Channels	78
Figure 4-20: Probability of Miss Detection (P_{md}) versus SNR for (ED, CHD $M=20$ and MFD) Methods with various Fading Channels	79
Figure 4-21: Probability of Miss Detection (P_{md}) versus SNR for (MFD, CD and CHD $M=20$) Methods with various Fading Channels	79

Figure 5-1: A Scenario of Cognitive Radio Network to Detect Primary Transmitter	83
Figure 5-2: Block Diagram of the Proposed Model Stages	85
Figure 5-3: Block Diagram of Wavelet-Based MRSS Technique	87
Figure 5-4: Output for Different Primary signal using MRSS Spectrum Sensing Technique	88
Figure 5-5: MRSS result for coarse resolution Sensing	89
Figure 5-6: MRSS result for fine resolution Sensing	89
Figure 5-7: Regions of Observation Energy in the Two-bit Hard Combination	93
Figure 5-8: Regions of Observation Energy in the proposed approach scheme	94
Figure 5-9: Probability of Detection (PD) vs. N_{avg} with number of CR nodes	101
Figure 5-10: Probability of Detection (PD) vs. N_{avg} with Different values of SNR	101
Figure 5-11: Probability of Detection (PD) vs. Number of CR nodes with Different N_{avg}	102
Figure 5-12: Probability of Detection (PD) vs. Number of CR nodes with Different value of SNR	103
Figure 5-13: Probability of Detection (PD) vs. SNR (dB) with Different N_{avg}	104
Figure 5-14: Probability of Detection (PD) vs. SNR (dB) with Number of CR nodes	104
Figure 5-15: Probability of Detection (PD) vs. SNR (dB) with Different Schemes	106
Figure 5-16: Probability of Miss Detection (PMD) vs. SNR (dB) with Different Schemes	106
Figure 5-17: Scenario Cluster Model	110
Figure 5-18: Probability of Detection vs. SNR at the Common Receiver	114
Figure 5-19: Probability of False Alarm vs. SNR at the Common Receiver	114
Figure 5-20: Probability of Miss Detection vs. SNR at the Common Receiver	115
Figure 5-21: Probability of Error vs. SNR at the Common Receiver	116

List of Tables

Table 2-1: Uncooperative versus Cooperative Detection	23
Table 5-1: False Alarm Channel with SNR (dB) for Different Schemes	107

List of Abbreviations

AM	Amplitude Modulation
AP	Access Point
AWGN	Additive White Gaussian Noise
BPPM	Biorthogonal Pulse Position Modulation
BPSK	Binary-Phase Shift Keying
CAF	Cyclic Auto-Correlation Function
CC	Cognitive Cycle
CD	Cyclostationary Detection
CEPT	European Conference of Postal Telecommunication Administrations
CHD	Channelized Detection
CP	Cyclic Prefix
CR	Cognitive Radio
CRoF	Cognitive Radio over Fibre
CRN	Cognitive Radio Network
CSD	Cyclic Spectrum Density
DARPA	Defence Advanced Research Project Agency
DSB-AM	Double Side Bands-Amplitude Modulation
DSSS	Direct Sequence Spread Spectrum
DTT	Digital Terrestrial Television
DVB-T	Digital Video Broadcasting Terrestrial
ED	Energy Detection
EGC	Equal Gain Combination
ETSI	European Telecommunication Standards Institute
FAM	FFT Accumulation Method
FCC	Federal Communication Commission
FFT	Fast Fourier Transformer
FH	Frequency Hopping
GUESS	Gossiping Updates for Efficient Spectrum Sensing
IEEE	Institute of Electrical and Electronic Engineering
IR-UWB	Impulse Radio Based UWB
ITU	International Telecommunication Union
LAN	Local Area Network
LNA	Low Noise Amplifier
LO	Local Oscillator
MAC	Medium Access Control
MFD	Matched Filter Detection
MRSS	Multi-Resolution Spectrum Sensing
OFDM	Orthogonal Frequency Division Multiplexing

PD	Probability of Detection
PHY	Wireless Radio System Physical Layer
PMD	Probability of Miss Detection
PSD	Power Spectral Density
PU	Primary User
PU _s	Primary Users
PPM	Pulse Position Modulation
QoS	Quality of Service
RF	Radio Frequency
RoF	Radio over Fibre
RSSI	Receiver Signal Strength Indicator
SCD	Spectral Correlation Density
SNR	Signal to Noise Ratio
SU	Secondary User
SU _s	Secondary Users
TH	Time Hopping
UWB	Ultra Wide Band
UWB-CR	Ultra Wide Band Cognitive Radio System
UWB-OFDM	Ultra Wide Band based Orthogonal Frequency Division Multiplexing
WiMAX	Worldwide Interoperability for Microwave Access
WLAN	Wireless Local Area Network
WPAN	Wireless Personal Area Network

CHAPTER 1

Introduction

1.1 Motivations

In recent decades, there has been massive increase in wireless communication systems. The usage of frequency bands, or spectrum, is strongly regulated and allocated to specific communication technologies. The enormous majority of frequency bands are allocated to licensed users, which are also steered by standards. There are several organizations working on standards for frequency allocation, such as the European Telecommunications Standards Institute (ETSI), the International Telecommunication Union (ITU) and the European Conference of Postal and Telecommunications Administrations (CEPT).

Spectrum is a scarce resource, and licensed spectrum is proposed to be used only by the spectrum owners. Various studies of spectrum utilization have shown unused resources in frequency, space and time [1]. Cognitive radio is a new method of reusing licensed spectrum in an unlicensed manner [2]. The vacant resources are often referred to as spectrum holes or white spaces. These spectrum holes could be reused by cognitive radios, sometimes called secondary users. There might be geographical positions where some frequency bands are allocated to a primary user system, but not currently used. These unused, geographical spectrum holes could be exploited by secondary users, as shown in Figure 1.1. There might also be certain time intervals for which the primary system does not use the licensed spectrum, as shown in Figure 1.2. These time domain spectrum holes could also prospectively be employed by secondary users.

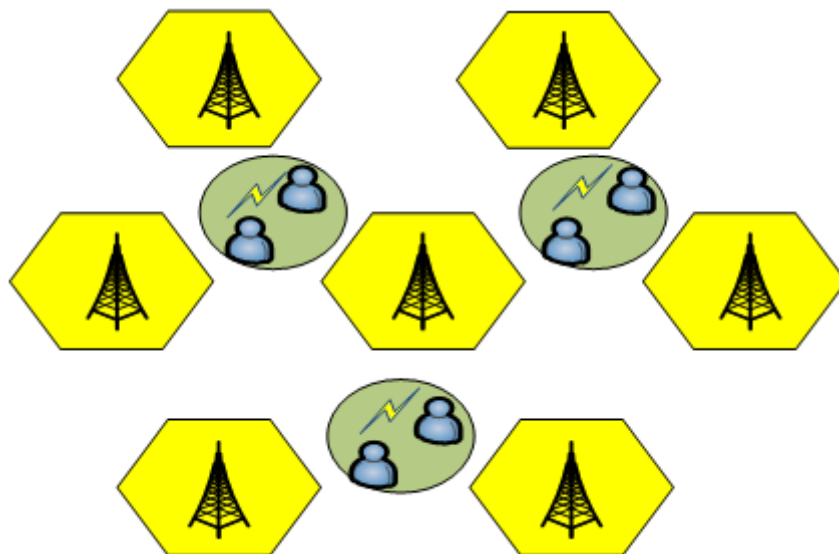

Figure 1-1: Geographical Spectrum Holes.

The introduction of cognitive radios will unavoidably create increased interference and thus degrade the quality of service of the primary system. The effect on the primary system, for example in conditions of increased interference, must be kept minimal. To keep the collision interference at an acceptable level, secondary users must sense the spectrum to detect its availability. Secondary users must be able to detect very weak primary user signals [3]. Spectrum sensing is one of the most fundamental components of cognitive radio.

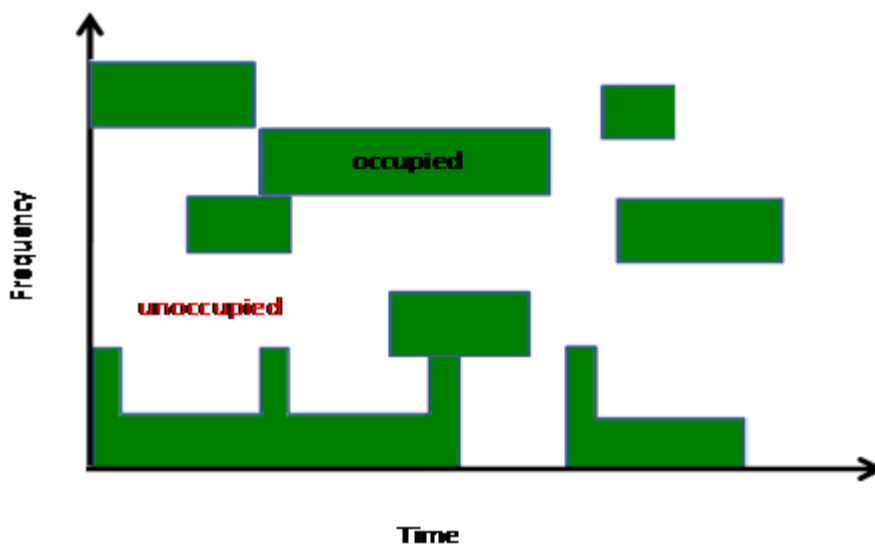

Figure 1-2: Time domain Spectrum Holes.

The research presented in this thesis is motivated by the following issues:

1. Spectrum sensing

Spectrum sensing is considered necessary in cognitive radios in order to find opportunities for agile use of spectrum. Moreover, it is essential for managing the level of interference caused to primary users (PUs) of the spectrum. Additionally, sensing provides intelligence about the radio operating environment. A cognitive radio may then adapt its parameters such as power, carrier frequency and waveforms dynamically in order to provide the best obtainable connection and to meet the user's needs within interference constraints.

2. Cooperative Detection

In a fading environment, however, spectrum sensing is challenged by the uncertainty due to channel fading since the secondary user has to differentiate between a white space, where there is no primary signal, and a deep fade where it is hard to detect the primary signal. Similar difficulties arise in the case of shadowing. To deal with these issues, different secondary users can cooperate to detect the presence of primary signals. The diversity gain achieved through collaboration helps to ameliorate the fading and shadowing effects. Cooperative sensing also helps in improving the detection performance [4].

1.2 Aims and Objectives

The research aims in this thesis are summarized as follows:

1. To develop a new strategy for recognizing channel users and providing flexible and dynamic spectrum utilization, by using the cyclostationary detection method, which is one of the spectrum sensing techniques in wireless base stations.
2. To provide good spectrum sensing performance and reliable detection with less information knowledge from the primary user by considering different spectrum sensing methods with various fading environments in UWB-CR systems.

3. To develop a new technique at the fusion centre for cooperative sensing which reduces the time sensing delay and amount of data needed to make a reliable final decision.
4. To reduce the reporting error and to improve the sensing performance by using the clustering method.

The research primarily focuses on achieving the following objectives:

1. Combining cognitive radio functions with other wireless technologies brings some advantages to wireless networks, such as a certain CR may transmit illegally falls outside the current definitions of cognitive networks. Additionally, cognitive radios can use their technical advances to adapt their carrier frequencies to transmit on a certain channel when the primary user is not operating. FAM is presented as the algorithm for cyclic spectrum analyzing. This method is derived from the cyclostationary detection technique which is widely accepted as the most effective sensing procedure for cognitive radios.
2. The second objective in this thesis is to evaluate and study numerous spectrum sensing detection methods for detecting primary signals in ultra wide band cognitive radio systems (UWB-CR), with different fading environments and to select a reliable method to use in the UWB-System. The various detectors, such as Energy detectors, matched filter and feature cyclostationary detectors are considered and their results compared.
3. The third objective is to implement collaborative spectrum sensing in Cognitive Radio Networks. The aim is to determine the frequencies of the signals in the air. Additional objectives are to reduce the computational complexity, decrease error reporting detection information with cluster cooperative detection and increase the sensing performance.

To achieve these objectives, a cognitive radio network and clustering cognitive radio network based collaborative wideband spectrum sensing scheme are proposed. This scheme uses a wavelet-based multi-resolution spectrum sensing

(MRSS) method for spectrum sensing, a modified new two-bit hard combination technique for collaboration detection.

1.3 Contribution to Knowledge

This thesis follows the single antenna terminal methods. The key contributions are summarized as follows:

1. A method for real-time detection of secondary users at the base station. Cognitive radios may hide themselves in between the primary users in one channel without SNR or between the primary users and rental secondary users under different SNR conditions. To deal with such scenarios to detect the hiding cognitive radio users and for QoS of the cognitive radio and other primary license networks operating is same converge area. These proposed models are discussed as follows:
 - a. Cyclostationary Fast Fourier Transform FFT Accumulation Method (FAM) has been used to develop a new strategy for the recognition of channel users.
 - b. Channels users are tracked according to changes in their signal parameters, for instance modulation techniques.
 - c. Testing different kinds of primary and secondary signals transmitted in one channel under different values of SNR.
 - d. Using the FAM technique, the obtained spectral correlation density function shows successful recognition between different signals with and without different values of SNR.
2. To compare different spectrum sensing methods, the detection performances are investigated for detecting primary signals in different fading channels in the UWB-CR system.
 - a. Detection methods such as Energy detection, matched filter detection, cyclostationary detection and channelized receiver detection are used to detect primary users with different fading environment.

- b. The different noise channels models with AWGN, shadowing channel, Rayleigh channel and Ricean channel are used to investigate the detection performance of different detectors.
3. To improve detection performance among the cognitive radio nodes and also increase the life of the nodes by decreasing the detection time required. We propose a collaborative wideband spectrum sensing and cluster-based cooperative wideband spectrum sensing in cognitive radio networks.
 - a. The scheme uses a wavelet-based multi-resolution spectrum sensing (MRSS) method to determine the primary signals, unoccupied and weak channels in the air, and a modified two-bit hard combination method for cooperation.
 - b. With the MRSS technique, sensing time and power are decreasing significantly because with this technique, the whole bandwidth of the system is not examined comprehensively [5].
 - c. An additional aim is to use the above scheme to maximize the sensing performance and minimize the computational complexity and reduce the error reporting in the cluster method.

1.4 Research Methodology

The proposed models and a range of components were designed and simulated in MATLAB[®] software. MATLAB[®] offers an easy interactive environment and fast mathematical algorithms. It allows matrix handling, plotting of functions and data, and algorithm implementations.

1.5 Structure of Thesis

The thesis consists of six chapters. Chapter 2 gives an introduction to the spectrum sensing techniques in cognitive radio applications, specifically focusing on the issues to which the later three chapters will refer. The aim is to supply sufficient information to understand the spectrum sensing techniques in cognitive radio applications. A background of cognitive radio, previous work and the most common types of the cognitive radio

function are discussed in detail, and the reasons behind applying spectrum sensing techniques in cognitive radio systems are examined.

Chapter 3 explains a method for real-time detection of secondary users at the base station of wireless networks; the method aims to reduce the likelihood of secondary users making use of the channel bands at the right time without paying for the service. The method can increase the capacity of wireless networks by servicing primary and secondary users. A cyclostationary detection-based spectrum sensing method is used, which monitors the presence of users in the radio channels and ensures that the secondary user nodes will not access spectrum without permission. Another benefit can be provided by combining the CR function with wireless techniques, improving system reliability by utilizing spectrum without causing interfering to different users.

Based on the other model, chapter 4 describes the main spectrum sensing techniques of cognitive radio application. The performance of spectrum sensing methods of the UWB-CR system for detecting primary signal users in AWGN and different fading channels is proposed, which is an extension to the UWB-CR system; it works efficiently using the reliable spectrum sensing method with higher detection performance. The model implemented different spectrum sensing methods under various fading channels; detection results show the performance of methods under such environments, and which technique can be selected for use in the UWB-CR systems.

Chapter 5 focuses on cooperative spectrum sensing in cognitive radio networks, and proposes two models, the first considers collaborative wideband spectrum sensing in cognitive radio network, and the second studies cluster-based cooperative wideband spectrum sensing. The Multi Resolution Spectrum Sensing (MRSS) method and the modified two-bit hard combination schemes are used to improve detection performance and reduce error detection in cluster models. By deploying CR nodes and grouping the CR nodes in an area, every CR node sends information concerning the presence of primary transmitters to the decision node that makes the final detection decision or sends to the common receiver in the cluster model for the final decision, which is based upon detection performance under different scenarios, such as the number of cognitive radio nodes, different average powers of the received signal and signal to noise ratio, as investigated in the first proposal model. Additionally, the detection performance of the proposed approach is compared

with traditional hard combination schemes. The proposed methods show better detection performance for both the employed cooperative models.

Finally, Chapter 6 summarizes the work and presents several ideas for future research.

CHAPTER 2

Cognitive Radio System

2.1 Cognitive radio: BACKGROUND

Cognitive Radio (CR) is a form of wireless communication in which a transceiver can intelligently detect the spectrum band in which channels are in use and which are not, and can then instantaneously move to vacant channels thus avoiding occupied ones. This optimizes the use of available radio-frequency (RF) spectrum whilst reducing interference to other users. The main objectives for cognitive radio are highly reliable communication wherever and whenever needed, and efficient utilization of the radio frequency spectrum.

The idea behind cognitive radio was first presented by Joseph Mitola at the Defence Advanced Research Project Agency (DARPA) in the United States [6]. Radio spectrum is a natural resource, the exploitation of which is licensed by government. In November 2002, the Federal Communications Commission (FCC) published a report by the spectrum-policy task force [7], which showed that radio spectrum is extremely underutilized. Cognitive Radio offers a novel technique of solving this underutilization problem [8-10].

2.1.1 Main Functions

1. Spectrum Sensing: this is a fundamental function in CR to enable cognitive radio users (CRs) to detect the underutilized spectrum of primary systems and improve overall spectrum efficiency.
2. Spectrum Management: functions are required for CR to achieve users' communication needs by capturing the best available spectrum; CR should

decide on the best spectrum band and the channels within it to meet the QoS requirements over all available spectrum channels.

3. **Spectrum Mobility:** this is the process whereby cognitive radio users change their frequency of operation. Cognitive radio networks aim to use the spectrum dynamically by allocating the radio terminals to operate in the greatest available frequency channels.
4. **Spectrum Sharing:** this is one of the main challenges in open spectrum usage, providing efficient and fair dynamic spectrum allocation methods to distribute the unoccupied spectrum of primary users to the competitive secondary users.

2.1.2 The Cognitive Cycle

The cognitive cycle consists of three main mechanisms: (a) sensing the Radio Frequency (RF) spectrum; (b) cognition / management, and (c) control [6].

1. **Spectrum Sensing:**
 - Detection of unused spectrum bands or estimation of the total interference in the radio environment.
 - Estimation of channel state information (Signal to Noise Ratio (SNR)).
 - Expectation of channel capacity for use by the transmitter.
2. **Cognition / Management:**
 - Spectrum management which controls opportunistic spectrum access.
 - Traffic shaping.
 - Routing.
 - Provisioning Quality of Service (QoS).
3. **Control action**
 - Adaptive coding and modulation.
 - Control of transmission power.
 - Control of transmission rate.

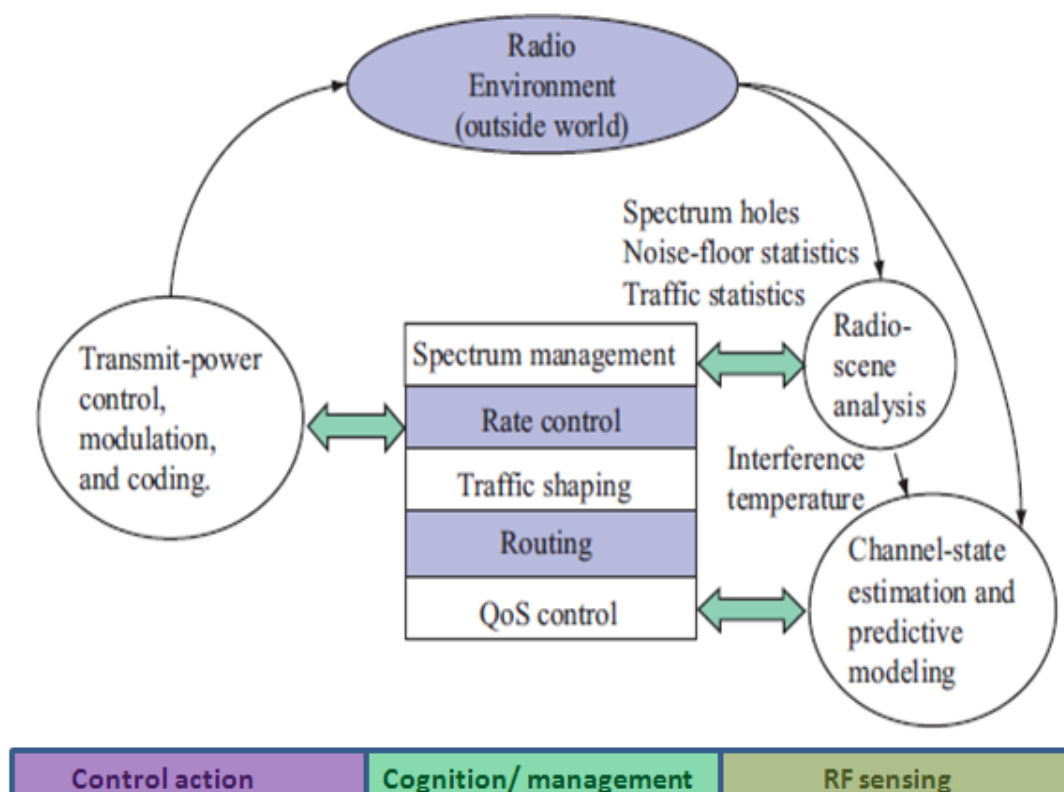

Figure 2-1: Fundamental Cognitive Cycle [9].

Task 1 (RF sensing) deals with spectrum sensing, physical layer issues and is described in the next three chapters. Task 2 (cognition management) undertakes dynamic spectrum allocation, using Game theory. Figure 2.1 shows the tasks in the Cognitive Radio Cycle (CC)..

2.2 Spectrum Sensing

One of the most important elements of cognitive radio is its capability to measure, sense, learn and be aware of the radio channel's characteristics and parameters . Users who have the highest priority on the use of a specific part of the spectrum are defined as primary users; users who have lower priority are defined as secondary users. Secondary users reuse this spectrum in such a way that they do not cause harmful interference to primary users. Therefore, secondary users need to have CR capabilities such as spectrum sensing in order to detect available channels in the RF spectrum and thus exploit the vacant part of spectrum (spectrum 'white space').

'Spectrum sensing' is the most important function for cognitive radio management. Usually understood as determining the spectral content, or measuring the interference temperature over the spectrum, spectrum sensing involves obtaining the spectrum usage characteristics across multiple dimensions such as frequency, code space and time. It also characterises the type of signals that occupy the spectrum, including the carrier frequency, modulation and bandwidth.

2.2.1 Challenges & Spectrum Sensing

Challenges related to spectrum sensing for cognitive radio are:

- Hidden primary users problem: this problem can be caused by multipath fading and shadowing, causing secondary users to fail to detect the existence of primary users. As an example, Figure 2.2 below shows the hidden node problem - the signal from the primary transmitter cannot be detected, because of the location of the cognitive radio devices; this will cause unwanted interference to the primary user if cognitive radio devices try to access this occupied spectrum.
- Sensing time: in order to avoid interference to and from primary users (licensed), cognitive radio users (unlicensed) must be able to recognize the presence of primary users as quickly as possible and should leave the band immediately. This creates performance limits on the spectrum sensing methods for cognitive radio design.

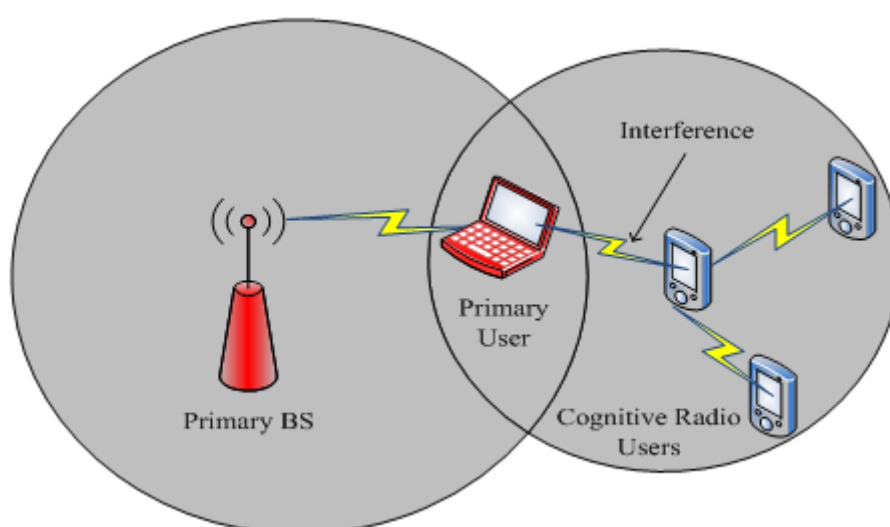

Figure 2-2: Hiding Primary User Problem in Cognitive Radio System.

Other challenges that need to be considered when designing spectrum sensing methods include power consumption, competition, robustness, cooperation, computational complexity, coherence times and the presence of multiple secondary users.

2.2.2 Multi-dimensional Space for Spectrum Sensing

There are a variety of RF spectrum dimensions/parameters to consider, which are summarised below with their corresponding measurement sensing requirements [11].

1. Frequency:

By assessing/measuring the frequency usage of channels will allow determination of available spectrum; some parts of bands might be available for opportunistic use.

2. Time:

Sensing the usage of spectrum in the time domain will determine vacant time slots for opportunistic use. Figure 2.3 shows the usage opportunity in the frequency and time domains.

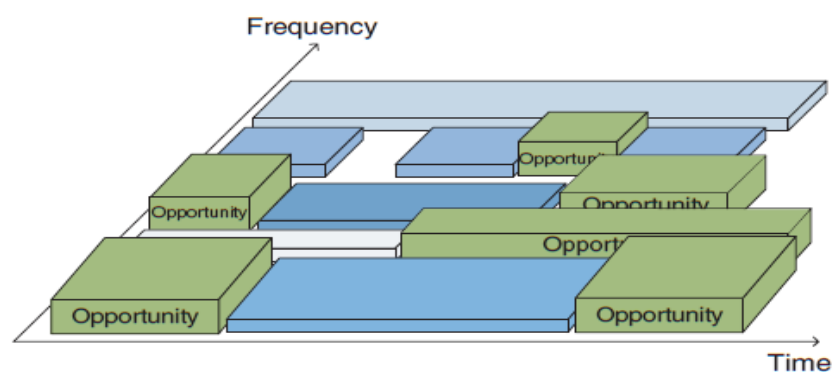

Figure 2-3: Spectrum Opportunity in the Frequency and Time domain Dimensions [11].

3. Geography:

At any given time the spectrum might be occupied in some fraction of the geographical area whilst it is available in other locations. CR can take advantage of propagation loss (path loss) since the signal strengths of primary users may be sufficiently low. The required measurements depend on interference temperature, i.e., we can determine the existence of a primary

transmission in a local area from the location of interference existing in that area. However, the problem of hidden terminals may exist that requires a careful determination and decision. Figure 2.4 shows two areas A and B; region A can be used by secondary CR users.

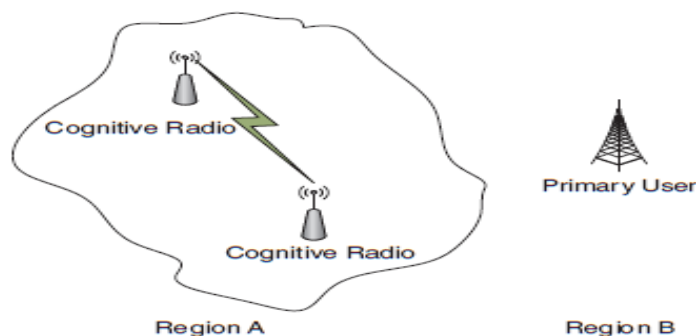

Figure 2-4: Spectrum Opportunity in the Geographic Dimension [11].

4. Code Dimension:

Figure 2.5 below shows the spectrum usage opportunity for CR in the code dimension. Wideband spectrum may be in use through spread spectrum and frequency hopping techniques. Within the code domain simultaneous use avoiding interference with primary users is possible. It is necessary to determine the used codes and multipath parameters such as frequency hopping (FH), time hopping (TH) and spreading codes.

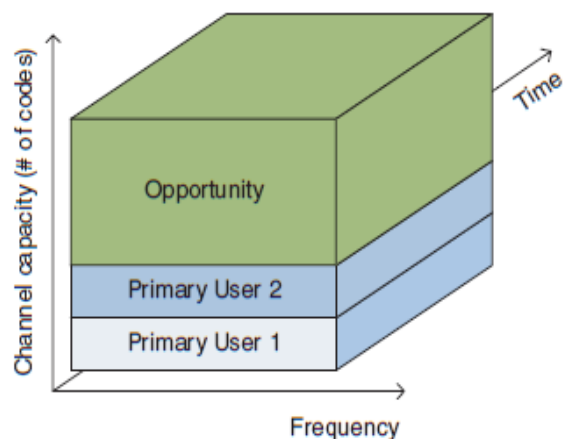

Figure 2-5: Spectrum Opportunity Code Dimension [11].

5. Angle Dimension (Directionality):

Spectrum usage opportunities may be created from knowledge of the location and position of the primary users' signal direction. This can allow secondary users to transmit in a different direction distinct from the primary user's direction thus avoiding interference with the primary user. Figure 2.6 illustrates this.

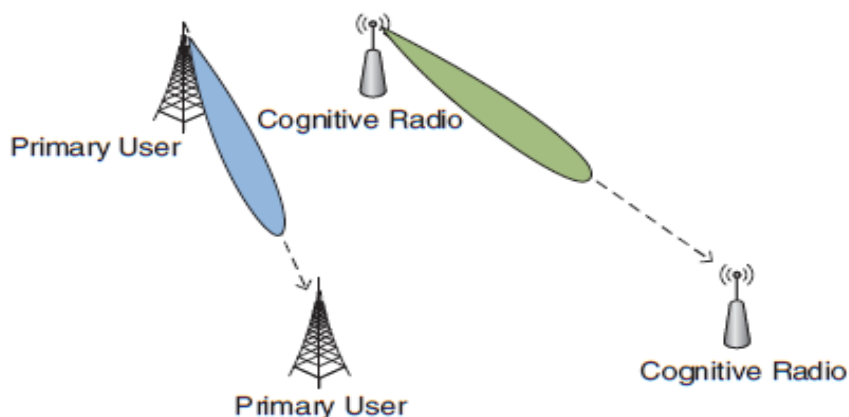

Figure 2-6: Spectrum Opportunity in Angle Dimension [11].

6. Signal Dimension (Orthogonality):

Secondary users and primary users may be transmitting simultaneously in the same band and geographical area. Transmitting a signal orthogonal to the primary user, the secondary user can establish communications without interfering with primary users. This needs waveform identification. Figure 2.7 shows this spectrum usage opportunity.

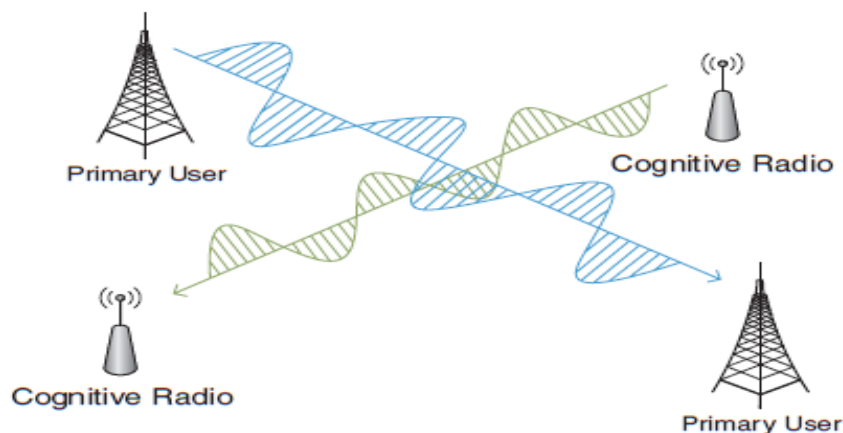

Figure 2-7: Spectrum Opportunity in Wave Dimension [11].

2.2 Spectrum Sensing Techniques

As previously mentioned, spectrum sensing may be defined as scanning and examining the RF spectrum to determine occupied and unoccupied bands to exploit unused frequency bands for cognitive radio communications. Spectrum sensing technique can be classified into two categories [11], as described below.

2.3.1 Uncooperative Spectrum Detection (Transmitter Detection)

The cognitive radio user must be able to determine whether a signal from a primary user is locally present in the spectrum band(s) of interest. Below is an overview of the three well-known spectrum sensing methods for a single cognitive radio user, as reported in the literature.

2.3.1.1 Energy Detection

The technique of energy detection is optimal for the detection of any signal and can be applied to cognitive radio users [12]. In energy detection received signal strength indicator (RSSI) is determined. The received signal is measured over an observation time in order to detect the presence of the signal. As seen in figure 2.8, the received signal is filtered, converted to digital form, squared and integrated over the observation interval. The energy output of integrator is then compared with a threshold to decide on the presence or absence of a primary user, i.e., a binary decision is made:

$$\begin{cases} H0, & \text{if } \sum_{n=1}^N |y[n]|^2 \leq \lambda \\ H1, & \text{otherwise} \end{cases} \quad (1 - 1)$$

where λ is the threshold which depends on the receiver noise.

Although energy detection can be implemented without any a priori knowledge of the primary user signal, the technique has some problems. Firstly, it can only detect the signal of the primary user if the detected energy is greater than the threshold. The choice of the threshold level is not straight-forward, since it is highly susceptible to the changing background noise and interference, especially. A second difficulty is that the energy approach cannot distinguish the primary user from other secondary users sharing the same channel. This is a critical challenge when the primary users of multiple systems co-exist in

cognitive radio networks, which we discuss later. The third problem occurs at low signal-to-noise ratio (SNR), e.g., at an SNR of -40dB, the energy detector requires more detection time compared to the match filter detector.

Multi-resolution spectrum sensing is a kind of energy detection based sensing technique and is an improved energy detector [13]; this detector is presented in Chapter 5.

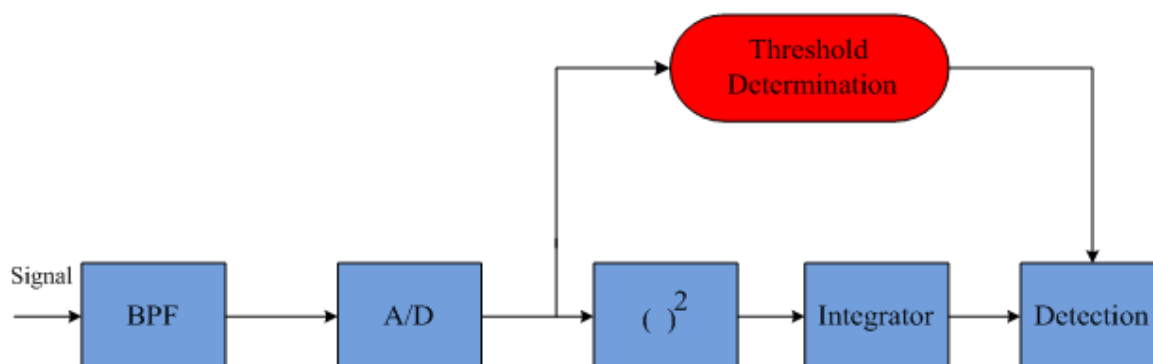

Figure 2-8: Implementation of an Energy Detector.

2.3.1.2 Matched Filter Detection

When the transmitted signal is known, the optimum spectrum detection technique is the matched filter detector [14]. Matched filter detection uses a priori knowledge of the received signal, such as frequency, bandwidth, modulation type, pulse shaping, etc. [15]. Figure 2.9 shows an implementation of the matched filtering technique; the pilot signal provides a priori knowledge of the primary signal. To detect the primary user signal, the pilot is correlated with the received signal and then compared to a threshold to determine the presence of the primary user signal (a binary decision), as shown in the equation below.

$$\begin{cases} H_0, & \text{if } \sum_{n=1}^N y[n]x[n]^* \leq \lambda \\ H_1, & \text{otherwise} \end{cases} \quad (1-2)$$

where λ is the threshold.

To achieve a certain probability of missed detection or false alarm positives, matched filtering requires a shorter detection time compared with cyclostationary detection and energy detection. The main disadvantage in the matched filter approach is the

requirement for a priori knowledge. A further disadvantage is the need for synchronization between transmitter and receiver. Additionally, the correlation adds significantly to the implementation complexity.

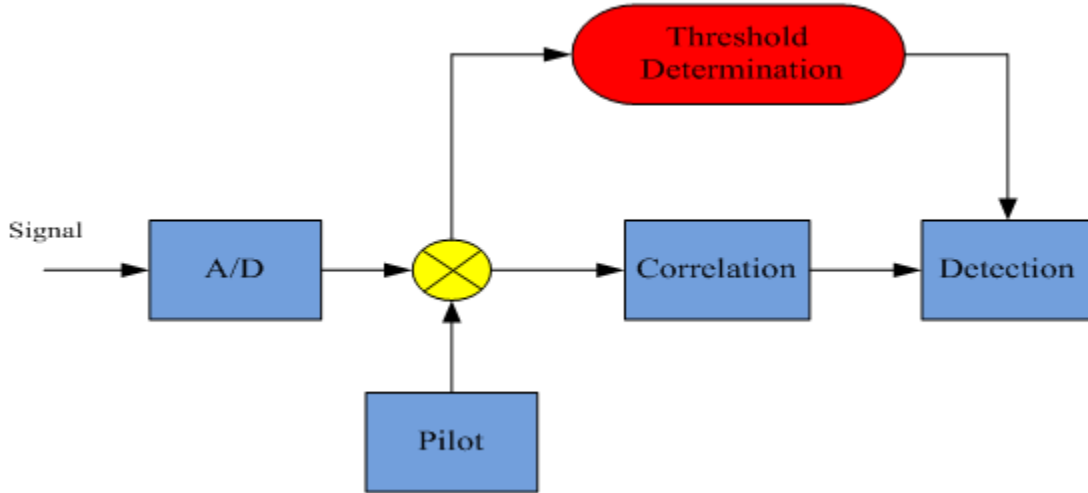

Figure 2-9: Implementation of a Matched Filtering Detector.

2.3.1.3 Cyclostationary Detection

The cyclostationary feature of the modulated primary user signals is exploited in the cyclostationary detection technique [16]. Cyclostationary features are caused by periodicity of the modulated signal, such as sine wave carriers, pulse trains, hopping sequences, cyclic prefixes, or repeated spreading. Modulated signals are cyclostationary with spectral correlation, due to the in-built periodicity. Figure 2.10 shows implementation of the cyclostationary sensing technique. The figure shows that the spectral mechanisms of the input signal are calculated through the fast Fourier Transform (FFT) [13], as:

$$R_x^\alpha(\tau) = \lim_{T \rightarrow \infty} \frac{1}{T} \int_{-T/2}^{T/2} x\left(t + \frac{\tau}{2}\right) x\left(t - \frac{\tau}{2}\right) e^{-j2\pi\alpha t} dt \quad (1 - 3)$$

Then the spectral correlation function (SCF) is estimated by spectral correlation performed on these spectral components.

$$S_x^\alpha(f) = \int_{-\infty}^{\infty} R_x^\alpha(\tau) e^{-j2\pi f\tau} d\tau \quad (1 - 4)$$

It is shown specifically that

$$S_x^\alpha(f) = \lim_{T \rightarrow \infty} \lim_{Z \rightarrow \infty} \frac{1}{TZ} \int_{-Z/2}^{Z/2} X_T\left(t, f + \frac{\alpha}{2}\tau\right) X_T^*\left(t, f - \frac{\alpha}{2}\tau\right) dt \quad (1-5)$$

where

$$X_T(t, f) = \int_{t-T/2}^{t+T/2} X(u) e^{-j2\pi fu} du \quad (1-6)$$

This spectral correlation function $S_x^\alpha(f)$ is also called cyclic, which is a function of two dimensions (frequency and cyclic frequency (α)). The spectrum is analyzed by searching for the unique cyclic frequency α matching the peak in the SCF and deciding whether the signal of primary users are detected. The next chapter provides further details about the use of the Cyclostationary Fast Fourier Transform Accumulation Method (FAM).

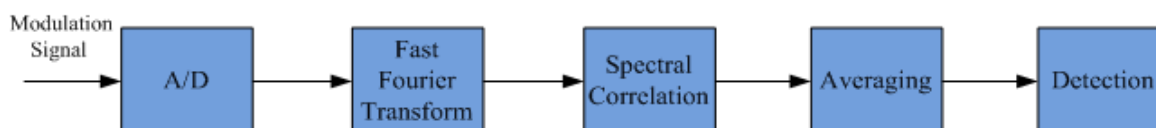

Figure 2-10: Implementation of Cyclostationary Feature Detector.

2.3.2 Cooperative Spectrum Detection:

Spectrum sensing may be conducted locally by one cognitive radio user; the idea behind cooperative spectrum sensing is that this data can be combined from different cognitive radio users.

There are many problems that cooperative spectrum detection can solve, such as those that arise fading and shadowing noise uncertainty; it decreases the probability of false alarms and miss-detection, decreases sensing time and solves the problem of hidden primary users[17]. These difficulties are summarized below.

- **Received and shadowing uncertainty spectrum detection problem:**

Due to the lack of information about the signals from primary transmitters (see Figure 2.11(l)), the cognitive radio user alone cannot avoid causing interference to primary users since the CR user cannot detect the primary transmitter.

A further problem is that the cognitive radio may have a good line of sight to a primary transmitter, but may be unable to detect the signal from the primary transmitter,

because of shadowing as shown in Figure 2.11(II). Other cognitive radio users sensing information is required for a more reliable primary transmitter signal detection, this is referred to as comparative spectrum detection.

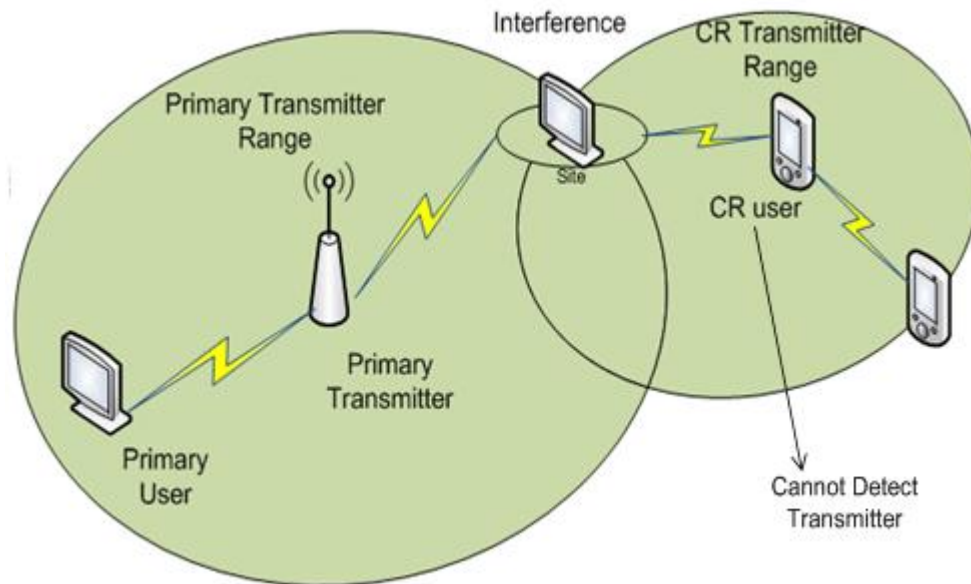

(I)

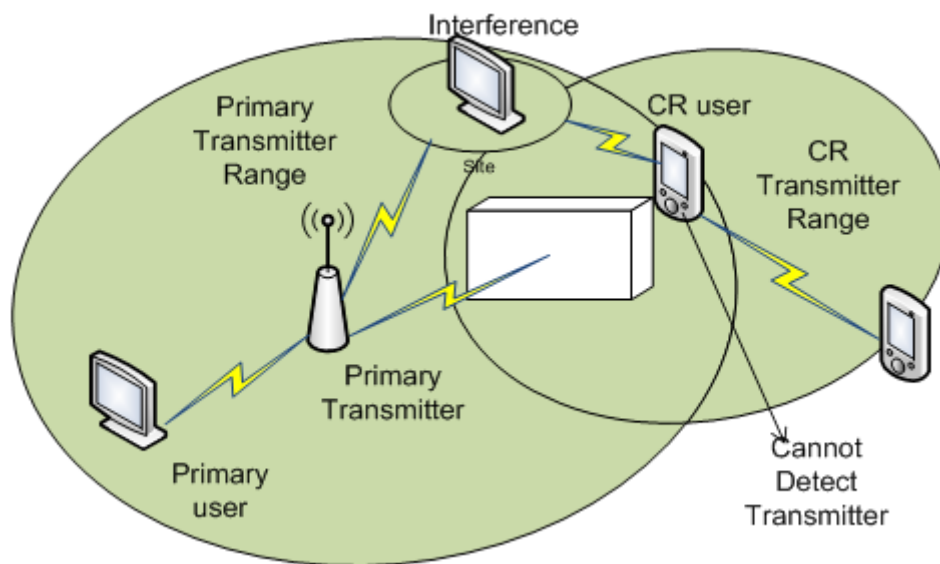

(II)

Figure 2-11: Primary Transmitted Detection: (I) Receiver uncertainty and (II) Shadowing uncertainty.

- **Cooperative primary transmitter detection under faded and shadowed problem:**

As shown in Figure 2.12, let us assume that there are many CR users. Because of multipath fading, with the low SNR, CR user 2 receives a weak signal and it cannot detect the signal from the primary transmitter. CR user 1 also cannot detect the signal of the primary user, because it is in the shadowing area.

The only one that can detect the primary transmitter is CR user 3. So, CR user 1 and CR user 2 make their decisions to transmit on their local operations, causing interference to the primary user. However, by exchanging sensing information between the CR users (1, 2 and 3), even though they are under fading and shadowing conditions, all CR users can detect the existence of the primary user.

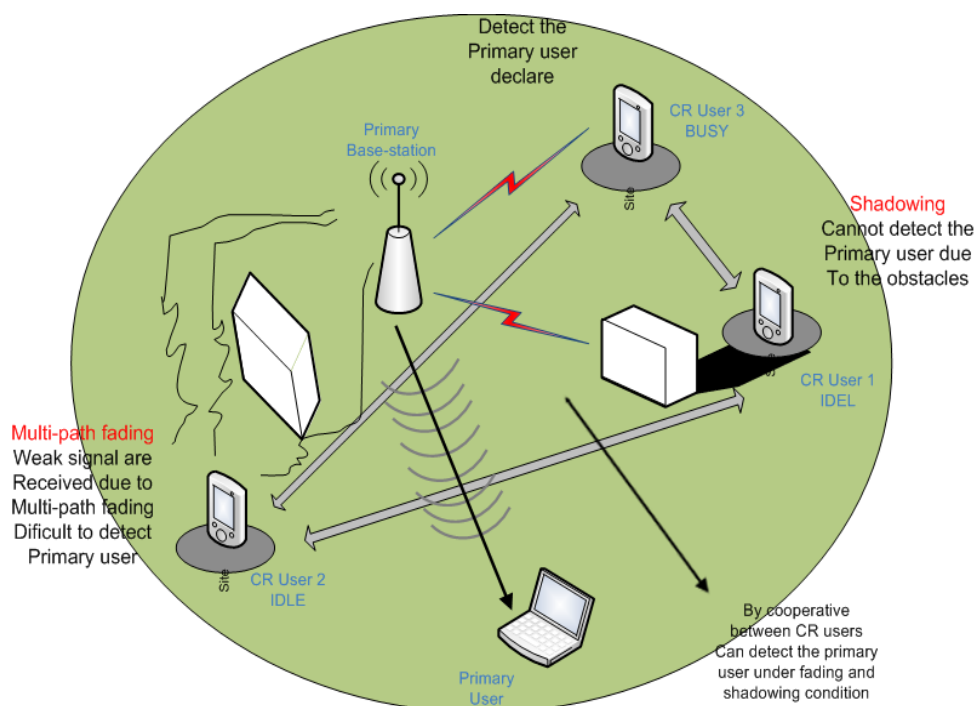

Figure 2-12: Cooperative Primary Transmitter Signal Detection under high faded and shadowed problem.

- **Sensing Time problem:**

One of the main advantages in cooperative detection for multi CR users is decreasing the sensing time. Spectrum sensing precision by a single CR user increases with the time of sensing. Because of the sensing capabilities of CR users, a suitable precision may be

achieved after long sensing times. In some cases the uncertainty in noise, sensing times may approach infinity. This problem has led to the idea of cooperative sensing techniques.

Table 2-1 below shows the advantages and disadvantages of non-cooperative and cooperative spectrum detection techniques.

Table 2-1: Uncooperative versus Cooperative detection

<i>Sensing Technique</i>	<i>Advantages</i>	<i>Disadvantages</i>
<i>Uncooperative Detection</i>	❖ <i>Simplicity of implementation</i>	❖ <i>hiding nodes problem</i>
<i>Cooperative Detection</i>	<ul style="list-style-type: none"> ❖ <i>High accuracy</i> ❖ <i>Reduced sensing time</i> ❖ <i>No problem with hiding and shadowing</i> 	<ul style="list-style-type: none"> ❖ <i>Higher complexity of system collaboration and of sensor</i> ❖ <i>Overhead traffic</i>

Cooperative spectrum detection can be implemented either centralized or distributed [4].

2.3.2.1 Centralized Sensing Method:

In this method, the Access Point (AP), such as the master node or base station collects sensing information from the cognitive radio users and makes a decision on whether the primary signal is present and delivers this information to other cognitive radio users. The aim is to increase detection performance by mitigating fading effects of the channel [18]. However, the sensing information can be classified into hard and soft information combining tasks as explained in more detail in Chapter 5. These information combining tasks can be investigated for increased probability of detection and decreased probability of miss-detection. However, Chapter 5 illustrates the hard combination method for miss-detection.

2.3.2.2 Distributed Sensing Method:

In this method cognitive radio users make their own decision, adding to the information shared between each CR user. However, with the distributed sensing method,

there is no need for a backbone infrastructure, which is the main advantage of this method compared to the centralized sensing method.

Research has been conducted concerning the distributed sensing method [4] such as the Gossiping Updates for Efficient Spectrum Sensing (GUESS) algorithm: this is proposed for performing efficient coordination between cognitive nodes in distributed cooperative sensing. This algorithm has low complexity with reduced overhead, is robust to changing networks and has fast convergence.

The proposed second algorithm of the distributed cooperation method performs cooperation between two cognitive users in different locations. One cognitive user is located closer to the primary signal transmitter and has a better chance to detect primary user transition and cooperate with another cognitive user which is further from the primary transmitter.

Multi-cognitive radio nodes can share sensing information amongst themselves by the distributed sensing method, in order for the cognitive radio users to share the final decision that achieves reducing network overhead due to the cooperation. If any one of cognitive user nodes sends to the other user nodes H1 (meaning that the node has decided that the signal of the primary transmitter is present), then the final decision made is that the signal of the primary transmitter is present for all CR users, this fusion rule is known as the OR-rule.

The distributed sensing method research using cooperative detection shows that performance improvements can be achieved.

2.3.3 Primary Receiver Detection:

Cooperative decision-making can minimize the probability of interference. The best way to detect spectrum holes is by detecting the primary users that are receiving signal within the local communication of the cognitive radio users rather than detect the primary transmitter's signal. Figure 2-13 shows that the primary receiver usually emits local oscillator (LO) leakage power from its radio frequency (RF) circuitry. To determine the available unoccupied channels, a secondary receiver detection technique exploits this local oscillator (LO) leakage power to detect the signal from the primary receiver user directly instead of from the

primary transmitter. As in TV receivers or supporting sensor network hardware to the cognitive radio, users in the region with the primary receivers is needed.

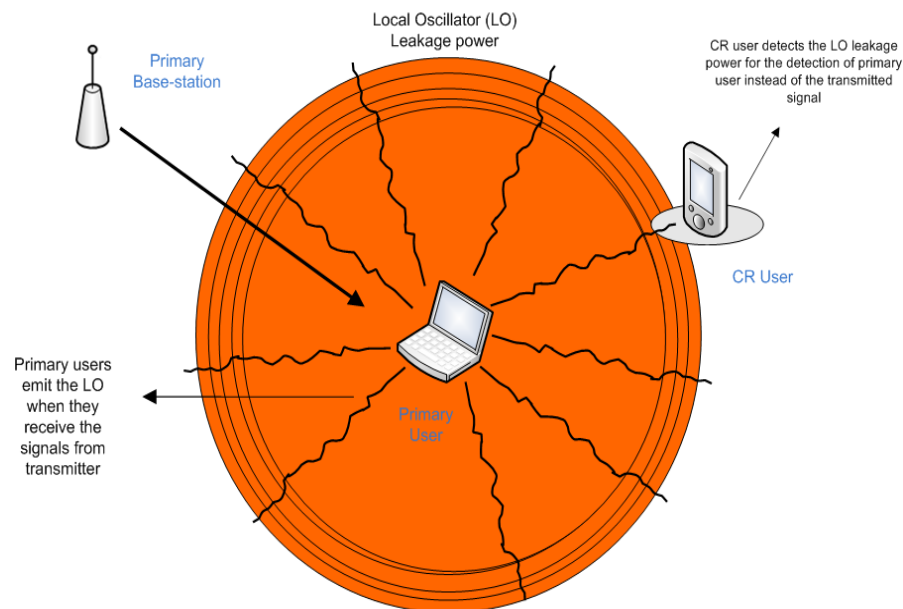

Figure 2-13: Primary Receiver Detection.

2.4 Limitations and Challenges in Spectrum Sensing

The field of spectrum sensing motivations for further research in this field are investigated. Jaekwon Lee proposed cyclostationary feature based detection technique that enhances the spectrum sensing measurements. In this approach, the proposed spectrum method is to detect unused spectrum in low SNR, whilst its overall complexity is almost the same as the cyclostationary feature based detection method. Also, this work does not require prior knowledge of the channel or noise information. In [19], adaptive wavelet based edge detection method as a modification to the traditional spectrum sensing techniques is considered. Furthermore, the adaptive algorithm which selects a suitable wavelet scheme by analyzing the nature of spectrum was conducted in this work.

There is much research on wideband spectrum sensing. A wideband spectrum sensing arrangement should be adapted to scan multiple bands at a time. In [20], B. Farhang proposed a filter bank scheme for wideband spectrum sensing in cognitive radio applications. In this approach, for the cognitive radio networks multicarrier communications

are assumed to be used, the wideband spectrum is presented as the output of a bank with different shifted central frequencies. Fanzi, Zhi and Chen were the first to utilize the radio signal by introducing CS to realise wideband spectrum sensing; the design takes advantage of using less samples closer to the information rate, rather than the converse of the bandwidth to implement wideband spectrum sensing. Wavelet based detection was used to detect the wideband spectrum. In [21], Axell and Larsson considered spectrum sensing of OFDM signals in an AWGN channel by detection of the OFDM signal with a CP of known length. The techniques can be used stand-alone, or they can represent building blocks in a larger spectrum sensing architecture.

In UWB-CR system, research has been focusing on coexistence between UWB system and other wireless technologies such as, WiMAX and WiFi. To explore this issue, combining CR technology with UWB is proposed. In [22], the authors proposed a spectrum sensing algorithm based on Neyman-Person criterion to explore the issues in Coexistence between a cognitive UWB system and WiMax. The authors used an energy detection detector for spectrum sensing to ensure that UWB devices would not interfere with primary users by reliably detecting the primary user signal. Andrea-Tani and Pomano Fantacci focused on a cognitive radio approach based on spectrum sensing method to allow coexistence between UWB and WiMAX [23]. In particular, the authors exploited the cyclostationary property of WiMAX signals to the Cyclic Prefix. In [24], the authors were interested in determining the possible gains in detection performance and improving the UWB system capability to detect the primary transmitter when taking interdependencies into account for practically implementable detection schemes.

In cooperative spectrum detection much research has been conducted with different approaches to solve the detection hiding primary transmitter problem under fading channel conditions. Cooperative spectrum sensing in which a group of cognitive radios collaboratively sense the spectrum through energy detection and introduce the optimality of cooperative spectrum sensing to improve detection performance in an efficient and implementable way is investigated in [25]. The authors considered the optimal voting rule for any detector applied to cooperative spectrum sensing and they employed optimization of the detection threshold when implementing an energy detector.

Kamran-Arshad and Muhammad-Ali studied optimization of collaborative spectrum sensing in terms of optimum decision fusion for soft and hard combination schemes. In this approach, correlated long-normal channel noise shadowing among cooperative users is considered and they show in their paper that correlated shadowing has a direct impact on the optimal fusion rule at the common centre. In [26] the distribution of the ratio of extreme eigenvalues of a complex Wishart matrix is employed. The authors considered the maximum-minimum eigenvalue detector in order to measure the precise decision threshold as a function of the required probability of false alarms. Moreover, the authors show that in the scheme the probability of detection achieves significantly improved performance compared to the performance of just utilising the decision threshold.

CHAPTER 3

Cyclostationary Detection of Hidden Cognitive Radio Users

3.1 Introduction and Motivation

Developments in software radio are continuing, since the cognitive radio defined by [27] is the best considered solution for nearby spectrum crowding. Traditionally, the use of RF bands has been regulated in most countries through the process of spectrum allocation in which the use of a particular frequency band is restricted to the licence holders of the band. Within this framework, spectrum has often been viewed as a scarce resource in high demand. However, measurements have suggested that most licensed spectrum is often under-utilized with large spectral holes at different places at different times [28]. According to an OFCOM consultation report [29], a substantial amount of spectrum, termed as, “white space,” is obtainable subject to time and location. The report shows that over 50% of locations are likely to have more than 150 MHz of interleaved spectrum available and that even at 90% of locations around 100 MHz of interleaved spectrum might be available. In addition, the shifting of the Digital Terrestrial Television (DTT) spectrum eases OFCOM’s task to clear many bands, such as the 800 MHz (channels 61-69) for future cognitive radios.

On the other hand, wireless systems are based on fixed spectrum allocations, allocated fixed spectral bandwidth to licensed users at any time, which leads to sub-optimal use of scarce and expensive spectral resources, resulting in inefficient spectrum utilization. Dynamic spectrum access techniques secure greater spectral-usage efficiency and enhanced access to frequency spectrum based on spectrum pooling [30]. Spectrum pooling is a resource sharing strategy that allows the licensed owner to share a proportion of his licensed spectrum with rental secondary users [31], cognitive radio users are absent until the licensed user is not using the spectrum. The goal of spectrum pooling is to improve spectral efficiency by overlaying new wireless radio systems on a licensed one (the primary users) without interfering with the primary users, and without changing their operations. In

order to keep existing users without harmful interference with rental users, cognitive radio technology must have the ability to detect unused spectrum, a very important process in spectrum pooling system. Therefore, our strategy, explained in later sections, for detecting hidden secondary users will be useful for a spectrum pooling system.

As previously mentioned, one of the most important issues for cognitive radio technology is spectrum sensing, because the CR system needs to recognize the radio environment. If the spectrum sensing does not work properly, the CR system will have inaccurate data about the radio environment, and the system will try to use the same spectrum concurrently with a primary user. This results in several performance degradations for both the cognitive radio system and the primary user [32].

3.2 Scenarios to Detect Hidden Cognitive Radios

There are two scenarios that undefined cognitive radio users need to detect that have been considered: the first scenario is detecting the undefined cognitive radio user in one primary user channel under free SNR, and the second is detecting an undefined cognitive radio users under low SNR conditions. Spectrum sensing continues to emerge as an essential topic for cognitive radio networks where two kinds of users, primary and secondary, will share the band. This chapter proposes methods for real-time detection of secondary users at the base station.

The main idea for the scenarios is that cognitive radios may hide themselves in between the primary users, or using free portions of channels in a spectrum pooling system, under different SNR conditions to avoid being charged for spectrum usage.

3.2.1 Sensing Spectrum Channel with free SNR

In the first scenario the FFT Accumulation Method (FAM) is used to sense spectrum in order to develop a new strategy for recognizing channel users. Channel users are tracked according to changes in their signal parameters, for instance modulation scheme. Therefore, the primary user has a different modulation scheme with respect to secondary users, making it easy to distinguish between them if a secondary user is using a primary user's channel.

3.2.2 Sensing Spectrum Channels with low SNR

The idea behind the second scenarios to avoid interference between users under low SNR conditions. Two generated signals under low SNR by using the same (FAM) method are considered. Detection performances are then estimated and the primary user and secondary user signals are decreased by Additive Whit Gaussian Noise (AWGN) for different values of SNR.

Figure 3-1 shows different scenarios with primary users using modulation schemes Double Side Band- Amplitude Modulation (DSB-AM), Digital Video Broadcasting Terrestrial (DVB-T), and cognitive radio users using Binary-Phase Shift Keying (BPSK) and Amplitude Modulation (AM). From the diagram, it can be seen that a secondary user can use the spectrum any time when the primary user is absent from the channel by hiding them self between the primary users. Therefore, monitoring at the base station is needed to detect, real-time, any signal with different conditions using the channel.

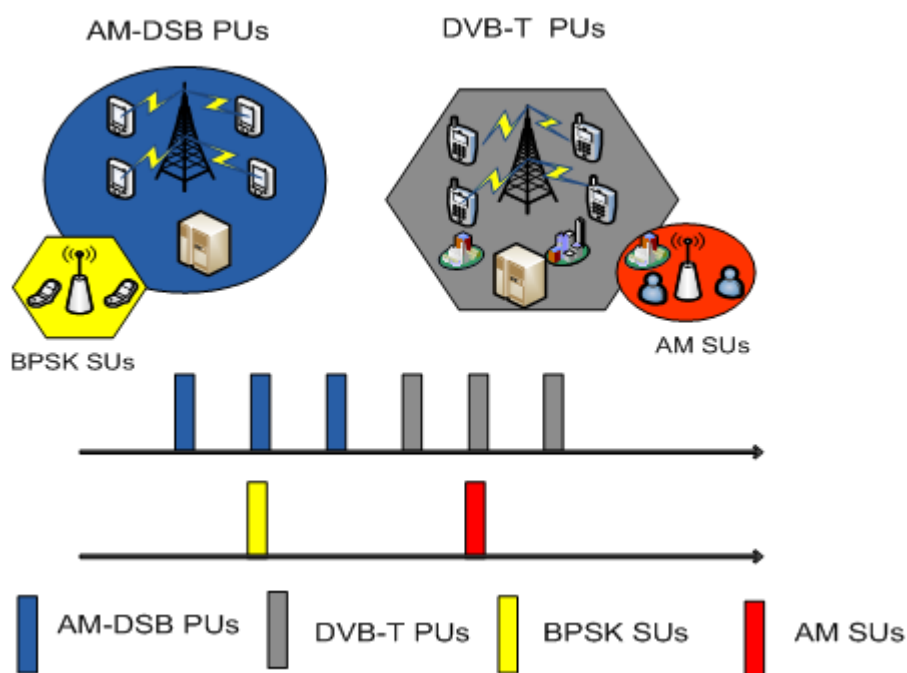

Figure 3-1: Proposal approach.

3.3 Proposal approach

The cognitive radios (CRs) are designed to work in a crowded wireless environment. Thus, inadequate spectrum may lead selfish cognitive networks to use the spectrum illegally. High reconfigurability specifications of cognitive radios make them capable to adapt their signal parameters according to their needs and the channels in which they are working. Although, CR's design have undergone considerable development, to allow these transceivers to be available in the near future, it is barely understandable how these services will be monitored.

To verify the cognitive network, a supporting sensing network is designed to survey the spectrum. Observed holes suitable to transmit are reported whenever a request to transmit and the opportunity are available. We think that duties for this sensing network should be extended to include the CR's identification. A wider network may be created by adding awareness abilities to the sensing network to create an innovative robust monitoring system. Newly designed schemes will be capable of noticing the white holes in the spectrum, and to identify each channel user. Such a development requires the amalgamation of the recommended monitoring system and information resources, for instance a Spectrum Broker. The observed data are then sent instantaneously to the decision makers to the main wireless providers for additional processing.

The possibility that a certain CR may transmit illegally falls outside the current definitions of cognitive networks. These bluffer cognitive radios can use their technical advances to adapt their carrier frequencies to transmit on a certain channel when the primary user or other rental secondary users in spectrum pooling system are switched off. However, they still need to transmit using different signal parameters to maintain broadcast dedicated to their end users. This action may occur at any time and can happen rarely or constantly. At the central station, the functionality of the primary user system must be put in place to enable what is usually termed the observe function (spectrum sensing) of the cognitive radio system. The suggested observation scheme will use the FFT Accumulation Method FAM to detect deceptive CR's behaviour instantaneously. FAM is presented as the algorithm for cyclic spectrum analysing. This method is derived from the cyclostationary

technique which is widely acceptable as the most effective sensing procedure for cognitive radios.

3.4 Detection Method in the proposed approach

The cyclostationary processing theory is proposed here as the algorithm for the developed identification scheme. Briefly this chapter explains the processes of cyclostationary, time-smoothing (FAM) method and how it was implemented. In [33] description of cyclostationary and its properties may be found.

3.4.1 Cyclostationary Processing Theory

The signal processing for cyclostationary theory, as explained by William A. Gardner [33], the cyclostationary feature, as it is reproduced in the periodicities of the second order instants of the signal, can be understood in conditions of the spectral line generation from the signal by passing the signal through a quadratic non-linear transformation. The link between the statistical property and the property of spectral line generation, known as spectral correlation, matched to the correlation that exists between the random of components of the signal, exist in distinct spectral bands. The integral of correlation can be defined as:

$$h(x) = \int_{-\infty}^{\infty} f(u) g(x + u) du \quad (3 - 1)$$

Applying an FFT, the Fourier transform pair defined by:

$$\mathfrak{F}\{h(x)\} = F(s)G^*(s) \quad (3 - 2)$$

If $f(x)$ and $g(x)$ functions in equation (3-1) are different, then $h(x)$ is called the cross-correlation functions, and if they are same it is called the autocorrelation function. The auto-correlation signal computes the predictability of the signal at time $t + \tau$ based on signal at time t [34].

Considering a time sequence of length T , the auto-correlation function will be the time average autocorrelation function given by

$$R_x(\tau) \triangleq \lim_{T \rightarrow \infty} \frac{1}{T} \int_{-\frac{T}{2}}^{\frac{T}{2}} x\left(t + \frac{\tau}{2}\right) x^*\left(t - \frac{\tau}{2}\right) dt \quad (3-3)$$

The non-zero correlation characteristic of time sequences $x(t)$ exists in the time domain, if the equation is

$$R_x^\alpha(\tau) \triangleq \left(\lim_{T \rightarrow \infty} \frac{1}{T} \int_{-\frac{T}{2}}^{\frac{T}{2}} x\left(t + \frac{\tau}{2}\right) x^*\left(t - \frac{\tau}{2}\right) e^{-j2\pi\alpha t} dt \right) \neq 0 \quad (3-4)$$

where α is the cyclic frequency and $R_x^\alpha(\tau)$ is the Cyclic Auto-Correlation function (CAF). When $\alpha = 0$ the component of equation (3-4) yields the average of time auto-correlation of equation (3-3). Therefore, the process given by (3-4) is able to extract more information from the signal than the process given by equation (3-3).

The Fourier Transformer of the auto-correlation function in equation (3-3) will obtain the Power Spectral Density (PSD) [35].

$$S_x(f) = \int_{-\infty}^{\infty} R_x(\tau) e^{-j2\pi f\tau} d\tau \quad (3-5)$$

As given in [33], the Cyclic-Spectrum Density (CSD), or the Spectral-Correlation Density (SCD) may also be achieved from the Fourier Transform of the cyclic autocorrelation function given in equation (3-4),

$$S_x^\alpha(f) \triangleq \int_{-\infty}^{\infty} R_x^\alpha(\tau) e^{-j2\pi f\tau} d\tau = \lim_{T \rightarrow \infty} \frac{1}{T} X_T\left(f + \frac{\alpha}{2}\right) X_T^*\left(f - \frac{\alpha}{2}\right) \quad (3-6)$$

where α is the cyclic frequency and;

$$X_T(f) \triangleq \int_{-\frac{T}{2}}^{\frac{T}{2}} x(u) e^{-j2\pi fu} du \quad (3-7)$$

which is the Fourier Transform of the time domain of signal $x(u)$.

The Cyclic Spectral Density (CSD) can be achieved via frequency or time smoothing models. In this chapter we propose that the time smoothing model is given by:

$$S_x^\alpha(f) \approx S_{x_{T_W}}^\alpha(t, f)_{\Delta t} = \frac{1}{\Delta t} \int_{t-\frac{\Delta t}{2}}^{t+\frac{\Delta t}{2}} S_{x_{T_W}}(u, f) du \quad (3-8)$$

where

$$S_{x_{T_W}}(u, f) = \frac{1}{T_W} X_{T_W}\left(u, f + \frac{\alpha}{2}\right) X_{T_W}^*\left(u, f - \frac{\alpha}{2}\right) \quad (3-9)$$

where Δt : time observation of the signal; and T_W : FFT window length and

$$X_{T_W}(u, f) = \int_{t-\frac{T_W}{2}}^{t+\frac{T_W}{2}} x(u) e^{-j2\pi f u} du \quad (3-10)$$

are short-time Fourier Transform sliding. Figure 3-2 shows, a portion of the signal $x(t)$, the components of frequency are calculated over a short time window T_W along the interval of time observation Δt [35]. The spectral components generated by each small time Fourier Transform have a resolution $\Delta f = 1/T_W$. Figure 3-2 shows L is the overlapping factor between each small time Fourier Transform. The value of L is given as $L \leq T_W/4$ to avoid or minimize any leakage and aliasing of cycle on the estimates [36].

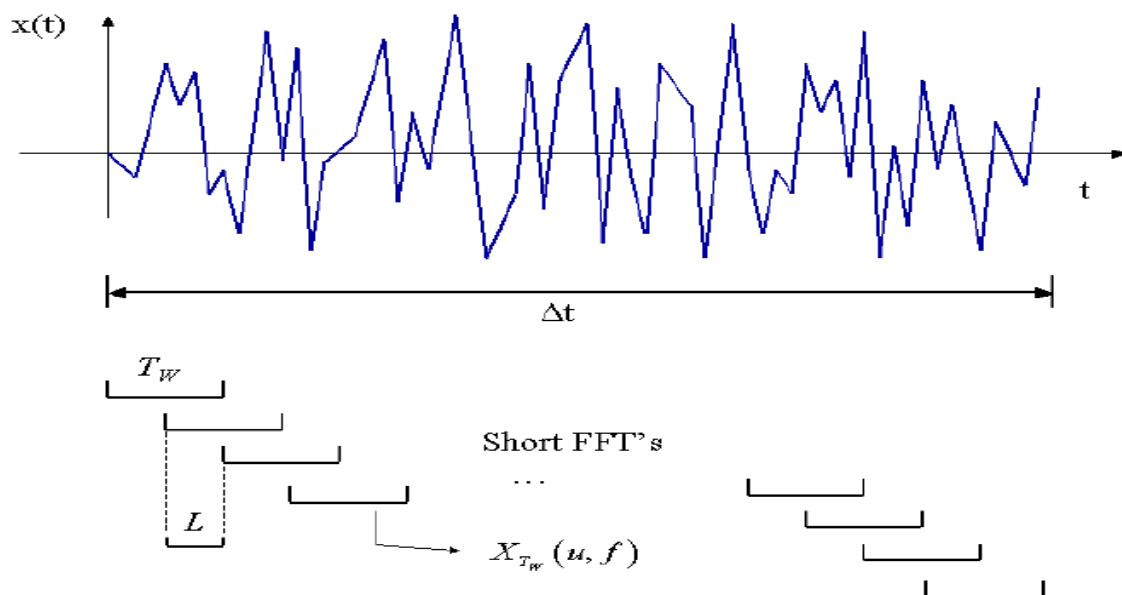

Figure 3-2: Time-Variant Spectral Period Gram [35].

Figure 3-3 shows for each small time FFT of spectral components are multiplied for the cyclic spectrum estimates, there is the same resolution ability $\Delta f = 1/T_w$. We can note that dummy u has been replaced by the time $t_1 \dots t_p$ at each small window T_w , two components separated by some α_0 and centred about some f_0 are multiplied together and the follow-on series of products then integrated over the total time (Δt), as shown in equation (3-8). The cycle frequency resolution of the estimated to the total observation time is $\Delta \alpha = 1/\Delta t$.

The spectral correlation of the cyclostationary signal gives us an enhanced off field signal detection scheme. In addition, the detection task can be achieved when searching the unique cyclic frequency (peak spectrum values) of signals with different modulations. Also, the spectral correlation density for signal detection is robust to random noise and interference.

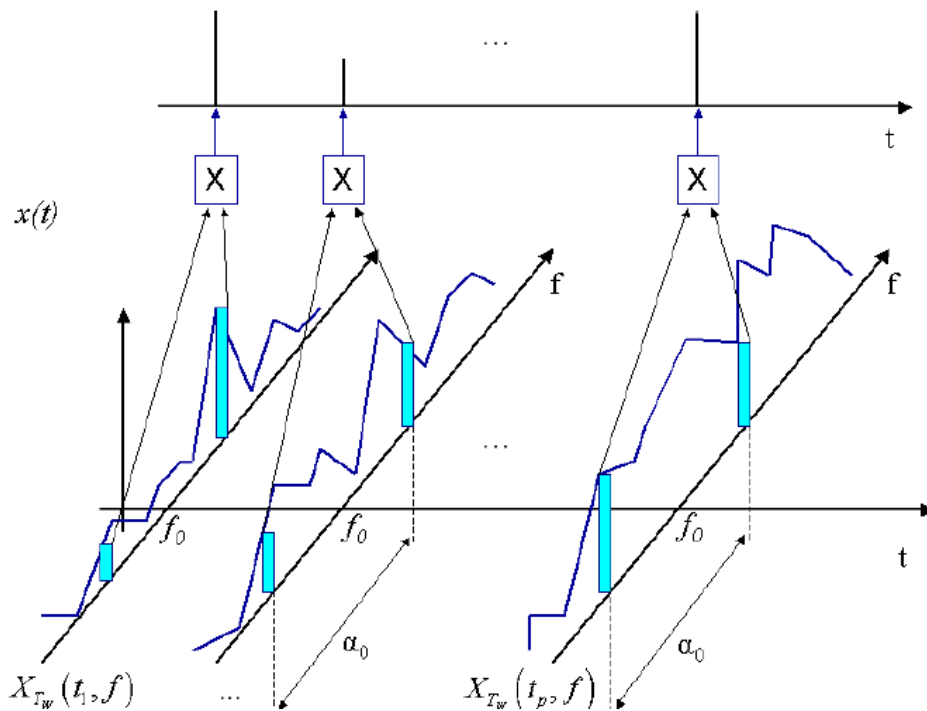

Figure 3-3: Series of Frequency Products for each small Time FFT [35].

3.4.2 Fast Fourier Transform Accumulation Method (FAM)

The idea behind developed the FFT Accumulation Method is to minimize the number of computations required to estimate the cyclic spectrum [37]. In this model the frequency

plane divides into smaller pair channel regions, using the FFT to compute the estimates a block at a time. From equations (3-8) and (3-9), the discrete term gives:

$$S_{x_{N'}}^{\gamma}(n, k)_N = \frac{1}{N} \sum_{n=0}^{N-1} \left[\frac{1}{N'} X_{N'} \left(n, k + \frac{\gamma}{2} \right) X_{N'}^* \left(n, k - \frac{\gamma}{2} \right) \right] \quad (3-11)$$

when

$$X_{N'}(n, k) \triangleq \sum_{n=0}^{N'-1} w[n] x[n] e^{\frac{-j2\pi kn}{N'}} \quad (3-12)$$

$x[n]$ is the discrete Fourier Transform, $w[n]$ is the data window (e.g. Hamming window) and the discrete equivalent of f and α are k and γ respectively. Figure 3-4 shows the block diagram used in the implementation of this method.

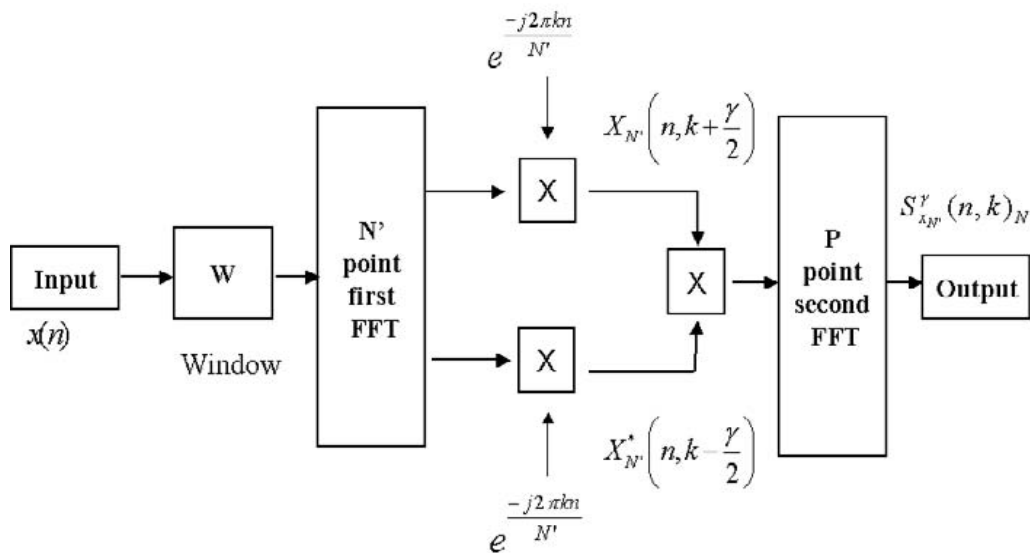

Figure 3-4: FAM block Diagram [35].

The FAM method works as follow:

- The complex demodulated values are estimated efficiently by the sliding N' point FFT, followed by a down-shift in frequency to baseband.
- In order to allow for an even more efficient estimation, the N' point FFT is hopped over the data in blocks of L samples, which means that L data points are skipped between computations of the N' point FFT.

- After the complex envelopes are computed and the product series amongst each one and the complex conjugate of the others are shaped, the time smoothing is accomplished by means of a P point FFT.

The value of L was selected to be equal to $N'/4$. The value of N' is determined according to the desired resolution in frequency (Δf) used in the algorithm, and is given by [37].

$$N' = \frac{f_s}{\Delta f} \quad (3-13)$$

The value of P is determined according to the desired resolution in cyclic frequency ($\Delta\alpha$) and is given by [37].

$$P = \frac{f_s}{L\Delta\alpha} \quad (3-14)$$

3.4.3 Procedure of Signal Detection Method

The traditional energy detection to test the observation energy levels are achieved from $S_x^\alpha(f)$ at $\alpha = 0$ for the occupied and unoccupied signal cases. However, cyclostationary detection is employed on searching the spectral unique at one of its cyclic frequencies. If the spectral unique exists at one of its cyclic frequencies (α), the signal is present, otherwise it is absent.

The procedure of detection is shown in Figure 3-5:

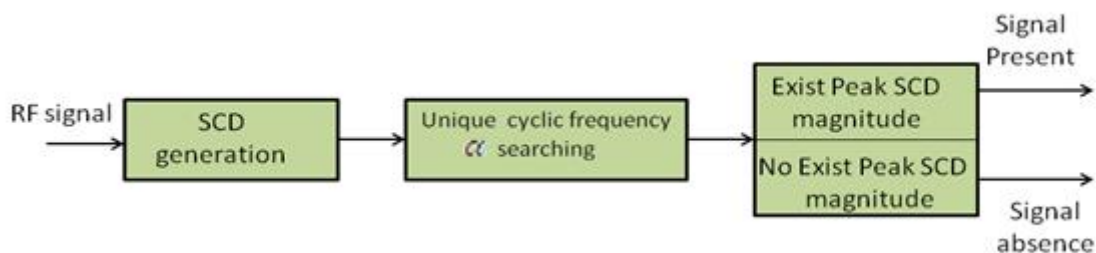

Figure 3-5: Detection Procedure.

3.5 Comparative performance analysis of the proposed approach

In order to show a general idea of how the results of the FAM method should look in both scenarios (free SNR and low SNR in channel detection), we will briefly provide the choice of MATLAB[®] testing signals and signal fields in both scenarios with $f_s = 800 \text{ MHz}$, $N' = 32$, $P = 8$ and $L = 4$.

1. Double Side Band-Amplitude Modulation (DSB-AM)

In order to show the results clearly and to implement the idea, different modulation signals were selected. Therefore, the Double Side Band-Amplitude Modulation (DSB-AM) signal is selected as an analog-modulated signal. This signal has been chosen for first scenario (one channel detection).

For the AM-DSB signal the characteristic parameters used are the value of sampling frequency equal to 800 MHz and zero signal-to-noise, SNR.

2. Binary-Phase Shift Keying (BPSK) signal

The second signal we used in single channel detection was Binary-Phase Shift Keying (BPSK). This digital signal was chosen to simulate in MATLAB[®] in order to show our idea clearly, because using different modulations obtains different shapes using the cyclostationary FAM method in single channel detection as will be seen in the simulation results.

For the BPSK signal, the characteristic parameters used are the same as in the DSB-AM without SNR case, namely 800 MHz value for simulation frequency sampling.

3. Digital Video Broadcasting Terrestrial (DVB-T) (OFDM Signal Modulation)

In the second scenario the cyclic spectrum estimation is based on the cyclostationary method to detect the presence or absence of the primary signal. The OFDM signal of Digital Video Broadcasting Terrestrial (DVB-T) with the following parameters 4-QAM modulation, 2.016 carrier frequency, 806.4MHz sampling frequency , 224 μ s OFDM symbol period, 1705 subcarriers, 446.4 MHz Carrier separation and AWGN channel with different values of SNR is considered for the cyclic spectrum estimation and detection.

4. Amplitude Modulation (AM) Wireless Microphone signal

For the second scenario we used an AM signal for a wireless microphone secondary user with 0.2 MHz signal bandwidth in an AWGN channel under different values of SNR.

3.6 Simulation Scenarios and Results

In order to evaluate the proposed method for efficient detection at real time and identify primary and secondary users at the base station, two scenarios are proposed to detect and identify secondary and primary users. The scenarios are as follows:

1. Detection and identification primary and secondary users on one channel band:

MATLAB[®] simulation code was created to generate FAM as the sensing mode for our model. Two signals were fed into the code as the primary and secondary users. The primary user or rental secondary user in spectrum pooling system is suggested to have an analogue signal of Amplitude Modulation-Double Side Band AM-DSB, and the secondary user is suggested to be a digital Binary Phase Shift Keying BPSK signal. The simulation was run at a frequency of 8MHz.

Figure 3-6 shows the spectral correlation function for the AM signal. The modulation used here is Double Side-Band AM signal. It is easy to detect the modulation scheme from the signal's profile.

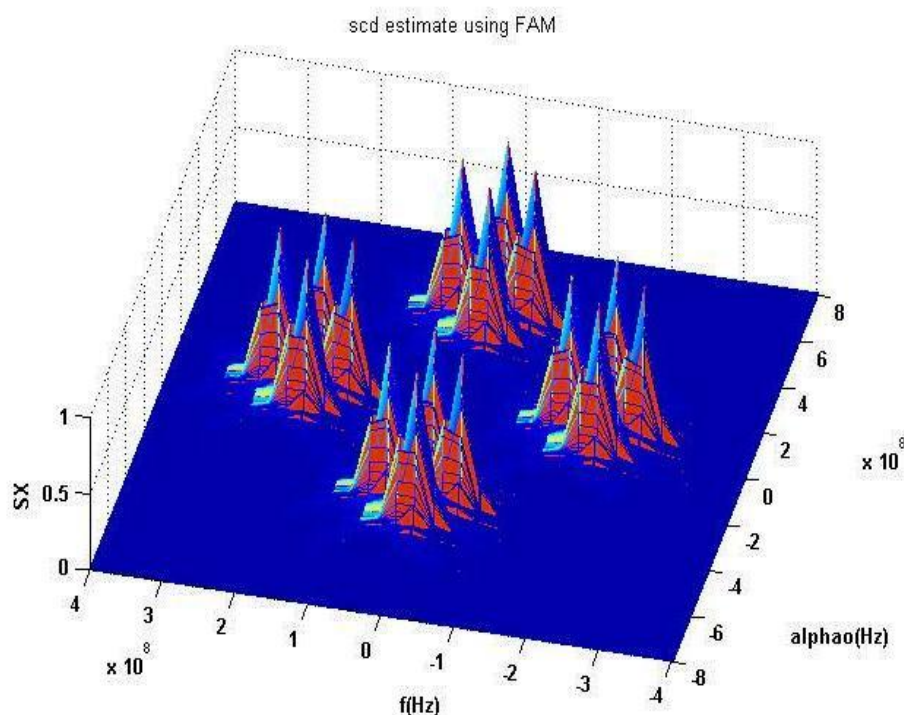

Figure 3-6: Cyclic Spectrum of the DSB-AM-DSB.

The DSB-AM signal can also be re-obtained in an additional elevation sight to assure that the modulation scheme is correctly determined. Figure 3-7 shows an overview for the received primary signal.

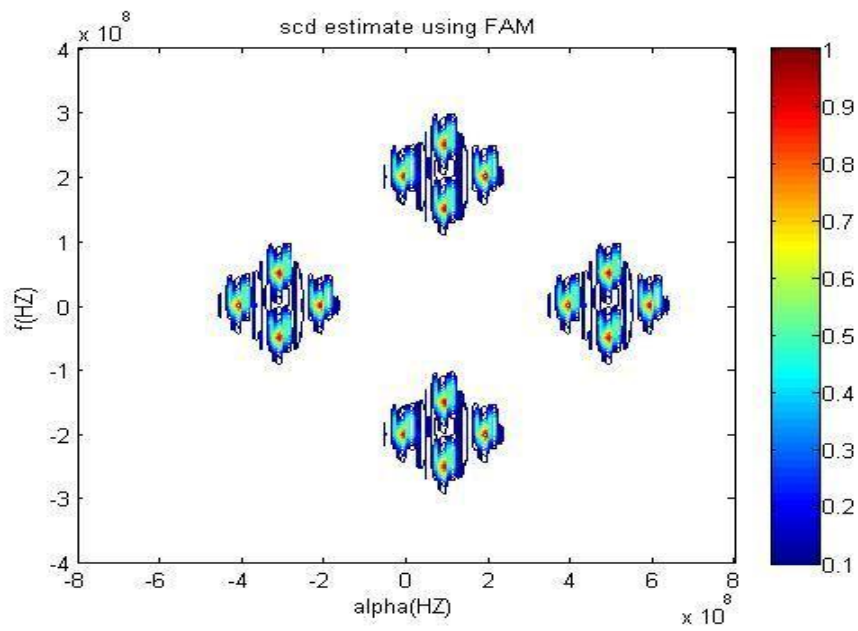

Figure 3-7: Contour Figure of the DSB-AM Signal.

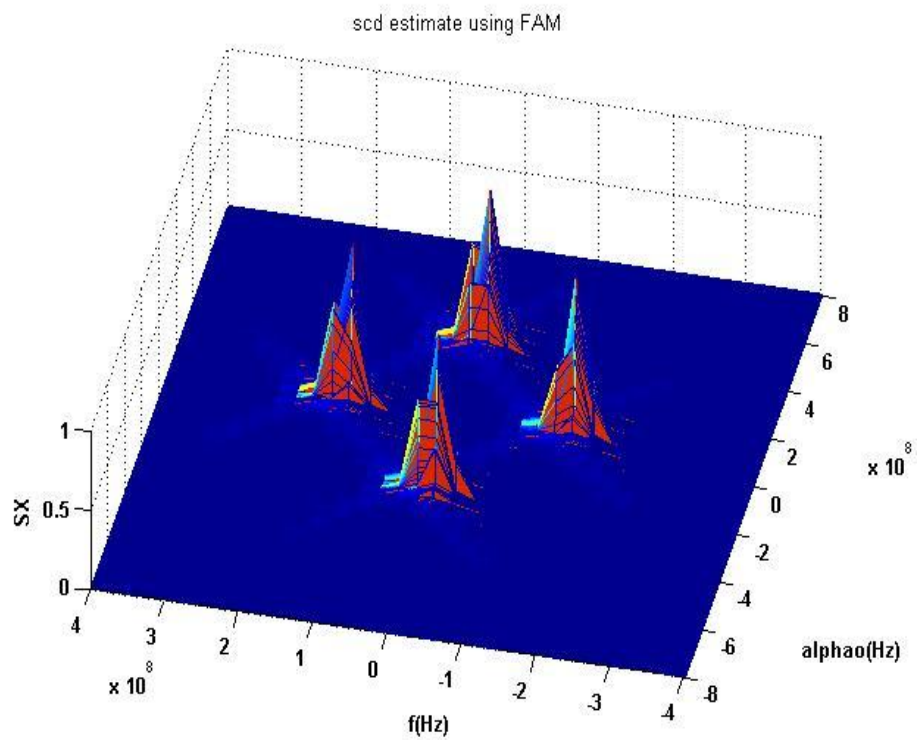

Figure 3-8: Cyclic Spectrum of the BPSK.

Subsequently, we examined the secondary user signal using the same technique. Assuming that the CR transmitted signal is BPSK, the detected waveform is shown in Figure 3-8.

It is important to look at the received signals from different sides. This will avoid any ambiguity in the signals modulation / source category. Hence, the other outlook for the secondary user spectral function is show in Figure 3-9.

The differences between the primary or rental secondary user in the spectrum pooling system and secondary simulation signals using the FFT accumulation method are substantial. These results make this method a preferred choice for this category of signal discovery. Additionally, cyclic spectrum enables accurate examination for changes in the signal's periodicity. Thus, minor fluctuations resulting from wireless environmental changes and interference can be estimated, compared and identified.

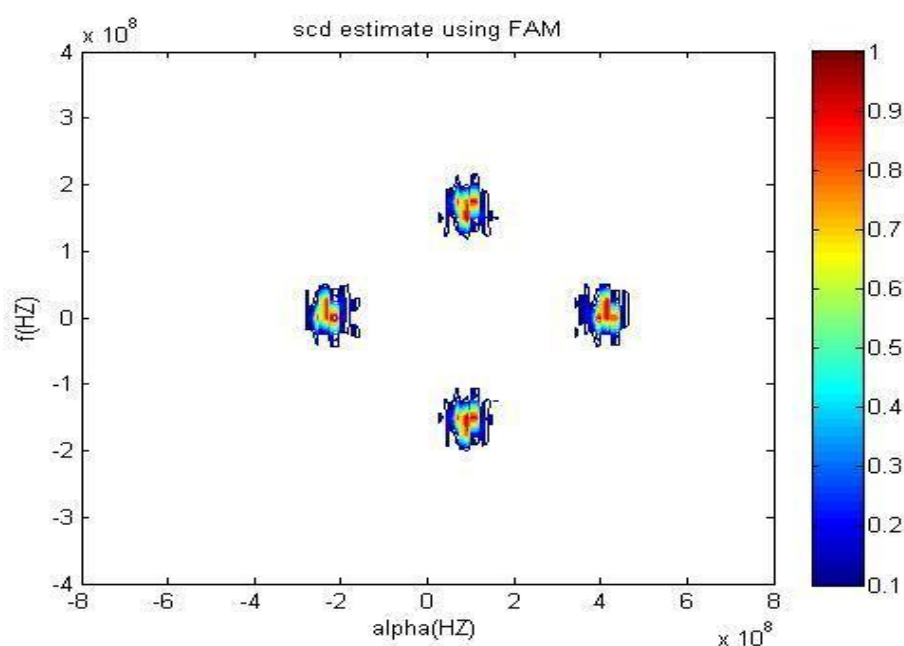

Figure 3-9: Contour Figure of the BPSK Signal.

The obtained results show that the FAM correlation function detected signals in the time domain are transferred to the frequency domain. Subsequently, other estimations are implemented to determine each signal type. Although this will ensure the accuracy of obtained results, the effects of the time spent in this process are unknown with regard to

the detection speed. Reasonably, α changes speed affects on CAF and CS will be the critical factor on the results of reliability and visibility. The simulation was performed assuming perfect transmission conditions without any consideration for environmental and systematic noise.

2. Signal Detection based on Cyclic Spectrum of Undefined Secondary user with different SNR in Cognitive Radio System:

In the second scenario, the fundamental of CR is spectrum sensing, which is a function to detect the existing spectrum location and to find the empty frequency bands that may be reused by secondary users. Additionally, our strategy implements spectrum sensing on the channel bands to detect the signal and identify whether it is a primary or secondary signal more efficiently.

In our study, there are two kinds of signal for the primary user, DVB-T, signal and hiding secondary user, AM microphone signal in AWGN channel under different values of SNR. In order to detect the CR user behaviour instantaneously and distinguish between the primary user in low SNR, as in the first scenario, we use the FAM technique.

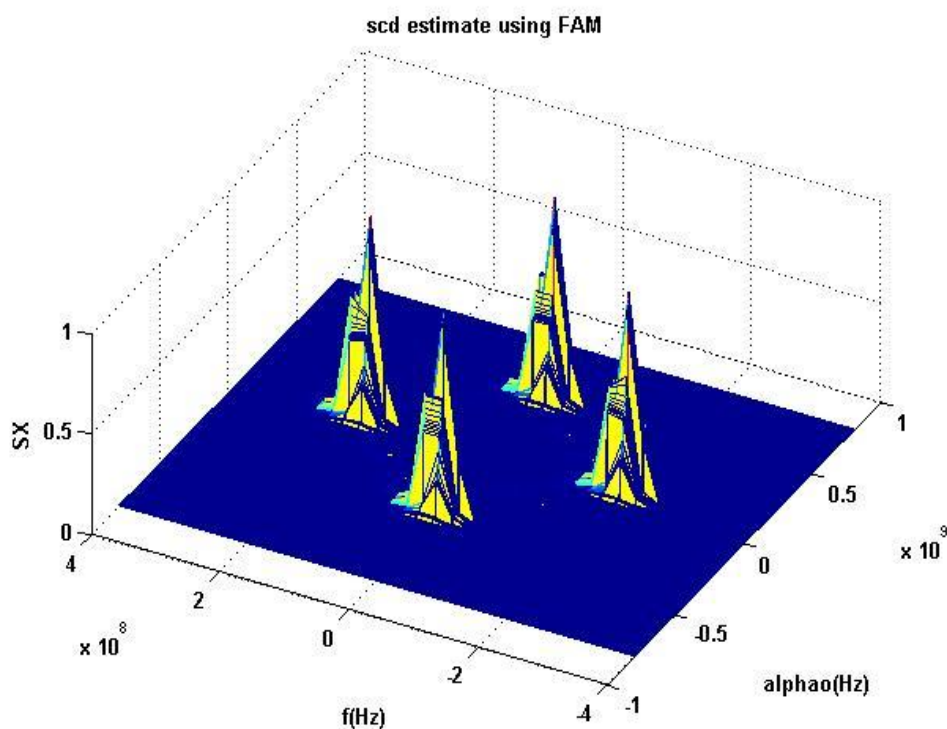

Figure 3-10: Cyclic Spectrum of the DVB-T signal with free noise.

For comparison, MATLAB[®] code was created to generate the FAM method as a sensing mode for our model and two signals with different values of SNR were fed into the code as primary and secondary users.

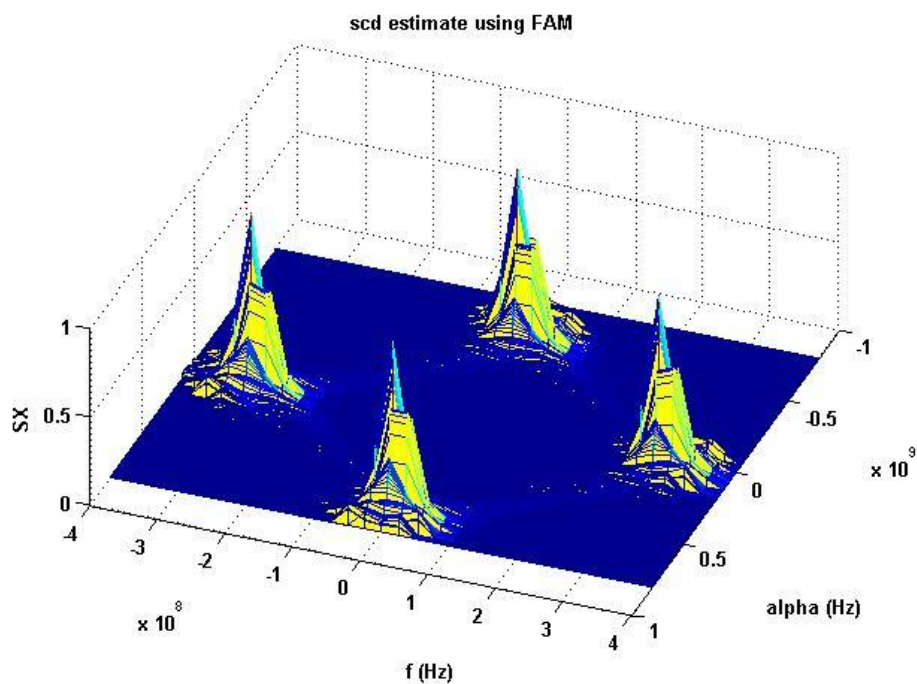

Figure 3-11: Cyclic Spectrum of the AM signal with free noise.

Figure 3-10 and Figure 3-11 shows the spectral correlation function for DVB-T primary user signal and AM secondary user signal with noise free respectively. The diagrams show the peak values of the unique cyclic frequency. Figure 3-12 shows the counter figure of signal DVB-T in a noise free environment, and Figure 3-13 shows a contour of the AM signal in a noise free environment.

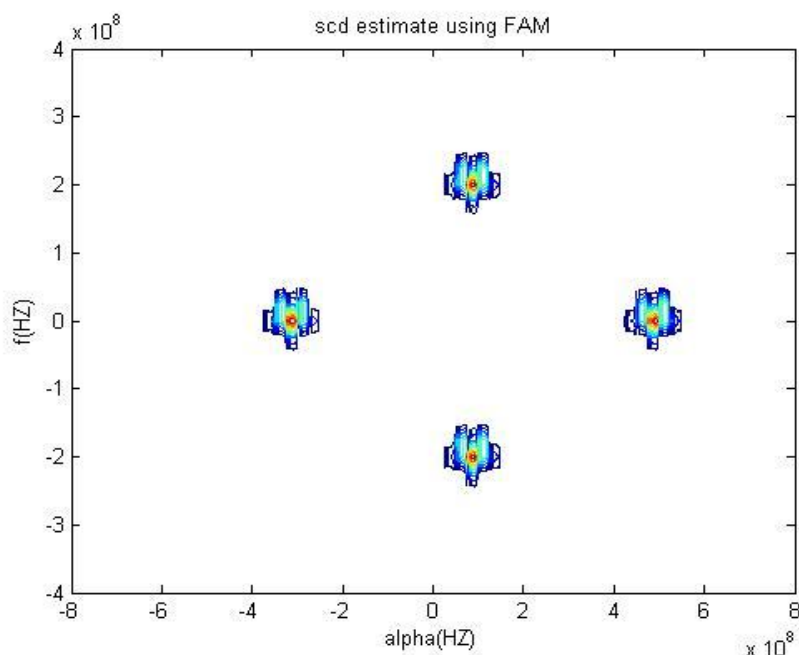

Figure 3-12: Contour Figure of the DVB-T Signal.

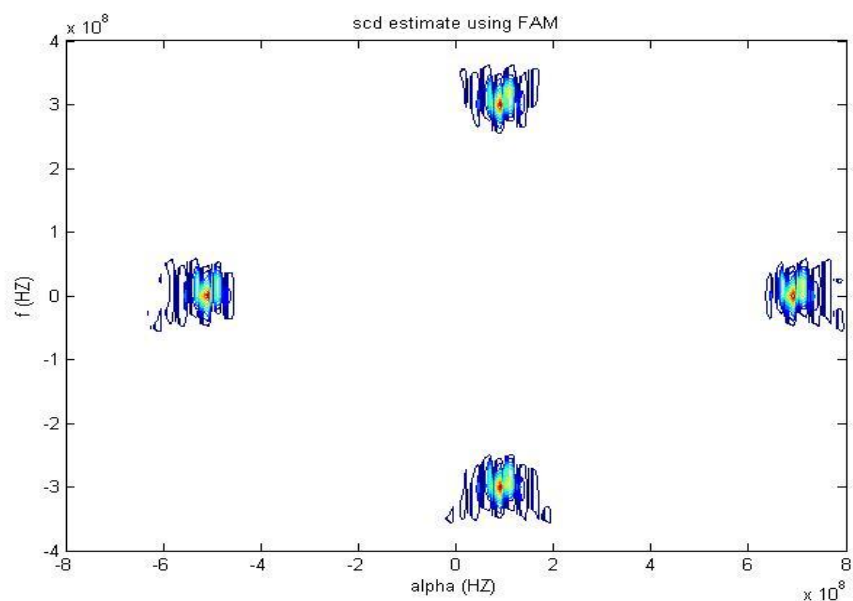

Figure 3-13: Contour Figure of the AM Signal.

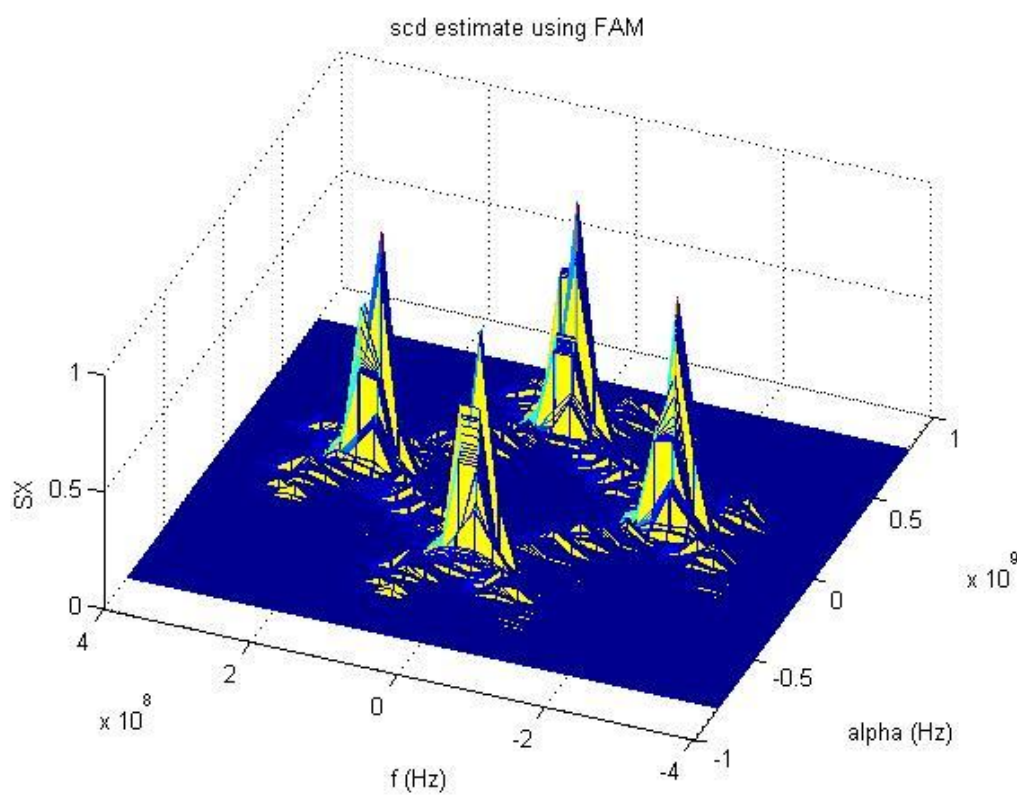

Figure 3-14: Cyclic Spectrum of the DVB-T Signal with SNR= 5.

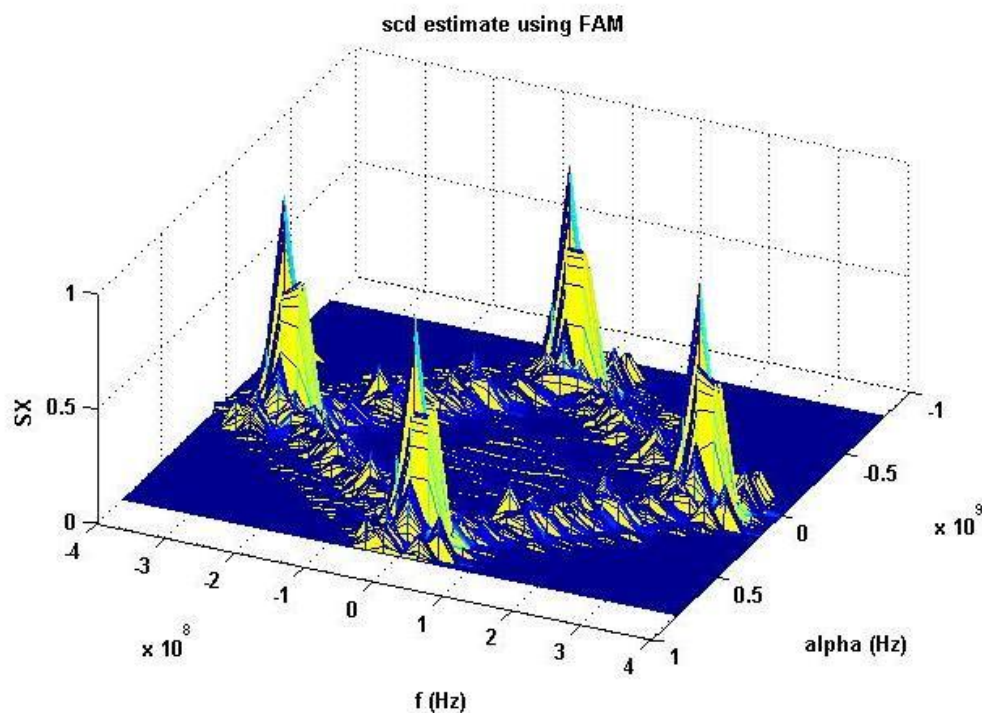

Figure 3-15: Cyclic Spectrum of the AM Signal with SNR= 5.

The following diagrams show the simulation performance of the DVB-T primary signal and the AM secondary signal, which are corrupted by an AWGN channel with different level of SNR, using the FAM scheme.

The cyclic spectrum of DVB-T and AM signals are shown in Figures 3-14 and 3-15 for an SNR equal to 5dB, the peak value of the primary and secondary users in the unique cyclic frequencies can be clearly seen. Figures 3-16 and 3-17 show the contour figures of the DVB-T and AM signals under SNR=5dB. Four clear points of the signals are seen, the unique frequency of the signals are denoted by the intersection point.

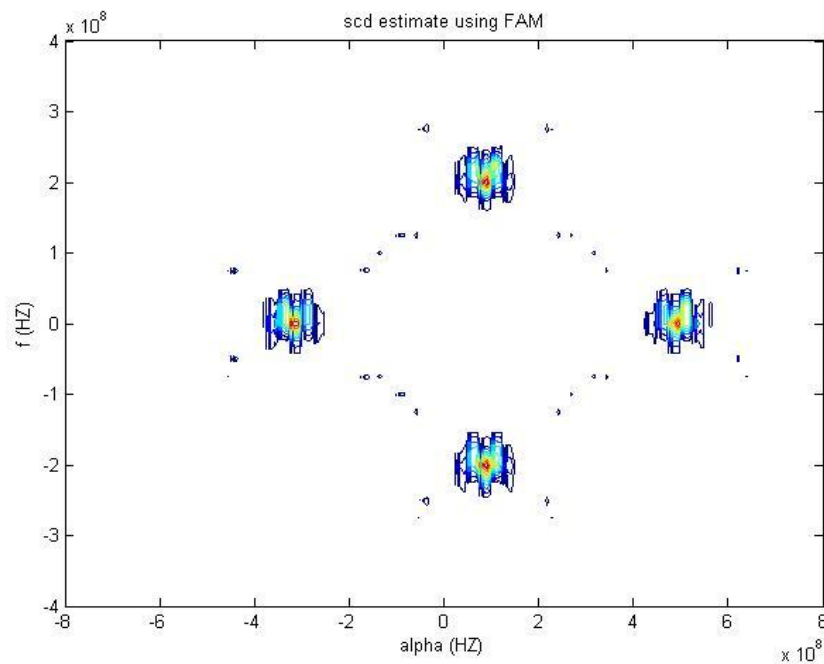

Figure 3-16: Contour Figure of the DVB-T Signal with SNR= 5.

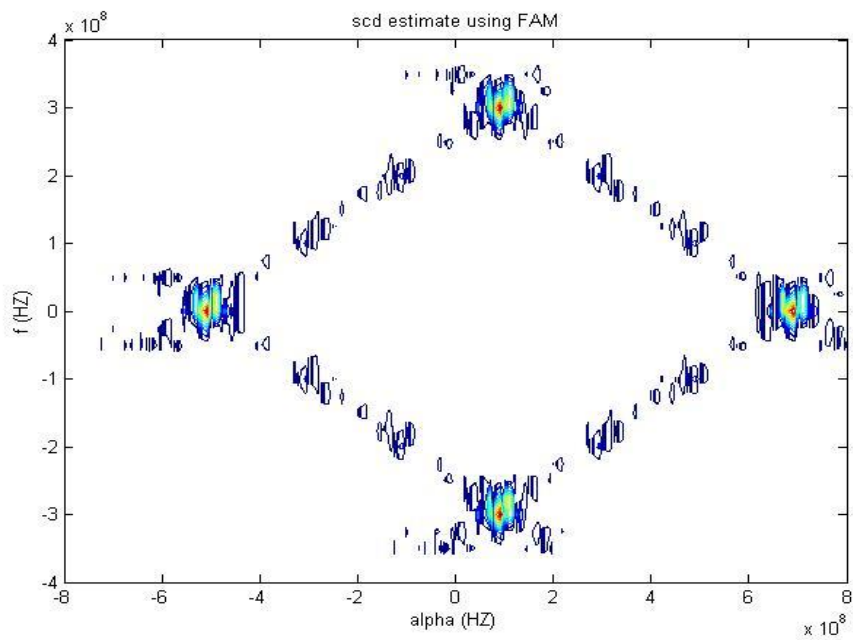

Figure 3-17: Contour Figure of the AM modulation signal with SNR= 5.

At lower SNR levels, e.g., 0 dB, the spectral correlation peaks are more corrupted by noise, but the signal peak values can obviously be seen, see Figures (3-18 and 3-19).

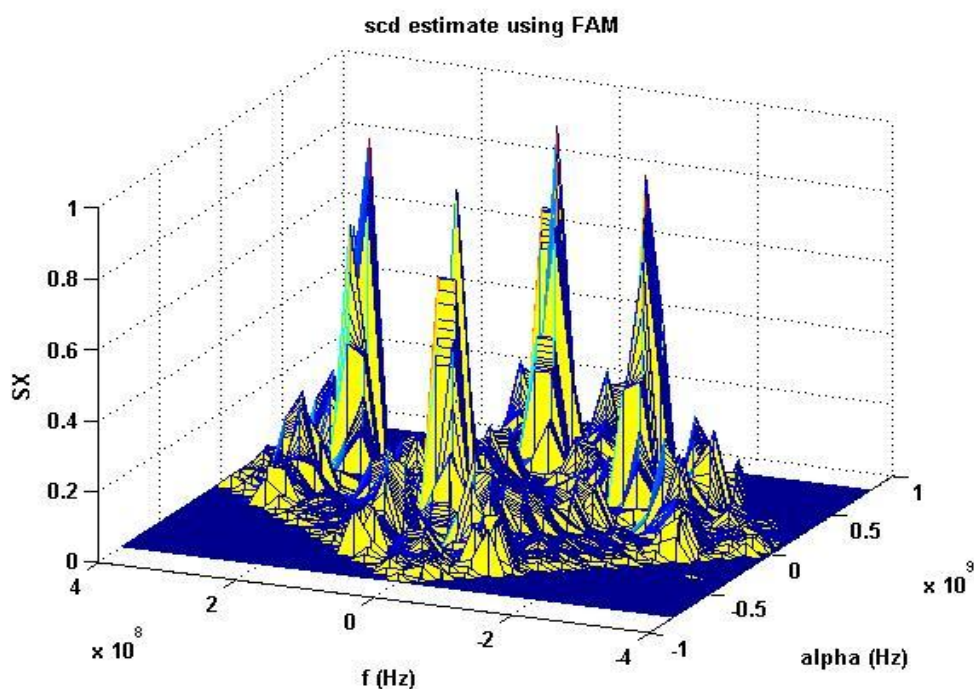

Figure 3-18: Cyclic Spectrum of the DVB-T Signal with SNR= 0.

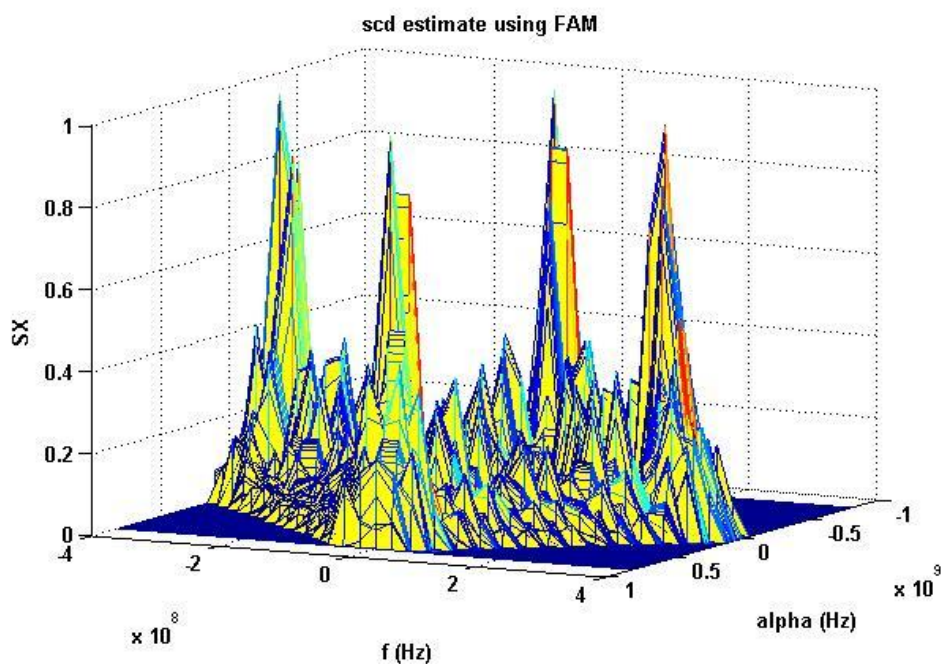

Figure 3-19: Cyclic Spectrum of the AM Modulation Signal with SNR= 0.

Figures (3-20 and 3-21) show that the background area is affected by noise. With increasing levels of SNR, the background areas get darker and there is lower visibility of the intersection points, which are mixed with noise points.

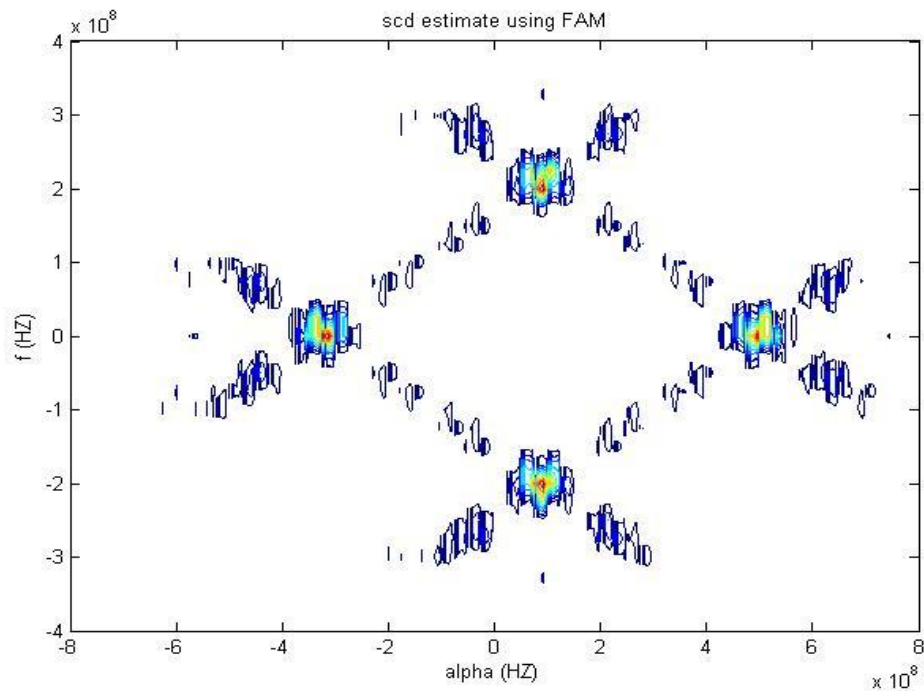

Figure 3-20: Contour Figure of the DVB-T Modulation Signal with SNR= 0.

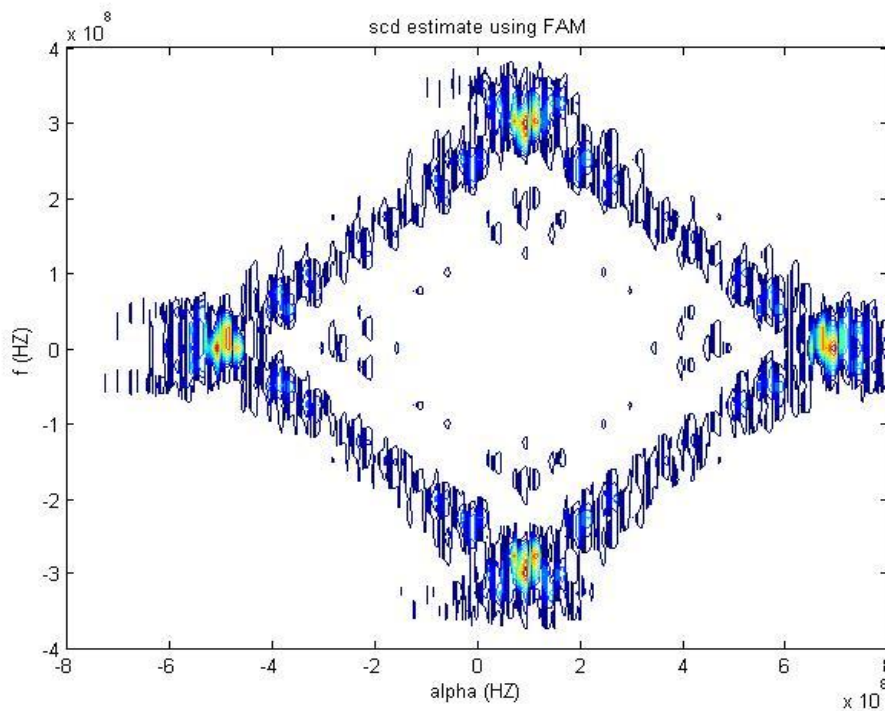

Figure 3-21: Contour Figure of the AM Modulation Signal with SNR= 0.

In Figures (3-22 and 3-23), taking a very low level of SNR of -10dB, the peaks of spectral correlation are overwhelmed by the noise and spatially with the secondary user

(AM). The signals may be easily distinguished (primary and secondary on the same channel) with this low SNR. Therefore, the interference can be estimated, compared and identified under any changing transition conditions.

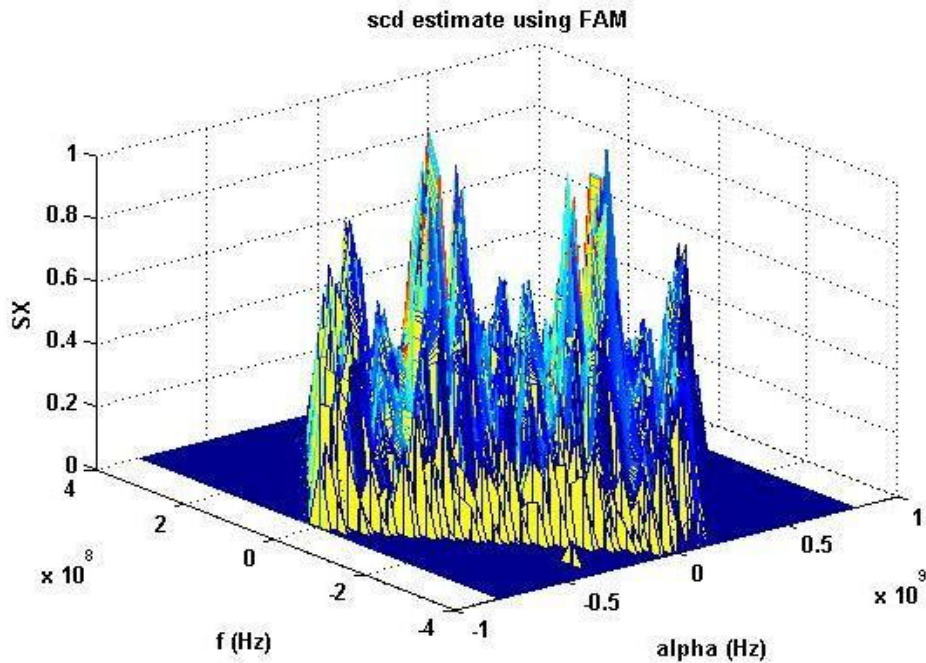

Figure 3-22: Cyclic Spectrum of the DVB-T Signal with SNR= -10.

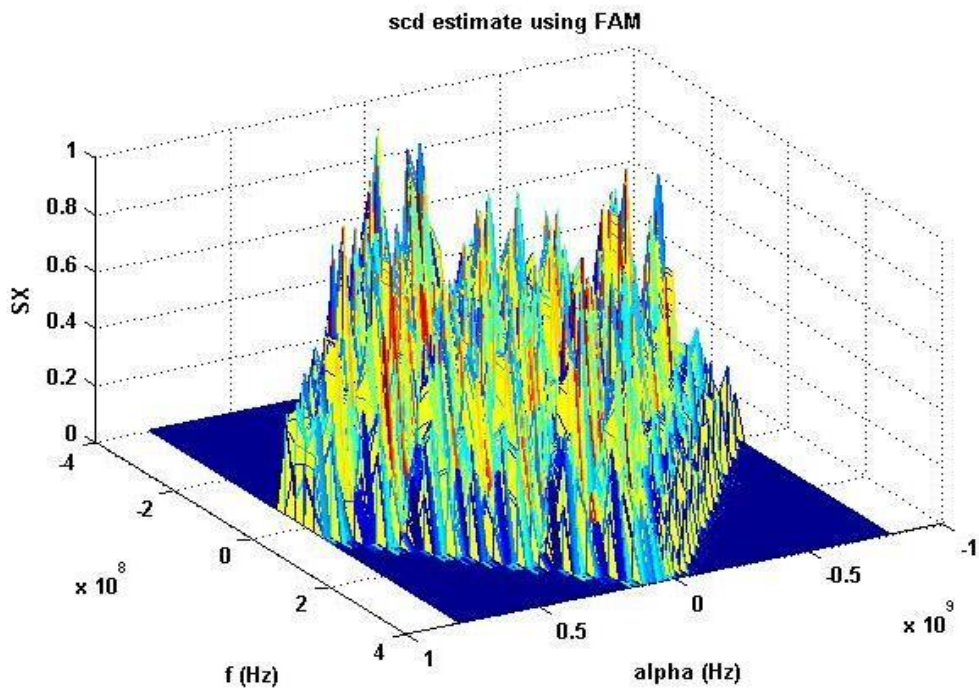

Figure 3-23: Cyclic Spectrum of the AM signal with SNR= -10

The idea behind the contour figures of the spectral correlation density of the DVB-T and AM modulation signals makes the background of the foursquare band observable. The noise effect is greater when the SNR level increases, therefore the white foursquare band gets darker and worsens the visibility. This is supported by Figures (3-24 and 3-25) as shown below.

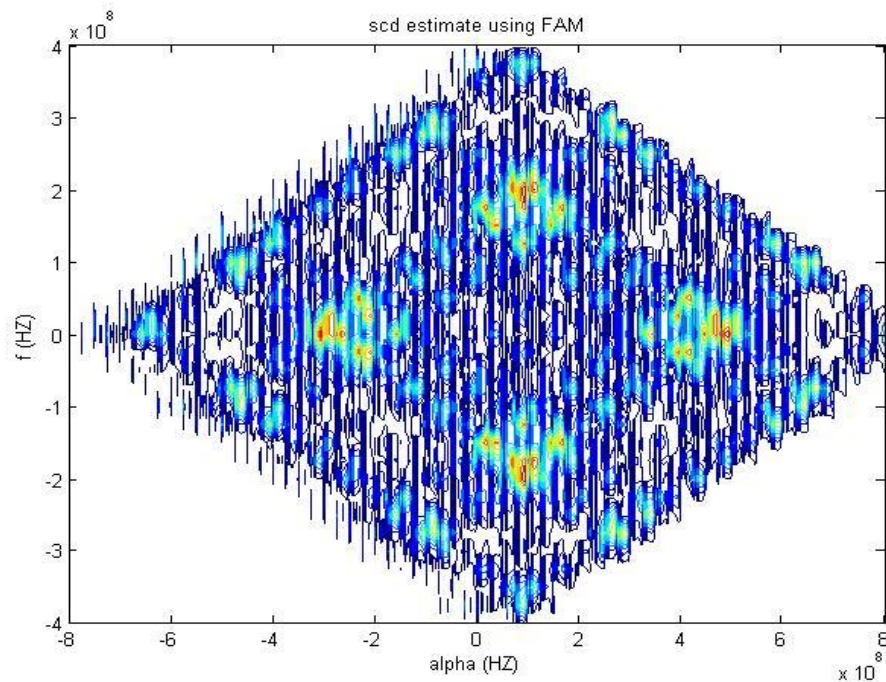

Figure 3-24: Contour Figure of the DVB-T Modulation Signal with SNR= -10.

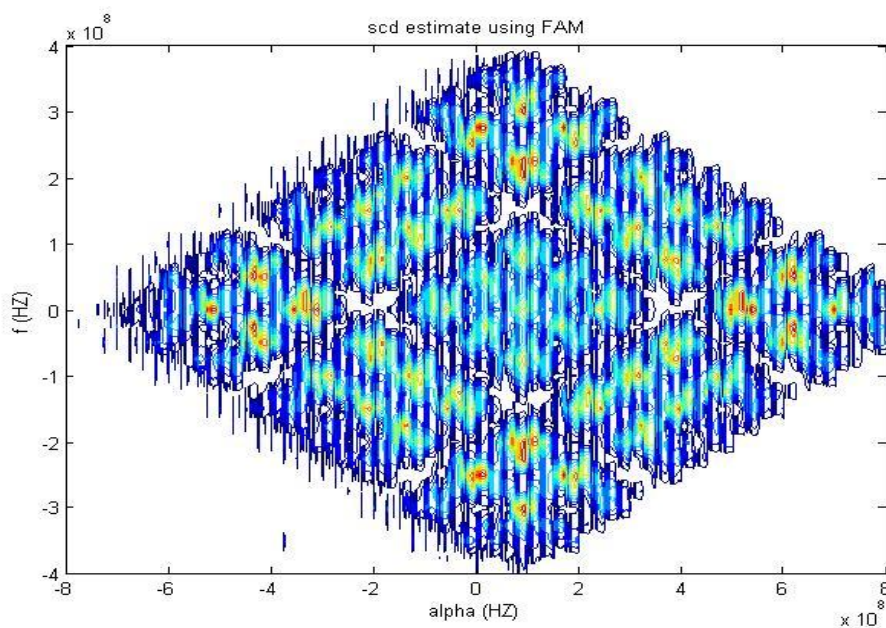

Figure 3-25: Contour Figure of the AM Modulation Signal with SNR= -10.

On the other hand, the spectral correlation points for the DVB-T signal have improved visibility than the AM modulation signal shown in the contour diagrams.

We find that the signals in the unique cyclic frequency and cyclic point in the contour diagrams are easier to detect using the FAM method, spectral correlation based peak detection at low SNR. Additionally, from analysis of the different figures shows clearly the cyclic spectrum estimation based detection, and identification for DVB-T signal is better than for the AM case.

The distinctions between the primary licence user and hiding secondary user are substantially noticeable in the wireless network system with simulated signals using the FFT accumulation technique. This result makes this method a preferable choice for this category of signal detection. The estimations from using FAM for detecting signals under noise condition are implemented to define each signal to avoid any interference (between users channel band), detect and identify hiding users (which is avoided by using spectrum charging) and for efficient Dynamic Spectrum Allocation.

3.7 Summary

This chapter has given a detailed explanation of detecting hidden secondary users using the cyclostationary FAM model in one channel spectrum band under low SNR conditions. This model works as a monitoring system in the cognitive radio application-based cyclostationary detection FAM model, which is sensing spectrum to detect both primary and secondary users. The model aims to detect any anonymous user using spectrum without paying for it, efficient spectrum allocation and avoiding interference between users. The cyclostationary FFT Accumulation method is used as spectrum sensing technique for cognitive radio application, because with this technique distinctions between signals can be made by showing different CSD for each signal. Simulation results for the cyclostationary FAM model makes this method a preferred choice for this type of signal detection.

The proposed model shows a novel improvement; as far as we are aware, , no other efforts have been made to use the FAM to make a distinction between channel signals, as described here. We argue that a monitoring system can be developed using FAM and enhanced by self-learning to recognize any CR prohibited translation and deal with it at once. The learning features will allow the anticipated system to be more efficient when introducing a variety of signals.

CHAPTER 4

Performance of Spectrum Sensing Methods for UWB-CR System

4.1 Introduction

Developments in software radio are ongoing since the cognitive radio defined by [38] has been shown to be the best solution for the forthcoming spectrum congestion. Traditionally, the use of radio frequency bands has been regulated in most countries through the process of spectrum allocation in which the use of a particular frequency band is restricted to the licence holders of the band. Within this framework, spectrum has often been viewed as a scarce resource in high demand. However, measurements have suggested that most licensed spectrum is often under-utilized with large spectral holes at different places at different times [39].

Recently, wireless applications are increasing, and the short supply of radio spectrum and the coexistence of different kinds of wireless communications is one of the main issues to be solved [40],[41]. Moreover, unlicensed bands are using completely, and the licensing spectrum is difficult to access and use, for example, Wireless Local Area Network (WLAN) experiences limited frequency spectrum, and the ultra wideband (UWB) system, a new wireless standards application for a wireless personal area network (WPAN) could increase the current data rates, experiences limited transition power .

According to the FCC regulation [42], UWB is a future technology for short and medium range wireless communication networks, with different revenue choices for high data rates. Furthermore, UWB is an underlay system, because it can co-exist with licensed and unlicensed users in the same spectral domains. On the other hand, UWB also has tempting features such as the flexibility of adapting data rate, bandwidth, transmit power

and pulse shape. Additionally, UWB has reduced complexity because it has low power consumption, and will therefore lead to a limited system cost. UWB usually has two proposed implementation methods. These technologies are orthogonal frequency division multiplexing based UWB (UWB-OFDM) and the impulse radio based UWB (IR-UWB) [43].

The opportunistic use of spectrum can be a component of the ultra wideband and cognitive radio system. In a ultra wideband system, the signal power is spread over a large bandwidth. As it shares radio spectrum with other systems, UWB can cause them harmful interference. In this condition, detecting the presence of the primary users becomes essential for the coexistence of UWB devices with any present users residing within the UWB frequency band. Therefore, combining the UWB and Cognitive radio technologies seems to be a promising solution for the future. Particularly with cognitive radio capabilities, such as sensing the spectrum reliably to ensure whether it is being used by licensed users, UWB radios can adjust the radio parameters to exploit the unused parts of the spectrum. Recent research has focused on the study of UWB coexistence , assuming that such systems will be activated in an environment characterized by the existence of heterogeneous interfering users., The essential combination of ultra wideband-based cognitive radio (UWB-CR) with spectrum sensing to detect licence spectrum under different fading environments. UWB spectrum does not require a cognitive radio setup according to FCC power levels , but in higher power levels that are required for cognitive radio.

In this chapter we will focus on implementation of the spectrum sensing in UWB-CR and evaluate various detection methods for detecting primary user signals, in different fading scenarios as figure 4-1 shows. The comparison and investigation number of detection methods under different fading channels is considered. Investigation of a number of detection methods and their comparison under different fading channels is considered.

4.2 Ultra Wideband System

The opportunistic spectrum sharing in unlicensed frequency bands of cognitive radio can be linked with ultra wideband technologies. Here we present a brief background of UWB technology and some ideas behind its use for cognitive radio for its [41]:

- It is the physical layer of a wireless personal area network.

- It facilitates high data rate and low transmission energy.
- It has been developed for radar.
- Now, it is being used in a wide variety of applications, monitoring and multimedia services.
- It utilizes and shares radio spectrum efficiently similar to CR.
- It operates in unlicensed bands, similar to CR.
- It operates between 3.1 GHz and 10 GHz.

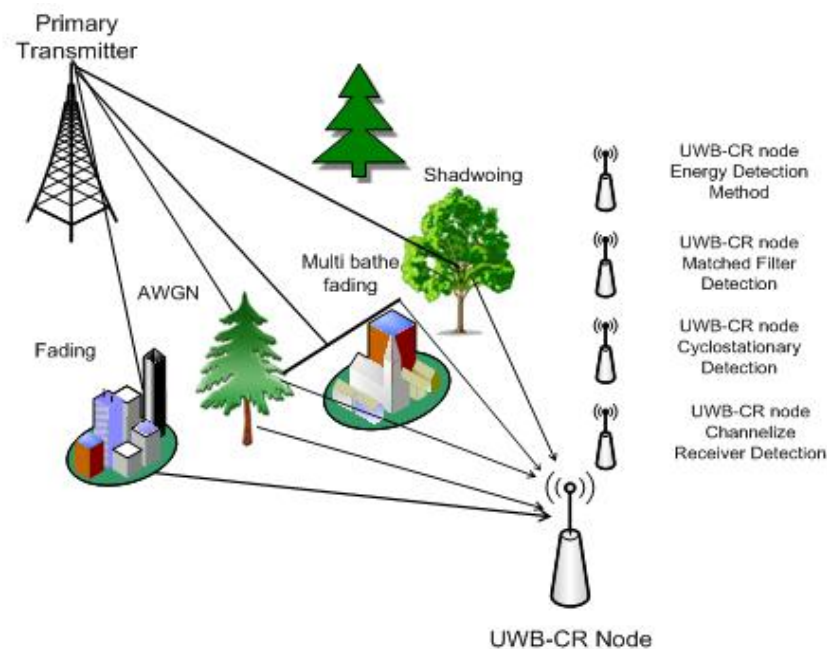

Figure 4-1: Model of Implementation different Spectrum Sensing Methods with different fading Channels.

The designation of the UWB signal present, whether if a bandwidth is more than 500 MHz or fraction bandwidth B_f is larger than 20%. Fractional bandwidth is given by [44];

$$B_f = 2 \frac{f_h - f_1}{f_h + f_1} \quad (4 - 1)$$

Where f_1 and f_h are lower and higher frequencies respectively, measured at -10 dB, over which the UWB impulse signal is unaffected. The UWB signal is given by

$$s(t) = \sum_{k=-\infty}^{\infty} A_k * w(t - kT_s - B_k\Delta) \quad (4 - 2)$$

where A_k and B_k are modulation type (± 1), $w(t)$ is the waveform of the fundamental signal, the symbol duration is T_s and the offset of pulse position is Δ .

For $w(t)$, the second derivative of a Gaussian impulse is given by;

$$w(t) = \left[1 - 4\pi \left(\frac{t}{\tau_m} \right)^2 \right] \exp \left[-2\pi \left(\frac{t}{\tau_m} \right)^2 \right] \quad (4 - 3)$$

where τ_m is the width parameter and $t_o < t < t_o + T_s$ is about 0.4 times the pulse width T_w . For example, a Pulse Position Modulation (PPM) signal is formed applying $A_k = 1$ and $B_k = \pm 1$ as input data. A Biorthogonal Pulse Position Modulation (BPPM) signal is shaped using $A_k = \pm 1$ and $B_k = \pm 1$.

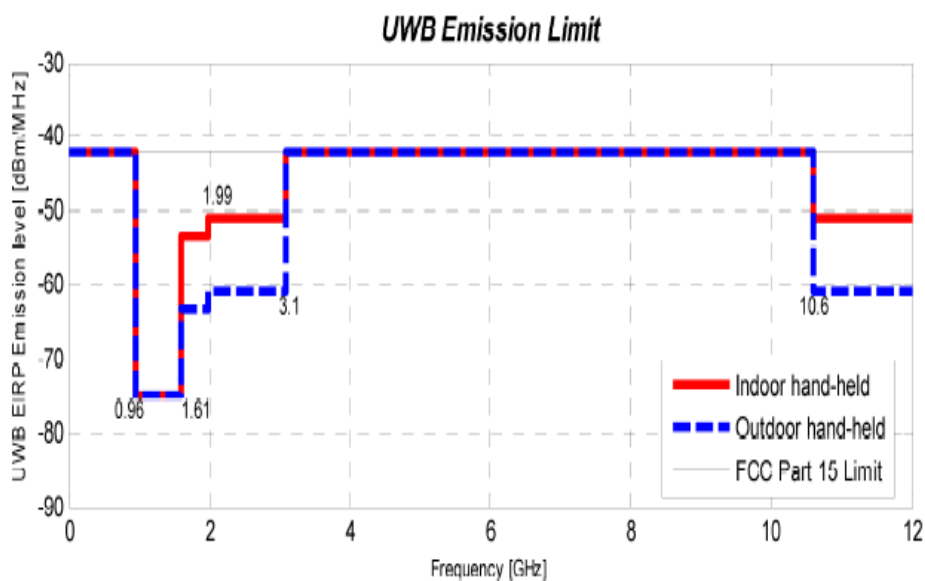

Figure 4-2: Demonstrates the Presenting FCC limits of different UWB Applications [38].

Regardless of the similarity with spectrum sharing, there are some differences between UWB technology and CR technology. At a given time and location, a CR utilizes unused spectrum and spectrum holes, while the UWB signal spectrum may overlap with the PU signal spectrum. Additionally, the CR technology may use upper transition power and

may be arranged for longer range communication, where the UWB is primarily short range communication due to transmission power limitations [4]. Therefore, UWB and CR may use different frequent bands. Figure 4-2, demonstrates the present FCC limits for different UWB applications.

In order for the UWB system to have the capability to detect and reuse unused portion of spectrum, the UWB-CR system needs to sense the radio spectrum under different channel conditions to use optimally unoccupied spectrum without causing harmful interference to different users.

4.3 Cognitive Radio Requirements with UWB system Feature

One of the primary goals targeted for cognitive radio is to exploit the existing radio resources efficiently. To guarantee the best spectrum utilization, cognitive radio needs to satisfy several requirements [45].

The main cognitive radio requirements include:

- i. Insignificant interference to licensed systems and the ability to avoid interference.
- ii. Ability to adapt itself to different radio link qualities.
- iii. Capability to sense and determine critical parameters about the channel, environment, location, using the received signal.
- iv. Ability to utilize the diversity of spectral opportunity linked to adaptation of bandwidth.
- v. Adaptable data rate, flexible pulse shape and bandwidth, information security, transmit power, and limited cost.

It can be seen that there is a good match between the requirements of cognitive radio and what UWB offers.

The main features of UWB signal are explained in terms of satisfying the requirements of cognitive radio.

4.3.1 Decreased Interference to Licensed Users

One of the most significant issues of cognitive radio is that the interference caused by secondary users' devices to licensed users remains at an insignificant level.

UWB system can utilize various narrowband interference avoidance methods, such as pulse shaping, antenna design and time hopping code adjustment to desist interfering with licensed users.

4.3.2 Dynamic Spectrum

One of the key features of cognitive radio is that the targeted frequency spectrum is sensed periodically in order to ensure its availability for opportunistic usage.

Flexible spectrum shaping is a part of the UWB system. UWB communication is essentially realized via the transmission of short pulses, changing the duration or the form of the pulses directly adjusts the occupied spectrum. Various pulse shaping options in a UWB transmitter can select one of these pulse shapes and the occupied spectrum will change according to this selection.

4.3.3 Adaptable Transmit Power

UWB offers a suitable solution to the adaptable transmit power requirements of cognitive radio. Since the impulse radio is based on the transmission of discrete pulses, adapting the full transmit power is as simple and suitable as modifying the power of a single pulse. By adapting its transmit power, radio impulses can observe any set of spectral rules mandated upon the cognitive radio technique.

4.3.4 Adjustable Multiple Access

UWB is very flexible in multiple access conditions. By varying the number of chips in a frame, the number of multiple users can be determined. The task cycle in a frame can be in step with the condition for spectral occupancy. Therefore, from the goal of adaptive multiple access, UWB is a proper applicant for the cognitive radio application.

4.3.5 Limited Cost

UWB signals, which are essentially simple pulses, can be generated by low-cost analogy transmitter and receiver circuits, unless the pulses need to be digitally generated. The RF front-end required to send and imprison the UWB signals are unsophisticated and are available at reasonable prices. For these reasons, UWB system communication may be accomplished by using very low cost transmitters and receivers. This particularity of impulse radio makes it very attractive for cognitive radio, which aims at limited infrastructure and transceiver costs.

4.4 Combining UWB with Cognitive Radio

Combining UWB with cognitive radio can be mainly achieved in two ways, firstly performing the practical implementation of cognitive radio directly by impulse radio, and secondly enhancing the UWB system with cognitive radio through various sensing methods. The essential means of combining Ultra Wideband based Cognitive Radio Network UWB-CR is through spectrum sensing.

Our focus is on the spectrum sensing methods to detect the PU or SUs signals under different channel-noise conditions and then select the method that provides higher detection and lower probability of miss-detection for use in UWB-CR system nodes.

4.5 Characteristics of the Transmitter Signal

The signal to detect in our investigation is Direct Sequence Spread Spectrum (DSSS) [46]. The streaming bits, (1's and 0's) at r_b (data rate), are applied to the waveform, to create the data modulated signal $M(t)$. The DSSS signal uses Binary Phase Shift Keying (BPSK) for spreading and data modulation. In the BPSK configuration, 0^0 (phase value) represents +1 (bit value), while 180^0 (phase value) corresponds to -1 (bit value). $G(t)$, which is a gold coded spreading waveform, is used with chip rate r_c to spread the data modulated waveform.

The $s(t)$ structure for the DSSS signal is:

$$s(t) = \sqrt{2P} \cdot d(t) \cdot c(t) \cdot \cos(2\pi f_c t - \pi j) \quad (4 - 4)$$

where j is bits (1 or 0) for BPSK modulation and f_c and P are carrier frequency and average signal power respectively, $d(t)$ & $c(t)$ are the data and coded spreading waveforms.

4.6 Spectrum Sensing Algorithms

In this section we present Spectrum Sensing Methods to determine which method is most efficient, reliable and suitable for detecting transmitter signals under different fading and shadowing conditions to use in the UWB-CR system.

4.6.1 Matched Filter Detection (MFD)

A matched filter successfully requires demodulation of the signal to detect primary users [41]. That is, the CR needs a prior knowledge of the primary user signal, such as modulation type, bandwidth and pulse shaping. This data can be pre-stored in the CR memory.

Assuming that $X[k]$ is known to the receiver, in this case the test case for the optimal detector is [47]:

$$\mathcal{R} = \sum_K Y[k] X_p[k]^* \quad (4 - 5)$$

$\mathcal{R} > \gamma$ *decide signal present*

$\mathcal{R} < \gamma$ *decide signal absent*

where γ is the threshold of detection under any hypothesis $Y[k]$ which is jointly a Gaussian random variable, and R is also Gaussian, then

$$\begin{aligned} \mathcal{R} &\sim \text{Normal}(0, \sigma_n^2 \varepsilon) && \text{for } \mathcal{H}_0 \\ \mathcal{R} &\sim \text{Normal}(\varepsilon, \sigma_n^2 \varepsilon) && \text{for } \mathcal{H}_1 \quad \text{Where;} \end{aligned}$$

$$\varepsilon = \sum_N (X_p[k])^2 \quad (4 - 6)$$

the P_d and P_{fa} given as:

$$P_d = Q\left(\frac{\gamma - \varepsilon}{\sqrt{\varepsilon\sigma_n^2}}\right) \& P_{fa} = Q\left(\frac{\gamma}{\sqrt{\varepsilon\sigma_n^2}}\right) \quad (4 - 7)$$

Where σ_n^2 the variance of the noise and Q is the Q-function, defined as;

$$Q(t) = \frac{1}{\sqrt{2\pi}} \int_t^\infty e^{-\tau^2/2} d\tau \quad (4 - 8)$$

The number of samples required for the detector shown is:

$$K = [Q^{-1}(P_{fa}) - Q^{-1}(P_d)]^2 SNR^{-1} \quad (4 - 9)$$

Where P_d and p_{fa} are the probabilities of detection and false alarm detection respectively.

4.6.2 Energy Detection (ED)

Energy detection (ED) [48], is the most likely to be used detector. The energy detector calculates the power of the received signal and compares it to the threshold. The test statistic of the energy detector is given as:

$$\mathcal{R} = \sum_k^{K-1} X[k]^2 \quad (4 - 10)$$

Where K is known as the combination interval, and is selected to meet a target detection performance.

By using the notation of the widely-known Neyman Person hypothesis testing, that is the signal presence hypothesis (\mathcal{H}_1) and signal absence hypothesis (\mathcal{H}_0), the distribution of \mathcal{R} with large number of K under \mathcal{H}_0 and under \mathcal{H}_1 can be estimated by the Gaussian distribution with statistic [49]:

$$\mathcal{R} \sim \begin{cases} \delta(K\sigma_n^2, 2K\sigma_n^4), & \mathcal{H}_0 \\ \delta(K(\sigma_n^2 + |l|^2\sigma_s^2), 2K(|l|^2\sigma_s^2 + \sigma_n^2)^2), & \mathcal{H}_1 \end{cases} \quad (4 - 11)$$

Then the Neyman Pearson test for transmitter signal presence \mathcal{H}_1 is given as:

$$\Lambda(\mathcal{R}) = \frac{p(\mathcal{R};\mathcal{H}_1)}{p(\mathcal{R};\mathcal{H}_0)} > \gamma \quad (4 - 12)$$

Additionally, a binary hypothesis testing can be carried out by comparing \mathcal{R} with another value of threshold γ as follows

$$b_{\mathcal{R}} = \begin{cases} 1 & \text{if } \mathcal{R} > \gamma \\ 0 & \text{otherwise} \end{cases} \quad (4-13)$$

Where $b_{\mathcal{R}}$ is the variable of binary decision and the $b_{\mathcal{R}}$ is one bit information of signal processing during the energy observation period related to the thresholds γ .

The performance of the energy detector is calculated by P_d and P_{fa} given by:

$$P_{fa} = Q \left[\frac{\gamma - K\sigma_n^2}{\sqrt{2K\sigma_n^4}} \right] \quad (4-14)$$

$$P_D = Q \left[\frac{\gamma - K(\sigma_n^2 + |h|^2\sigma_s^2)}{\sqrt{2K(|h|^2\sigma_s^2 + \sigma_n^2)^2}} \right] \quad (4-15)$$

From (4-14) the γ is given by:

$$\gamma = Q^{-1}(P_{fa})\sqrt{2K\sigma_n^4} + K\sigma_n^2 \quad (4-16)$$

The number of samples K are given as:

$$K = \sqrt{2} \left[\frac{Q^{-1}(P_{fa}) + Q^{-1}(P_d)(|h|^2\mu + 1)}{|h|^2\mu} \right] \quad (4-17)$$

Where $\mu = \frac{\sigma_s^2}{\sigma_n^2}$ is the SNR of the transmitter signal.

Where σ_s^2 is the average received signal power. From (4-16) it is obvious that the energy detector requires noise power σ_n^2 to be known. Furthermore, it is known that the performance of the energy detector quickly worsens when the power of noise is flawed [50].

4.6.3 Cyclostationary Detection (CD)

In [51], the statistics of cyclostationary detection is explained as the test confirms for a shown cyclic frequency α the existence of conjugate or unconjugate cyclostationary from length T data sequence, exploiting a consistent and asymptotically estimator of conjugate or unconjugate cyclic autocorrelation function $\mathcal{R}_{xx^*}(\tau)$ is given as;

$$\mathcal{R}_{xx^*}(\tau) = \frac{1}{T} \sum_{t=0}^{T-\tau} x(t) x(t+\tau) e^{-j2\pi\alpha t} + \vartheta_{xx^*}^{\alpha}(\tau)$$

$$= \mathcal{R}_{xx^*}^\alpha(\tau) + \vartheta_{xx^*}^\alpha(\tau) \quad (4-18)$$

where $\vartheta_{xx^*}^\alpha(\tau)$ is the estimation error. When the presence of α has to be checked for a given lag τ considering the second order cyclostationary, the row vector consisting and asymptotic of conjugate cyclic autocorrelation function estimation defined as:

$$\tilde{r}_{xx^*}^\alpha(\tau) = [Re\langle \tilde{\mathcal{R}}_{xx^*}^\alpha(\tau) \rangle, Im\langle \tilde{\mathcal{R}}_{xx^*}^\alpha(\tau) \rangle] \quad (4-19)$$

$$r_{xx^*}^\alpha(\tau) = [Re\langle \mathcal{R}_{xx^*}^\alpha(\tau) \rangle, Im\langle \mathcal{R}_{xx^*}^\alpha(\tau) \rangle] \quad (4-20)$$

From using (18), can given by;

$$\tilde{r}_{xx^*}^\alpha = r_{xx^*}^\alpha(\tau) + \vartheta_{xx^*}^\alpha(\tau) \quad (4-21)$$

Where the estimation error is:

$$\vartheta_{xx^*}^\alpha(\tau) = [Re\langle \vartheta_{xx^*}^\alpha(\tau) \rangle, Im\langle \vartheta_{xx^*}^\alpha(\tau) \rangle] \quad (4-22)$$

given that:

$$\lim_{T \rightarrow \infty} \sqrt{T} \vartheta_{xx^*}^\alpha(\tau) \stackrel{D}{=} \mathcal{M}(0, \Sigma_{xx^*}^\alpha(\tau)) \quad (4-23)$$

Where $\stackrel{D}{=}$ denotes the conversion in distribution, and $\mathcal{M}(0, \Sigma_{xx^*}^\alpha(\tau))$ is normal distribution with mean 0 and covariance matrix $\Sigma_{xx^*}^\alpha(\tau)$.

The covariance matrix can be written as:

$$\Sigma_{xx^*}^\alpha(\tau) = \begin{pmatrix} Re \left[\frac{D_{xx^*} + C_{xx^*}}{2} \right] & Im \left[\frac{D_{xx^*} - C_{xx^*}}{2} \right] \\ Im \left[\frac{D_{xx^*} + C_{xx^*}}{2} \right] & Re \left[\frac{C_{xx^*} - D_{xx^*}}{2} \right] \end{pmatrix} \quad (4-24)$$

Where D_{xx^*} and C_{xx^*} are entries of $\Sigma_{xx^*}^\alpha(\tau)$ shown as

$$C_{xx^*}^\alpha(\tau_n, \tau_m) = \frac{1}{TL} \sum_{s=-L-1/2}^{(L-1)/2} W(s) F_{T, \tau_n} \left(\alpha - \frac{2\pi s}{T} \right) \cdot F_{T, \tau_m} \left(\alpha + \frac{2\pi s}{T} \right) \quad (4-25)$$

$$C_{xx^*}^\alpha(\tau_n, \tau_m) = \frac{1}{TL} \sum_{s=-L-1/2}^{(L-1)/2} W(s) \mathcal{G}_{T, \tau_n}^* \left(\alpha + \frac{2\pi s}{T} \right) \cdot \mathcal{G}_{T, \tau_m} \left(\alpha + \frac{2\pi s}{T} \right) \quad (4-26)$$

Where \mathcal{L} is length of spectral window W and

τ_n and τ_m are the lags fixed set. $\mathcal{G}_{T, \tau}(\omega)$ is defined as:

$$G_{T,\tau}(\omega) = \sum_{t=0}^{T-1} x(t)x(t+\tau) e^{-j\omega t} \quad (4-27)$$

The fact that the primary user signal is present is shown by the hypothesis $\mathcal{H}1$ and $\mathcal{H}0$ shows that the primary user signal is absent. Testing of the hypothesis may be formulated as follows:

$$\mathcal{H}1 : \tilde{r}_{xx^*}^\alpha(\tau) = r_{xx^*}^\alpha(\tau) + \vartheta_{xx^*}^\alpha(\tau); \text{ signal is present} \quad (4-28)$$

$$\mathcal{H}0 : \tilde{r}_{xx^*}^\alpha(\tau) = \vartheta_{xx^*}^\alpha(\tau); \text{ signal is absent} \quad (4-29)$$

The distribution of $r_{xx^*}^\alpha(\tau)$ under both hypotheses differs only mean if $r_{xx^*}^\alpha(\tau)$ not random.

The generalized likelihood function as the test statistic for the hypothesis test is given by:

$$\mathcal{J}^\alpha(\tau) = T_{xx^*}^\alpha(\tau) \tilde{\Sigma}_{xx^*}^{\alpha^{-1}}(\mathcal{J}) \tilde{r}_{xx^*}^{\alpha T}(\mathcal{J}) \quad (4-30)$$

It has been shown in [27] that under $\mathcal{H}0$, part of the distribution of the input signal, the $\mathcal{J}^\alpha(\tau)$ distribution joins to χ^2 central distribution with freedom $2K$ degrees where K is the observation integral with $K \geq 1$, this case makes measurement of the probability of false alarm P_{fa} possible for large observation length T for a certain threshold, which the asymptotically false alarm rate test under $\mathcal{H}0$ can given $\lim_{T \rightarrow \infty} \mathcal{J}^\alpha(\tau) \stackrel{D}{=} \chi_{2N}^2$.

For normal distribution under $\mathcal{H}1$ of the test statistic $\mathcal{J}^\alpha(\tau)$ shown as;

$$\lim_{T \rightarrow \infty} \mathcal{J}^\alpha(\tau) \stackrel{D}{=} \mathcal{M} \left(\begin{array}{c} T \tilde{r}_{xx^*}^\alpha(\mathcal{J}) \tilde{\Sigma}_{xx^*}^{\alpha^{-1}}(\mathcal{J}) \tilde{r}_{xx^*}^{\alpha T}(\mathcal{J}), \\ 4T \tilde{r}_{xx^*}^\alpha(\mathcal{J}) \tilde{\Sigma}_{xx^*}^{\alpha^{-1}}(\mathcal{J}) \tilde{r}_{xx^*}^{\alpha T}(\mathcal{J}) \end{array} \right) \quad (4-31)$$

4.6.4 Channelized Detection(CHD)

From [52], the basic channelized receiver detector consists of a set of N filters across a total bandwidth B_{total} . Channel outputs are jointly processed to appear at the required conclusion. The target is to exploit the power of channelization and develop settling techniques to find how many and what type of signals exist. The techniques considered include multirate filter processing as used for intercept receiver application,

multifilter outputs according to spectral and temporal correlation processing and analysis of cyclostationary between channel signals[53].

In Figure 4-3, an M subband channelized detector is shown. Received signal $s(t)$ is downconverted by a bank of equally spaced mixer frequencies f_0, f_1, \dots, f_M , which is then filtered by lowpass filter $\mathcal{F}(\omega)$, finally sampled by $(A/D)_s$ operating at $1/M$ of the full band receiver sampling frequency. The i_{th} sample of the k_{th} pulse in the m_{th} sub band can be given by:

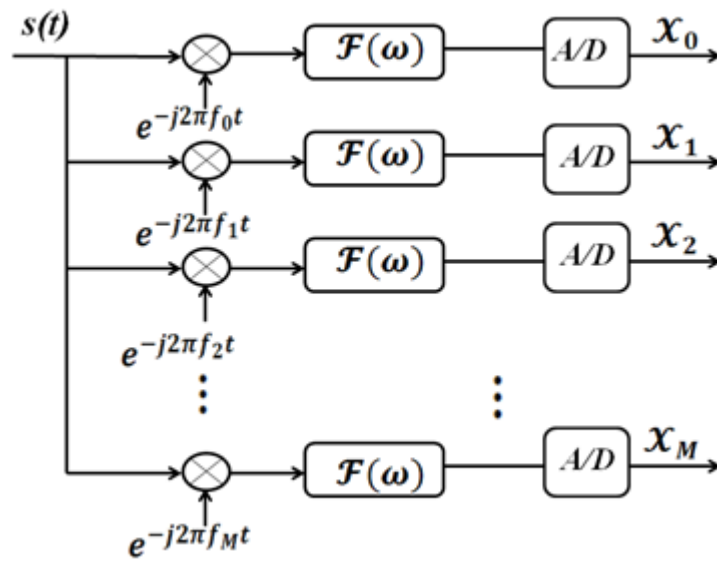

Figure 4-3: UWB Channelize with M subband.

$$\begin{aligned} \mathcal{X}_{k,m}\{i\} = & [\{a_k s(t - KT) + n(t)\} e^{-j2\pi f_m t}] \otimes \mathcal{f}(t) \parallel_{t=K(T+\epsilon)+iMT_s} = \\ & a_k e^{-j2\pi f_m T} s_m(k\epsilon + iMT_s) + n_{m,k}\{i\} \end{aligned} \quad (4-32)$$

Where

$$\begin{aligned} s_m(t) = & \langle s(t) \otimes (\mathcal{f}(t) e^{j2\pi f_m t}) \rangle e^{-j2\pi f_m t}, n_{m,k}\{i\} = \\ & n(t) e^{-j\omega_m t} \otimes \mathcal{f}(t) \parallel_{t=k(T+\epsilon)+iMT_s} \end{aligned} \quad (4-33)$$

and the impulse response of the lowpass filter is $\mathcal{f}(t)$.

For the detection process, the greatest value from the operated-on matrix is selected to compare with the threshold as the test statistic for the detector. The detection threshold is determined by measuring a sequence of matrices formed using the input noise power condition in relation to the required SNR.

To achieve the required probability of false alarm (p_{fa}), the threshold is calculated by using only input noise test statistics. The test statistics of the input signal with noise is compared with the threshold to determine the probability of detection (P_d) by dividing the sum of test statistics by the number of times it is run. This procedure is rerun for different values of SNR.

4.7 Performance of Detection Schemes

Here, comparisons of the described spectrum sensing methods are shown for different particular AWGN and fading channels. The BPSK modulation for DSSS suggested as the transmitter signal to detect with data rate 12.5 kHz, chip rate 1 GHz, time sample 0.01 ns and central frequency 5.25 GHz and channel bandwidth 500MHz. For the channelized detector $M=5, 20$ and $N_{ifft} = 256$.

Five different scenarios are considered, with different channel models. The DSSS signal model is the same for all scenarios. The following parameters are common for all scenarios:

- **DSSS signal model**
- **Probability of false alarm; $P_{fa} = 0.05, 0.1$**

4.7.1 Simulation Scenarios and Results

Scenario I: AWGN channel model

An AWGN channel is considered in the first scenario with different detectors. The simulation results are shown in Figures (4-4 & 4-9).

Scenario II: Shadowing channel model

The shadowing channel is considered in this scenario with the standard deviation of the Gaussian $\sigma = 5$ for different sensing algorithms. Simulation results are given in Figures (4-5 & 4-10).

Scenario III: Rayleigh fading channel model

The Rayleigh channel in the third scenario is considered for different sensing methods. Simulation results are presented in Figures (4-6 & 4-11).

Scenario IV: Rice channel model

The rice channel model in the fourth scenario is considered with Rice factor $K=5$ for different detectors. The simulation results are shown in Figures (4-7 & 4-12).

Scenario V: Rayleigh fading and shadowing channel model

The fifth scenario considers the Rayleigh fading and shadowing channel models, with Gaussian standard deviation $\sigma = 5$ in shadowing for different sensing methods. The simulation results are in Figures (4-8 & 4-13).

The simulated channel models are realized by construction in MATLAB[®] functions for Ricean, Rayleigh fading and shadowing channels.

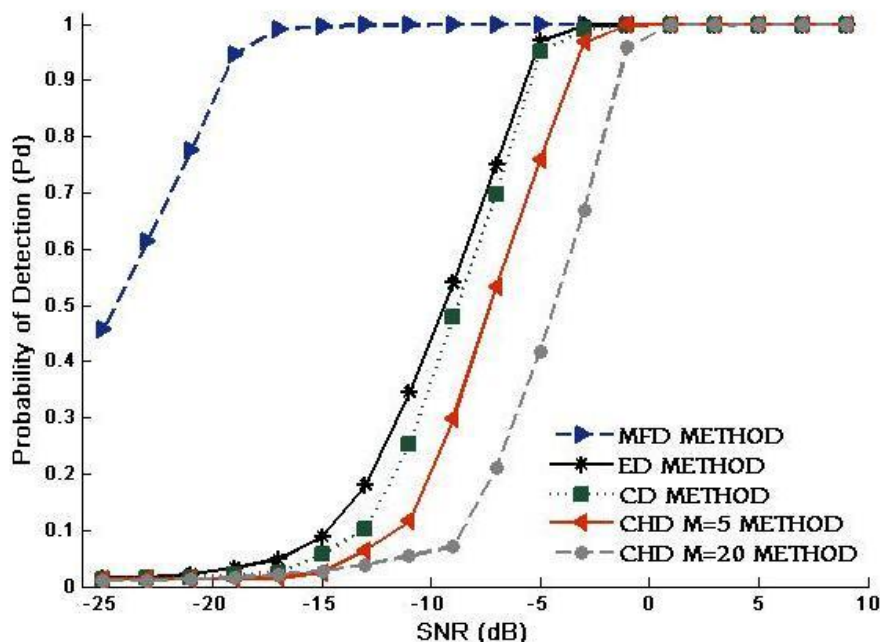

Figure 4-4: Probability of Detection (Pd) versus SNR for AWGN Channel Scenario (I).

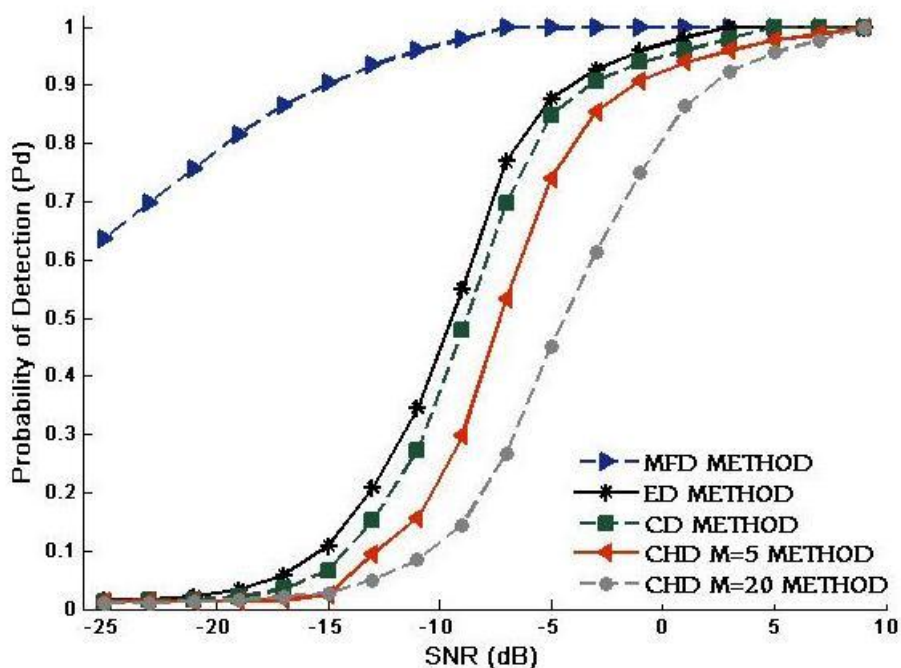

Figure 4-5: Probability of Detection (Pd) versus SNR for Shadowing channel Scenario (II).

The results show that utilizing the features of the primary signal can provide reliable detection in UWB-CR systems at slightly low SNR in the case of fading channels; this requires a priori knowledge of the parameters for the primary signal.

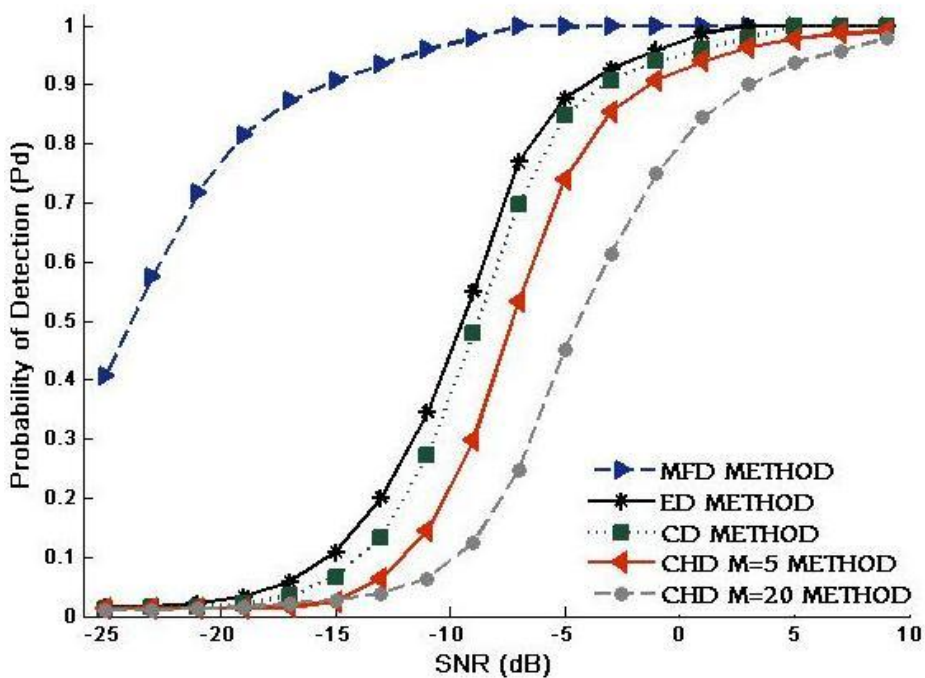

Figure 4-6: Probability of Detection (Pd) versus SNR for Rayleigh channel Scenario (III).

The probability of detection results in the graphs show that the CHD method over the range of channel bandwidths considered perform almost equally in all scenarios with a slight improvement in probability of detection P_d for the CHD method with $M=5$. The MFD method seems to have the best performance and gives high performance in all of the scenarios at the cost of extra computation.

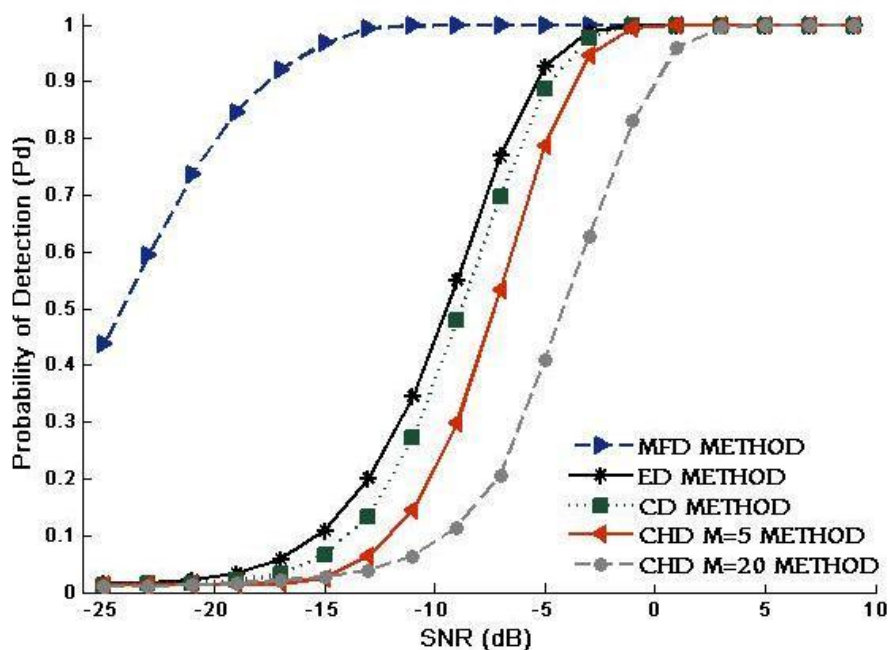

Figure4-7: Probability of Detection (P_d) versus SNR for Rice channel Scenario (IV).

Apart from the MFD method, the other presented methods do not depend upon the transmitter signal's parameter information. The energy detector and cyclostationary detection do not require any knowledge about the signal parameters. Additionally, the ED method has the best performance compared with CD and CHD methods, but its drawback is that it assumes perfect knowledge of the noise level. Therefore, the ED method works very well if the noise power is known; in practical scenarios, the noise power is estimated. Moreover, if there is interference in addition to the noise, such as from another secondary user, the energy detector would not be able to recognize the primary signal from the interfering signal, whereas the cyclostationary detector would. The advantage of the CD method lies in that there is no requirement to know the noise level variance. A general observation is that the energy detection (ED) method slightly outperforms the cyclostationary detection (CD) method in all scenarios, in the level $P_d \geq 0.1$. In real conditions, the probability of detection below this region will be unacceptable, as there

would be too much interference to the primary users, sharing the sensing information between cognitive nodes by using UWB.

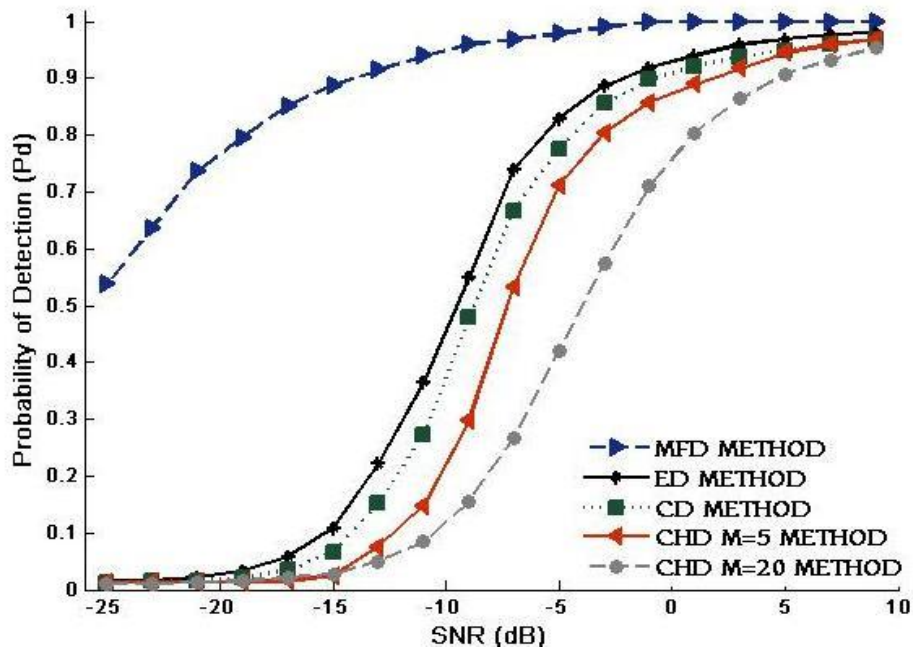

Figure4-8: Probability of Detection (Pd) versus SNR for Rayleigh and Shadowing channel Scenario (V).

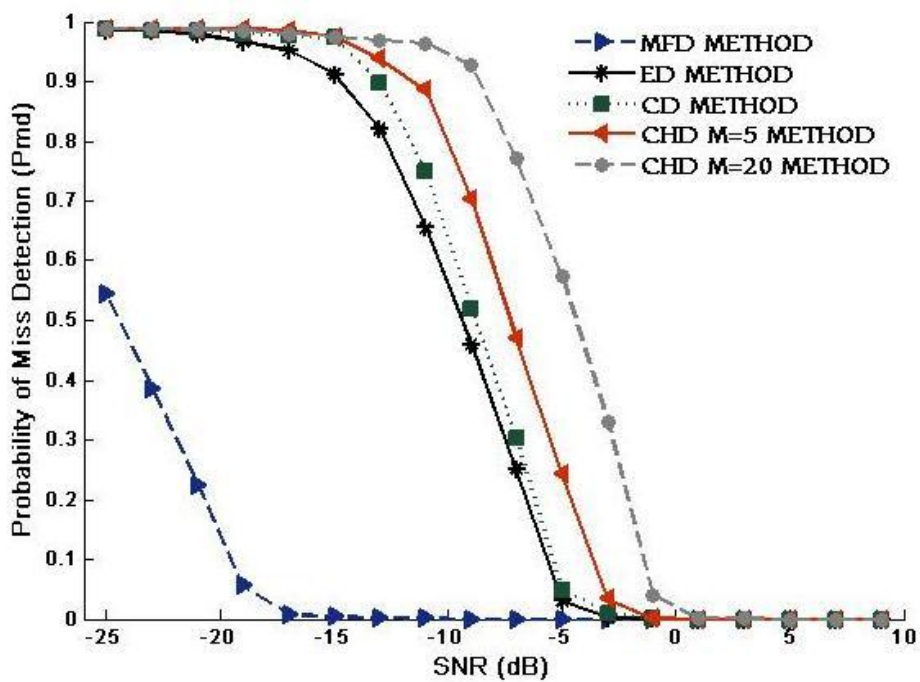

Figure4-9: Probability of Miss Detection (Pmd) versus SNR for AWGN channel Scenario (I).

The probability of miss-detection are evaluated for a false alarm probability (P_{fa}) of 0.05. All detection methods are simulated under different AWGN and fading channels and the probability of miss-detection is compared for the detectors' algorithms in all cases. Results show that the MFD method has less probability of miss-detection compared with other detectors, and ED, CD, CHD with $M=5$ have approximately the same miss-detection performance for different noise channels. Meanwhile, the CHD with $M=20$ has a higher probability of miss-detection; the result is that the MFD method is most suited for UWB-CR systems to detect primary transmitters.

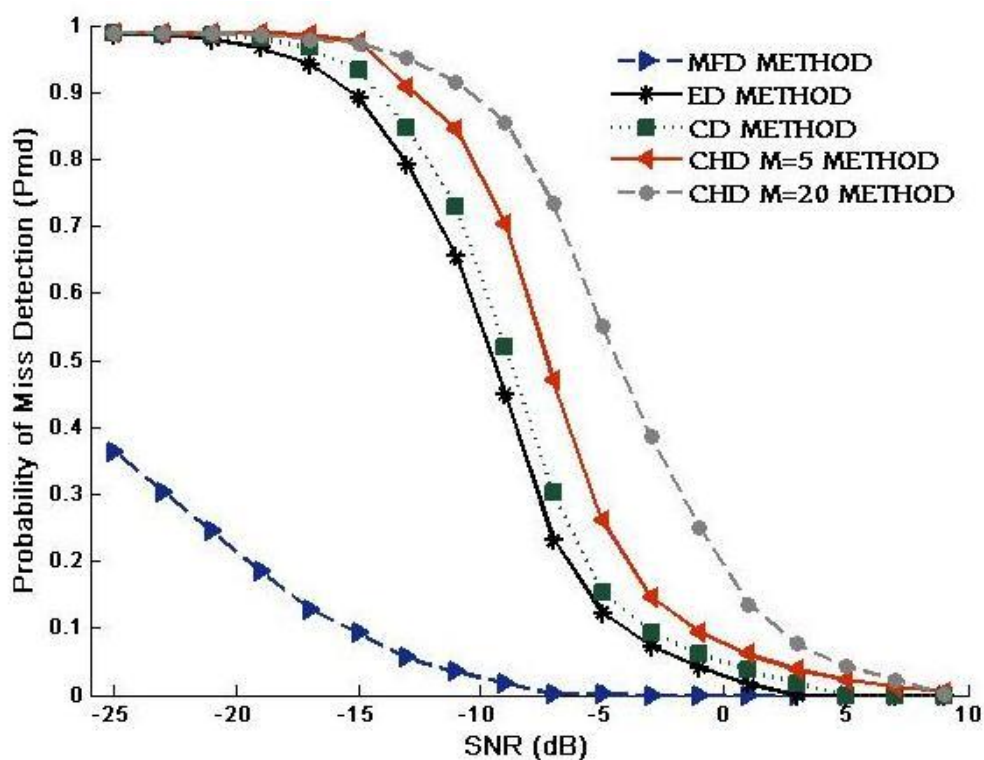

Figure 4-10: Probability of Miss Detection (P_{md}) versus SNR for Shadowing channel Scenario (II).

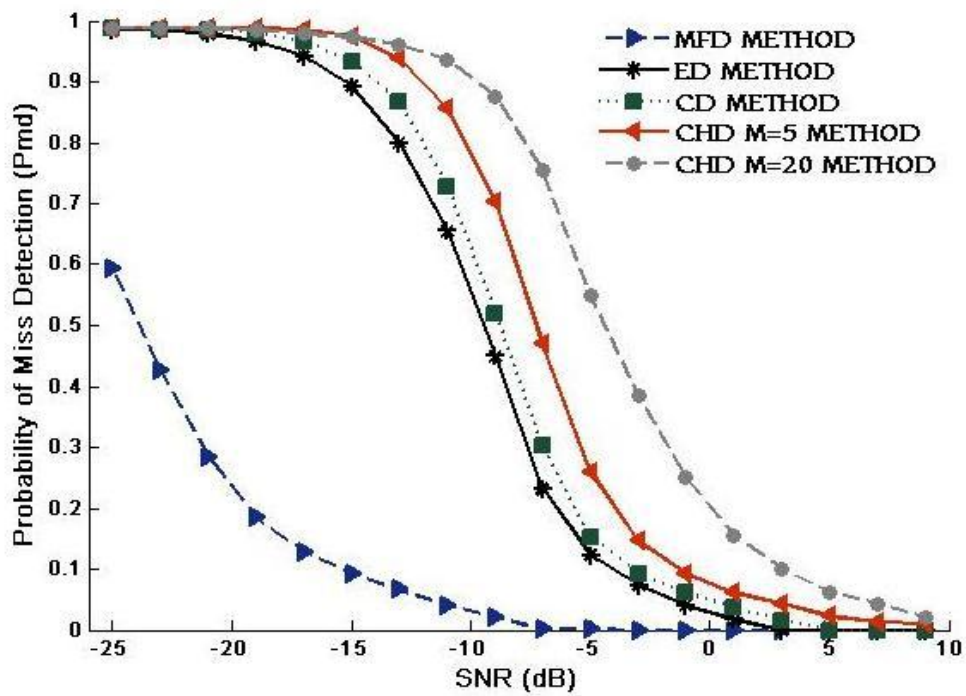

Figure 4-11: Probability of Miss Detection (Pmd) versus SNR for Rayleigh channel Scenario (III).

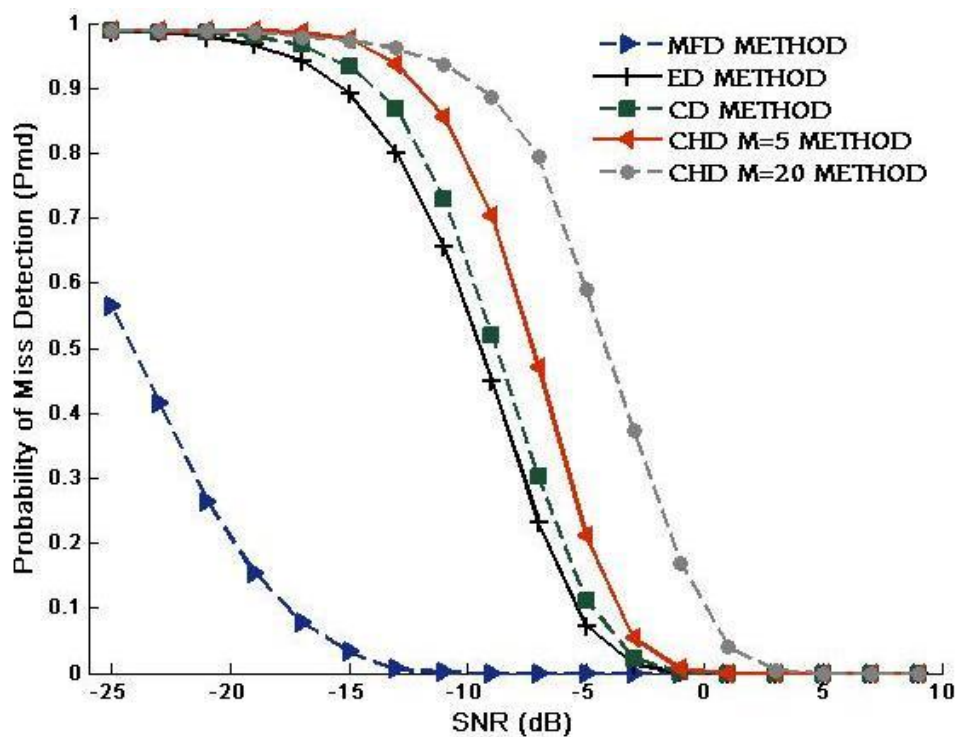

Figure 4-12: Probability of Miss Detection (Pmd) versus SNR for Rice channel Scenario (IV).

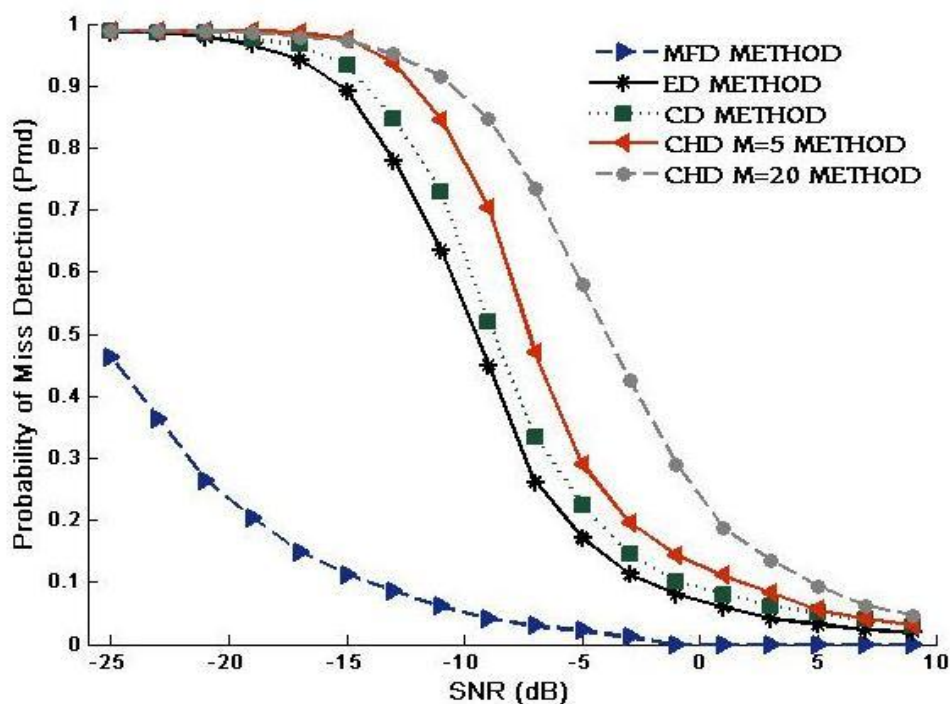

Figure 4-13: Probability of Miss Detection (Pmd) versus SNR for Rayleigh and Shadowing channel Scenario (V).

Figures 4-14 and 4-15 show the probability of detection (Pd) for different methods, for a false alarm probability equal to 0.05 & 0.1 under AWGN and Rayleigh & shadowing fading channels.

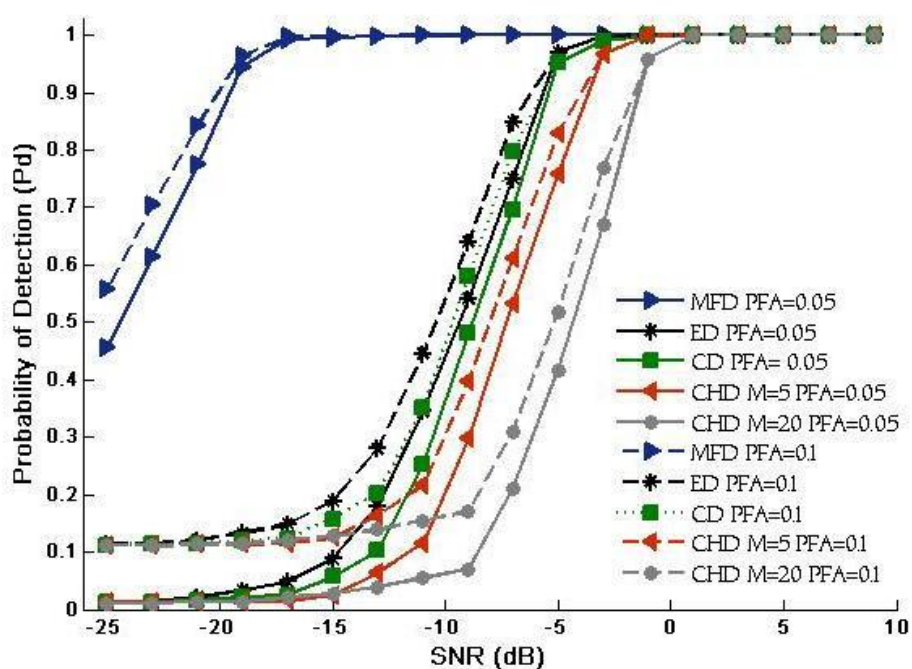

Figure 4-14: Probability of Detection (Pd) versus SNR for AWGN channel with various Pfa in different Sensing Methods.

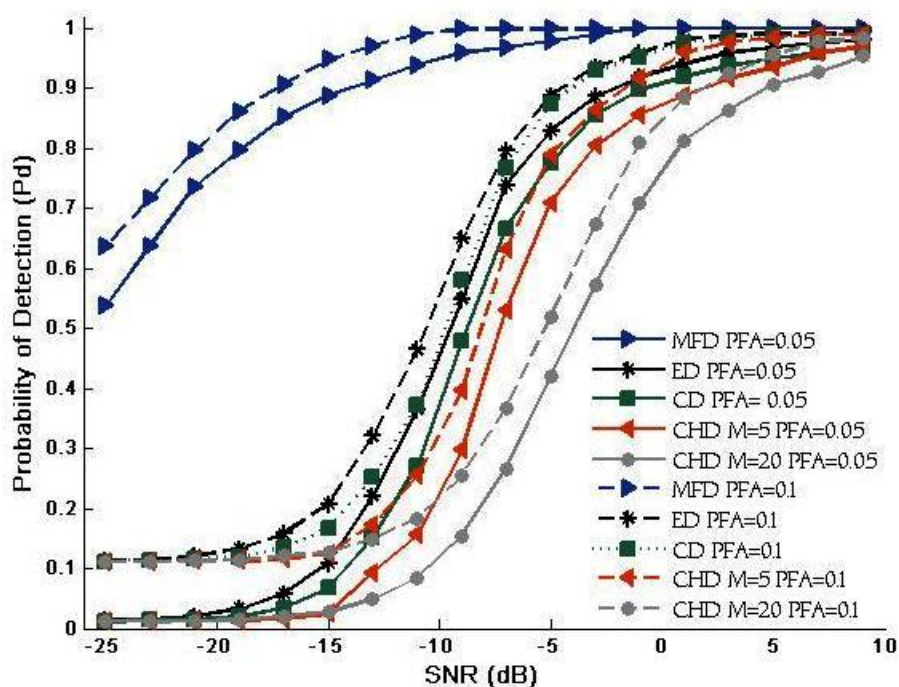

Figure 4-15: Probability of Detection (Pd) versus SNR for Rayleigh and Shadowing channel with various Pfa in different Sensing Methods.

Figure 4-16 shows the CD and CHD's Algorithms performance for miss-detection probability under Ricean, Rayleigh and shadowing noise channels are more or less equal, with a slight advantage for the CD algorithm.

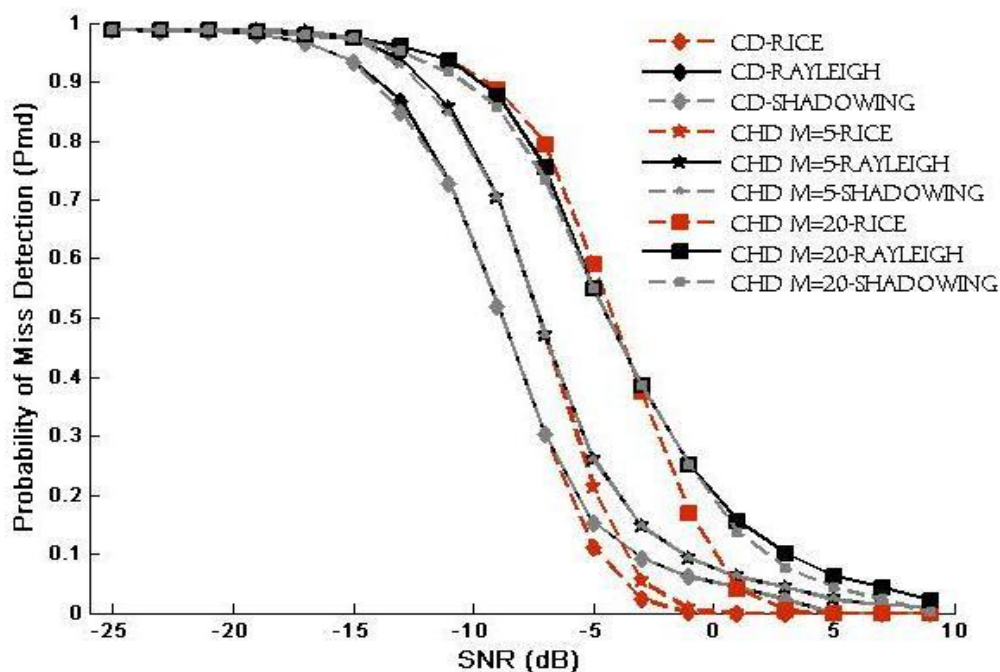

Figure 4-16: Probability of Miss Detection (Pmd) versus SNR for (CD, CHD M=5 and CHD M=20) Methods with various Fading Channels.

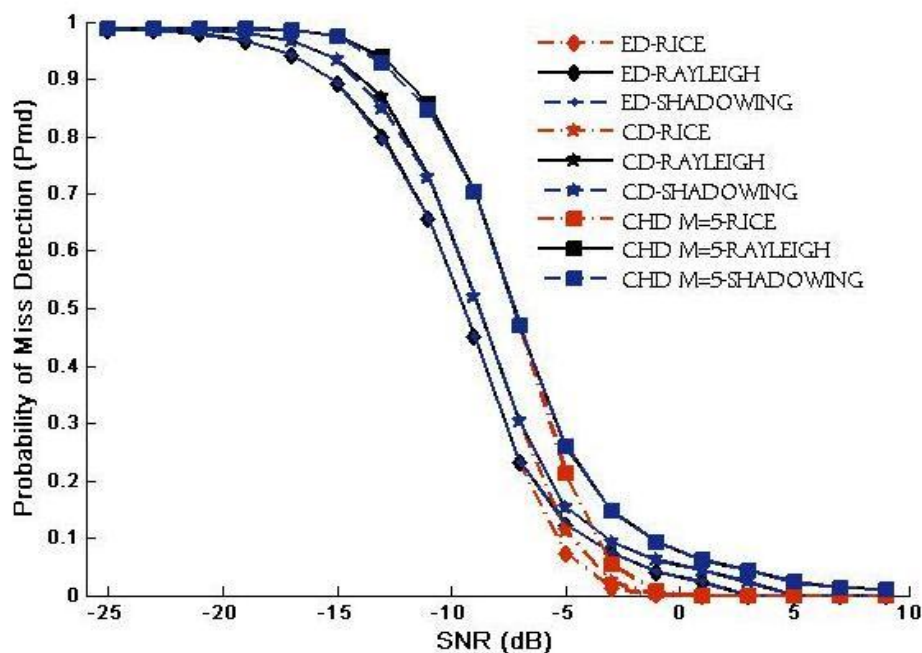

Figure 4-17: Probability of Miss Detection (Pmd) versus SNR for (ED, CD and CHD M=5) Methods with various Fading Channels.

The graphs in Figure 4-17 show that the ED, CD and CHD algorithms perform almost equally in terms of Probability of Miss-detection (Pmd) with Rice, Rayleigh and shadowing noise channels.

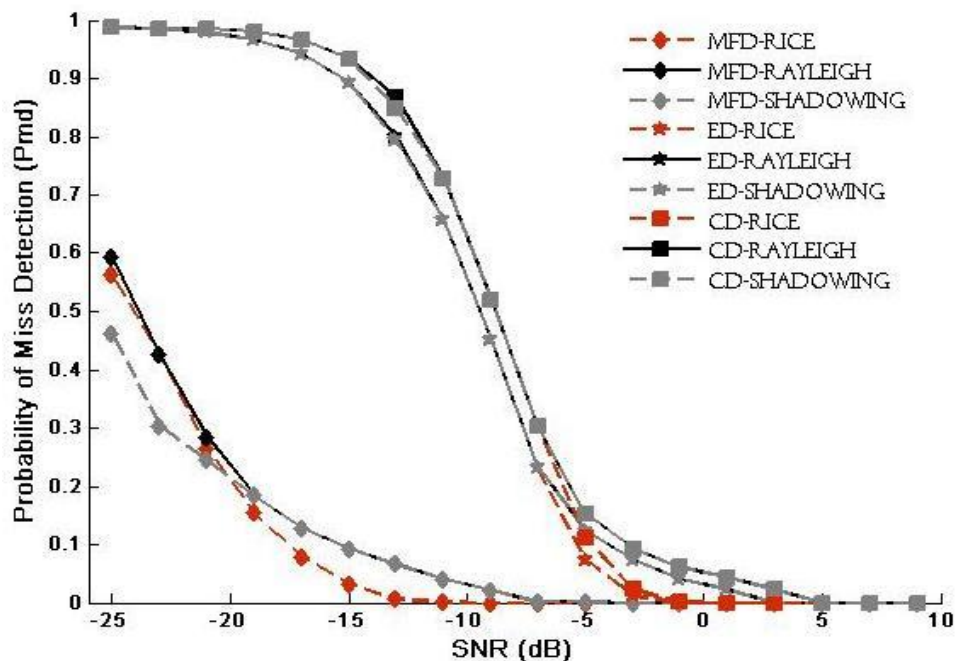

Figure 4-18: Probability of Miss Detection (Pmd) versus SNR for (MFD, ED and CD) Methods with various Fading Channels.

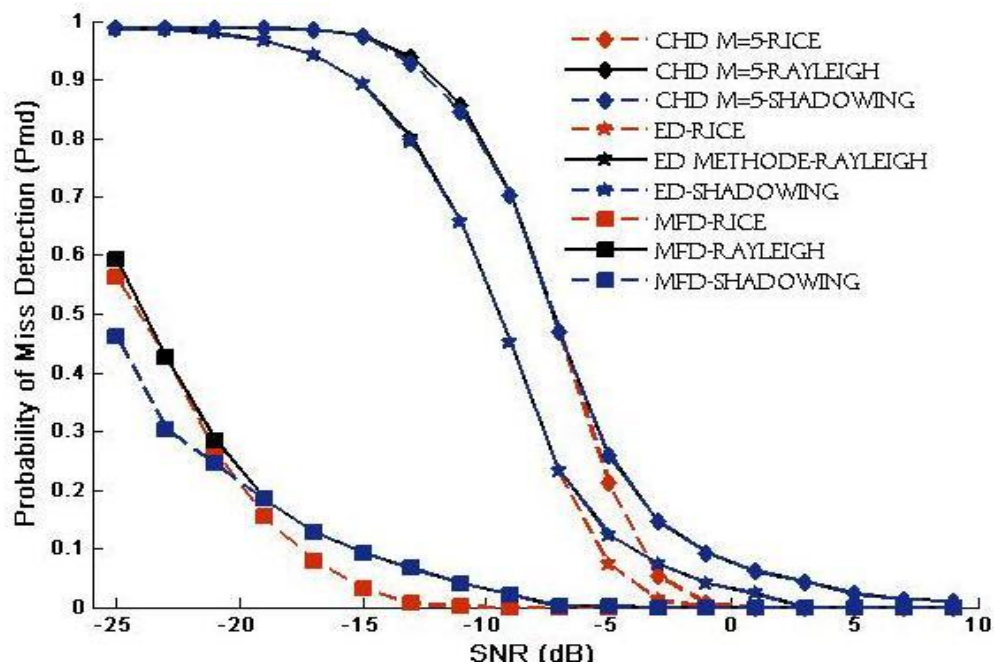

Figure 4-19: Probability of Miss Detection (Pmd) versus SNR for (CHD M=5, ED and MFD) Methods with various Fading Channels.

Figure 4-18 shows that the CHD, ED algorithms perform similarly in terms of Probability of Miss-detection (Pmd) for the MFD method with Rice, Rayleigh and shadowing noise channels.

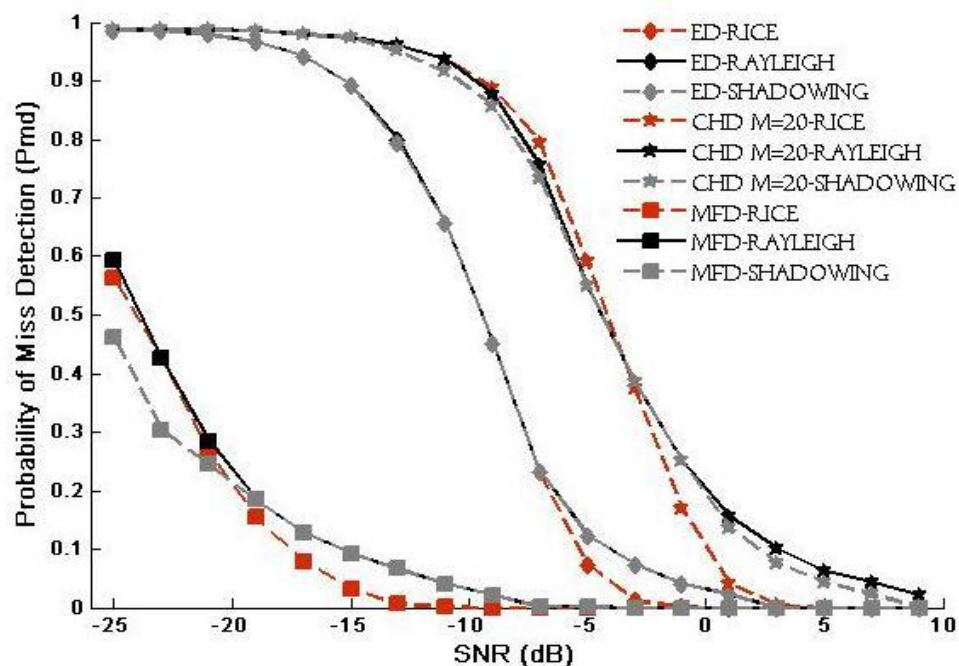

Figure 4-20: Probability of Miss Detection (Pmd) versus SNR for (ED, CHD M=20 and MFD) Methods with various Fading Channels.

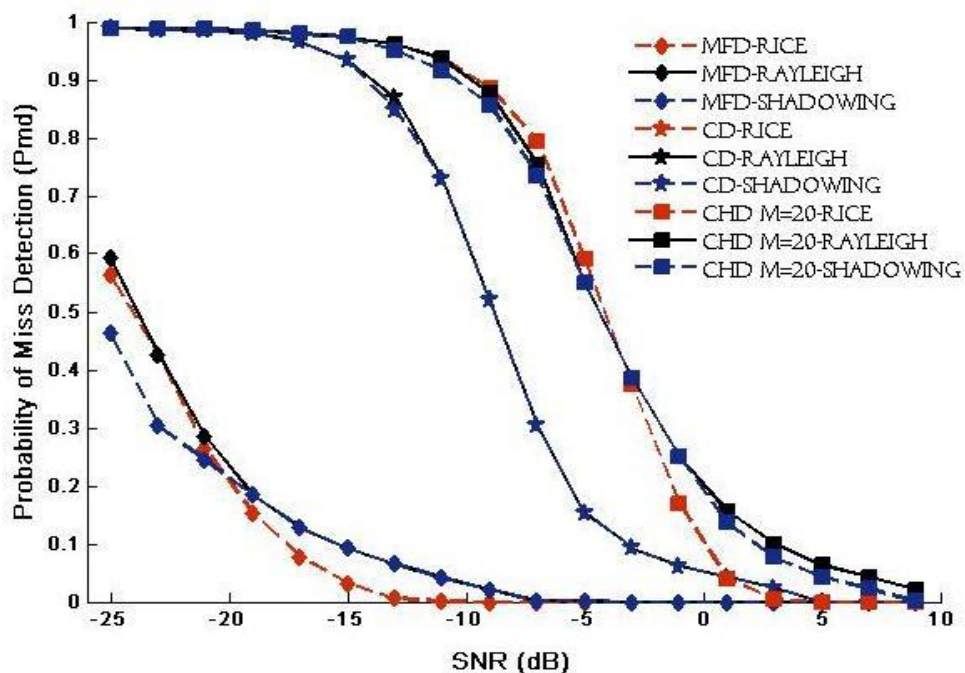

Figure 4-21: Probability of Miss Detection (Pmd) versus SNR for (MFD, CD and CHD M=20) Methods with various Fading Channels.

Figure 4-19 shows that the CHD algorithm perform almost equally with a slight advantage for the ED method and with considerable improvement in terms of Probability of Miss-detection (Pmd) for the MFD method with Rice, Rayleigh and shadowing noise channels.

Figures 4-20 and 4-21 show that the CHD algorithm perform almost equally with a slight advantage for the ED an CD methods, and considerable development in terms of Probability of Miss-detection (Pmd) for the MFD method with Rice, Rayleigh and shadowing noise channels.

4.8 Summary

We can summarize the key finding of applying spectrum sensing algorithms to detect spectrum band in Ultra Wideband-based Cognitive radio networks by:

1. Various sensing techniques for the detection of transmitter signals has been considered in this chapter.
2. The advantages of the different detectors have been proved by simulation.
3. A general solution for the best and reliable detector has been proposed and a suitable Matched filter detection method under different fading channels is used for detecting transmitter signals through UWB-Cognitive Radio Network, especially if all signal parameter information required for the detection of primary users are known for cognitive radios.
4. Another solution to the same problem is considered by using the energy detection scheme, because it appears to provide good performance and is a good candidate for implementation in UWB-Cognitive Radio spectrum sensors.

This chapter offers solutions aimed at improving the probability of detecting primary transmitter signals that provide a better experience to the cognitive radio users in terms of selecting a suitable detector. The Matched falter detector in UWB-CR under different fading channel conditions improves the detection probability performance even when different fading channels are used.

CHAPTER 5

Cooperative Spectrum Sensing in Cognitive Radio Networks

5.1 Introduction

Cognitive radio networks, comprising many randomly-deployed, low cost, low power, functional nodes co-operating to achieve a common goal, are used in various communication application systems [54]. Cognitive radio nodes can detect and identify primary users' signal data in the spectrum channel bands in order to reuse unoccupied spectrum and spectrum holes and to track primary transmitters. Cognitive radio network nodes can particularly be used to implement primary networks transition task, such as spectrum sensing. A cognitive radio network consisting of radio frequency nodes that are distributed over an area of use can be utilized to detect the signals of primary users to determine their frequency channel bands. Figure 5-1 shows a scenario of this idea. Through cooperation amongst the CR nodes, the detection performance and accuracy of estimation are improved, and the time required for detection is minimized, maximizing the life of the CR nodes [55].

In the sensing stages, every SU senses individually (local sensing), and all local decision information is reported to the common receiver during the reporting stage. Finally, the common receiver applies one of the fusion rules to combine all the local observation data in order to make a global decision on the presence or absence of the PU during the decision making stage. However, when local observations are forwarded to a common receiver through fading channels, the performance of sensing can be severely degraded. In order to overcome this problem, several works propose cluster-based cooperative sensing methods [56-57]. In these methods, few cognitive radio users with similar location are collected into a cluster. In every cluster a favourable user is selected to be cluster header.

This approach significantly improves the sensing performance in comparison with traditional method.

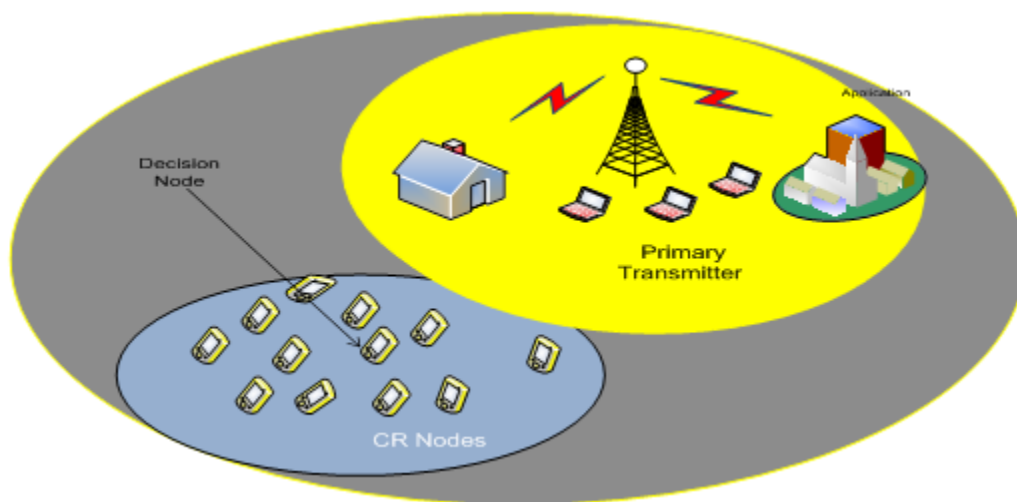

Figure 5-1: A Scenario of Cognitive Radio Network to detect Primary Transmitter.

In this chapter we used the MRSS method which is a type of Energy Detection method for the cooperative spectrum sensing task [58] and cluster-based cooperative spectrum sensing. The idea is a first step for developing two-bit hard combination method [59]. The following sections provide brief descriptions and investigation of the most important task, methods and simulation results. We propose two techniques, which are collaborative wideband spectrum sensing in cognitive radio network and cluster-based cooperative wideband spectrum sensing with softened hard combination scheme in cognitive radio systems [60].

5.2 Collaborative Wideband Spectrum Sensing in Cognitive Radio Networks

This section presents the proposed cognitive radio networks based collaborative wideband spectrum sensing method to detect primary signals and determine their frequency bands in order to reuse unoccupied bands. Multi-resolution spectrum sensing method, collaboration spectrum sensing and modified two-bit hard combination schemes are considered. Figure 5-2 shows the flow chart of the cognitive radio network based collaborative wideband spectrum sensing proposed in this chapter. In the first stage, all nodes in the cognitive radio network apply coarse resolution sensing to achieve a fast examination of the spectrum that is needed in the second stage; modify two-bit hard

combination combines the results of the coarse resolution sensing to detect the signal and to determine frequency bands that require further detailed examination. Then, fine resolution sensing is applied to these frequency bands to narrow down the spectral bands of the signals in the third stage. In the final decision stage, the channels processed from every node through modify two-bit combination stage, to determine the primary signal channel and weak channel that are combined to provide occupied channels for the final list. To avoid interference to the primary and cognitive radio users (using vacant spectrum or frequency holes in the primary spectrum), information is reported to the decision node. Thus, the list of vacant channels will be used to allocate spectrum and distribute to cognitive radio users in the unoccupied spectrum of primary users.

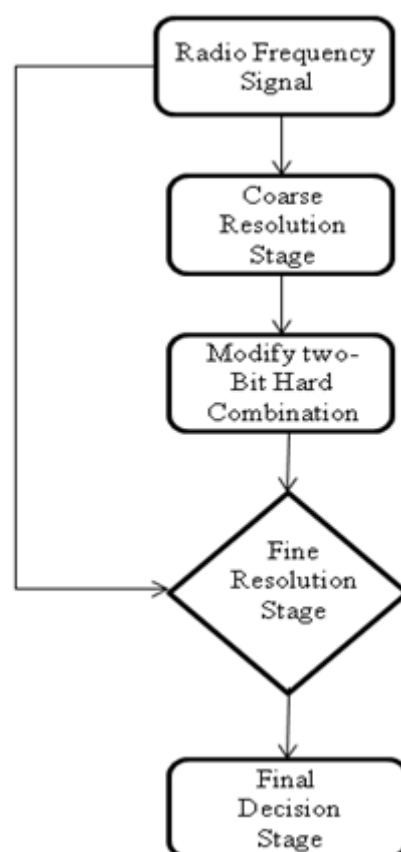

Figure 5-2: Block Diagram of the proposed model stages.

The method is described below:

1. A CR node, chosen as the decision node, conducts coarse resolution spectrum sensing over the complete bandwidth of the primary spectrum and decides three thresholds, which are used to separate the observation range into four areas [59].

2. The information from these thresholds are sent to all other CR nodes , so that every node should apply the same thresholds. Then all nodes apply coarse resolution spectrum sensing to the band.
3. CR Nodes send information to the decision node about the observed areas of energy as two-bit values.
4. Using the proposed approach, the decision node will determine the spectrum bands on which fine-resolution spectrum sensing will be implemented and which CR nodes will apply fine-resolution spectrum sensing on the chosen spectrum bands. In particular, the highest energies that the nodes sense in the determined spectrum bands have fine resolution sensing applied to them.
5. To determine the frequency bands of the primary signals, each CR node applies the maximum of the three threshold values after fine resolution sensing, and this data is reported to the Medium Access Control (MAC) unit - occupied , unoccupied and weak primary spectrum channel bands.

The following explains in detail the schemes used in the proposed method.

5.3 Multi-Resolution Spectrum Sensing Method

MRSS is classified as one of the energy detection techniques [61]. This technique senses the spectrum at two different resolutions, coarse and fine resolution. In the MRSS method, the coarse resolution spectrum sensing examines the whole system bandwidth [8], thus providing a quick sensing of the primary signal spectrum. Subsequent to this, fine resolution sensing spectrum is implemented on the spectral bands where more searching is necessary. With this technique, the whole system bandwidth is not tested comprehensively, therefore the power consumption and the time of sensing are considerably reduced.

This technique is classified as a wavelet-based approach [61], which is explained below.

5.3.1 Wavelet-based MRSS

Figure 5-3 shows the block diagram of the suggested wideband analogue wavelet-based MRSS method. The pulse duration of the wavelet generator and the sinusoidal

functions for frequencies are changed to examine the spectrum at different resolutions in the wavelet-based MRSS method. In order to implement different sensing resolutions, width T_y and frequency f_{sweep} are adjusted, and to examine the frequency band of the primary spectrum, the search frequency value f_r is changed. Large T_y or small f_{sweep} offers fine resolution sensing, while smaller T_y or a large f_{sweep} offers coarse resolution sensing. As shows in Figure 5-3, first able, T_y which is a wavelet pulse with duration is multiplied with sinusoidal functions (cosine and sine) that have the same frequency as the search frequency. After that, the multiplication products are combined by the received RF signal $s(t)$. The output is then integrated in the analogue correlator. The result of the analogue correlators is initially squared and then summed. The spectral density at f_r results from the square root of this summation [61]. The process of this method is as follows:

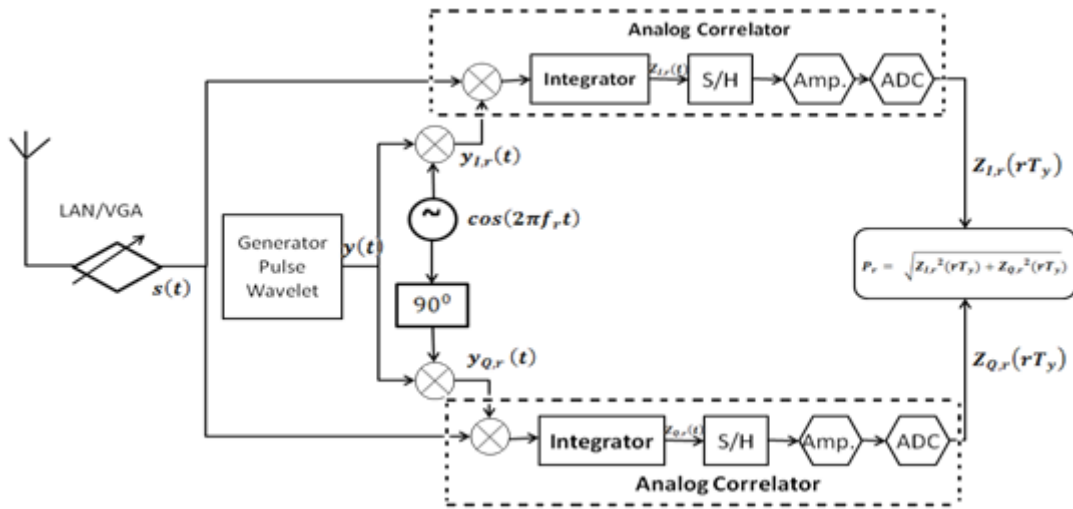

Figure 5-3: Block Diagram of Wavelet-Based MRSS Technique [58].

$$y_{I,r}(t) = y(t) \cos(2\pi f_r t) \quad \text{for } r = 0, \dots, R \quad (5-1)$$

$$y_{Q,r}(t) = y(t) \sin(2\pi f_r t) \quad \text{for } r = 0, \dots, R \quad (5-2)$$

Where $y(t)$ is a wavelet pulse, $f_r = (f_{start} + r f_{sweep})$ is the search frequency value is r^{th} and $R = \text{around}[(f_{stop} - f_{start})/f_{sweep}]$ is the number of search frequency values.

The frequency period ($f_{stop} - f_{start}$) is investigated by sweeping f_r by the amount of f_{sweep} . The spectral contents $Z_{I,r}(t)$ and $Z_{Q,r}(t)$ of $s(t)$ input signal are calculated by analogue correlators for every f_r , as shown in (5-3) and (5-4);

$$Z_{I,r}(t) = \frac{1}{T_y} \int_{rT_y}^{(k+1)T_y} [s(t)\{y(t)\cos(2\pi f_r t)\}] dt \tag{5-3}$$

$$Z_{Q,r}(t) = \frac{1}{T_y} \int_{rT_y}^{(k+1)T_y} [s(t)\{y(t)\sin(2\pi f_r t)\}] dt \tag{5-4}$$

The following equation (5-5) shows the spectral density is represented by the magnitude P_r at frequency f_r .

$$P_r = \sqrt{Z_{I,r}^2(rT_y) + Z_{Q,r}^2(rT_y)} \tag{5-5}$$

Where, the discrete value of $Z_{I,r}(t)$ and $Z_{Q,r}(t)$ are $Z_{I,r}(rT_y)$ and $Z_{Q,r}(rT_y)$, at every wavelet pulse T_y width the $Z_{I,r}(rT_y)$ and $Z_{Q,r}(rT_y)$ are obtained sampling. The output is averaged by calculating P_r more than once; averaging reduces the level of the noise floor and makes the signal more noticeable.

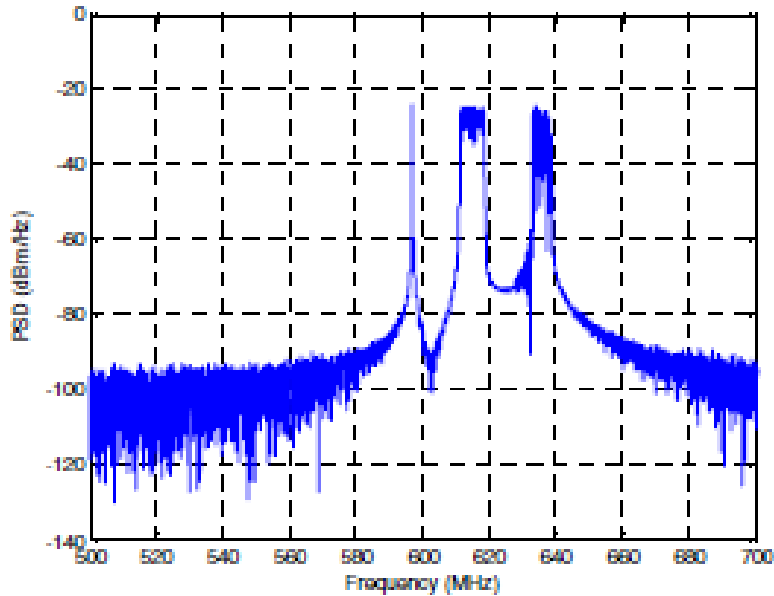

Figure 5-4: Output for Different Primary signal using MRSS Spectrum Sensing Technique [62].

Coarse and fine resolution spectrum sensing can be clearly shown by investigating the results of this method [62]. Figure 5.4 shows the spectrum for the input primary signal to the system, which is shown in Figure 5-3.

Figure 5-4 shows three different primary signals in the central area of the spectrum: 597 MHz, 615 MHz and 633 MHz are carrier frequencies, with bandwidths of 200 KHz, 6 MHz and 7 MHz respectively.

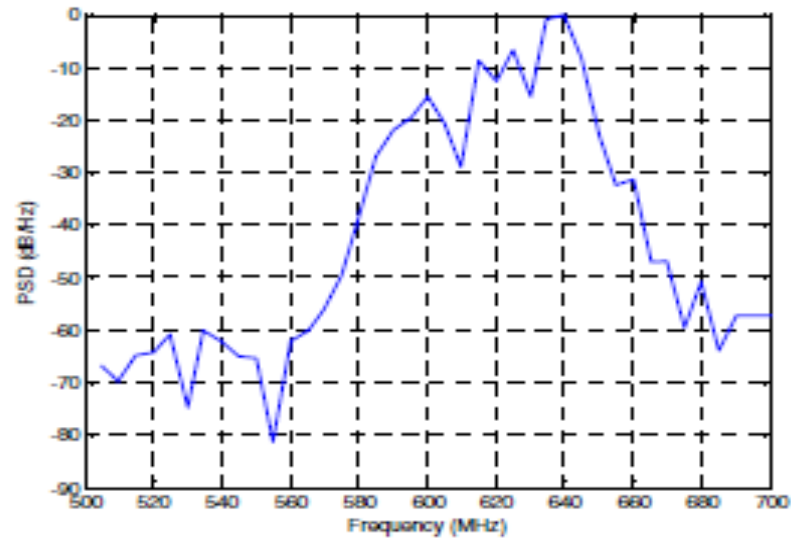

Figure 5-5: MRSS result for coarse resolution Sensing [62].

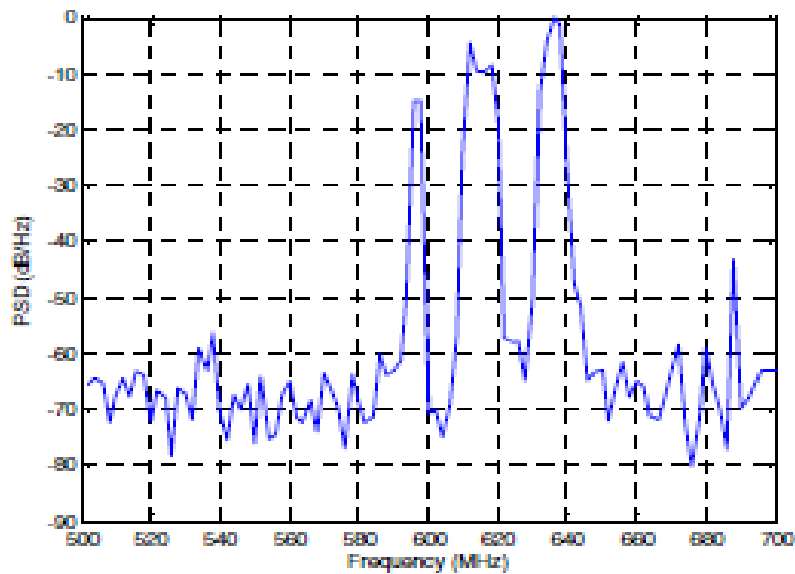

Figure 5-6: MRSS result for fine resolution sensing [62].

The result of the coarse resolution spectrum sensing is shown in Figure 5-5, with implementation parameters, width of window pulse $T_y = 0.1 \mu s$ and frequency $f_{sweep} = 5 MHz$.

Figure 5-6 shows results for the fine-resolution spectrum with parameters, width of window pulse $T_y = 1 \mu\text{s}$ and frequency $f_{\text{sweep}} = 2\text{MHz}$.

The window pulse width T_y and frequency f_{sweep} determine the resolution of this method. Comparing figures 5-5 and 5-6 shows that the fine resolution sensing in Figure 5-6 gives better primary signal detection performance during the sensing resolution stage.

The main advantage of this technique is that a wavelet pulse works as a band pass filter and rejects the noise in the input primary transmitted signal. A filter bank is also not needed, because of adjusting the frequency f_{sweep} and the wavelet pulse width T_y . Furthermore, since most of the work is done in the analog domain, the complexity of the digital circuit can be reduced considerably and real time sensing and reduced power are achievable.

5.4 Fusion Schemes in Cooperative Spectrum Sensing

As mentioned in Chapter 2, received signal strength can be very weak under fading or shadowing conditions and this problem can prevent a node from detecting a primary transmitter signal. There is another challenge such as noise, and to solve this problem a technique called feature detection is used [63].

The idea behind collaborative spectrum sensing in a cognitive radio network is the cooperation of cognitive radio nodes in determining the primary transmitted signal in the RF spectrum. Decision nodes will receive all information (test statistics) from the nodes about the existence of the primary transmitted signal, with the decision node usually being one of the nodes. During this collaboration detection, the effects of noise, fading and shadowing can be reduced. If the primary transmitter signal is not detected by one cognitive radio node, it will probably be detected by others. Furthermore, individual nodes need high sensitivity to detect the primary transmitter signal compared to the cooperative spectrum sensing, which improves the overall detection sensitivity. This leads to minimizing the hardware and complexity, because nodes work with less sensitive detectors.

Hard fusion and soft fusion are different schemes in the cooperation spectrum sensing and can also be also called hard combining and soft combining, respectively. Each scheme sends different types of information to the decision node.

Below both schemes (hard fusion and soft fusion) are introduced, which build the basis of the proposed approach that is explained in detail later.

5.4.1 Soft combining

In the soft fusion scheme, cognitive radio nodes send all their scanning spectrum data information without making any decision to the decision node. By collecting these data, the decision node makes the final decision. The advantage of this scheme compared with decision fusion provides better performance, but it has more overhead than decision fusion [64].

5.4.2 Hard combining

In this scheme different secondary user nodes are individually sensed and then send their binary decision information about the existence of the primary transmitted signal to the master node (decision node) that makes the final decision concerning the detection of the primary signal [65]. The existence of the primary signal can be determined by comparing the energy of the sensed with the threshold. The binary signal is sent from each cognitive node as one-bit either 1 for signal present or 0 for absent.

The final decision node uses three main rules [66]:

i. OR Rule

The OR Rule: the decision node decides that the primary signal is present, since one of the cognitive radio nodes sensed the primary user's signal and sent a logical 1 to the decision node.

ii. AND Rule

The AND Rule implementation is: decision node decides that the primary signal is present by collecting all information (logical 1) from the cognitive radio nodes (all cognitive radio nodes confirmed that the primary signal exists).

iii. Majority Rule

The Majority Rule, the third rule, is based on the decision node deciding that the primary signal is present by receiving information from the majority of the cognitive radio nodes that confirm the primary signal exists through the sending of logical 1.

Assuming there are i^{th} CR nodes that receive a sample of the primary signal j^{th} , as equation (5-6) shows:

$$x_{ij} = \begin{cases} m_{ji} & H_0 \\ \sqrt{P_{av,i}} a_{ij} + m_{ij} & H_1 \end{cases} \quad (5-6)$$

Where;

$1 \leq i \leq N$: N is the number of CR nodes.

$1 \leq j \leq S$: S is the number of samples.

$\sqrt{P_{av,i}} a_{ij}$: is the received primary signal.

$P_{av,i}$: is the average received power primary signal

a_{ij} : Zero-mean complex Gaussian random variable and variance.

n_{ij} : is white of noise.

H_0 : is the hypothesis of I primary signal .

H_1 : is the hypothesis of present primary signal

A test statistic at the i^{th} CR node of observed energy is obtained as shown in equation (5-7);

$$Z_i = \sum_{j=1}^S x_{ij}^2 = \begin{cases} c_{i0} & H_0 \\ (1 + p_{av,i})c_{i1} & H_1 \end{cases} \quad (5-7)$$

With S degrees of freedom: random variable of distributed for central chi-square is c_{i0} and c_{i1} In the equation (5-7) the decision node collected the test statistics information from all CR nodes.

In the equation (5-8) ;

$$LR(Z) = \frac{Pr(W|H_1)}{Pr(W|H_0)} \begin{cases} > \\ < \end{cases} \lambda \quad (5-8)$$

Decision criterion is made by applying Neyman-Pearson.

Where λ is the threshold which is from the probability of false alarm calculated and

$Z = (Z_1, Z_2, Z_3, \dots, \dots, Z_N)$.

There is a scheme, called two-bit hard combination, that was later proposed as a hybrid combining (hybrid fusion) scheme. This scheme is explained in the next page.

5.4.3 Two-bit hard combination scheme

The main advantages of the Two-bit hard combination scheme are greater performance as obtained in the data fusion (soft combination) approaches and lower overhead as obtained in decision fusion (hard combination) approaches [59]. The main

parameters of the Two-hard combination scheme is $(\lambda_1, \lambda_2, \text{ and } \lambda_3)$ thresholds for the CR nodes corresponding to the probability of false alarm or probability of detection; the whole observation area is divided into more than three regions as shown in Figure 5-7.

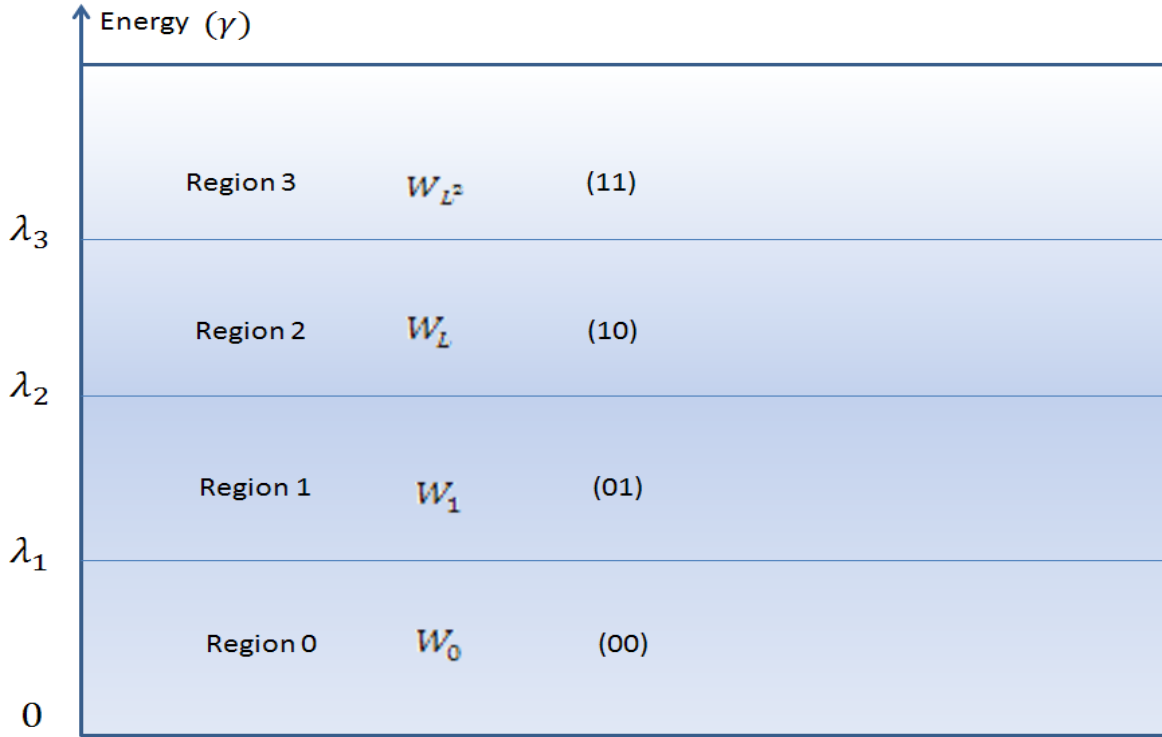

Figure 5-7: Regions of Observation Energy in the Two-bit Hard Combination.

The Two-Hard Combination is proposed to be implemented such that the successful presence of the primary transmitter signal is if:

- One of the observed energy values falls in region 3.
- Or L ones of the observed energy value fall in region 2
- Or L^2 ones of the observed energy values fall in region 1

in other words, each region is allocated a figure weight, as follows:

$$w_0 = 0, w_1 = 1, w_L = L, w_{L^2} = L^2$$

The weighted decision is given by [64]:

$$N_b = \sum_{j=0}^3 w_j N_j \tag{5-9}$$

From equation (5-9), N_j is the number of observed values falling in the j^{th} region. Then N_b compared with threshold L^2 , if the N_b is greater than or equal to L^2 , primary transmitted signal is present, otherwise absent.

In this scheme, the thresholds λ_1 , λ_2 , λ_3 and L are determined by using the Neyman-pearson criterion to increase the average overall probability of detection of all the cognitive radio nodes in the network for a given overall probability of false alarm that optimizes the performance of detection.

5.4.4 Proposed Approach Scheme.

This chapter proposes the modify two-bit hard fusion for cooperative spectrum sensing. The main design of the two-bit hard combination scheme proposed in [59] is used. Three thresholds are used to divide the whole range of observed energy into four areas. The decision node collects two-bit information from each cognitive radio after taking measurements in the energy regions of interest. If each node sends more than two-bits of information for the region of observed energy, this will lead to greater overhead. It is demonstrated that soft combination methods have considerable performance enhancement over conventional hard combination [6]. The development proposes a new hard combination method with only two-bit overhead for each CR user, which exhibits much better performance than the softened-hard combination method and conventional hard combination methods with only one-bit overhead for each CR user.

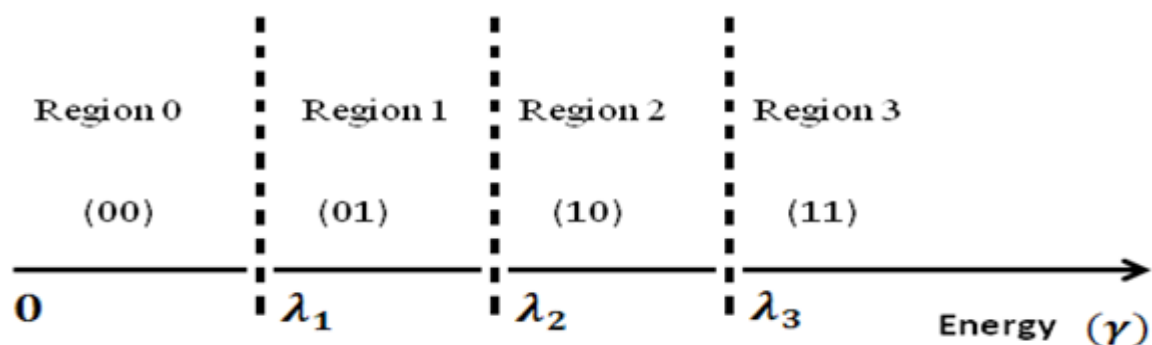

Figure 5-8: Regions of Observation Energy in the proposed approach scheme.

Figure 5-8 shows each CR node that observes the energy level in different areas. The CR node that observes an energy level in region 3 will send bits '11' to the decision node and the CR node that observes an energy level in region 0 does not send any information to the decision node.

The Neyman-Pearson criterion is used to determine thresholds of the proposed scheme. Every possible decision is hard-assigned; the Neyman-Pearson criterion state is powerful [67]. To decrease the probability of detection (Pd), we attempted to fix the probability value of false alarms (P_{fa}) by using the Neyman-Pearson criterion to determine the thresholds. The P_{fa} chosen for determining the second threshold is $\lambda_2 = 10^{-1}P_{fa}$; for the third threshold, $\lambda_3 = 2 \times 10^{-2}P_{fa}$, and for the first threshold, $\lambda_1 = P_{fa}$.

The thresholds shown in the example are given by;

$$\lambda_m = (m - 1) \times 10^{-(m-1)} \times P_{fa} \quad m = 2,3 \quad (5 - 10)$$

Where m is the threshold index,

Using the following equation allows a decision to be made as to whether the primary transmitted signal is present:

$$\sum_{k=1}^3 w_k N_k \geq \frac{M}{2} + 1 \quad (5 - 11)$$

where M is the number of cognitive radio nodes in the network, N_k is the number of observed values in area k , and w_k is the weight rate of area k . For example, the weight for area (7) is $w_3 = \frac{M}{2} + 1$, and for area (0) is $w_0 = 0$, therefore in the equation (5-11) the primary transmitted signal is confirmed as present if the weighted summation of is greater than $\frac{M}{2} + 1$. To determine the weights for the observed energy in the different regions, we use the following method:

- a) Region 3, weight is $w_3 = \frac{M}{2} + 1$: one of the CR nodes in the network observes energy in region 1 and, in the other regions, there is no observed signal energy.
- b) Region 2, weight is $w_2 = 2$: 50% of the CR nodes in the network observe energy in region 2 and, in the other regions, there is no observed signal energy.
- c) Region 1, weight is $w_1 = 1$: 100% of the CR nodes in the network observe energy in region 1 and, in the other regions, there is no observed signal energy.

In all of above, the primary transmitted signal is detected as present.

Where w_k and designing subject for thresholds. If the number of CR nodes in the network change, the observed energy in different regions can be used to calculate threshold values from the weight, for example 30% of the CR nodes in region 3 means that $w_3 = 3.333$.

Another set of coefficients can be used as shown in equation (5-12);

$$\lambda_m = 10^{-m} \times P_{fa} \quad m = 2,3 \quad (5 - 12)$$

The threshold index is m .

5.5 Simulation Results

Simulation results are given in the next section. The number of the averaged power spectral density (N_{avg}), signal to noise ratio (SNR), and the number of CR nodes for signal detection of the collaborative spectrum sensing of the proposed method are particularly considered. The detection performance for the proposed method is evaluated in comparison with the traditional fusion centre schemes and the two-bit hard combination method.

Figure 5-1 shows the simulation scenario. In this scenario, the CR nodes are randomly deployed around the region of interested the transmitted signals of primary users are determined in the spectral bands by detection by CR nodes.

The proposed, as in Figure 5-2, is summarized in the following stages:

- I. Three thresholds are determined by the decision node.
- II. For detecting within the spectrum bandwidth, all CR nodes apply coarse resolution spectrum sensing, except the decision node.
- III. The proposed scheme determines two-bit information (by applying the three thresholds) for each CR node in (II) and sends the data to the decision node.
- IV. The occupied spectrum bands are determined by the decision node and selects the CR nodes with strong two-bit detection, which apply fine resolution spectrum sensing on these spectrum bands.
- V. The CR nodes that apply fine resolution spectrum sensing, determine the primary transmitted frequency bands.
- VI. The report is sent to the decision node again to determine the occupied, vacant and weak channels on which to distribute the combination of CR nodes on the unoccupied channels, avoiding occupied and weak channels to prevent interference between the primary user and CR nodes communications.

Multi-resolution spectrum sensing (see Figure 5-3) determines the three thresholds; the stapes are composed of a low noise amplifier (LNA), Wavelet pulse generator (window generator), cosine function generator, multipliers, integrators and detector.

The input noise used (LNA + thermal noise) is given as follows:

For LNA, assuming $G = 40 \text{ dB}$ and $F = 5 \text{ dB}$, where G is gain value and F is noise figure value.

For the thermal noise:

$$N_{thermal} = G_k H_{Sys}^\circ B \quad (5 - 13)$$

Where G is the LNA gain, $k = 1.38 \times 10^{-23} \text{ J/K}$, the Boltzmann constant, H_{Sys}° is the system temperature, and B is the system bandwidth; the system temperature is given by,

$$H_{Sys}^\circ = H_{Ant}^\circ + H_{Line}^\circ + L_F H_{PreAmp}^\circ \quad (5 - 14)$$

where: H_{Ant}° is the antenna temperature, H_{Line}° is the temperature of the line, L_F is the line loss factor, and H_{PreAmp}° is the temperature of the preamplifier. Assume $290K^\circ$ is the antenna temperature and the line is lossless between the LNA and antenna, the equation in (5-14) becomes:

$$H_{Sys}^\circ = 290K^\circ + H_{PreAmp}^\circ \quad (5 - 15)$$

When $H_{PreAmp}^\circ = (F - 1) \times 290K^\circ$ using $F = 3.16$ than the temperature of the system is as intended $H_{Sys}^\circ = 916 K^\circ$. Then the thermal noise value is:

$$N_{Thermal-dB} = G_{dB} + K_{dB} + H_{Sys-dB}^\circ + B_{dB} \quad (5 - 16)$$

When $G_{dB} = 40$, $K_{dB} = -228.60$ and $H_{Sys-dB}^\circ = 29.62$, the window length is $0.1\mu s$ designed to determine the threshold and corresponds to 10 MHz, the system bandwidth, then the value of thermal noise is -88.98dB.

The rectangle window is used in the design and is defined as:

$$W[m] = \begin{cases} 1 & 0 \leq m \leq M_w \\ 0 & otherwise \end{cases} \quad (5 - 17)$$

Where;

window length = $M_w + 1$, pulse length of window $T_y = (M_w + 1) / f_s$, where f_s is the sampling frequency. T_y is adjustable to apply multi resolution spectrum sensing.

The parameter values are chosen as follows: $f_s = 1 \text{ GHz}$.

The frequency spectrum of the primary signal is assumed to be between:

$f_{start}=31$ MHz and $f_{stop} = 130$ MHz.

The outputs of the integrators are:

$$Z_I(r) = \frac{1}{T_y} \int_0^{T_y} [s(t)\{y(t)\cos(2\pi f_r t)\}]dt \quad \text{for } r = 0, \dots, R \quad (5 - 18)$$

$$Z_Q(r) = \frac{1}{T_y} \int_0^{T_y} [s(t)\{y(t)\sin(2\pi f_r t)\}]dt \quad \text{for } r = 0, \dots, R \quad (5 - 19)$$

When the rectangular window pulse has length $T_y = y(t)$,

$f_r = (31 \times 10^6 + r f_{sweep})$ With

$R = \text{around}[(130 \times 10^6 \text{ Hz} - 31 \times 10^6 \text{ Hz})/f_{sweep}]$

$f_{sweep} = 5$ MHz and $T_y = 0.1 \mu s$ are chosen for determination of the three thresholds.

When the input is a Gaussian random variable, the detector outputs a Rayleigh distributed variable, and is given by ;

$$P_r = \sqrt{Z_I^2(r) + Z_Q^2(r)} \quad (5 - 20)$$

Where P_r is the power spectral density and is calculated by averaging.

To determine the thresholds, noise-only distribution inputs to the envelope detector are assumed to be Gaussian with zero mean and variance σ^2 , the Rayleigh distribution with the range parameter σ is the output of the envelope detector. The regions under the probability density function of the output distribution are the values of the thresholds. In other words, to determine the thresholds the regions under the output distribution for different values of P_{fa} are calculated.

Then all CR nodes are given the values of the thresholds, after which all CR nodes apply coarse resolution by passing the RF signal through shadowing and the multipath fading channel for rapidly sensing the spectrum. The sensing parameters are selected as: $f_{sweep} = 2$ MHz and $T_y = 2 \mu s$, $f_s = 1$ GHz, bandwidth = 0.5 MHz, thermal noise for coarse resolution sensing = -101.99 dB.

The primary transmitter parameter is assumed to be: 64QAM modulation with carrier frequency = 105 MHz, determined in the local area with CR nodes. After applying coarse resolution sensing, the results are compared with the three thresholds and the two-

bit values of the proposed approach are determined for each value of frequency at every node and the bit information is sent to the decision node. Then, the two-bit data from each stage (of the proposed approach) is collected from all nodes and the decision node decides if the primary signals are present or absent.

The next stage implements fine resolution sensing; the aim of which is to determine the frequency band of the primary signals. As mentioned earlier the difference between coarse and fine resolution are the values of f_{sweep} and T_y , which are chosen for fine resolution as $T_y = 4 \mu s$ and $f_{sweep} = 500 \text{ kHz}$. The fine resolution is applied by the nodes which are selected by the decision node, so that the CR nodes sense the highest energy in these frequency bands.

MATLAB[®] simulation code was created to implement the MRSS method and the modified two-bit hard combination scheme as the sensing mode for developing our proposed model. In particular, the effects of the number of CR nodes, the number of power spectrum density averaged (N_{avg}) and SNR on detection performance are evaluated for the collaborative spectrum sensing of the proposed method.

The SNR given by:

$$SNR_{dB} = 10 \log_{10} \left(\frac{\text{Power of Signal}}{\text{Power of Noise}} \right) \quad (5 - 21)$$

Throughout this chapter simulation results show the implemented probability of detection as a performance measure of detection; in every case simulations were run 1000 times. The simulation parameters used are a Gaussian standard deviation $\sigma=10$, and probability of false alarm as $P_{fa} = 0.05$. All simulations used 64QAM modulation with 105 MHz carrier frequency as the primary signal transmitter.

The probability of miss-detection (PMD) and probability of detection (PD) are defined as:

$$PMD = 1 - \frac{N_D \text{ of Primary Transmitter}}{N_{smu}} \quad (5 - 22)$$

and;

$$PD + PMD = 1$$

where N_D is the Number of Detections and N_{smu} is the Simulation Runs Number.

- To investigate the effects of the power spectrum density averaged (N_{avrg}) on the probability of detection.

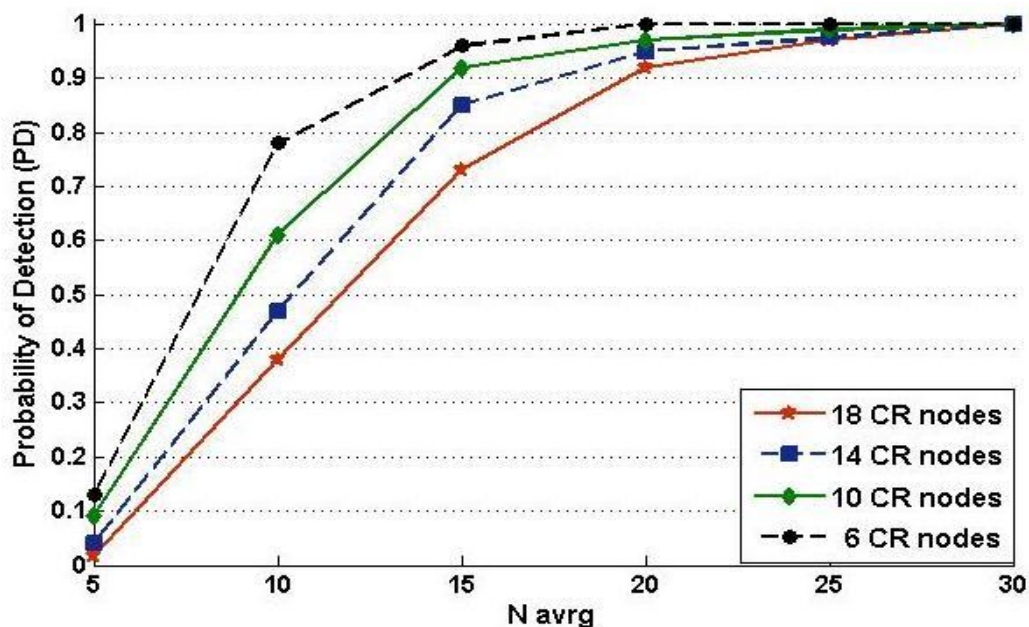

Figure 5-9: Probability of Detection (PD) vs. N_{avrg} with Number of CR nodes.

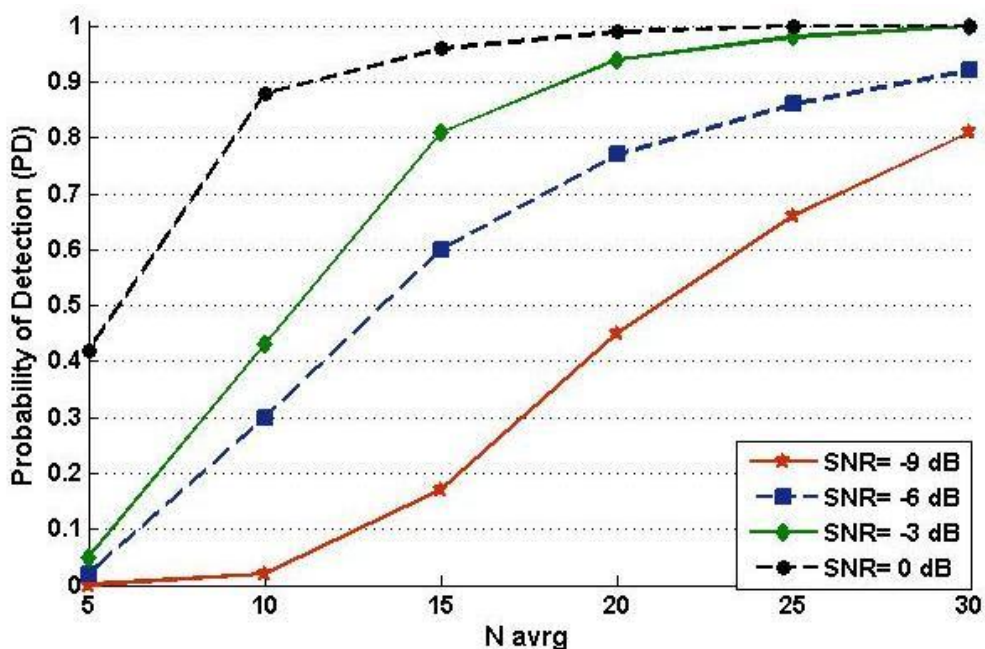

Figure 5-10: Probability of Detection (PD) vs. N_{avrg} with Different values of SNR.

Figure 5.9 shows the probability of detection versus the effect of power spectrum density averaged (N_{avrg}) in collaborative spectrum sensing at SNR = -5 dB; the performance for different numbers of CR nodes can be seen. Figure 5-10 shows the

probability of detection vs. Power spectrum density Averaged for different values of SNR, with the number of CR nodes fixed as 12 in the collaborative spectrum detection scheme. Note from both figures that the probability of detection increases when the numbers of PSD averaged increases.

Figure 5-9 shows that 18, 14 or 10 CR nodes perform the worst detection of the primary transmitter signal than six CR nodes when the (N_{avg}) is less than twenty. This is due to the positions of the CR nodes positions and the applied decision measure. Figure 5-10 indicates that the probability of detection is improved when N_{avg} increases and that the probability of detection degrades with particular N_{avg} for low SNR.

- To investigate the probability of detection effects with different numbers of CR nodes. In particular, CR nodes are assumed to fail in CR networks due to limited battery energy, or environmental effects. For that condition the number of CR nodes sharing the collaborative spectrum sensing can change.

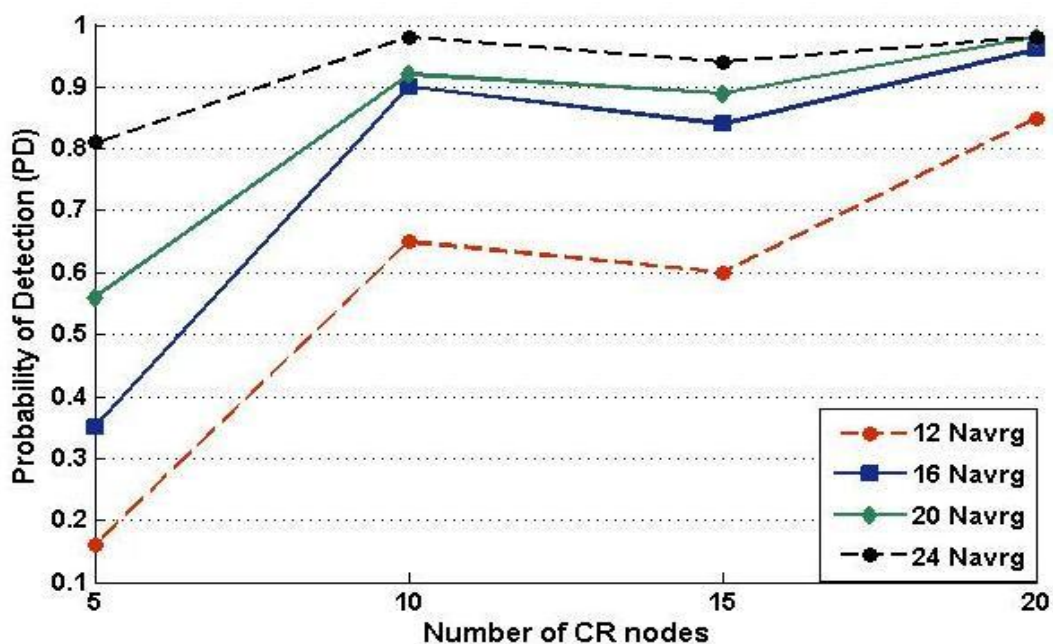

Figure 5-11: Probability of Detection (PD) vs. Number of CR nodes with Different N_{avg} .

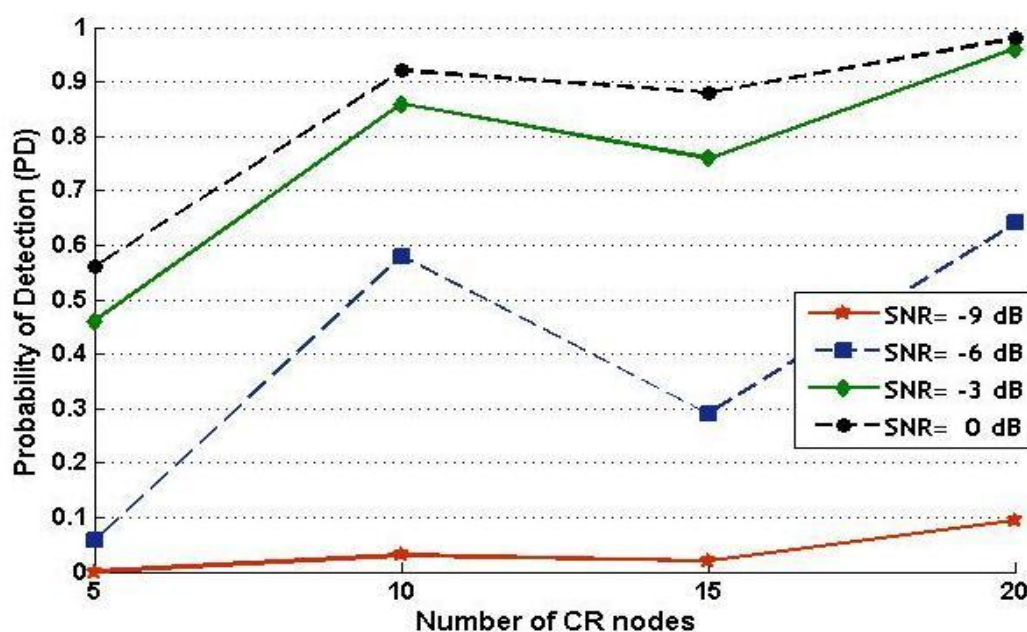

Figure 5-12: Probability of Detection (PD) vs. Number of CR nodes with Different values of SNR.

Figure 5-11 shows, the probability of detection vs. number of cooperating CR nodes for different power spectrum sensing averaged numbers at an SNR of -5dB. Figure 5-12 shows the probability of detection effected by different numbers of cooperating CR nodes when $N_{avg} = 14$ and at different values of SNR.

The plot of $(N_{avg}) = 12$ in Figure 5-11 shows that if there are 20 CR nodes sharing in the collaborative spectrum sensing, the greatest detection performance is achieved. The other greater probability of detection value occurs when 10 CR nodes are shared. Changing probability of detection values are achieved for other numbers of CR nodes in this graph. These results are due to the position of the CR nodes and the applied decision measure, leading to the conclusion that the position of nodes 20 and 10 are the closest nodes to the primary transmitter. Furthermore, Figure 5-12 shows that the probability of detection increases with increasing (N_{avg}) , which may be seen from the different plots since higher N_{avg} plots are more smooth than the plot of $N_{avg} = 12$.

In Figure 5-11 we can see, for the number of CR nodes, lower SNR is achieved for a minimum probability of detection. Also in Figure 5-12 we can see, that the different position of nodes can affect the smoothness of the plot with different values of SNR.

- To investigate the probability of detection at different SNR: Figure 5-13 illustrates the effect of signal-to- noise ratio on the probability of detection for four different N_{avg} with 12 CR nodes sharing in collaborative spectrum

sensing. As seen in Figure 5-14 there are different plots of probability of detection versus different SNR for four different numbers of cooperating CR nodes when $N_{avg} = 14$.

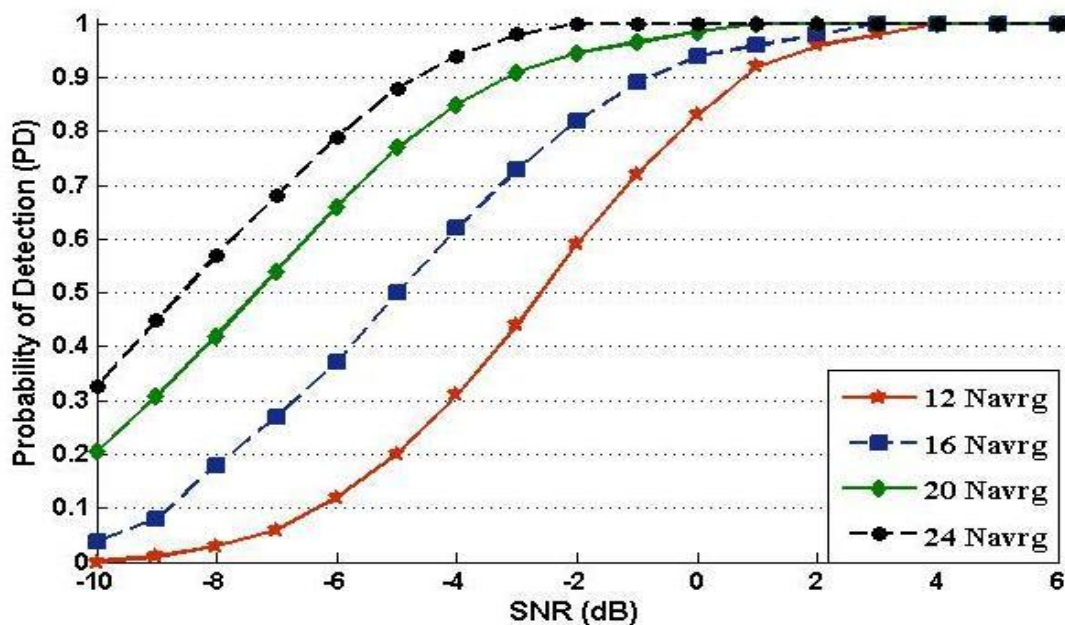

Figure 5-13: Probability of Detection (PD) vs. SNR (dB) with Different N_{avg} .

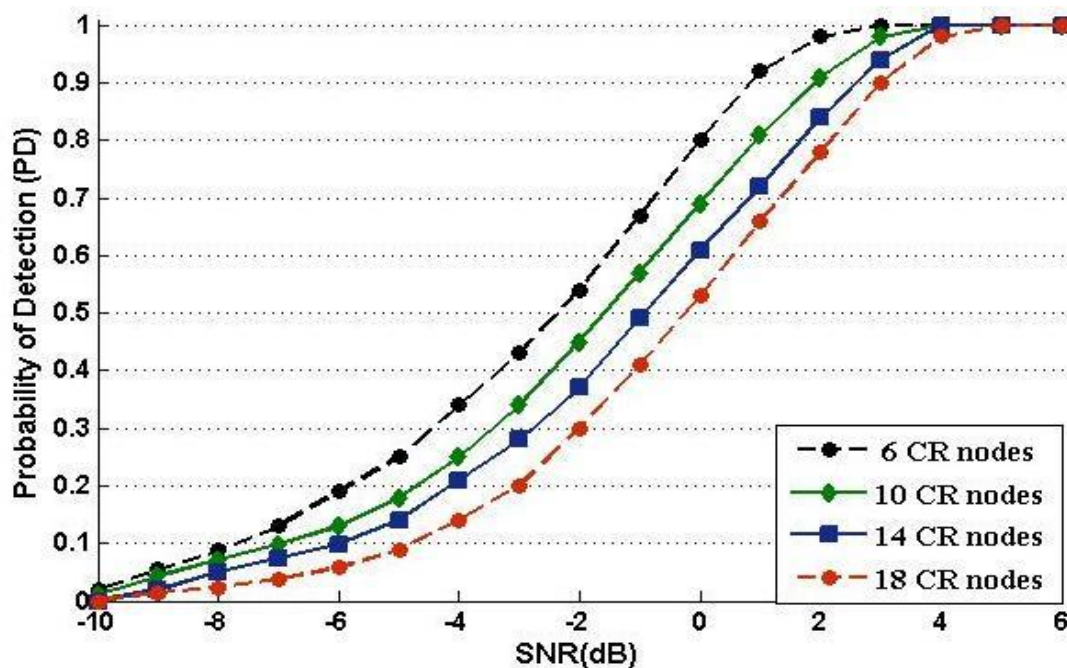

Figure 5-14: Probability of Detection (PD) vs. SNR (dB) with Number of CR nodes.

Both figures show the probability of detection is improved with high SNR.

As seen in Figure 5-13 a higher probability of detection is achieved with increasing values of N_{avg} .

As previously mentioned, the applied decision measure and the position of the CR nodes may affect performance of detection and this may cause a reduction in the probability of detection with increasing number of CR nodes. This problem can be seen in Figure 5-14, the reduced probability of detection is compared for 18, 14, 10 and 6 CR nodes.

- In particular, our proposed model is compared (detection, miss-detection and false alarm performance) with simulated other traditional fusion (combination) schemes such as, the OR rule, Majority rule and two bit hard combination.

It is assumed, for comparison between schemes, that in the region there are four CR nodes sharing in the collaborative spectrum sensing, the number of power spectrum density (N_{avg}) is 14, the probability of false alarm $P_{fa}=0.05$, and the Gaussian variable standard deviation in the channel model σ is 10. All results are presented after 1000 simulation runs.

Figures 5-15 and 5-16 show the probability of detection and probability of miss-detection versus SNR for four methods. It indicates that when the SNR is between -10 dB and 6 dB, the proposed scheme has a higher probability of detection and lower probability of miss-detection compared with the traditional two-bit hard combination scheme. In other words, the traditional decision fusion using the OR-rule has greater detection and lower miss-detection than other schemes for SNR less than 0 dB, because of clearly detecting the presence of the primary signal by sensing the energy of primary user signal, which is sufficiently above the threshold using only one CR node in the OR rule. Therefore, this gives higher performance of detection with low miss-detection for SNR less than 0 dB to the traditional decision fusion using the OR-rule. Additionally, the two-bit hard combination has a low detection performance for SNR compared with the proposed approach with high miss-detection probability, because of applying two logic bits of sensing information.

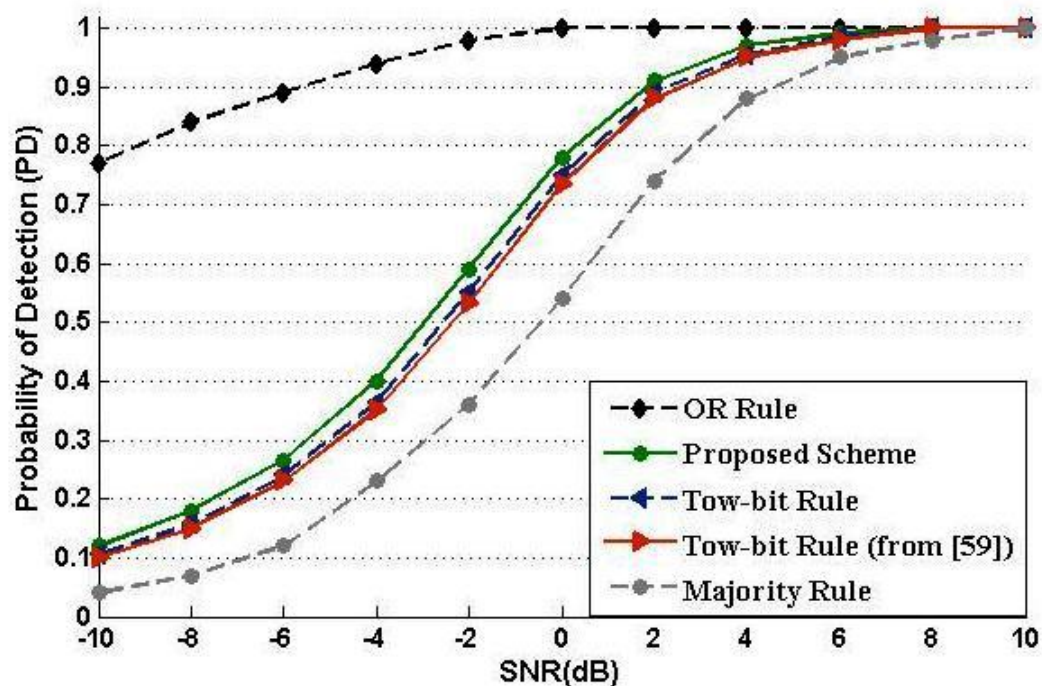

Figure 5-15: Probability of Detection (PD) vs. SNR (dB) with Different Schemes.

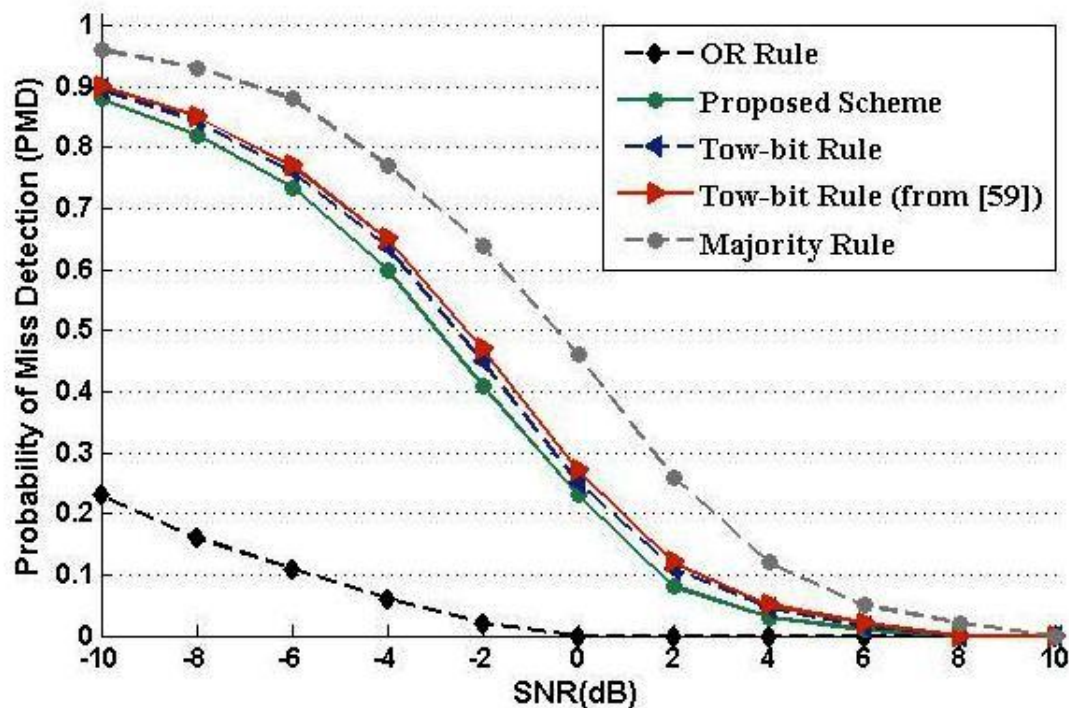

Figure 5-16: Probability of Miss Detection (PMD) vs. SNR (dB) with Different Schemes.

Table 4.1 below shows the number of channels given false alarm with various SNR; values are calculated from simulation for different decision schemes by dividing the number of sensing frequencies in the band that are giving false alarms during simulation runs on the

number of scanning channels. In the table, it can be seen that the proposed method gives robust performance of false alarm compared to the three decision fusion schemes. In particular, the capability of only one CR node detecting the presence of the primary user signal is the reason that the traditional decision fusion scheme using the OR-rule exhibits the worst performance of false alarms. In fact, using the OR-rule as the traditional decision fusion scheme to make final decision, from the table below at SNR =5 dB, 0.78 of the examined frequencies in coarse resolution sensing will be sent to the fine resolution stage profusely compared with the proposed approach method, which is just 0.19 of the examined frequency channels can be sent to the fine resolution (saving time and energy).

Table 5-1: False Alarm Channels with SNR (dB) for Different Schemes.

SNR		-5 dB	0 dB	5 dB
OR Rule	(number of channels given false alarm)	0.028	0.31	0.78
Majority Rule	(number of channels given false alarm)	0.018	0.24	0.51
Two-Bit Rule	(number of channels given false alarm)	0.04	0.19	0.31
Proposed approach	(number of channels given false alarm)	0.03	0.17	0.19

The following conclusions may be made when analyzing figures 5-15, 5-16 and Table (5-1). The false alarm detection of the channel frequencies in coarse resolution sensing used in CR networks cause some of the nodes to apply fine resolution sensing unnecessarily. This leads to wasting limited battery energy for the advanced calculation and communications between the CR node and the decision node. The implementation of the proposed scheme, as mentioned earlier in simulation result, is that the performance of detection can be improved by increasing the number of power spectrum density averaged (N_{avg}). Therefore

this needs more computation when increasing the N_{avg} ; on the other hand, this computation is less costly compared to communication overhead, which requires extra battery power in CR networks. Therefore, even the traditional hard combination (OR rule) presents better sensing performance for circumstances where the SNR is less than 6 dB; the proposed method is more efficient for cognitive radio networks.

5.6 Cluster-based Cooperative Wideband Spectrum Sensing

The second part of our work presents the cluster based cooperative spectrum sensing with soft combination EGC scheme and the proposed modify two-bit hard combination method in cognitive radio systems. The sensing performance is improved by grouping all the secondary users, as in section 5.2, into a few clusters and selecting one user in each cluster as the decision node to report result-sensing information to the fusion centre. Further, the soft combination EGC and modify two-bit hard combination methods are established to improve detection performance.

With the cooperative spectrum sensing proposed, sensing performance can be severely degraded when local observations report to a common receiver through fading channels. In order to overcome this problem Sun et al. has proposed a cluster-based cooperative sensing method. In this method, few SUs with the same SNR are formed into a cluster, selecting the most favourable user to be the cluster header that collects local sensing information from all SUs to make the cluster decision and then report to the common receiver. This method substantially improves the sensing performance compared with the traditional method. Additionally, for making the global decision the authors have considered the OR-rule with only one threshold.

Another scheme suggested in [57], investigates the soft hard combination and clustering schemes to propose a novel cooperative spectrum-sensing scheme based on clustering and softened hard combination method. In this method, the authors employ both the soft combination method and two bit hard combination schemes and a modification based on SNR estimation. This scheme improves the sensing performance compared with the traditional method and achieves good tradeoffs. In [56], the authors propose a novel cluster-based cooperative spectrum sensing with double adaptive thresholds and modify two-bit scheme local decision in cognitive radio. In this method, they implement the energy detection scheme with double adaptive energy thresholds and modify two-bit quantization. The authors study adaptive energy threshold as the variable energy thresholds that rely on the optimal energy threshold of one threshold case and the received energy. In actuality, this method improves the sensing performance compared with traditional schemes and achieves good differentiations.

In this chapter, the cluster-based cooperative spectrum sensing with soft hard combination in cognitive radio systems is proposed by combination clustering and softened hard combination for improving the sensing performance. In our proposed scheme, we improve the detection performance by clustering and utilize both the soft combination method and the proposed scheme.

As previously mentioned, in soft combination method, cognitive radio nodes forward their observation information to the fusion centre directly without making any decision. The fusion centre decides upon the presence of the primary transmitter signal through the use of this information. It is confirmed that soft combination methods have better performance improvement over traditional hard combination, such as Equal Gain Combination (EGC) [59].

5.6.1 Description of Scenario Model

In this model, the position of all CR users is close together. Therefore, we assume that all CR users in the same cluster have the same channel with primary user and different clusters have different channels with the primary user (SNR, γ_i).

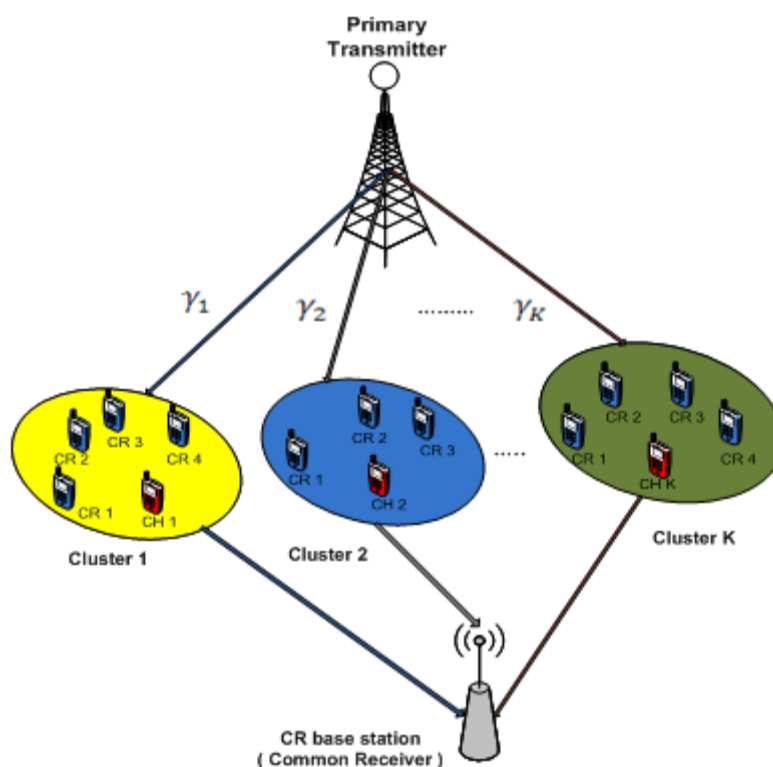

Figure 5-17: Scenario Cluster Model.

The system structure of the proposed method is shown in Figure 5-17. Initially, all the secondary users are assumed to be divided into K clusters by upper layer protocols with some distributed clustering algorithms. Then, any secondary user can select as cluster head CH (decision node) according to the position of cluster. Subsequently, collaborative spectrum sensing is performed by the following stages.

- A. Each SU in each cluster applies local spectrum sensing and sends the local observation information to the CH.
- B. Each CH collects the sensing information from all CR users in the same cluster and makes a cluster decision; this is then forwarded as the decision information to the common receiver.
- C. The final global decision is made by using fusion rule in the common receiver.

In this work, each SU performs local sensing by using the Multi-Resolution Spectrum Sensing (MRSS) technique. The approved combination method at the CHs is soft combination scheme (EGC) and modify two-bit hard combination method is used to make the global decision. Both schemes are described briefly in the following sections.

5.6.1.1 Local Spectrum Sensing

As described earlier, spectrum sensing techniques can be classified into three types: matched filter, energy detection and cyclostationary detection. A variety of detection schemes have been proposed in [4]. For example, the matched filter is optimal, but requires the prior knowledge of the primary user. Energy detection is suboptimal, but simple to implement. Cyclostationary detection can detect primary signals under very low SNR, but still needs some prior knowledge of the primary system. In comparison, energy detection does not require any prior information of primary signals and has reduced complexity than that of the other two methods. Therefore, in this work, we consider the MRSS (a kind of energy detection) technique, described earlier in this chapter.

5.6.1.2 Local Sensing Decision (Equal Gain Combination Scheme)

In the soft combination, different CR users in the same cluster apply MRSS and the observed values are summed with weights; the weighted summation is given by:

$$X_i = \sum_{j=1}^N w_{i,j} X_{i,j} \quad (5 - 23)$$

$$\text{Issue to; } \sum_{j=1}^N w_{i,j}^2 = 1, \quad 0 < w_{i,j} < 1$$

where $w_{i,j}$ weight coefficient to the j^{th} , CR user in i^{th} cluster, $X_{i,j}$ the test statistic and N is the number of CR users in i^{th} cluster. Similar to multiple receive antennas systems, the equal gain combination (EGC) is given by;

$$w_{EGC_{i,j}} = 1/\sqrt{N}, \quad 1 \leq j \leq N \quad (5 - 24)$$

Suppose $X_{i,j}$ and $w_{i,j}$ are individual values for different CR users, then X_i follows a Gaussian distribution,

$$X_i = \begin{cases} N\left(\sqrt{N}, \frac{2}{M}\right) & H_0 \\ N\left(\sum_{j=1}^N \frac{1}{\sqrt{N}}(1+\gamma), \frac{2}{MN} \sum_{j=1}^N (1+\gamma)^2\right) & H_1 \end{cases} \quad (5 - 25)$$

where H_1 and H_0 represent that primary signal as present or absent, γ the SNR of the CR user, and M the number of samples of the CR user.

In particular, the EGC method does not need any channel condition information of CR users compared with other schemes, such as maximal ratio combination (MRC) [59], therefore, in this paper, the EGC method is adopted.

5.6.1.3 Global Sensing Decision (proposed approach scheme)

The proposed approach (modify two-bit hard combination method used in the present scheme – collaborative Wideband Spectrum Sensing in Cognitive Radio Networks) is described in chapter 5. It has been implemented in this work to make global decisions.

5.6.2 Summary of the Proposed Method

Currently, the proposal method is summarised as follows: locate $N * K$ cooperative users of CR network, the cluster number is K and the number of cognitive radio users in each cluster is N , each cluster has same number of CR nodes, user with large SNR choose as CH in each cluster and the channel between any two users in the same cluster is perfect since they are close to each other; the spectrum sensing is implemented as follows:

1. Each CR user j in cluster i applies local coarse resolution spectrum sensing and forwards their observation $x_{i,j}$ where $i = 1,2 \dots K$ & $j = 1,2, \dots N$ to its CH.
2. Firstly, the CH collects those local observations in the same cluster and implements the EGC soft combination, $x_i = \frac{1}{\sqrt{N}} \sum_{j=1}^N x_{i,j}$. After that X_i approximates the Gaussian distribution as given in equation (5-24). Secondly, according to the distribution function, the thresholds T1,T2 and T3 are determined by equation (5-10) which is explained in section (5.2.2-D). Thirdly, the CHs report the two-bit (proposed approach) information results to the common receiver.
3. The two-bit information results from the CHs are collected at the common receiver and apply equation (5-11) to make the final decision whether the primary signal is present or absent.

The CH with strong two-bit detection is selected by the common receiver and all CR users in this CH can apply fine resolution to determine the occupied spectrum bands of the primary user and all this information can be used to avoid interference with the primary user.

5.6.3 Cluster Model Simulation and Results

The simulation results obtained show the performance gain of the proposed method in both the cluster header and the common receiver. The simulation stage is as follows. In the simulation, we consider four clusters with five CR nodes in each cluster in the system in which there are 20 CR nodes without clustering. For local energy detection, 1000 sample value are used and we assume that all CR nodes have an SNR within the range of [-22 to -12] dB. The traditional cooperative spectrum sensing schemes, such as OR-rule and Majority-rule, are also simulated for comparison and the results of the proposed approached without clustering are also used to compare with the proposed model's performance.

Figures 5-18, 5-19 and 5-20 show the cluster performance for the probability of detection (PD), probability of false alarm (PFA) and probability of miss-detection (PM) according to the proposed combining methods in the common receiver versus the different traditional methods and modify two-bit hard combination method without clustering; the proposed combining methods shows an improvement with high PD and low PFA, PM an average SNR of -16 dB. On the other hand, the values of the modify two-bit hard combination method without clustering show better PFA compared with proposed method.

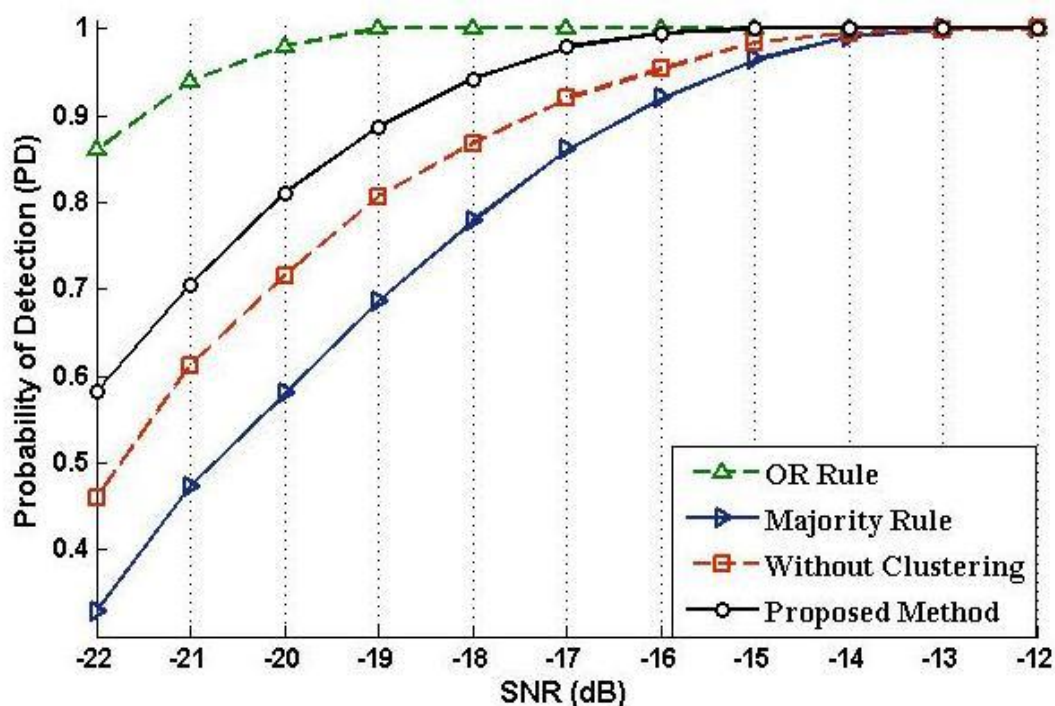

Figure 5-18: Probability of Detection vs. SNR at the Common Receiver.

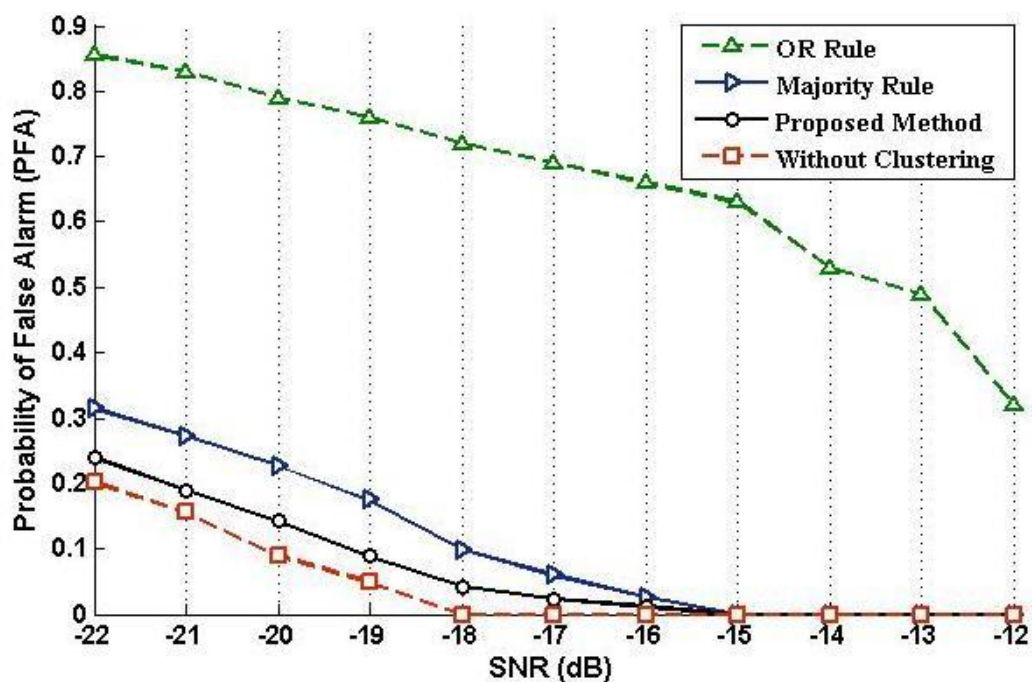

Figure 5-19: Probability of False Alarm vs. SNR at the Common Receiver.

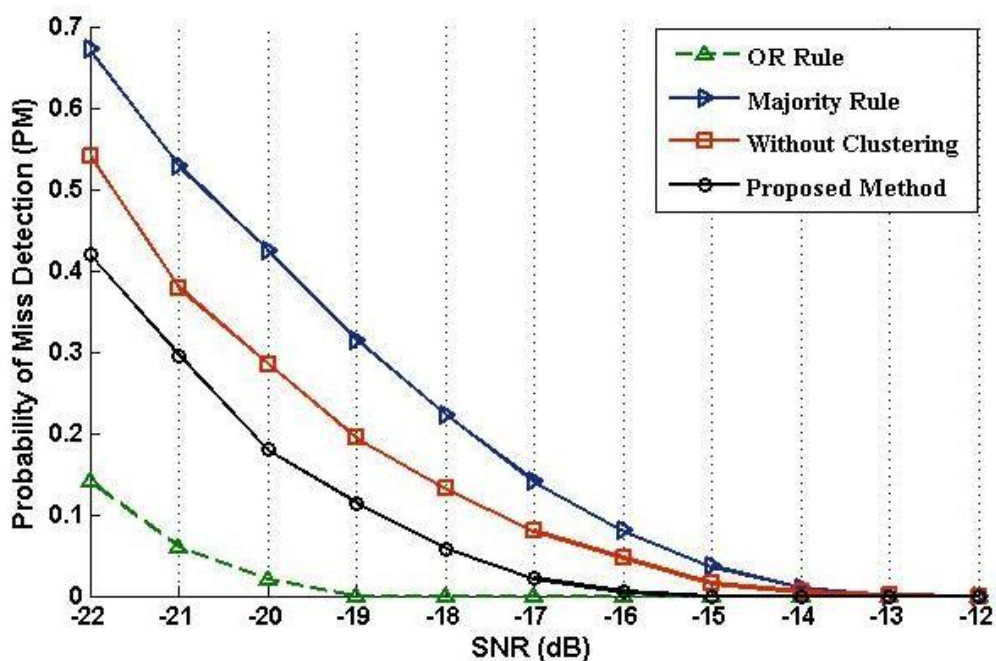

Figure 5-20: Probability of Miss Detection vs. SNR at the Common Receiver.

The plots in Figure 5-21 demonstrates that the proposed method with the lowest value of error probability PE has improving sensing performance compared with the

traditional fusion methods in the common receiver and modify two-bit hard combination method without clustering.

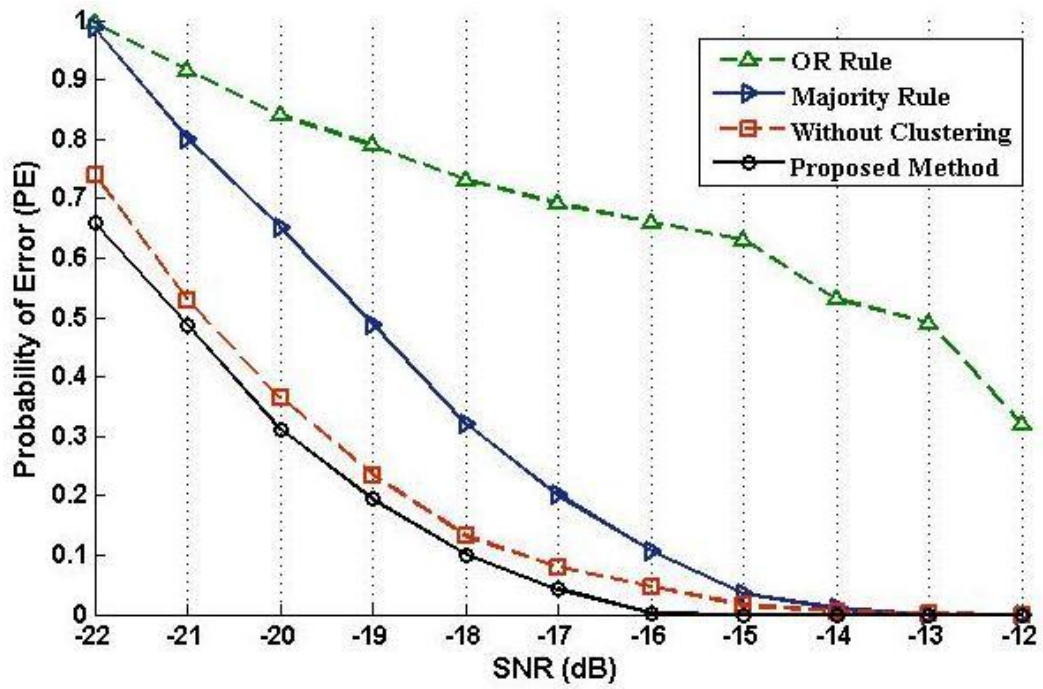

Figure 5-21: Probability of Error vs. SNR at the Common Receiver.

5.7 Summary

We can summarize the implementation of the proposed approach of both scenarios:

1. The proposed cognitive radio network based collaborative spectrum sensing is efficient for cognitive radio networks as long as it senses spectrum band energy efficiently accounting for shadowing, fading and noise. The energy efficient approaches from the usage of MRSS and the proposed approach (modify two-bit hard combination). With MRSS, refined exhaustive sensing on vacant bands is avoided, and less overhead in cooperation with soft combination is provided by modify two-bit hard combination.
2. The simulation results of the implemented collaborative spectrum sensing of the proposed method shows that the position of the CR nodes that share in the sensing and practical decision affect the performance of detection. The proposed approach (modify two-bit hard combination method) reduces the probability of false alarm compared to the traditional hard fusion methods. A little extra cost by increasing the numbers of PSD averaged can be improve the detection performance of the modify two-bit hard combination scheme.
3. The advantages of the proposed method, cluster-based cooperative spectrum sensing with softened hard combination in cognitive radio system, have been proved by simulation, which shows that the proposed sensing method can achieve better performance in both the cluster header and common receiver.

CHAPTER 6

Conclusions and Future Work

6.1 Conclusion

The aim of this thesis was to resolve some of the challenging issues in cognitive radio applications and other wireless technologies. This work introduced the implementation of spectrum sensing methods in cognitive radio systems by deriving decision rules for detecting various types of primary user signals to design sensing strategies and investigate different algorithms for sensing the transmitter primary signals and to evaluate sensing schemes in term of performance, complexity, and energy efficiency. Additionally, the thesis introduces a new strategy for detecting the imitation transition from cognitive radios.

The thesis also proposes performances of spectrum sensing methods for UWB-CR system for detecting primary signal in AWGN and fading channels.

Finally, the thesis proposes two models of cooperative wideband spectrum sensing in cognitive radio aimed at improving the sensing performance, reducing the time sensing delay, efficiency of energy and reducing the reporting error.

in the first contribution, Our strategy aim is to introduce hiding secondary users by using spectrum sensing function in cognitive radios applications at the base station of primary license technology to detect, identify the primary and secondary users using spectrum bands. For some reasons Cognitive radios are hiding themselves by using the same primary frequencies, Our MATLAB[®] simulation processed two different scenarios with two signals modulation for each scenario as primary and secondary users transition on the same channel, under free and low SNR. Transition of Primary and secondary signals were clearly exhibits that detection and identification of different modulation signals even under low of SNR. Moreover, the benefits of design are avoiding to the interference among users using same channel, track the primary and secondary users. Additionally, the presented

modification will alert managing entities for the future networks on any uncharted transition whenever it occurs. The suggested model will be required to assure the reliability of the charging system.

this in the second contribution proposes spectrum sensing methods for UWB-CR system for detecting primary signal in AWGN and fading channels. In this work, various sensing detection methods in UWB-CR system are considered. The implementation of the different detectors shows that the matched filter detection method is a suitable for detecting signals through UWB-Cognitive Radio networks under different fading channels particularly all required of information for sensing primary users are known for cognitive radio nodes. However, the architecture of the UWB signals is known for UWB system but the occupancy level and band location unknown. Therefore, UWB-CR techniques are required to estimate or measure exact location of primary users at nearby cognitive radios.

in the last contribution, cooperative Wideband spectrum sensing in cognitive radio users is proposed as first model. Developing multi-bit hard combination techniques was proposed for cooperation of the cognitive radio nodes for reliable final sensing decision by increase probability of detection and reduces probability of false alarm. The probability of detection of proposal mode is investigated with different averaging spectrum density, various number of cognitive radio and different values of SNR. On the other hand, the proposed model lead to an energy efficient manner by providing flexibility to fading and shadowing. Energy efficiency comes from; redundant exhaustive sensing on unoccupied bands is avoided by using multi resolution spectrum sensing method. The suggested proposal method is better to the conventional hard combination methods in false alarm decrease.

In the second proposal model, cluster-based cooperative wideband spectrum sensing objecting at improve performance of CR system. The cluster method is employed to increasing the sensing performance and decreases the reporting errors implementation in cognitive radio network. Moreover, the soft combination (Equal Gain Combination Method) and multi-bit hard combination scheme are implemented to improve the detection performance and reduce transmitting over head. The analysis results show that the proposal sensing method can achieve better performance in the common receiver than that of traditional spectrum sensing fusion methods and proposal method without clustering.

6.2 Future Work

▪ **Performance of Spectrum Sensing Methods in Cognitive Radio Over Fibre Technology**

To get benefit from performance of spectrum sensing methods, with other technologies,

1. The same strategy can be used in cognitive radio over fibre techniques (CRoF).
2. The idea explores some of the improvements that radio over fibre technology can bring to wireless networks when combined with cognitive radio techniques (spectrum sensing function).

▪ **Implementation of Spectrum Sensing Methods for UWB-Cognitive Radio System**

There are some issues which if used can further add to the performance improvement of systems:

1. Comparison implementations of spectrum sensing methods under such circumstances for cognitive UWB-OFDM systems.
2. Proposed cooperative detection of transmitter signal in UWB-CR systems.

▪ **Cooperative Wideband Spectrum Sensing in Cognitive Radio Networks**

The proposed model, although proven to provide satisfactory results, has some issues which if addressed can further add to the improvement of the proposed research.

1. Different fading channel effects can be used and their effect on the implementation of the proposed method could be studied.
2. Another approach would be to study different scenarios (e.g., different detection methods) of how secondary users can detect primary users rather than the detection method introduced in the chapter.
3. Another improvement that could be made, in weight proposal fusion method, resolve best values for the profit of cognitive radio nodes required in a known region to declare the attendance of the primary signal transmitter could be determined using detection theory.

List of Publications

Publish paper

1. A. Al-Dulaimi, N. Radhi and H.S. Al-Raweshidy, "Cyclostationary Detection of Undefined Secondary Users," IEEE 3rd International Conference on Next Generation Mobile Applications, Services and Technologies, pp. 230-233, September 2009.
2. N. Radhi and H.S. AL-Raweshidy, "Performance of Spectrum Sensing Methods for UWB-CR System for Detecting Primary Signal in AWGN and fading channel," the 26th International Technical Conference on circuits/system, Computers and Communications ITC-CSCC 2011, pp. 1213-1216, June 2011.
3. N. Radhi and H.S. AL-Raweshidy, "Reputation-Based Non-Cooperative Auction Game Competitive for Spectrum Sensing in Cognitive Radio Networks," the 12th Annual PostGraduate Symposium on the Convergence of Telecommunications, Networking and Broadcasting PGNET'11, pp. 89-94, June 2011.
4. N. Radhi, K. Aziz, Sofian Hamad and H.S. Al-Raweshidy, "Estimate Primary user Localization using Cognitive Radio Networks," IEEE 7th International Conference on Innovations in Information Technology, pp. 381-385, April 2011.
5. S. Hamad, H. Noureddine, N. Radhi, I. Shah and H. S. Al-Raweshidy, "Efficient Flooding Based on Node Position for Mobile Ad hoc Network," IEEE 7th International Conference on Innovations in Information Technology, pp. 162-166, April 2011.
6. N. Radhi and H.S. Al-Raweshidy, "Cyclostationary Detection in Spectrum Pooling System of Undefined Secondary Users," 7th International Conference on Wireless and Mobile Communications (ICWMC 11), pp. 266-270, June 2011.
7. S. Hamad, N. Radhi and H.S. Al-Raweshidy, "Candidate Neighbour to Rebroadcast RREQ for Efficient Flooding in Mobile Ad Hoc Network," IEEE Wireless Advanced Conference (WiAd), pp 1-5, June 2011.
8. N. Radhi and H.S. AL-Raweshidy, "Primary Signal Transmitter Localization using Cognitive Radio Networks," IEEE Conference NGMAST'11, pp. 1-5, September 2011.

9. N. Radhi and H.S. AL-Raweshidy," Implementation of Spectrum Sensing Methods for UWB-Cognitive Radio System, IEEE Fifth International Conference on Next Generation Mobil Application, pp. 1-6, September 2011.
10. S. R. Abdollahi, H.S. Al-Raweshidy, Nazar Radhi and R. Nilavalan "Non-Uniform Wavelength Allocation in All-Photonic Digitized-Radio over Fibre Access Network", IEEE 14th International Symposium on Wireless Personal Multimedia WPMC'11, pp. 1-4, October 2011.
11. N. Radhi and H.S. AL-Raweshidy," Performance of Spectrum Sensing Methods for UWB-CR System for Detecting Primary Signal in AWGN and fading channel," Journal of Communication and Computer (JCC) USA, vol. 8, No. 5, pp. 1-6, November 2011.

Papers currently under-review/ in press:

1. N. Radhi and H.S. AL-Raweshidy," Cluster-based Cooperative Spectrum Sensing with Softened Hard Combination in Cognitive Radio Systems", Submitted to IEEE Global Communications Conference GLOBECOM (GC'11).(UNDER REVIEW)
2. N. Radhi and H.S. AL-Raweshidy," Implementation of Spectrum Sensing Methods for UWB-CR System", Submitted to IEEE communications Letter, 2011. (UNDER REVIEW)
3. N. Radhi and H.S. AL-Raweshidy, "Spectrum sensing and Localization using Cognitive Radio Networks", Submitted to IEEE Vehicular Technology Magazine, 2011. (UNDER REVIEW)
4. N. Radhi and H.S. AL-Raweshidy," Cluster and Cooperative Spectrum Sensing with multi-bit Hard Combination in Cognitive Radio Networks", Submitted to IET Journal in communications, 2011. (UNDER REVIEW)

References

- [1] FCC, "Spectrum policy task force report," Tech. Rep. 02-135, Federal Communications Commission, November 2002, Washington, USA, http://hraunfoss.fcc.gov/edocs_public/attachmatch/DOC-228542A1.pdf.
- [2] S. Haykin, "Cognitive radio: brain-empowered wireless communications," *IEEE Journal on Selected Areas in Communications*, vol. 23, No. 2, pp. 201–220, February 2005.
- [3] E. Larsson and M. Skoglund, "Cognitive radio in a frequency-planned environment: some basic limits," *IEEE Transactions on Wireless Communications*, vol. 7, No. 12, pp. 4800–4806, December 2008.
- [4] D. Cabric, S. M. Mishara and R. W. Brodersen, "Implementation Issues in Spectrum Sensing for Cognitive Radios," *Proceedings of Asilomar Conference on Signals, Systems and Computers*, Pacific Grove, California, USA, pp. 772-776, November 2004.
- [5] Q. Zhang, B. J. Kokkeler and J.M. Smit, "An efficient multi-resolution spectrum sensing method for cognitive radio," *Proc. Of Third International Conference on Communication and Networking in Hangzhou, China*, pp. 1226-1229, August 2008.
- [6] J. Mitola and Q. Maguire, Jr., "Cognitive radio: making software radios more personal," *IEEE Personal Communications Magazine*, vol. 6, No. 4, pp. 13-18, August 1999.
- [7] Federal Communications Commission, Spectrum Policy Task Force, Rep. ETDocket, Washington, USA, No.02, pp. 132-135, November 2002.
- [8] C. T. Chou, N. S. Shankar, H. Kim and K. Shin, "What and How Much to Gain by Spectral Agility," *IEEE Journal on Selected Area in Communication*, vol. 25, No. 3, pp. 576-588, April 2007.
- [9] J. Wang, "Emerging Cognitive Radio application: A survey," *IEEE Communication Magazine*, vol. 49, No. 3, pp. 74–81, March 2011.

- [10] B. Wang "Advances in Cognitive Radio Network: A survey" IEEE Journal, Select Topics in Signal Processing, vol. 5, No.1, pp. 5-23, February 2011.
- [11] Hüseyin Arslan (Ed.), "Cognitive Radio, Software Defined Radio, and Adaptive Wireless Systems," University of South Florida, Tampa, FL, USA, Spring 2007.
- [12] L. Bixio, M. Ottonello, M. Raffetto and C. Regazzani, "Comparison among Cognitive Radio Architecture for Spectrum Sensing" EURASIP Journal on Wireless communication and network, Genova, Italy, vol. 2011, No. 749891, pp. 1-18, February 2011.
- [13] T. Song, J. Park, S. Min, J. Choi, K. Kim, C. Lee, K. Limm and J. Laskar, "A 122mW Low-Power Multiresolution Spectrum-Sensing IC with Self-Deactivated Partial Swing Techniques," IEEE Transactions on Circuit and system, vol. 57, No. 3, pp. 188-192, March 2010.
- [14] A. Ghasemi and E. S. Sousa, "Spectrum sensing in cognitive radio networks: requirements, challenges and design trade-offs," IEEE Communications Magazine, vol. 46, No. 4, pp. 32-39, April 2008.
- [15] T. Yücek and H. Arslan, "A survey of spectrum sensing algorithms for cognitive radio applications," IEEE Communications Surveys and Tutorials, Vol. 11, No. 1, pp. 116-130, March 2009.
- [16] A. Fehske, J. Gaeddert, and J. Reed, "A new approach to signal classification using spectral correlation and neural networks," IEEE International Symposium on New Frontiers in Dynamic Spectrum Access Networks, Baltimore, Maryland, USA, pp. 144-150, November 2005.
- [17] F. Akyildiz and B. Lo, "Cooperative Spectrum Sensing in Cognitive Radio Networks: A survey" ELSEVIER Journal Computers and Electrical Engineering, vol. 4, No. 1, pp. 40-62, December 2010.
- [18] J. A. Bazerque, G.B. Giannakis, "Distributed Spectrum Sensing for Cognitive Radio Networks by Exploiting Sparsity," IEEE transactions on signal Processing, vol. 58, No. 3, pp. 1847-1862, March 2010.
- [19] K. Divakaran, N. Manikandan, and S. Hari, "Wavelet based Spectrum Sensing Techniques for cognitive Radio- A Survey," Journal (IJCSIT), vol. 3, No. 2, pp. 123-137, April 2011.

- [20] B. Farhang-Boroujeny, "Filter bank spectrum sensing for cognitive radios," *IEEE Transactions on Signal Processing*, vol. 56, No. 5, pp. 1801–1811, May 2008.
- [21] E. Axell and E. G. Larsson, "Optimal and Sub-Optimal Spectrum Sensing of OFDM Signal in Known and Unknown Noise Variance," *IEE Journal on Selected Area in Communication*, vol. 29, No. 2, pp. 290-304, February 2011.
- [22] F. Bo, H. Fang, Z. A, and H. Fang, "Spectrum Sensing in MB-OFDM Based Cognitive UWB System Coexistence with WiMax," *IEEE Communication System ICCS*, Baton, Louisiana pp. 203-207, January 2009.
- [23] A. Tani and R. Fantacci, "A Low-Complexity Cyclostationary-Based Spectrum Sensing for UWB and Wimax Coexistence with Noise Uncertainty," *IEEE TRANSACTION on Vehicular Technology*, vol. 59, No. 6, pp. 2940-2950, July 2010.
- [24] S. Erkucuk, L. Lampe and R. Schober, "joint Detection of Primary System Using UWB Impulse Radios *IEEE Transaction on Wireless Communication*, vol. 10, No. 2, pp. 419-424, February 2011.
- [25] W. Zhang, R. K. Mallik, and K. Ben Letaief, "Optimization of Cooperative Spectrum Sensing with Energy Detection in Cognitive Radio Networks," *IEEE Transaction on wireless Communication*, vol. 8, No. 12, pp. 5761-5766, December 2009.
- [26] A. Kortun, T. Ratnarajah, and M. Sellathurai, "On the Performance of Eigenvalue-Based Cooperative Spectrum Sensing for Cognitive Radio," *IEEE Journal of Selected Topics in Signal Processing*, vol. 5, No. 1, pp. 49-55, February 2011.
- [27] J. Mitola and G.Q. Maguire, "Cognitive radio: Making software radios more personal", *IEEE Personal Communications Magazine*, vol. 6, No. 4, pp. 13-18, August 1999.
- [28] J. Unnikrishnan and V. Veeravalli, "Cooperative Sensing for Primary Detection in Cognitive Radio", *IEEE Journal of Selected Topics in Signal Processing*, vol. 2, No. 1, February 2008.
- [29] OFCOM, "Digital dividend: cognitive access", Consultation on licence-exempting cognitive devices using interleaved spectrum, London, UK, Publication date: 16 February 2009.
- [30] T.A. Weiss and F. Jondral, "Spectrum pooling: an innovative strategy for the enhancement of spectrum efficiency", *IEEE Communications Magazine*, vol. 42, No. 3, pp. 8 - 14 March 2004.

- [31] W. Lee and Dong-Ho Cho, "Sensing Optimization Considering Sensing Capability of Cognitive Terminal in Cognitive Radio System", *IEE 3rd International Conference on Cognitive Radio oriented Wireless Networks and Communications, CrownCom 2008*, Singapore, pp.1-6, May 2008.
- [32] A. Garhwel and P. Pratim " A Survey of Spectrum Sensing Techniques in Cognitive Radio" , *International Journal of Computer Science and Communication Networks (IJCCSN)*, vol. 1, No. 2, pp: 196-206, October 2011.
- [33] W. A. Gardner, "Introduction to Random Processer", with Application to signals and systems, *Electrical and Computer Engineering, University of California, Davis, USA*, 1986.
- [34] R. S. Robert, W. A. Brown, and H. H. Loomis,"Computationally Efficient Algorithms for Cyclic Spectral Analysis" *IEEE Signal Processing Magazine*, vol 8, No. 2, pp. 38-49, April 1991.
- [35] Phillip E. Pace, "Detection and Classifying Low probability of intercept Radar," *Naval postgraduate school, Monterey, CA, USA, Artech House*, 2009.
- [36] W. A. Gardner,"Exploitation of Spectral Redundancy in Cyclostationary Signals", *IEEE Signal Processing Magazine*, vol. 8, No. 2pp. 14-36, April 1991.
- [37] K. PO and J.TAKADA, "Signal Detection based on Cyclic Spectrum Estimation for Cognitive Radio", *IEEE 802.22 WRAN System," IEICE Technical Reports, Mijo University, Kani, Japan* vol. 106, No. 558, pp. 15-19, March 2007.
- [38] J.Mitola and G.Q.Maguire, "Cognitive radio: Making software radios more personal", *IEEE Personal Communications Magazine*, vol. 6, No. 4, pp. 13-18, August 1999.
- [39] J. Unnikrishnan and V. Veeravalli, "Cooperative Sensing for Primary Detection in Cognitive Radio", *IEEE Journal of Selected Topics in Signal Processing*, vol. 2, No. 1, pp. 18-27, February 2008.
- [40] C. Dasilva, B. Choi and K. Kin, " Distributed Spectrum Sensing for Cognitive Radio System" *IEEE conference, Lajolla, California, USA*, pp. 120-123, October 2007.
- [41] L. Emmanuel, and X.N. Fernando, " Wavelet-based spectral shaping of UWB radio signal for multisystem coexistence," *ELSEVIER Journal Computers and Electrical Engineering*, vol. 36, No. 2, pp. 261-268, Marche 2010.
- [42] "first report and order. Revision of part 15 of the commission's rules regarding ultra wideband transmission system," *Washington. NO. ET. Docket, USA*, pp. 98-153. FCC, April 2002.
- [43] D. J. Kadhim and S.Q. Jabbar,"A Spectrum Sensing Framework for UWB-Cognitive Network," *Journal, Wireless Sensor Network, "Wireless sensor Network (SciRes)*, pp. 649-654, August 2010.

- [44] W. H. Mims, M. A. Temple, R.F. Mills and B.D. Gronholz, "Spectrum Sensing Ultra Wideband Signals Using a Down-Converting Channelized Receiver," First IEEE International System, DySPAN '05, Baltimore, Maryland, USA, pp. 706-709, December 2005.
- [45] Hüseyin Arslan (Ed.), "Cognitive Radio, Software Defined Radio, and Adaptive Wireless Systems," University of South Florida, Tampa, Florida, USA, Spring 2007.
- [46] G. Andrea, C. Marco, D. Davide, and M. Riccardo, "Cognitive Radio with Ultra-Wide Bandwidth Location-Capable Nodes," Military Communication Conference, IEEE MILCOM 2007, Orland, Florida, USA, pp. 1-7, February 2008.
- [47] D. Cabrie, A. Tkachenko, and R.W. Brodersen, "Spectrum Sensing Measurements of Pilot, Energy, and collaborative Detection," IEEE Military Communication Conference, MILCOM 2006, Orland, Florida, USA, pp. 1-7, October, 2006.
- [48] D. Danev, "On Signal Detection Techneque for the DVB-T Standerd," IEEE 4th International Symposium on Communications, Control and Signal Processing, ISCCSP 2010, Limassol, Cyprus pp. 1-5, May 2010.
- [49] Y. Zeng. Y. C. Liang And R. Zhang, "Blindly Combined Energy Detection for Spectrum Sensing in Cognitive Radio," IEEE Signal Processing Letters, vol. 15, pp. 649-652, October 2008.
- [50] R. Tandra and A. Sahai, "Fundamental Limits on detection in low SNR under noise uncertainty," IEEE Communication and Mobile Computing, International Conference on 2005, California, USA, pp. 464-469, December 2005.
- [51] A. V. Dandawate and G. B. Giannaakis, "Statistical Test for Presence of Cyclosationary," IEEE Transactions on Signal Processing, vol. 42, No. 9, pp. 2355-2369, September 1994.
- [52] B. D. Gronholz, M. A. Temple, R. F. Mills and W. H. Mims, "Communication Channel Assessment: Detection of Utra Wideband Signals Using a Channelized Receiver," IEEE International Conference on Wireless Network, Communication and Mobile Computing, Ohio, USA, pp. 1017-1076, December 2005.
- [53] K. Jia and Z. He, "Detection performance analysis of the Digital Channelized Receiver-based ACML detector," IEEE Apperceiving Computing and Intelligence Analysis (ICACA), Barcelona, Spain, pp. 238-241, December 2009.
- [54] S. Manoj, Ramesh R. Rao and Michele Zorzi, "Architectures and Protocols for Next Generation Cognitive Networking," Springer, Cognitive Wireless Networks, . F.H.P. Fitzek and M.D. Katz(eds.), pp. 271-284, Feberuary 2007.

- [55] Jun Ma, Geoffrey Ye Li, and Biing Hwang (Fred) Juang, "Signal processing in cognitive radio," *Proceedings of the IEEE*, Vol. 97, No. 5, pp. 805–823, May 2009.
- [56] H. Vu Van and I. Koo "A Novel Cluster-Based Cooperative Spectrum Sensing with Double Adaptive Energy Thresholds and Multi-Bit Local Decision in Cognitive Radio" *KSIIT Transaction (Journal Magazine) on internet and information system*, vol. 3, No. 5, pp. 461-471, October 2009.
- [57] D. Jiaqi, and L. Yong, "A Novel Cooperative Spectrum Sensing Scheme Based on Clustering and softened Hard Combination" *IEEE International Communication, Network and Information Security (WCNIS '10)*, Beijing, China, pp. 183-187, August 2010.
- [58] Y. Hur, J. Park, W. Woo, K. Lim, C.-H. Lee, H.S. Kim and J. Laskar, "A wideband analog multi-resolution spectrum sensing (MRSS) technique for cognitive radio (CR) systems," *IEEE International Symposium on Circuits and Systems*, Atlanta, GA, USA, pp. 4090–4093, September 2006.
- [59] Jun Ma, Guodong Zhao and Ye (Geoffrey) Li, "Soft combination and detection for cooperative spectrum sensing in cognitive radio networks," *IEEE Transactions on Wireless Communications*, vol. 7, No. 11, pp. 4502–4507, November 2008.
- [60] D. Duna, L. Yang. And J. princep, "Cooperative diversity of spectrum sensing for cognitive radio systems," *IEEE Transaction on signal processing*, vol. 58, No. 6, PP. 3218-3227, June 2010.
- [61] J. Park, Y. Hur, T. J. Song, K. Kim, J. Lee, K. Lim, C.-H. Lee, H. S. Kim, and J. Laskar, "Implementation issues of a wideband multi-resolution spectrum sensing (MRSS) technique for cognitive radio (CR) systems," *IEEE 1st International Conference on Cognitive Radio Oriented Wireless Networks and Communications*, Atlanta, GA, USA, pp. 1–5, June 2006.
- [62] Y. Hur, J. Park, T. J. Song, K. Kim, J. Lee, K. Lim, C.-H. Lee, H. S. Kim and J. Laskar, "A cognitive radio (CR) System Employing A Dual-Stage Spectrum Sensing Technique: A Multi-Resolution Spectrum Sensing (MRSS) and A Temporal Signature Detection (TSD) Technique," *IEEE Global Telecommunication Conference (GLOBECOM)*, San Francisco, California, USA, pp. 1-5, December 2006.
- [63] J. Meng, W. Yin, H. Li, E. Hossain and Z. Han, "Collabrative Spectrum Sensing from Sparse Observation in Cognitive Radio Networks," *IEEE JOURNAL on selected areas in communications*, vol. 29, No. 2, pp. 327-337, February 2011.

- [64] H. Du, Z. Wei, Y. Wang, and D. Yang, "Hybrid Cooperative Spectrum Sensing Scheme Using Double-Fusion in Cognitive Radio Networks," *Journal of Computation Information System*, vol. 7, No. 5, pp. 1500-1507, May 2011.
- [65] P. Edward, L. Ying, G. Yong, Z. Yonghong, "Cooperative Spectrum Sensing in Cognitive Radio Network with Weighted Decision Fusion Schemes," *IEEE Transactions on Wireless Communications*, vol. 9, No. 12, pp. 3838-3847, December 2010.
- [66] Q. Choong, M. Motani, W. Wong and A. Nallanthan, "Cooperative Spectrum Sensing Strategies for Cognitive Radio Mesh Networks" *IEEE JOURNAL of Selected Topics in Signal Processing*, vol. 5, No. 1, pp. 56-67, February 2011.
- [67] R.D. Hippenstiel, "Detection Theory, Applications and Digital Signal Processing," CRC. Florida, USA, 2002.