

INFLUENCE OF HUMAN MILK ON THE DEVELOPMENT OF IMMUNE
RESPONSES IN INFANTS

A thesis submitted for the degree of Doctor of Philosophy

by

Susan Stephens

Division of Communicable Diseases,
Clinical Research Centre, Harrow

and

Department of Applied Biology,
Brunel University

August 1984

ABSTRACT

BRUNEL UNIVERSITY, UXBRIDGE, DEPARTMENT OF APPLIED BIOLOGY

Susan Stephens 1984 Ph.D.

Influence Of Human Milk On The Development Of Immune Responses In Infants

The aim of this study was to determine whether breast milk had a stimulating effect on the development of immune responses in infants. Breast- and bottle- fed infants were studied from birth to 9 months of age. Several significant differences in immune responses were found between the groups. These differences were related to age and fell into two main time periods.

In the early neonatal period, lymphocytes from breast-fed infants showed significantly greater spontaneous proliferation and proliferative responses to the T cell mitogen PHA *in vitro* than cells from bottle-fed infants. This may be due to a stimulatory effect *in vivo* of the growth factors and lymphokines in human milk acting on T cells and/or their precursors. Serum immunoglobulin levels did not however, reflect this increased lymphocyte responsiveness and although salivary IgM and IgA levels were significantly increased in the breast-fed infants at 6 days of age, this may have been due to residual milk immunoglobulins.

In contrast, by 3 to 9 months of age, the cells from the bottle-fed group showed significantly greater *in vitro* proliferation of all classes of lymphocytes than the cells from the breast- fed infants. Salivary IgM and IgA levels and serum IgM antibodies to commensal gut organisms were also significantly higher in bottle-fed infants at this time. This indicated a higher rate of *in vivo* stimulation of the immune system in bottle-fed infants. It is suggested that this is due to an increased exposure of bottle-fed infants to antigenic material at mucosal surfaces and a greater uptake of these local antigens into the systemic circulation.

Breast-feeding may therefore have contrasting effects on the development of immune responses, a stimulating effect by growth factors, particularly in the early immature period, and a suppressive effect resulting indirectly from exclusion of antigens (including those of a potentially harmful nature).

ACKNOWLEDGEMENTS

The results presented in this thesis are part of a study on which I was working as a Research Officer at the Clinical Research Centre, Harrow. I am indebted to Sir Christopher Booth and to the Medical Research Council for being allowed to write up this study for the degree of PhD. I would like to thank Dr D.A.J.Tyrrell for his initial encouragement to carry out this work in his Department. I am also indebted to Dr J.Farrant, not only for his supervisory role but also for his patience in teaching me to grow lymphocytes instead of bacteria and for trying to expand my knowledge of computing and statistics. For the majority of the statistical analyses, I am particularly grateful to Stephen Duffy, (who sometimes felt his brief was to find as many significant differences as possible!), who has spent many hours on the analysis of variance in Chapter 4, and other analyses in Chapters 4 and 6. I would also like to thank Dr M.K.Brenner for his continued encouragement throughout the study and Prof R.J.Terry for his stimulating teaching of Immunology, for his concern and for his generosity with time.

For their paediatric expertise and for their skill in venepuncture, which allowed me to collect sufficient blood samples for so many studies, I must thank Dr P.K.Lakhani and Dr C.R.Kennedy. But perhaps most important are the donors. To the thirty volunteered infants and their generous and interested mothers, I must offer the greatest thanks - they provided sufficient sample material for over 10,000 data points on lymphocyte proliferation alone. I also wish to thank Dr H.B.Valman for encouraging the study to be conducted on patients at Northwick Park Hospital; the Maternity Ward staff,

Research Sister Kathy Lawrence and visiting mid-wives for their co-operation. Also, my thanks go to the National Childbirth Trust volunteers, whose enthusiasm in this study and for the cause of breast-feeding generally, resulted in my having reluctantly to turn volunteers away.

Finally, I would like to offer special thanks to Dr J.M.Dolby, whose support throughout my career has been greatly appreciated.

This study was approved by the Ethical Committee of NPH (E.C. 772). The work described in this thesis is entirely my own except where otherwise stated.

When I was twenty inches long
I could not hear the thrushes' song
The radiance of morning skies
Was most displeasing to my eyes.

For loving looks, caressing words,
I cared no more than sun or birds
But I could bite my mother's breast
And that made up for all the rest.

Frances Cornford

Collected Poems

Cresset Press

London 1954

ABBREVIATIONS

BSA	Bovine Serum Albumin
CBL	Cord Blood Lymphocytes
C.I.	Confidence Interval
CRC	Clinical Research Centre
DF	Degrees of Freedom
DMSO	Dimethyl sulphoxide
EBV	Epstein-Barr Virus
ELISA	Enzyme-linked Immunosorbant Assay
FCS	Foetal Calf Serum
Glut	L-glutamine 2mM/ml
Ig	Immunoglobulin
IHA	Indirect Haemagglutination
IMDM	Iscove's Modified Dulbecco's Medium
Lf unit	Limes flocculating unit
LPS	Lipopolysaccharide
MLR	Mixed Lymphocyte Reaction
NPB	Northwick Park Hospital
PBL	Peripheral Blood Lymphocytes
PBM	Peripheral Blood Mononuclear Cells
PBS	Phosphate Buffered Saline
Pen/Strep	Penicillin 100I.U./ml, plus Streptomycin 100ug/ml
PFC	Plaque-forming Cell
PHA	Phytohaemagglutinin
PWM	Pokeweed Mitogen
RIA	Radioimmunoassay
RT	Room Temperature
SAC	<i>Staphylococcus aureus</i> (strain Cowan)

SC	Secretory Component
SD	Standard Deviation
sIgA	Secretory Immunoglobulin A
TF	Transferrin
TT	Tetanus Toxoid
WBC	White Blood Cell
WHO	World Health Organisation

ABSTRACT	1
ACKNOWLEDGEMENTS	2
ABBREVIATIONS	4
CONTENTS	6-16

CHAPTER 1

HISTORICAL INTRODUCTION	17-54
--------------------------------	--------------

SECTION A - INFANT FEEDING

1) History of infant feeding	18
2) Infection rates in infants: effects of feeding method	22
3) Breast-feeding and allergy	25

SECTION B - ANTI-INFECTIVE PROPERTIES OF HUMAN MILK

1) Non-specific factors	26
i) Control of normal gut flora	26
ii) Enzymes	27
iii) Iron-binding proteins	28
iv) Cell growth factors	28
2) Specific factors	30
i) Cells	
a) Macrophages	30
b) Lymphocytes	31
ii) Immunoglobulins	32
iii) Specificity of antibodies in milk	35

SECTION C - IMMUNOLOGICAL STATUS OF THE INFANT I

SYSTEMIC IMMUNITY

1) Lymphocytes and their function	36
2) <i>In-vitro</i> tests of lymphocyte activation and function	
i) Phytohaemagglutinin	38
ii) Pokeweed mitogen	38
iii) <i>Staph.aureus</i> (Cowan)	39
iv) Allogeneic lymphocytes	39
v) Specific antigen	40
3) Ontogeny of circulating lymphocytes	40
4) Immune function of the infant at birth. Studies on cord blood.	41
i) Cell-mediated immunity	42
ii) B cell responses and immunoglobulin production <i>in vitro</i>	43
iii) Immunoglobulins in cord blood	44
iv) Non-specific immunity, neutrophils	45
5) Changes in immunity with age	
i) Immunoglobulin levels	45
ii) Lymphocyte function <i>in vitro</i>	47

SECTION D - IMMUNOLOGICAL STATUS OF THE INFANT II

LOCAL IMMUNITY

1) Gut-associated lymphoid tissue (GALT) and lymphocyte pathways	48
2) Secretory immunoglobulins	50
3) Local non-specific defence mechanisms	51

SECTION E - EFFECT OF DIET ON IMMUNITY	52
--	----

SECTION F - PLAN OF THESIS	53
----------------------------	----

CHAPTER 2

MATERIALS AND METHODS

55-78

SECTION A - SUBJECTS AND SAMPLES

1) Selection of infants	55
2) Visits and Questionnaires	56
3) Collection of Samples	57

SECTION B - MATERIALS

1) Phytohaemagglutinin	58
2) Pokeweed mitogen	58
3) Tetanus toxoid	58
4) Preparation of Mitogen from <i>Staph. aureus</i>	58
5) Preparation of <i>E.coli</i> 'O' LPS antigen	59
6) Preparation of Stimulator cells for mixed lymphocyte reaction	59
i) Cell culture	60
ii) Mitomycin-C Treatment	60
iii) Freezing of stimulator cells	60

SECTION C - CELL CULTURES

1) Serum-free Medium for Proliferation experiments	61
2) Serum-free medium for <i>in-vitro</i> Immunoglobulin Production	61
i) Basic medium	61
ii) Transferrin	62
iii) Delipidated bovine serum albumin	62
iv) Soybean lipid	63

3) Microculture technique

- i) Separation of cells from peripheral blood 63
- ii) Terasaki plate microculture system 64
- iii) Mixed lymphocyte cultures 64
- iv) Harvesting cultures for proliferation studies 67

SECTION D - IMMUNOGLOBULIN AND ANTIBODY ASSAYS

1) Standards for radioimmunoassay

- i) Preparation of Affinity Purified Anti-*E.coli* Standard
 - a) Coupling of *E. coli* antigen to Sepharose 68
 - b) Purification of serum 68
- ii) Affinity-purified anti-tetanus toxoid antiserum 70
- iii) Other standards
 - a) IgG k anti-TT monoclonal antibody 70
 - b) IgM and IgA 70

2) Preparation of iodinated class-specific antisera

- i) Coupling of immunoglobulin to CN-Br Sepharose 71
- ii) Iodination of coupled anti-immunoglobulins 71

3) Solid-phase Radioimmunoassay Technique

- i) Basic technique 72
- ii) Standardisation of RIA 73
 - a) Specificity of anti-immunoglobulins 76
 - b) Non-specific binding controls 76
 - c) Negative Controls 78

CHAPTER 3

FAMILIES AND INFANTS

79-106

SECTION A - ANALYSIS OF QUESTIONNAIRES

1) Family History	79
2) Maternal Age	80
3) Social Class and Socioeconomic Groups	80
4) Pregnancies and Births	83
5) Siblings	83
6) Feeding Regimes	
a) Breast-fed infants	87
b) Bottle-fed infants	87
7) Intercurrent Infections	87
a) Upper Respiratory Tract Infections	91
b) Gastrointestinal Tract Infections	92
c) Other Infections	92
8) Allergies	92
9) Vaccination schedules	93

SECTION B - GENERAL HAEMATOLOGY

1) Total Cell Numbers	95
2) Differential WBC Numbers	96

SECTION C - DISCUSSION

1) Family differences between feeding groups	102
2) Role of social factors in infection rates	103
3) Breast-feeding does not fully protect the infant	
i) Infections	104
ii) Allergies	105
4) WBC counts and infections	105
SUMMARY	106

CHAPTER 4

MONONUCLEAR CELL PROLIFERATION IN VITRO 107-158

SECTION A - INTRODUCTION 107

SECTION B - METHODS AND STANDARDISATION OF CULTURE CONDITIONS

1) Doses of stimulators	110
i) PHA	110
ii) PWM	111
iii) <i>Staph.aureus</i> (Strain Cowan) (SAC)	111
iv) Allogenic lymphocytes (MLR)	111
v) Tetanus toxoid (TT)	112
2) Responder Cell Concentrations	112
3) Days of culture for harvesting	113
4) Statistical analyses	113

SECTION C - GENERAL OBSERVATIONS ON PROLIFERATION BY INFANT PBM CELLS

1) Comparison of infant and adult cell cultures	131
2) Effect of differing cell concentrations	131
3) Effect of harvesting on different days of culture	131
4) Effect of age on cell proliferation	132

SECTION D - DIFFERENCES IN PROLIFERATION BETWEEN FEEDING GROUPS

1) Spontaneous proliferation	135
2) Responses to mitogens	
i) PHA	136
ii) PWM	137
iii) SAC	137
3) Proliferative responses to allogeneic lymphocytes	138
4) Proliferative responses to Tetanus Toxoid	139

SECTION E - DISCUSSION

1) General responses by infant and adult cells	153
2) Differences between breast- and bottle-fed infants	156

CHAPTER 5

159-190

B CELL DIFFERENTIATION AND IMMUNOGLOBULIN PRODUCTION *IN VITRO*

SECTION A - IMMUNOGLOBULIN PRODUCTION BY UNSEPARATED

INFANT MONONUCLEAR CELLS

1) Introduction	160
2) Spontaneous immunoglobulin production by unstimulated infant PBM cells	
i) Influence of age on Ig production by unstimulated cells	161
ii) Influence of breast- or bottle-feeding	161
3) Response to PWM	163
4) Response to Tetanus toxoid	
i) Titration for optimal dose of antigen	164
ii) Total IgM production	165
iii) Total IgG production	169
iv) Specific antibody production	169
5) IgA production <i>in vitro</i>	169

SECTION B - PRODUCTION OF SPECIFIC ANTIBODY

1) Standardisation of lipid in serum-free medium	172
2) Addition of growth and differentiation factors for B cells	174
3) Depletion of monocytes	176
i) Adult cell cultures	176
a) Total IgM secretion	178
b) IgG anti-TT antibody secretion	178
ii) Infant cell cultures	178
4) Depletion of T-cells	180
i) Methods for depletion of T cells	
a) Coating of plates with anti-mouse IgG	180
b) Reaction of T cells with monoclonal antibodies	181
ii) Antibody production	181

SECTION C - DISCUSSION

1) Immunoglobulin production by unseparated PBM cells	183
2) Attempts to enhance Ig and specific antibody production <i>in vitro</i>	185
SUMMARY	188

CHAPTER 6

IN VIVO STUDIES ON INFANT SERA

191-221

SECTION A - INTRODUCTION

- | | |
|--|-----|
| 1) Absorption of milk immunoglobulins | 191 |
| 2) Stimulation of immunoglobulin production <i>in vivo</i> | 192 |
| 3) Techniques | 193 |

SECTION B - IMMUNOGLOBULIN AND ANTIBODY ASSAYS

- | | |
|---|-----|
| 1) Nephelometry for total IgG, IgM and IgA | 194 |
| 2) Indirect haemagglutination (IHA) for <i>Escherichia coli</i>
antibodies | 194 |
| 3) Enzyme-linked Immunosorbent Assay (ELISA) for <i>E.coli</i>
antibodies | 195 |
| 4) Solid-phase Radioimmunoassay method (RIA) | 197 |
| 5) Statistics | 197 |

SECTION C - RESULTS

- | | |
|--|-----|
| 1) Comparison of nephelometry and RIA for total immunoglobulin
levels | |
| i) IgG | 197 |
| ii) IgM and IgA | 198 |
| 2) Comparison of IHA, ELISA and RIA for <i>E. coli</i> antibodies | |
| i) Correlation of the tests | 198 |
| ii) Quantification of <i>E.coli</i> antibodies | 198 |
| 3) Total immunoglobulins in breast- and bottle-fed infants | 201 |
| i) IgG | 204 |
| ii) IgM | 204 |
| iii) IgA | 204 |

4) Tetanus toxoid antibodies	
i) General response	206
a) IgG anti-TT	206
b) IgM anti-TT	207
c) IgA anti-TT	207
ii) Comparison of breast- and bottle-fed infants	211
5) Antibodies to E. coli 'O' LPS antigens	
i) IgG anti-E.coli	211
ii) IgM anti-E.coli	211
iii) IgA anti-E.coli	213
SECTION D - DISCUSSION	
1) Total immunoglobulins	213
2) Specific antibody responses	
i) Responses to Tetanus toxoid vaccination	215
ii) Responses to normal gut flora	
a) Disparity between IHA and RIA	216
b) Differences between Breast- and bottle-fed infants	216
3) Reduced systemic exposure to gut antigens in breast-fed infants	
i) Normal gut flora	217
ii) Milk antibodies	218
iii) Foreign protein	218
iv) Epithelial growth factors	218
4) Overall similarity of breast- and bottle-fed infants	219
SUMMARY	220

CHAPTER 7

IN-VIVO STUDIES ON SECRETIONS

222-248

SECTION A - INTRODUCTION

SECTION B -- METHODS

1) Processing of saliva samples	223
2) Total Protein Estimations	223
3) Radioimmunoassay for immunoglobulins	224
4) Statistics	224

SECTION C - RESULTS

1) Total immunoglobulin levels in undiluted saliva	
i) IgG	225
ii) IgM	225
iii) IgA	225
2) Total protein estimations	230
3) Immunoglobulins concentrations expressed per milligram of protein	230
i) IgG	233
ii) IgM	233
iii) IgA	233
4) Relationship between Ig concentrations in the saliva of breast-fed infants and the time since the last milk feed.	236
5) Relationship between salivary and serum Ig levels.	
i) IgG	236
ii) IgM	236
iii) IgA	237
6) Specific Antibodies in saliva	
i) Antibodies to tetanus toxoid	237
ii) Antibodies to <i>E.coli</i>	238

SECTION - DISCUSSION

1) Development of IgG in saliva of infants	240
2) Development of IgM in infant saliva	241
3) Development of IgA in infant saliva	242
4) Specific antibodies in saliva	243
5) Differences in salivary immunoglobulins in breast- and bottle-fed infants	244
6) Total protein levels in saliva	246

CHAPTER 8

GENERAL DISCUSSION	249-258
1) Differences between feeding groups	249
a) Immunological functions enhanced in breast-fed infants	249
b) Functions which appear similar in both feeding groups	251
c) Enhanced immune responses in bottle-fed infants	251
i) Role of cow milk antigens	252
ii) Role of passive protective factors in human milk in modulating antigenic exposure	253
iii) Active protection of infants by epithelial growth factors in milk	254
2) Role of normal gut flora in the development of immune responses	254
REFERENCES	259-280
APPENDIX	281

CHAPTER 1

HISTORICAL INTRODUCTION

The aim of this study is to determine whether human milk has any active role in the development of the immune system in breast-fed infants. In order to investigate this possibility, several aspects of immunity have been investigated in both breast-fed and bottle-fed infants. Although much work has been done in the past on human milk, the study of immunity in infants has been less thoroughly investigated due to the ethical difficulties in obtaining sufficient material from healthy infants. The development of microculture techniques for lymphocytes, and more sensitive assays for detection of immunoglobulins and antibodies, has enabled the present study to be conducted using very small volumes of infant blood and secretions.

Because of the lack of material from infants, much of the work on the role of milk in protecting newborn offspring has been done in animals. Although animals have proved valuable models, the variations in milk proteins between species, and the differences in placentation and the post-partum intestinal uptake of macromolecules by the neonatal gut, have meant that these studies are frequently only of relevance to the particular species studied. This introduction will therefore be concerned primarily with work carried out on human milk and on the development of immunity in human infants. Work in other species will only be referred to where it is directly relevant to the human studies.

The review of previous work is divided into three sections. The first section will deal with the history of infant feeding in England and other industrialised countries, and the effect that changes in feeding patterns have had on infection rates and incidence of allergic disease. The second section will review the anti-infective properties of human milk, and the third section will be concerned with the immune status of the infant at birth and during the first year of life.

SECTION A - INFANT FEEDING

1) History of infant Feeding

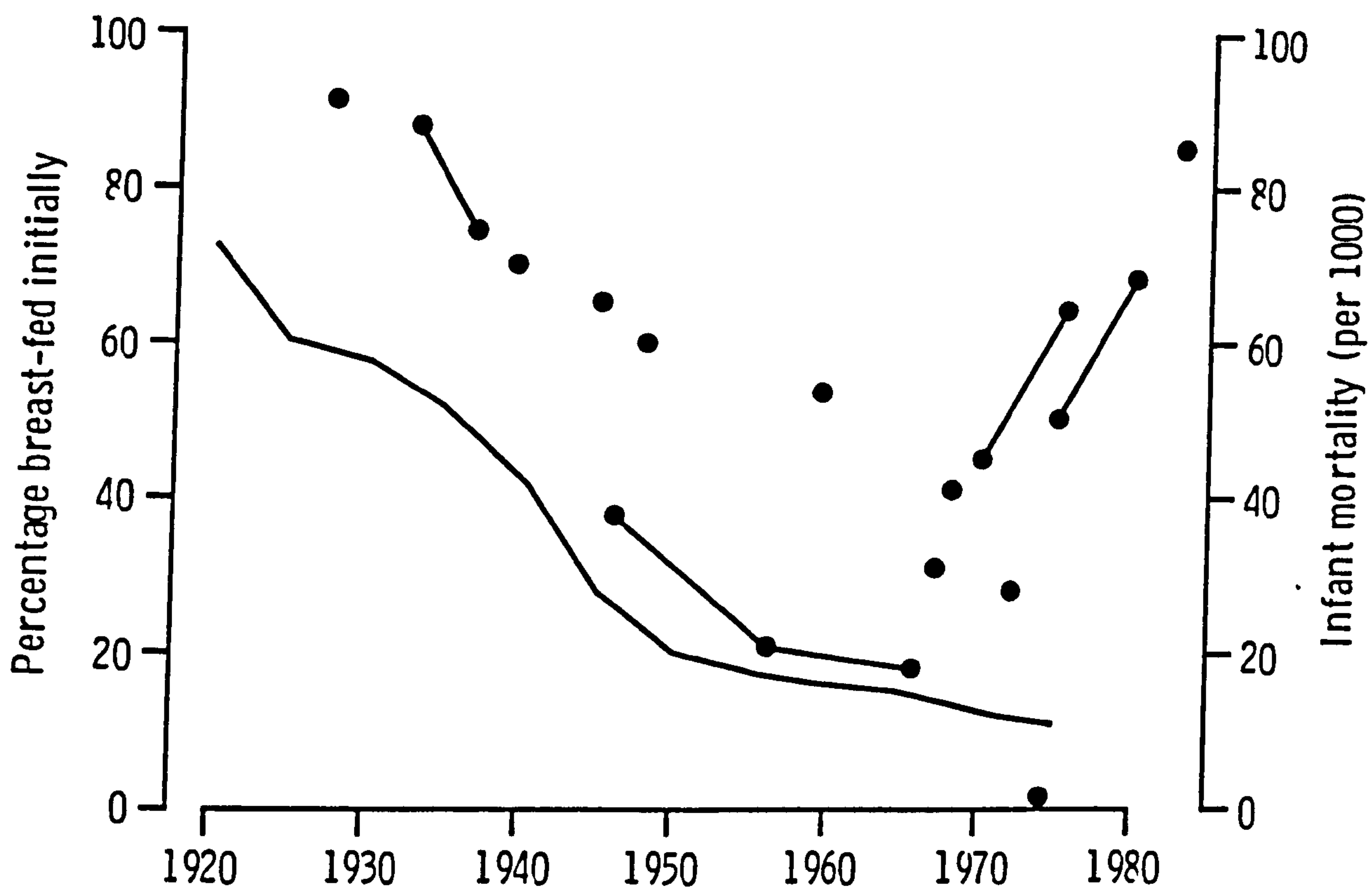
Infant feeding is a very emotive subject. Many thousands of articles have been written, expounding the virtues of either breast or bottle as far as nutrition, convenience, mother-infant bonding, frequency of infections and many other aspects of infant care are concerned. But whereas today's mothers in Europe and North America have a choice between breast-feeding, or bottle-feeding using a variety of commercially available and relatively cheap cow milk preparations, as recently as a century ago there was no safe alternative to breast milk. This meant that any mother who was unable to feed her infant had to find another lactating mother (wet nurse), or the infant was likely to die. In fact the use of wet nurses spread beyond the demands of necessity to become merely a convenience, and by the 17th and 18th centuries as many as 15% of infants were being nursed away from their mother's home by wet-nurses, often until 2 years of age (Sussman, 1977).

During the second half of the 19th century, the Industrial Revolution had two important effects on the pattern of infant feeding. First, the improvement in transport and marketing of cow milk made it more readily available to people living in the towns. Second, social changes resulted in a greater need for women to work in the factories, rather than to stay at home and feed their infants. Although the feeding of raw cow milk to infants was known to be extremely hazardous, it became more and more common at this time (Jelliffe and Jelliffe, 1979), sometimes amidst appalling conditions of poverty and hygiene. During the last quarter of the 19th century, the realisation of the association between micro-organisms and disease, led to the introduction of sterilisation of milk for infants. This was a major step in the increase in popularity of bottle-feeding. From about 1890, with the development of the milk formula industry and improvement of the quality of cow milk preparations, these formulae became cheaper and wet nurses became relatively more expensive. This resulted in a rapid decline in wet nursing during the first 20 years of this century. As the milk formula industry developed, it inevitably set about creating a need for its products. Advertisements extolled the virtues of rival brands and emphasised that cow milk preparations were not only nutritionally satisfactory and more convenient than breast milk, they were also somehow more modern and more hygienic. The propaganda was successful and following the decline in wet nursing came a similar decline in breast-feeding generally (Fig. 1 - 1).

Figures available on the rates of breast-feeding vary according to area and also social class, with the lower social classes tending to favour bottle-feeding. Studies between 1924-1929 indicated that

Figure 1 - 1

Incidence of breast-feeding and infant mortality rates in Western Europe and U.S.A.



References for incidence of breast-feeding:- Grulée, Sanford and Herron (1934); Spence (1938); Robinson (1951); DHSS Report (1974); Goel, House and Shanks (1978); Wharton (1982).

Reference for infant mortality rates:- Jelliffe and Jelliffe (1978).

in parts of the U.S.A. over 90% of infants were initially breast-fed (Grulée, Sanford and Herron, 1934). Spence (1938) reported a fall in breast-feeding from 88% to 75% in a 4 year period between 1933-1936. By the 1940's this figure had fallen to 65% and by 1972 to 28% (Nutrition Committee, 1978). A similar decline in the rate of breast-feeding occurred in England, with a fall from 70% in the late 1930's (Robinson, 1951), to 28% in 1972 (DHSS report, 1974). The figures for Scotland are even lower, with as few as 1% attempting to breast-feed in one study between 1974-6 (Goel, House and Shanks, 1978). Associated with this decline in the number of mothers attempting to breast-feed, was a reduction in the duration of successful breast-feeding (Jelliffe and Jelliffe, 1978).

Apart from the effects of breast- or bottle-feeding on infection rates, which are discussed in detail below, there have been many investigations comparing the nutritional and biochemical composition of human milk and cow milk formulae, (DHSS, 1974; Nutrition Committee, 1978). The areas of study have concentrated on protein and lipid content, on nitrogen, iron and vitamins, as well as on renal solute loads. Improvements in formulae have resulted in bottle-fed infants having similar serum calcium, urine osmolality and plasma urea to those of breast-fed infants (Addy, 1976).

Recent reports have indicated that the decline in breast-feeding has now been reversed (Nutrition Committee, 1978). However, a social trend of this nature is slow to change and re-education takes many decades to reach all levels of society. The fact that the determined promotion of breast-feeding at Northwick Park Hospital has resulted in up to 85% of infants receiving exclusive breast-feeding for at least

the first week of life is encouraging. Other centres are also beginning to report similar success rates (Wharton, 1982).

2) Infection rates in Infants: effects of feeding method.

The remarkable decline in breast-feeding in Europe and the U.S.A. during the first 70 years of this century, occurred in spite of overwhelming evidence that bottle-feeding resulted in higher infant morbidity and mortality rates. One of the reasons for this was that during this period in the industrialised countries, there was a very remarkable decline in infant mortality generally (Fig. 1 - 1). This was due to greatly improved sanitation and living standards, better medical facilities and the introduction of antiseptics and antibiotics. This general decline in infant mortality and morbidity, detracted from the relative infection rates in the two feeding groups. Perhaps the true hazards of bottle-feeding only became appreciated when cow milk formulae started to be promoted in underdeveloped countries, with disastrous results for the mortality rates.

In the 17th and 18th centuries, documentation of infection rates in infants fed by wet nurses in comparison to those fed by their own mothers was poor, but by the latter half of the 19th century, records indicate that the mortality of infants fed by wet nurses was higher (Sussman, 1977). This may be due to associated adverse factors such as the higher illegitimacy rate among wet nursed children, and the fact that the wet nurses themselves were often extremely poor, frequently prostitution was their only alternative means of earning a living. Their own infants either starved or were passed down to cheaper (and therefore poorer) wet nurses. The earliest records of any careful studies on infection rates in infants fed boiled cow milk

preparations, and those fed by their own mothers at the breast, are by Bockh (as quoted by Mellander, Vahlquist and Mellbin, 1959). Bockh studied infants in Berlin for three 1 year periods at 10 year intervals from 1885, and showed that the mortality rate was much higher in the artificially fed infants but that this rate fell more rapidly than for the breast-fed infants during the 20 year period of the study. In England, Newman in 1906 (as quoted by Goldman and Smith, 1973) noted six times more cases of gastroenteritis in bottle-fed infants than in breast-fed infants.

In an extensive study of 20,000 infants conducted in Chicago between 1924-1929, Grulée, Sanford and Herron (1934) showed that although only 8.5% of the infants studied were totally bottle-fed, this group accounted for 66% of the mortality. They also showed that morbidity caused by gastroenteritis, respiratory tract infections and other diseases was considerably higher in the bottle-fed group. It is interesting to note that in spite of the overwhelming evidence presented for the protective benefits of breast milk, in the discussion that followed their paper, the validity of the results was questioned in view of the continued improvement of cow milk preparations! In 1936-42, another extensive study by Robinson (1951) in a poor area of Liverpool, again showed significantly lower morbidity and mortality from infections (gastroenteritis, respiratory tract, otitis and infectious fevers) in breast-fed infants. In this study, in addition to the marked benefits of breast-feeding, both smaller family size and more rapid medical attention were also associated with lower morbidity and mortality, although social class was not found to have any direct effect on infection rates.

Smaller studies comparing the feeding groups continued to show a protective effect of breast milk, (Smellie, 1939; Ebbs and Mulligan, 1942; Mellander, Vahlquist and Mellbin, 1959; Ironside, Tuxford and Heyworth, 1970; Winberg and Wessner, 1971). A powerful argument on the protective role of colostrum and milk came from the control of two epidemics of diarrhoea caused by *Escherichia coli* in nurseries, by feeding colostrum to the infected infants, after antibiotic therapy had failed to control the outbreak (Svirsky-Gross, 1958; Tassovatz and Kotsitch, 1961). Although evidence was accumulating on the anti-infective role of breast-feeding, some studies in more affluent areas suggested that high levels of hygiene and medical care could reduce the infection rates in bottle-fed infants to those found in breast-fed infants (Stevenson, 1947; Norval and Kennedy, 1949; Stewart and Westropp, 1953). Since there was a trend for the higher social classes to breast-feed, it was suggested that the differences between the groups could be attributed to better living conditions rather than to the type of milk. However, in a study in rural Chile, where only the wealthier families could afford the cow milk formulae, Plank and Milanesi (1973) showed that as living standards rose, more infants were totally bottle-fed and infant mortality increased. It was not until the late 1970's, (Cunningham, 1977; 1979) that studies in the U.S.A. showed that even after socio-educational status, family size, day care exposure and birthweight were taken into account, there was still a significant protective effect of breast milk, particularly in the early months and against the more serious illnesses. This has since been confirmed in other countries for gastrointestinal infections (Chandra, 1979; Gunn *et al*, 1979; Whorwell *et al*, 1979; France, Marmer and Steele, 1980) and respiratory tract infections

(Pullan *et al*, 1980), including one study on respiratory tract infections in the Harrow area (Watkins, Leeder and Corkhill, 1979).

3) Breast-feeding and allergy

Although few now question the role of breast milk in protecting newborn infants against infectious diseases, particularly in areas of poor hygiene and high disease incidence, the role of human milk in protecting against allergy is more controversial. Chandra (1978) showed that siblings of children with atopic disease had significantly less eczema, recurrent wheezing and lower serum IgE levels for up to 3 years if they were exclusively breast-fed for at least 8 weeks from birth. Saarinen *et al* (1979) showed a similar reduction in atopic disease in breast-fed infants who had a high risk of atopy, and suggested that both breast milk and allergen exclusion were needed. More recently, Fergusson, Horwood and Shannon (1983) were unable to demonstrate any reduction in the incidence of asthma in breast-fed infants, although the infants studied were not from families with a history of allergy. It appears that in selected groups of infants who have a high risk of developing allergies, breast-feeding may play a role in at least delaying the onset of allergic disease; however, allergen exclusion for the first few months and graduated weaning are also important factors (Bjorksten, 1983).

SECTION B - ANTI-INFECTIVE PROPERTIES OF HUMAN MILK

The lower incidence of infections in breast-fed infants has led to the investigation of colostrum and milk for antimicrobial factors. Detection of specific antibodies by agglutination and bactericidal techniques was first described in the early 1900's (reviewed in Nordbring, 1957). Non-specific antimicrobial activity was also demonstrated at this time (see Mellander, Vahlquist and Mellbin, 1959). Since the discovery of secretory IgA (sIgA), and with the development of more sensitive techniques for detecting class-specific antibodies and other antimicrobial proteins, many different antimicrobial systems have been demonstrated in human milk. These have been the subject of several reviews (Hanson and Winberg, 1972; Goldman and Smith, 1973; Head, 1977; Butler, 1979; Welsh and May, 1979). The individual systems and their known interactions *in vitro* will be outlined below; it must be emphasised that the relative importance of each component *in vivo* for the human neonate remains to be elucidated.

1) Non-specific factors

These are factors, demonstrated in human milk, that either directly or indirectly inhibit the growth of several species of micro-organisms.

i) Control of Normal Gut Flora

The establishment of a commensal gut flora is an important part of the infants' gut defences and there are several properties of human milk which are known to influence the development of normal gut flora (Borriello and Stephens, 1984). Gyorgy, (1971) has demonstrated

nitrogen containing oligo- and polysaccharides which enhance the growth of anaerobic Lactobacilli (bifidus factor). The pH of the stools of the breast-fed infant is lower than that of artificially fed infants (Ross and Dawes, 1954); this may be due to the predominance of the Lactobacilli and the low buffering capacity of human milk (Bullen and Willis, 1971). Low pH enhances the antimicrobial properties of formic acid and other intestinal fatty acids and produces an environment generally unfavourable for the growth of intestinal pathogens such as enteropathogenic *E.coli*.

Receptor analogues may also have a role in modulating gut flora. Williams and Gibbons (1975) have demonstrated inhibition of streptococcal attachment to epithelial cells by antigenically similar salivary glycoproteins. In human milk, Holmgren, Svennerholm and Lindblad (1983) have isolated receptor-like glycoconpounds which inhibit *Vibrio cholerae* adherence. The specificity and *in-vivo* function of these receptor analogues has yet to be determined.

ii) Enzymes

Lysozyme is present in large quantities in mature human milk (200-300 μ g/ml), and is one of the few proteins which increases in concentration during lactation (Goldman *et al*, 1982). It has been shown to kill a variety of gram-positive and gram-negative organisms *in vitro* (Reiter, 1978). Some workers have demonstrated a role of lysozyme in an IgA and complement mediated killing system (Wardlaw, 1962; Adinolfi *et al*, 1966), although other workers have not confirmed these results (Heddle *et al*, 1975). Lactoperoxidase is an enzyme present at low levels in human milk and at higher levels in infant saliva (Gothevors and Marklund, 1975). In a system involving

thiocyanate and hydrogen peroxide, the enzyme produces an intermediate oxidation product of the thiocyanate which is bactericidal against a variety of organisms *in vitro* (Reiter *et al*, 1963; Stephens, Harkness and Cockle, 1979).

iii) Iron-binding proteins

Human milk contains between 1-6mg/ml lactoferrin and a smaller quantity of transferrin (15-20 μ g/ml). These iron-binding proteins have been shown to have a strong bacteriostatic effect *in vitro* (Masson *et al*, 1966) probably because chelated iron is unavailable to the bacteria. Some bacteria (such as *E.coli*) are able to by-pass this inhibitory effect by secreting iron sequestering compounds (enterochelins) which are then actively taken up by the organisms. A bacteriostatic system against these organisms, involving IgG and lactoferrin, has been demonstrated *in vitro*, and experiments in guinea pigs have suggested this system may be important *in vivo* (Bullen, Rogers and Leigh, 1972). A similar *in-vitro* bacteriostatic system has been demonstrated for sIgA and lactoferrin (Rogers and Synge, 1978; Spik *et al*, 1978). This potentiation of lactoferrin by antibody may be mediated by immunoglobulin blockade of bacterial enterochelin secretion (Rogers and Synge, 1978).

iv) Cell growth factors

The discovery of growth factors in milk has been relatively recent, and their role in immune defence is at present purely speculative. They will be discussed in more detail in future chapters but initial work is summarised here.

Hoerlein (1957) described an increase in specific antibody production in the sera of piglets fed colostrum, compared with those deprived of colostrum. Although the possibility was mentioned that a factor in colostrum might be stimulating or enhancing antibody production, this possibility was not pursued. Again in pigs, Heird and Hansen (1977) recorded an 82% increase in the small intestinal mass during the first 24 hours of life in suckled compared with artificially fed piglets. These workers suggested a growth factor in colostrum for intestinal mucosa, and subsequently, epithelial growth factors have been identified, not only in animal milk (Klagsburn, 1980; Schwartz and Heird, 1981) but also in human milk (Klagsburn, 1978; Tapper, Klagsburn and Neumann, 1979; Carpenter, 1980). These may play a role in defence against infections and allergy by increasing maturation of the gut epithelium, thereby reducing the uptake of potentially antigenic macromolecules.

Factors capable of modulating the immune response have also been detected in human milk and are secreted by milk cells *in vitro*. These include secretory component (Crago *et al*, 1981), lymphokines such as lymphocyte derived chemotactic factor (LDCF), alpha- and gamma-interferon (Emodi and Just, 1974; Keller *et al*, 1981) and prostaglandins E and F (Lucas and Mitchell, 1980). Pittard and Bill (1979a and b) have demonstrated a high molecular weight factor, released by breast milk cells, which stimulated cord blood lymphocytes to produce IgA but not IgG or IgM. The possibility that these factors might be important *in vivo* was an important consideration in the initiation of the present study.

2) Specific factors

Some of the earliest studies on milk, described antibody activity to a number of organisms (Ratner, 1927, as quoted by Nordbring, 1957). We now know that many of these antibodies are produced by lymphocytes in the mammary gland of the mother. Many viable lymphocytes and other leucocytes are also transferred to the infant gut via colostrum and milk. Although not all of these cells are specific in their action, they are included in this section for convenience.

i) Cells

The presence of cells in milk was first described by Donné in 1839, and in 1845 he published a collection of photomicrographs of what he called colostrum corpuscles. These were later shown to be fat-laden macrophages (Smith and Goldman, 1968). Extensive studies on the leucocytes in colostrum have shown between $0.5-10 \times 10^6$ viable cells/ml. These consist of macrophages (80-90%), lymphocytes (5-15%) and a few neutrophils. As lactation becomes established, the cell concentration falls to about one fiftieth of that in colostrum, but because the daily milk volume increases, the total number received by the infant remains large (Lawton and Shortridge, 1977).

a) Macrophages

Milk macrophages are large, amoeboid and highly phagocytic cells, and have many of the features of activated macrophages (Goldman, 1977). They have been shown to phagocytose *Staphylococci*, *E.coli* and *Candida albicans in vitro* and also secrete the complement components C3 and C4, and lysozyme and lactoferrin (Goldman and Smith, 1973). *In-vitro* cultures of macrophages have also been shown to release large quantities of sIgA, suggesting they may have a role in storing this

immunoglobulin (Pittard, Polmar and Fanaroff, 1977; Weaver *et al.*, 1982). They are also capable of interacting with milk lymphocytes (Smith and Goldman, 1970) and responding to lymphokines. Work in rats by Pitt, Barlow and Heird (1977) has demonstrated that macrophages are important in protecting against *Klebsiella*-induced necrotising enterocolitis.

b) Lymphocytes

Colostrum contains approximately 2×10^5 lymphocytes/ml, comprising about 50% T cells and 34% B cells (Diaz-Jouanen and Williams, 1974). These T cells respond to allogeneic lymphocytes in a manner similar to peripheral blood lymphocytes (PBL), but the response to mitogens such as PHA is lower (Parmely, Beer and Billingham, 1976). They also respond to antigens, but compared to PBL there is a greater responsiveness to those antigens found at secretory surfaces such as *E.coli* and tuberculin (PPD) and a lower response to antigens more likely to have been encountered systemically such as tetanus toxoid. This has led Parmely *et al.* (1977) to suggest a separate population of T cells involved in the secretory immune system.

The role of these colostrum and milk T cells in the suckled infant is not known. The lower pH of the newborn infant's stomach may allow survival of viable lymphocytes into the small intestine. Whether these cells can enter the gut tissues or circulation of the infant is not known. In rats, Beer, Billingham and Head (1974) have demonstrated that milk lymphocytes were capable of initiating graft versus host disease in fostered allogeneic recipients. In humans, Mohr (1973) and Schlesinger and Covelli (1977) have shown transfer of tuberculin sensitivity from mother to infant in breast-fed (but not bottle-fed) infants. This could be due to cell transfer but it might

also be due to the transfer of soluble factors. However, other workers have not confirmed these observations (Chandra, 1978). Further evidence that milk cells do not pass into the infants tissues comes from studies in infants with severe combined immunodeficiency disease who are receiving breast milk. These infants have not shown any evidence of graft versus host disease or chimaerism (Ogra, 1979).

The B lymphocytes of human colostrum and milk have been shown to differentiate into plasma cells *in vitro* and secrete IgA (Murillo and Goldman, 1970). Experiments in rabbits (Montgomery, Cohn and Lally, 1973) and later in humans (Goldblum *et al*, 1975) have shown the appearance of antigen-specific B cells in milk following oral challenge with antigen. This suggested a route of migration of lymphocytes from gut to mammary gland, and Roux *et al* (1977) have demonstrated that the B cells of milk do come from a precursor population primed in the gut. The localisation in the mammary gland appears to be under hormonal control (Weisz-Carrington *et al*, 1978).

ii) Immunoglobulins

The predominant immunoglobulin of human milk is sIgA and this occurs in concentrations of up to 100mg/ml in early colostrum. Levels decline rapidly during the first week of lactation to a basal level of 1-2mg/ml (McClelland, McGrath and Samson, 1978). IgM and IgG antibodies also occur in colostrum and milk but the concentrations are only 10% and 3% respectively of those in serum.

The sIgA molecule, first isolated and characterised by Heremans (Heremans, Heremans and Schultze, 1959), consists of two monomeric IgA molecules joined by a J chain (Koshland, 1975). A polypeptide molecule called secretory component (SC) is attached to this dimer as

it passes through the epithelial cells overlying the mucous surfaces (Brandzaeg, 1978). The transfer mechanism of IgA molecules via secretory component receptors on the epithelial cells, seems to depend on the presence of the J chain. The mechanism does not operate for serum monomeric IgA but does operate for IgM, which also contains a J chain. The amino-acid sequences of the heavy chain (α -chain) confer on the IgA molecule several important properties. First, several intra-chain disulphide bridges give more areas of compact folding than other immunoglobulin heavy chains. This appears to be important in rendering the molecule resistant to proteolysis by the enzymes found at many secretory surfaces - particularly the gut. This property is further enhanced by the glycine-rich secretory component. Second, the IgA molecule readily forms disulphide bonds with the mucin glycoproteins, thus forming a tight association with the mucous coat. Third, dimeric IgA from milk (without SC) has been shown to bind to specific receptors on buccal epithelial cells in breast-fed neonates (Roberts, Wincup and Harries, 1980). These receptors are thought to be SC as they are blocked by anti-SC antibodies.

Studies on the stools of breast-fed infants have indicated that over 70% of milk IgA survives transit through the infants' gut (Kenny, Boesman and Michaels, 1967; Ogra *et al.*, 1977). The question of absorption of sIgA by the newborn infant remains controversial and is discussed in more detail in Chapter 6. Whether or not small amounts of IgA are absorbed, it is apparent that the main activity of the milk sIgA is within the gut of the infant, and several antimicrobial mechanisms of sIgA have been investigated.

Anti-adhesive properties have been demonstrated for sIgA from the parotid gland (Williams and Gibbons, 1972) and for colostral and milk antibodies in pigs (Rutter *et al.*, 1976). Antibodies to the pili of *E.coli* have also been demonstrated in human milk (Svanborg-Eden *et al.*, 1979). Agglutinating sIgA antibodies are present in colostrum and milk against many intestinal organisms (McClelland *et al.*, 1972) and it has been suggested that agglutinated organisms may be less able to colonise the gut epithelium (Cantey, 1978). Neutralising antibodies to bacterial toxins (Holmgren *et al.*, 1976; Wada *et al.*, 1980) are present in milk and virus-neutralising antibody activity has been demonstrated against several viruses (Welsh and May, 1979). The activities of sIgA as an opsonin or complement activating antibody are less certain. Lamm (1976) has reviewed several conflicting reports on opsonisation but the decisive factor may be the necessity for IgA receptors to be present on the opsonising cells (Bienenstock and Befus, 1980). Although sIgA aggregates have been shown to activate the alternative pathway of complement *in vitro* (Colten and Bienenstock, 1974), it is not known whether the conditions in the infant gut favour complement activation. However, the presence of all nine components of complement in human milk (Nakajima, Baba and Tamura, 1977) may be of significance in this respect. A bacteriostatic activity of sIgA in combination with lactoferrin has already been discussed. This inhibition appears to be more effective against pathogenic serotypes than commensal strains (Stephens *et al.*, 1981) and this selective inhibition could be important in controlling the growth of pathogens, while allowing establishment of harmless commensal strains.

The activities of sIgA described are primarily effective in limiting attachment or growth of organisms, rather than in killing them. Attachment and growth are both prerequisites for the establishment of an infection and may explain why pathogens such as *Shigella* and enteropathogenic *E.coli* have been isolated from the stools of breast-fed babies in the apparent absence of disease (Mata and Urrutia, 1971).

iii) Specificities of antibodies in milk.

An extensive review of the early literature on the specificities of antibodies in milk is given by Nordbring (1957). These studies used techniques which relied upon secondary properties of antibody molecules such as agglutination and bactericidal activity and therefore favoured the detection of IgG and IgM molecules. Antitoxins to diphtheria and tetanus toxins, antistaphylolysin and antistreptolysin, and agglutinins to *Bordetella pertussis*, typhoid and dysentery bacilli were all found, but with the exception of the enteric organisms (i.e. typhoid and dysentery) the titres in colostrum and milk were always much lower than the titres found in serum. More recent work has shown that specific antibodies to a variety of organisms are present in milk. These organisms include *Clostridium tetani*, *Corynebacterium diphtheriae*, *Diplococcus pneumoniae*, *E.coli*, *Salmonella*, *Shigella*, *Haemophilus influenzae*, *Streptococci*, *Staphylococci*, (Hanson and Winberg, 1972; Hanson *et al*, 1975; 1978; Welsh and May, 1979) and *Bacillus fragilis* (Ste-Marie, Lee and Brown, 1974). Antibodies to microbial toxins from *E.coli* and *V.cholerae* (Stoliar *et al*, 1976) and *Cl.difficile* (Wada *et al*, 1980) have also been demonstrated. Viral antibodies present in milk include antibodies to polio, rotavirus, ECHO, coxsackie, and influenza viruses

(Welsh and May, 1979). Human milk has also been shown to contain antibodies against various food antigens such as cow milk proteins (McClelland and McDonald, 1976).

SECTION C - IMMUNOLOGICAL STATUS OF THE NEONATE I

SYSTEMIC IMMUNITY

In this section the non-specific and specific defences of newborn human infants will be reviewed. Increased susceptibility to infections (compared with adults) suggests that their immune system is deficient in some aspects. The evidence for this will be discussed for both the systemic and local defences. In order to set the infant studies in context, a brief review of adult lymphocyte function will be given and the relevance of the *in-vitro* functional assays available will be discussed.

1) Lymphocytes and their function.

Lymphocytes are derived from haemopoetic stem cells in the adult bone-marrow. Their central role in immune responses was demonstrated by Gowans (1959) who showed, by cannulation of the thoracic duct in rats, that they were part of a recirculating pool of cells, which when depleted, caused loss of immune competence. Subsequent work has distinguished two major populations of lymphocytes, one which differentiates under the influence of the thymus (T cells) and the other which differentiates under the influence of the bone-marrow (B cells).

T cells are important in cell-mediated immunity and in modulation of immune responses. Several sub-populations of T cells have been described according to function. These include helper or inducer, suppressor, cytotoxic and delayed type hypersensitivity T cells. In fact these sub-populations can be further sub-divided, for example at least two types of T helper cells may act during induction of the immune response (Reinherz *et al*, 1981), while different T helper cells may stimulate different classes of immunoglobulin (Lum, Benveniste and Blaese, 1980). T cell subsets can be distinguished to some degree by surface markers. In the mouse, these markers have been well characterised (Cantor, 1979). In the human, subsets can be distinguished by monoclonal antibodies such as OKT4 and OKT8, but the surface molecules against which these antibodies are directed have yet to be characterised. However, whether these subsets of T cells are distinct and separate populations, or whether they are capable of changing function under different conditions remains unclear (Eardley, Staskawicz and Gershon, 1976; Farrant and Knight, 1979).

The B cell population is important in humoral immunity. Most B cells can be distinguished by the presence of immunoglobulin on the surface membrane. After stimulation with antigen, the cells bearing Ig receptors for that antigen will proliferate and/or differentiate into immunoglobulin secreting cells. For most antigens, T cell help and monocytes are also necessary (T-dependent antigens), but some polysaccharide antigens can elicit antibody production in the absence of T cells (T-independent antigens). A review of tests for assessing immune status is given in a report on Immunodeficiency (Chandra *et al*, 1978). Some of the *in-vitro* functional assays used in this study are outlined below and will be discussed further in Chapters 4 and 5.

2) *In-vitro* tests of lymphocyte activation and function.

The study of lymphocyte activation and function *in vitro* using specific antigens presents difficulties, particularly in non-immune donors, since such a small number of cells are specific for any one antigen. Several plant lectins and other compounds have been found to induce polyclonal stimulation of particular types of lymphocytes, and these have been extensively used in studies on lymphocyte activation and function *in vitro* (Greaves and Janossy, 1972). A limitation of these polyclonal activators is that none of them act on one cell population only. Different activators can, however, be used to study T cell proliferation (e.g. phytohaemagglutinin - PHA), T helper cell function in antibody production (pokeweed mitogen - PWM), and B cell proliferation and function (Epstein-Barr Virus - EBV, and bacterial extracts from organisms such as *Staph. aureus* and *Nocardia*).

i) Phytohaemagglutinin (PHA)

Soluble PHA has been shown by some workers to activate T cells only (Rich and Pierce, 1973), although when it is bound to plastic, B cells are also activated. However, others have indicated B cells may also be stimulated to proliferate (Shankey, Danielle and Nowell, 1981). PHA stimulated T cells produce soluble mediators (lymphokines) which in turn will act on other cell populations. The magnitude of the proliferative response varies widely with the dose of PHA (Rich and Pierce, 1973).

ii) PWM

Pokeweed mitogen (PWM) stimulates both T and B cells to proliferate. Peripheral blood B cells are activated in a T dependent manner, that is they will not proliferate or differentiate in the absence of T

cells (Keightly, Cooper and Lawton, 1976). Under optimal conditions, PWM stimulated B cells will secrete immunoglobulin *in vitro*, but the response is dependant on mitogen dose, T:B cell ratios and cell concentrations (Janossy *et al.*, 1977). Monocytes are also necessary, although too many can be inhibitory (Montazeri *et al.*, 1980; Gmelig-Meyling and Waldman, 1981). Cells responding to either PHA or PWM appear to be distinct rather than the different mitogens affecting similar cells in different ways (Greaves and Janossy, 1972).

iii) *Staph.aureus* (Cowan) (SAC)

Several bacterial components have been found to be mitogenic for B cells (Banck and Forsgren, 1978; Waldmann and Broder, 1982) including a strain of *Staph.aureus* (Cowan I) (SAC) with a high content of Protein A. This bacterium activates B cells and macrophages, with B cells being stimulated to secrete immunoglobulin. Pryjma *et al* (1980) demonstrated that although Ig production in PWM and SAC was comparable, only SAC was active in cultures depleted of T cells. This stimulation was also resistant to influence by suppressor cells generated by co-stimulation with concanavalin A. This indicates that stimulation by SAC may be less thymus dependent than PWM.

iv) Allogeneic lymphocytes

When mixtures of allogeneic lymphocytes are co-cultured, cells of both populations will proliferate in response to the foreign histocompatibility antigens on the surface of the other cells. Mitomycin-C treatment of one population will prevent proliferation of the treated cells, but still enables them to stimulate the other population to respond. This reaction is termed a one-way mixed lymphocyte reaction (MLR). Blastogenic factors are produced during

this response, but proliferation is not essential to their appearance as the factors are still produced even when both populations are treated with mitomycin-C (Hirschberg, Rankin and Thorsby, 1974). Although the response has been shown to be due to proliferation of T cells, B cells and antigen-presenting cells are more effective stimulators in the MLR (Kuntz, Innes and Weksler, 1976; Horwitz and Garrett, 1977).

v) Specific antigen

Specific antigens such as tetanus toxoid, Candida, PPD and influenza virus will induce proliferation in lymphocytes from immune donors, but not in non-immune donor cells (Leiken and Oppenheim, 1970; Alford, Cartwright and Sell, 1976; Callard, 1979). In a tetanus toxoid induced system, Geha, Mudawwar and Schneeberger (1977) demonstrated that factors were produced which could also stimulate autologous and heterologous B cells in a non-specific manner, resulting in a polyclonal proliferation subsequent to the specific induction. As with the PWM system, immunoglobulin and specific antibody production *in vitro* require optimal concentrations of T and B cells and monocytes.

3) Ontogeny of circulating lymphocytes.

In the human foetus, stem cells start to enter the thymus by the eighth week of gestation. By the 10th week, thymic cells respond to PHA *in vitro*, and spleen and blood cells respond 3-4 weeks later (Jones, 1968; August *et al*, 1971; Stites and Pavia, 1979). Responsiveness to allogeneic lymphocytes (MLR) can be found in foetal liver cells from 7.5 weeks gestation. These MLR responsive cells are not responsive to PHA, suggesting that different populations of T

cells respond to the two stimuli (Carr, Stites and Pudenberg, 1973).

B cells can be found in the foetal liver from 8 weeks gestation; from 9-10 weeks these have surface IgM receptors and IgG receptors can be detected shortly afterwards. By the beginning of the second trimester, the foetus has adult proportions of B cells expressing the different classes of immunoglobulin (Gotoff, 1974; Lawton and Cooper, 1979). Cultures of foetal tissues indicate that lymphocytes start to secrete IgM spontaneously between 10-12 weeks gestation, IgG by 12 weeks but IgA is not detected in tissue cultures before 30 weeks, although some has been detected in foetal serum (Gitlin and Biasucci, 1969). The techniques used by these workers, however, were only sufficiently sensitive to detect 2 μ g/ml or more of IgA. This low level of foetal immunoglobulin synthesis of all classes is not thought to represent a functional deficiency but rather a lack of antigenic stimulation, since intrauterine infections can cause production of large quantities of IgM and smaller quantities of IgG and IgA *in utero* (Alford *et al*, 1967; McMurray and Rey, 1981).

4) Immune function of the neonate at birth. Studies on cord blood.

The anatomy of the immune system is fully developed by parturition. However, it is antigenically inexperienced and functionally deficient (Stiehm, Winter and Bryson, 1979). The efficiency of the placenta results in most infants receiving little antigenic stimulation *in utero*. The birth process and the ensuing contact with the external environment results in a massive onslaught of antigenic material, not the least of which arises from the colonisation of the gut with normal flora, which happens within hours of birth. Reduced immune responses suggest that the intact immune

system is functionally deficient and several studies have indicated that this is the case.

i) Cell-mediated immunity

Cord blood lymphocytes (CBL) have a higher rate of background proliferation than adult cells during *in-vitro* culture, and incorporate 6-10 times more isotope. When stimulated with low doses of PHA, the responses of CBL are significantly greater than adult PBL (Eife *et al.*, 1974), although at higher doses of PHA the responses are comparable (Carr, Stites and Fudenberg, 1972). These differences can be explained by the demonstration that the optimal stimulating dose of PHA is higher for adult cells, but the maximal proliferation at optimal PHA dose is considerably higher in CBL (Ben-Zwi *et al.*, 1977). The proliferative response of CBL's also occurs more rapidly than that of adult cells (Yoffey *et al.*, 1978). Total lymphocyte concentration in cord blood is higher than adult blood, although the proportion of T cells is lower (Davis and Galant, 1975; Diaz-Jouanen, Strickland and Williams, 1975; Ben-Zwi *et al.*, 1977). Proliferative responses to allogeneic lymphocytes (MLR) are comparable to adult levels (Stiehm, Winter and Bryson, 1979). However, the delayed type hypersensitivity reaction is diminished and the proliferative response to antigens is lower (Leiken and Oppenheim, 1970; Alford, Cartwright and Sell, 1976). Cell-mediated lympholysis is also reduced (Stiehm, Winter and Bryson, 1979).

In addition to proliferative responses, stimulated T cells and macrophages may also secrete factors (lymphokines) which are capable of modulating immune responses. In CBL cultures, production of macrophage migration inhibition factor (MIF) is reduced (Winter *et al.*,

1978) but lymphocyte migration inhibition factor production is comparable to adult levels (Stiehm, Winter and Bryson, 1979). Lymphotoxin production has been reported at only 40% of adult levels (Eife *et al*, 1974). Natural (α -) interferon production has been reported as normal (Gotoff, 1974) but gamma-interferon production is reduced (Stiehm, Winter and Bryson, 1979; Taylor and Bryson, 1981). The latter workers attributed this to a functionally immature macrophage.

Cord blood macrophages have also been shown to be deficient in their ability to phagocytose polystyrene spheres (Schuit and Powell, 1980). However, Zlabinger, Mannhalter and Eibl (1983) have found neonatal macrophages to be mature with regards to surface Ia expression, release of interleukin I and presentation of antigen.

Several studies have indicated that the MLR between maternal and infant lymphocytes is depressed in comparison with paternal and infant cells. This is particularly apparent when the infant cells are the stimulators (Field and Caspary, 1971; Lawler, Ukaejiofo and Reeves, 1975; Toivanen and Granberg, 1980). The mechanism of this suppression is not known, although it is thought to be due to foetal T suppressor cells (Toivanen and Granberg, 1980) and may be important in the protection of the developing foetus.

ii) B cell responses and immunoglobulin production *in vitro*

There are several possible reasons why immunoglobulin production is lower in the neonate. First, the appropriate T or B cells may be absent; second, the B cells may be immature; third, there may be a lack of help (from T cells or macrophage interactions) and fourth, there may be an excess of suppression. In a PWM driven system,

Hayward and Lawton (1977) demonstrated that CBL's generated fewer plasma cells than adult PBL's, and the response was almost exclusively IgM. Using T/B separation techniques, they showed that adult T cells enhanced antibody production in cord blood B cells, particularly for IgG and IgA classes, but newborn T cells were not as efficient at helping adult B cells. This suggested a helper T cell deficiency in newborns, with T cells generally balanced towards suppression. Other workers have also found newborn T cells to be inefficient helpers (Andersson, Bird and Britton, 1980; Miyagawa *et al*, 1980), although yet others have suggested a B cell immaturity is also responsible (Hayward and Lydyard, 1979; Ferguson and Cheung, 1981). Leiken and Oppenheim (1970) suggested a lack of antigen specific B cells was responsible for the deficient proliferative response to the antigen tetanus toxoid.

The reduced immune responses of neonates are the result of complex interactions of cell populations which are maturing at different rates. The functional immaturities of helper and suppressor T cells, B cells and monocytes are all critical factors. The role of monocytes has been less thoroughly investigated but there are suggestions that their role may be more critical in neonates than in adults (Hutchins and Steele, 1983).

iii) Immunoglobulins in cord blood

Although foetal Ig synthesis is low and is largely of the IgM class, maternal IgG is transported across the placenta to the foetus. This occurs passively from about the 15th week of gestation and actively during the last trimester (Larsen and Galask, 1977). At term the foetal blood has 10-15% more IgG than maternal blood, with a

concentration between 10-15mg/ml (Kohler and Farr, 1966; Allansmith *et al*, 1968). Not all subclasses of IgG cross the placenta to the same extent and transport of IgG2 is lower than other subclasses. Nevertheless the specificity of maternally acquired IgG represents the antigenic exposure of the mother. Examination of allotypic (Gm) markers has indicated that the contribution of foetal IgG is minimal in cord blood (Martensson and Fudenberg, 1965). IgM concentrations in cord blood are about 10% of adult levels (100µg/ml) and IgA concentrations are only about 0.1% (1-2µg/ml), a level which is frequently below the threshold of the less sensitive techniques such as radial immunodiffusion (Berg, 1969).

iv) Non-specific immunity, neutrophils.

Cord blood neutrophils have immature nuclear morphology but can phagocytose and kill *Staph.aureus* and *E.coli* at rates approaching those of adult cells. However opsonising antibodies (IgM) and complement are low in cord blood and this results in a general defect in phagocytosis (Dosset, Williams and Quie, 1969). Neutrophils also migrate less well than adult cells, both randomly and chemotactically.

5) Changes in immunity with age.

i) Immunoglobulin levels

Maternal IgG is catabolised by the infant with a half-life of 25-30 days (Wiener, 1951). Levels decline over the first few months of life, and reach their nadir between 3-6 months at 4-4.5mg/ml. After this time, infant IgG secretion is greater than maternal IgG catabolism, and by 1 year concentrations are about 6mg/ml (Stiehm and Fudenberg, 1966; Berg, 1969). Adult IgG levels are reached by 11-12 years of age (Berg and Johansson, 1969) or earlier (Buckley, Dees and

O'Fallon, 1967; Allansmith *et al*, 1968).

There have been several reports that maternal antibodies may exert a suppressive effect on neonatal immune responses (Cooke and Jones, 1943; Peterson and Christie, 1951). The latter workers found that the responses to pertussis and diphtheria vaccination were significantly lower in infants with maternally acquired specific antibodies but did not find this inhibitory effect for tetanus toxoid vaccination. Inhibition may be overcome by increasing the dose of antigen (Miller, 1980).

IgM concentrations rise fairly rapidly during the first few weeks of life and then more steadily (Stiehm and Pudenberg, 1966; Berg, 1969). This period of rapid increase corresponds with the colonisation of the gut with micro-organisms. By the end of the first year of life, IgM concentrations have reached approximately half adult levels (540 μ g/ml, Stiehm and Pudenberg, 1966; 700 μ g/ml, Berg, 1969). Adult levels are reached by 4 years of age (Berg and Johansson, 1969) or earlier (Buckley, Dees and O'Fallon, 1967).

IgA concentrations rise steadily during the first year to approximately 300 μ g/ml (Stiehm and Pudenberg, 1966; Haworth and Dilling, 1966; Berg, 1969) but do not reach adult concentrations until puberty (Allansmith *et al*, 1968; Berg and Johansson, 1969).

Several studies have indicated that increased exposure to antigens results in higher concentrations of all classes of immunoglobulins. Berg, (1969) compared children with recurrent infections with those remaining free from infections during the first year and found significantly higher immunoglobulins, particularly of

the IgM and IgA classes, as early as 3 weeks of age. Gerrard *et al.*, (1977) compared Ig levels in white and Cree Indian communities in Saskatchewan, and found the Indian community, with greater exposure to infectious agents, had significantly higher levels of IgG, IgM, IgD and IgA.

ii) Lymphocyte function *in vitro*

Although the development of serum immunoglobulin concentrations has been well studied in healthy infants, very few comprehensive studies have been performed on the progressive development of lymphocyte function *in vitro*. Alford, Cartwright and Sell (1976) have studied proliferation of infant lymphocytes from birth to 20 months. They showed that unstimulated and PHA stimulated proliferation was higher than that of CBL during the first few months of life, but had declined to adult levels by 20 months. Proliferative responses to antigens such as streptolysin and *Candida* were lower when account was taken of the high background proliferation. Andersson, Bird and Britton (1981) have made a sequential study of B lymphocyte function in infants from birth to 2 years of age. Using EBV, which is a T independent activator of B cells, they found that IgM was secreted at adult levels from birth, but IgG secretion was deficient until 2 years of age, with G2 and G4 subclasses being slower to mature than G1 and G3. Using PWM, a T-dependent B cell activator, immunoglobulin was not secreted at all until after 6 months of age, due to an immaturity of T helper cells.

Lymphokine production is also variable. Winter *et al* (1978) have shown that the deficiency of gamma-interferon production lasts beyond the first week of life, although classical interferon production at 1

week was normal. However, Keller *et al* (1983) demonstrated that infants less than 1 week of age were able to produce adult levels of leucocyte derived chemotactic factor (LDCF) in response to mitogen.

SECTION D - IMMUNOLOGICAL STATUS OF THE INFANT II

LOCAL IMMUNITY

The existence of a separate secretory immune system was first suggested by Hanson (1961), and since then several studies (Tomasi *et al*, 1965; Heremans, 1975; Bienenstock, 1974) have established the local immune system as a unique protective process present at all epithelial surfaces in direct contact with the environment (e.g. intestine, bronchial tree, and genitourinal tract). This local system is independent of systemic immune responses and is stimulated by antigen at mucosal surfaces.

1) Gut associated lymphoid tissue (GALT) and Lymphocyte pathways.

Lymphoid tissue belonging to the secretory immune system underlays all mucosal epithelia and is found in the stroma of all external glands. The heaviest concentrations occur in the gut, in Peyer's patches and throughout the lamina propria, which is the site of the heaviest antigenic load. Crabbé and Heremans (1966) demonstrated that plasma cells in these tissues were secreting primarily IgA; this contrasts with IgG which was produced by plasma cells in other lymphoid tissues such as spleen and peripheral lymph nodes.

The newborn infant is virtually devoid of a functionally differentiated immune system in the gut during the first week of life (Haneberg and Aarskog, 1975) due to lack of antigenic stimulation *in utero*. However, colonisation of the gut with micro-organisms and ingestion of food antigens soon after birth results in a fairly rapid development of local lymphoid tissues and appearance of sIgA by 2-4 weeks post-partum (Selner, Merrill and Claman, 1968).

Gowans and Knight (1964) showed in rats that thoracic duct lymphocytes, when adoptively transferred, returned primarily to the small intestine of the recipients. Subsequently, repopulation experiments have shown that Peyer's patches contain a precursor population of cells largely destined to make IgA in the intestine several days after transfer (Craig and Cebra, 1971). The exact route of migration of these cells is not clear but the mesenteric lymph nodes (MLN) are thought to be important in the IgA cell cycle (Husband and Gowans, 1978; Roux *et al.*, 1979). Similar properties of lymphoid tissue of the bronchus, together with repopulation studies, has led Bienenstock (1974; Bienenstock and Befus, 1980) to suggest a common mucosal associated immune system (MALT).

The factors controlling the mucosal localisation of the precursor cells are largely unknown. Secretory component was thought to be important but does not now appear to be (Bienenstock and Befus, 1980). Hormones can affect migration to certain locations such as the mammary gland, cervix and vagina (Weisz-Carrington *et al.*, 1978) but are not always involved at other sites (McDermott, Clark and Bienenstock, 1980). Antigen seems to amplify the localisation of the cells but is not essential as localisation still occurs in the absence of antigen

(Pierce and Gowans, 1975). The role of chemotaxis has yet to be determined (Parrot, 1979). Kawanishi, Saltzman and Strober (1983) have demonstrated in mice, the presence of a T cell in Peyer's patches which stimulated surface IgM bearing cells to differentiate into surface IgA bearing cells. This T cell could not be demonstrated in cultures of spleen cells. Whether these T cells have any effect on B cell localisation is not known.

2) Secretory immunoglobulins

The structure and properties of the IgA molecule which make it particularly suited to the secretory surfaces have been discussed previously (Section B2ii). The quantities of immunoglobulins in the secretions of newborn infants are very low. Haworth and Dilling (1966), using radial immunodiffusion, could not detect IgA in saliva before 2 weeks of age, but showed that detectable levels did occur in saliva before serum, and that the salivary and serum IgA levels were not correlated. Selner, Merrill and Claman (1968) noted that IgA in saliva rose rapidly during the first few weeks of life. They suggested that salivary IgA reached adult levels within 2-3 months, however more recent work using improved electroimmunodiffusion techniques for detecting sIgA, has indicated that adult levels are not reached until 6-8 years (Burgio *et al*, 1980).

Secretory IgA is also the predominant immunoglobulin at most other secretory sites, although IgG may also be present in similar quantities at sites such as the nasopharynx (Cohen, Goldberg and London, 1970) and duodenum (Lebenthal, Clark and Kim, 1980). Specific antibodies to a number of organisms have been demonstrated, especially to those colonising the gut and other surfaces (Shearman, Parkin and

McClelland, 1972; Welliver and Ogra, 1978; Sohl-Akerlund *et al*, 1979). The relative deficiencies of these antibodies during the first few months, at the sites of highest antigenic load including the mouth and the rest of the gastrointestinal tract, highlights the potential importance of the IgA contained within breast milk.

3) Local non-specific defence mechanisms

In addition to the specific cell-mediated immunity and antibody production, the infant is also endowed with a number of non-specific defence mechanisms. Many of the non-specific antimicrobial factors found in milk (described above) are also present at other secretory surfaces. These include lactoferrin and enzymes such as lysozyme and lactoperoxidase (Gotheffors and Marklund, 1975). Non-specific factors controlling the development of normal gut flora and limiting the growth of potential pathogens have been reviewed (Borriello and Stephens, 1984). The acid pH of the stomach is certainly an important defence factor in adults, although in newborn infants the stomach appears to have a higher pH (Miller, 1941; Agunod *et al*, 1969). Mucins (glycoproteins and glycolipids) in the mucous coat may act like the receptor analogues of milk (Section B1i) and limit the attachment of micro-organisms. Organisms which cannot adhere are more easily removed by mechanisms such as peristalsis in the gut and the ciliary movement of the upper respiratory tract. The importance of the normal gut flora in defence has already been discussed (Section B1i). In addition to the mechanisms described, there is also evidence that the normal gut flora is essential for the development of the gut lymphoid tissue, since in gnotobiotic animals reared in a sterile environment, there is considerable reduction in gut lymphoid tissue (Ottaway, Rose and Parrot, 1979).

SECTION E - EFFECT OF DIET ON IMMUNITY

Although no comprehensive studies have been conducted on immunity in infants reared on different but nutritionally adequate diets, there have been many studies on the effect of undernutrition on immunity. These will be briefly reviewed in order to emphasise the important effects food (or lack of it) can have on the development of the immune system. Direct effects are often difficult to determine as malnutrition and infections frequently occur together. There have been many studies on various aspects of protein-calorie and single nutrient deficiencies. These are reviewed by Chandra (1980) and Dowd and Heatley (1984).

In protein-calorie malnutrition, cell-mediated immunity seems to be more severely affected than humoral immunity. There is a reduction in lymphoid anatomy at all sites (thymus, spleen, lymph nodes, total circulating lymphocytes). Most T cell functions are reduced, such as delayed cutaneous hypersensitivity, immunity to intracellular organisms, responses to T cell mitogens and lymphokine production. However B cell function is more variable. Serum immunoglobulin levels are often raised, usually due to repeated infections or increased uptake of food and other gut associated antigens (Chandra, 1975). B cell numbers may be normal or reduced, and response to mitogens such as PWM are increased. However, both specific antibody responses and secretory immunoglobulins are decreased. Non-specific immunity, such as phagocyte function or complement levels may be normal or decreased. Single dietary deficiencies which also impair immune responses are iron, zinc, folate and vitamin B₁₂, vitamin C, vitamin A and pyridoxine (Chandra, 1980).

SECTION F - PLAN OF THESIS

Existing evidence for the role of milk in passive protection in the infants gut is now fairly conclusive. The implications that milk may also have an active role in development of immunity in the infant comes from the prolonged resistance to infection beyond the weaning period, the increased resistance to systemic as well as gastrointestinal infections, and the increasing evidence for the presence of lymphokines and other growth factors in milk.

The aim of this study was to use a range of tests for cell-mediated and humoral immunity to determine whether the maturation of the infants immune defences, which normally occur during the first few months of life, were being enhanced or modulated in any way by breast milk. The protocol chosen for this was as follows:-

- 1) Subjects - 30 infants chosen for study;
 - a) 15 completely bottle-fed
 - b) 15 breast-fed, with records of supplements
- 2) Age at which samples were taken - Infants studied on five occasions;
 - a) 6 days
 - b) 6 weeks
 - c) 3 months
 - d) 6 months
 - e) 9 months
- 3) Samples -
 - a) blood (heparinised and clotted)
 - b) saliva.

4) Tests on serum and secretions for estimation of immune function *in vivo*;

a) total IgG, IgM and IgA

b) specific antibodies to tetanus toxoid (G, M and A)

c) specific antibodies to commensal *E.coli* (G, M and A)

5) Tests on lymphocytes for estimation of immune function *in vitro*;

a) lymphocyte proliferative responses to PHA, PWM, SAC, MLR and TT

b) production of immunoglobulins and specific antibodies.

CHAPTER 2

MATERIALS AND METHODS

SECTION A - SUBJECTS AND SAMPLES

1) Selection of infants

Full-term healthy infants were recruited to the study with full parental consent. Mothers were informed about the study by antenatal clinic counsellors or National Childbirth Trust volunteers during pregnancy, or by the author during their first 4 days post-partum. The choice of breast- or bottle-feeding was left entirely to the mother and no pressure was exerted on the mothers to prolong breast-feeding because of the study. Twenty-nine of the thirty infants were born at Northwick Park Hospital (NPH), infant 03 was born at Schrodells Hospital, Watford. All families lived in the Harrow or Watford area. Breast-fed infants were selected from families highly motivated to succeed at breast-feeding, and many had successfully breast-fed a previous infant. Bottle-fed infants were selected from families who had decided pre-partum to bottle-feed, so that the infants were not put to the breast at any time. An attempt was made to select families who seemed most likely to complete the 9 month study period and to be reliable in recording methods of feeding, intercurrent infections etc.. For this reason, mothers with a poor understanding of English, those felt by the nursing staff to be 'unreliable', and anyone slightly hesitant about volunteering were excluded from the study. One mother (of infant 21) withdrew from the study after the first visit.

During the study, mothers were encouraged to approach the NPH paediatricians with any problems, however minor, that they had with the infants.

2) Visits and Questionnaires

Infants were studied on 5 occasions, at 6 days, 6 weeks, 3, 6 and 9 months. The first visit was planned to coincide with the Guthrie Test, for most infants this visit was in the Maternity Unit at NPH. Most other visits were at the families' home, but on a few occasions infants were brought to the Day Care Unit in the Out Patient Department. A questionnaire was filled out for each infant. This included details of maternal age, duration of pregnancy and any associated problems, paternal occupation, number of siblings and their feeding group with duration of breast-feeding, and infant sex and birth weight. Mothers were asked to keep a record of any infections the infants contracted, whether these were treated, and any vaccinations they received. This information was recorded on the questionnaire at each visit together with feeding details such as formula type (SMA Gold Cap or Ostermilk Complete Formula), supplements of breast-fed infants with cow milk products, inclusion of cereals and other solids in the diet, and details of weaning. All mothers were asked to avoid feeding the infants, if possible, for at least 2 hours before each visit in order to minimise contamination of saliva samples with breast milk immunoglobulins.

3) Collection of samples

Blood samples (1-5ml) were collected at each visit by a Paediatrician from NPH (see acknowledgements). This was usually done by venepuncture from the antecubital fossa, volar surface of the forearm or dorsum of the hand. In a few cases heel-prick samples were used. Samples for cell studies were mixed with preservative-free heparin (20 units/ml blood), and processed on the day of collection. Total cell counts were performed on duplicate dilutions in Isoton II azide-free balanced electrolyte solution (Coulter Electronics) in the Haematology Department at NPH using a Coulter Counter (Model S-plus IV, Coulter Electronics, Florida, U.S.A.). Films for differential WBC counts were stained with May-Grunwald and giemsa stain in the Haematology Department but counted by the author.

Samples for serology were collected into 600 μ l capillary blood serum separators (Microtainer, Becton-Dickinson, Wembley, Middx.). Once clotted, these samples were spun at 15000 x g (Eppendorf Microfuge), and the serum removed and stored at -70°C. Aliquots for immunoglobulin assays by nephelometry were stored at 4°C.

Saliva specimens were collected by placing a polyvinyl catheter (blue line umbilical cannula 6FG, Portex Ltd., Hythe, Kent) under the tongue and applying gentle suction. Samples were stored at -70°C, either undiluted or the catheter was washed out in 200 μ l phosphate buffered saline (PBS).

SECTION B - MATERIALS

1) Phytohaemagglutinin (PHA)

PHA (Wellcome Laboratories) 10mg/ml, was diluted to 2mg/ml in sterile saline and stored in 200 μ l aliquots at -70°C. The same batch was used throughout. Thawed aliquots were diluted to 20 μ g/ml for use, which gave a final concentration of 1 μ g/ml in the cell cultures. Diluted PHA was kept at -70°C for up to 1 week only.

2) Pokeweed mitogen (PWM)

PWM (Sigma, London) was reconstituted in sterile saline to 2mg/ml and stored as described for PHA. It was used at a final concentration of 1 μ g/ml in the cell proliferation studies.

3) Tetanus toxoid (TT)

Immunopurified TT (14mg/ml, approximately 7000 Lf units/ml) was kindly supplied by Dr R.O.Thomson, Wellcome Foundation, Beckenham, Kent. For the radioimmunoassay (RIA), it was diluted to 250Lfu/ml (500 μ g/ml) in PBS and stored at -70°C. For cell culture work it was diluted to 40ng/ml (0.02Lfu/ml) in Iscove's modified Dulbecco's medium (IMDM) and stored at -70°C.

4) Preparation of mitogen from *Staphylococcus aureus* (SAC).

The method of Banck and Forsgren (1978) was used. *Staph. aureus* Serotype I (Cowan), NCTC 8503, was obtained from the National Collection of Type Cultures (Central PHL, Colindale Ave., London). Organisms were cultured overnight at 4°C in 100ml of brain heart infusion broth (Oxoid) containing 1% proteose peptone, spun and killed

by resuspending in 60ml 0.5% formaldehyde and leaving at room temperature (RT) for 3 hrs. Bacteria were heat-treated for 3mins at 80°C, washed 3 times in PBS, resuspended 1:10 v/v in RPMI 1640 (Flow Laboratories) with bicarbonate (2 g/L, pH 7.4) containing penicillin (100 I.U./ml), streptomycin (100µg/ml) and L-glutamine (2mM/ml), and stored at -70°C. Sterility was checked by culture on blood agar plates (Oxoid).

5) Preparation of *E.coli* 'O' lipopolysaccharide (LPS) antigen

This pool of antigens was used in specific antibody assays of serum and secretions and in preparation of the anti-*E.coli* standard serum (Section D1i). Antibody production to a pool of six commensal strains was used as a paradigm of responses to non-pathogenic organisms encountered as part of the normal gut flora. Six commensal strains of *E.coli*, commonly isolated in the London area, were supplied by Dr. B. Rowe (Central P.H.L.S., Colindale). Their serotypes were O1K1H7, O2K1H4, O4K3H5, O6K2acH1, O15K14H4, O75K?H5. The strains were subcultured on to Columbia agar plates (Oxoid), incubated overnight at 37°C, harvested into saline (0.85%), and adjusted to 12×10^8 orgs/ml. A crude extract of 'O' LPS was prepared by boiling the suspensions for 2hrs and centrifuging at 5000 x g for 30mins; the supernatants were pooled and stored at -70°C.

6) Preparation of stimulator cells for mixed lymphocyte reaction (MLR)

Stimulator cells were mitomycin-C treated before aliquotting and freezing in order to obtain a uniform preparation which could be rapidly reconstituted for each assay.

i) Cell culture

A heterozygous B cell line, Cla-4, was obtained from Dr A. Levin (CRC). The tissue type of this line was A2,29; B12,27; Cw1; Bw4; DR7,DR3. Cells were rapidly thawed from liquid nitrogen by the following method. The ampoule was placed in a 37°C water bath until the cell pellet had almost completely thawed. Culture medium (50% RPMI 1640 with bicarbonate, 50% Eagles MEM (Flow), plus added pen/strep and L-glutamine) containing 20% foetal calf serum (FCS) was added dropwise over a period of 5 minutes, to give a final volume of 10ml. The cells were transferred to a 250ml tissue culture flask (Nunc) and incubated in a humid 37°C incubator containing 5% CO₂. Cells were fed every 2-3 days with medium containing 10% FCS, to give approximately double the volume. Cultures were split into fresh flasks when the volume reached 40ml.

ii) Mitomycin-C treatment

Approximately 600ml medium containing 1×10^6 cells/ml was pooled and spun at 1000rpm for 10 mins in 50ml conical tubes (Falcon Plastics). Pellets were resuspended and pooled in a total of 30ml RPMI 1640 with HEPES (20mM, pH 7.2). To this was added mitomycin-C (Sigma) to give 40-50µg/ml cell suspension (3ml of 500µg/ml solution). Suspensions were incubated 30mins at 37°C, and washed 3 times in RPMI 1640 with HEPES. Cells were resuspended in RPMI 1640 with Eagles containing 5% DMSO to a final concentration of approximately 100×10^6 cells/ml.

iii) Freezing of stimulator cells

Cell suspensions were dispensed into cooled cryotubes (Nunc Plastics) in 100µl volumes (i.e. 10×10^6 cells/vial). Tubes were placed in a glycerol bath at -30°C for 30mins and then rapidly transferred to

liquid nitrogen. Two batches of cells were necessary to complete the study, these batches gave very similar results when set up in parallel in an MLR. Viability of thawed vials was checked with trypan blue and was between 60-70%.

SECTION C - CELL CULTURES

1) Serum free culture medium for proliferation experiments

For mononuclear cell proliferation studies, Iscove's Modified Dulbecco's Medium (IMDM) from Flow Laboratories was used. IMDM powder was reconstituted in distilled water and bicarbonate (15.12g/5L, pH 7.4) added. The medium was filter sterilised at 37°C through a warmed filter (maximum volume 5L) in order to allow maximal penetration of lipid through the filter.

2) Serum-free medium for *in-vitro* immunoglobulin production

Although the above medium supported good proliferative responses with all stimulants used, the lipid content was found to be unsatisfactory for specific antibody production *in vitro* (Farrant *et al*, 1984). For these cultures, supplements of transferrin (TF), bovine serum albumin (BSA) and soy lipid were added to the basic IMDM according to the method of Iscove and Melchers (1978) as described by Farrant *et al*, (1984).

i) Basic medium

IMDM powder (Gibco) containing L-glutamine and 25mM HEPES buffer was made up to 1 litre according to the manufacturers instructions using pyrogen free water (Travenol Laboratories Ltd., Norfolk), and 3.024g

NaHCO_3 (Analar), taking care to protect it from the light. Medium was sterilised by filtration through a $0.22\mu\text{m}$ filter and stored in 20ml volumes in the dark at 4°C . The osmolarity of the medium was checked as 280 mOsmolar, and the pH was 7.2 after equilibration with 10% CO_2 .

ii) Transferrin

Substantially iron-free TF (Sigma, London) was 30% saturated with iron as follows. A 4mg/ml solution of ferric chloride was made using 0.1M HCl diluted in pyrogen-free water. To 100mg TF was added 1.06ml basic IMDM containing Pen/Strep 100I.U./ml and $50\mu\text{l}$ of the ferric chloride solution.

iii) Delipidated Bovine serum albumin

BSA (Behring Institute) was delipidated as follows. Dextran T40 (200mg, Pharmacia) was dissolved in 200ml pyrogen-free water, 2g activated charcoal (Norit-OL, BDH) was added, mixed and left at RT 30mins with occasional agitation. BSA (10g) was added to this and left to dissolve with a minimum of stirring. The pH was adjusted to 3.0 by dropwise addition of N/10 HCl with stirring. The mixture was then heated to 56°C for 30mins with frequent agitation. Charcoal was partially removed by centrifugation at 2700g for 20mins. The supernatant was adjusted to pH5.5 using N NaOH and the remainder of the charcoal was removed by passing the supernatant successively through $1.2\mu\text{m}$ and $0.45\mu\text{m}$ filters. To deionise the BSA, 20ml Amberlite monobed resin MB-1 (BDH) was added, the mixture stirred and left overnight at 4°C . The BSA was concentrated to 50ml (i.e. 20%) over an Amicon PM10 membrane, adjusted to pH7.0 with N HCl, sterilised by passing through a $0.22\mu\text{m}$ filter, aliquotted and stored at 4°C .

iv) Soybean lipid

Soybean lecithin (PH75, Natterman Chemie GMBH, 5000 Koln 30, Germany), 30mg, was weighed into a 25ml beaker (30mm wide x 45mm deep). To this was added 20ml IMDM without added bicarbonate (pH6.8 adjusted with NaOH) containing Pen/Strep and 1% delipidated BSA. The beaker was packed in ice and the lipid sonicated at maximum amplitude using a 1cm probe (MSE soniprobe) for 5mins. The sonicated lipid was sterilised using a 0.22 μ m filter, aliquoted and stored at 4°C. Supplements were added immediately before use; to 20ml basic IMDM was added 400 μ l BSA, 400 μ l soybean lipid and 5 μ l TF to give final concentrations of BSA-4mg/ml, lipid-20 μ g/ml, and TF-22.5 μ g/ml. Pen/Strep and L-glutamine were also added. The medium was kept well gassed with 10% CO₂ during the setting up of cell cultures.

3) Microculture technique

The Terasaki plate microculture system described by O'Brien *et al* (1979) was used for all cell culture work.

i) Separation of cells from peripheral blood

Heparinised blood was mixed with IMDM (Flow) containing Pen/Strep and L-glutamine. A volume ratio of 1:2 was found to give the best cell yield for blood volumes between 1-5ml. The blood was layered on to 2ml Ficoll-Paque (Pharmacia) in 10ml conical centrifuge tubes (Sterilin) and spun at 1800rpm (650 x g) for 35mins. Mononuclear cells were harvested from the interface, washed twice and resuspended in IMDM to approximately 8×10^6 cells/ml. Cells were counted in a haemocytometer (Improved Neubauer, Hawksley Ltd.) after diluting the cell suspension 1:10 in 1% acetic acid containing a little crystal violet. Before culture, cell concentrations were adjusted to give 1,

2 and 4×10^6 cells/ml (and 8×10^6 if sufficient cells).

ii) Terasaki plate microculture system

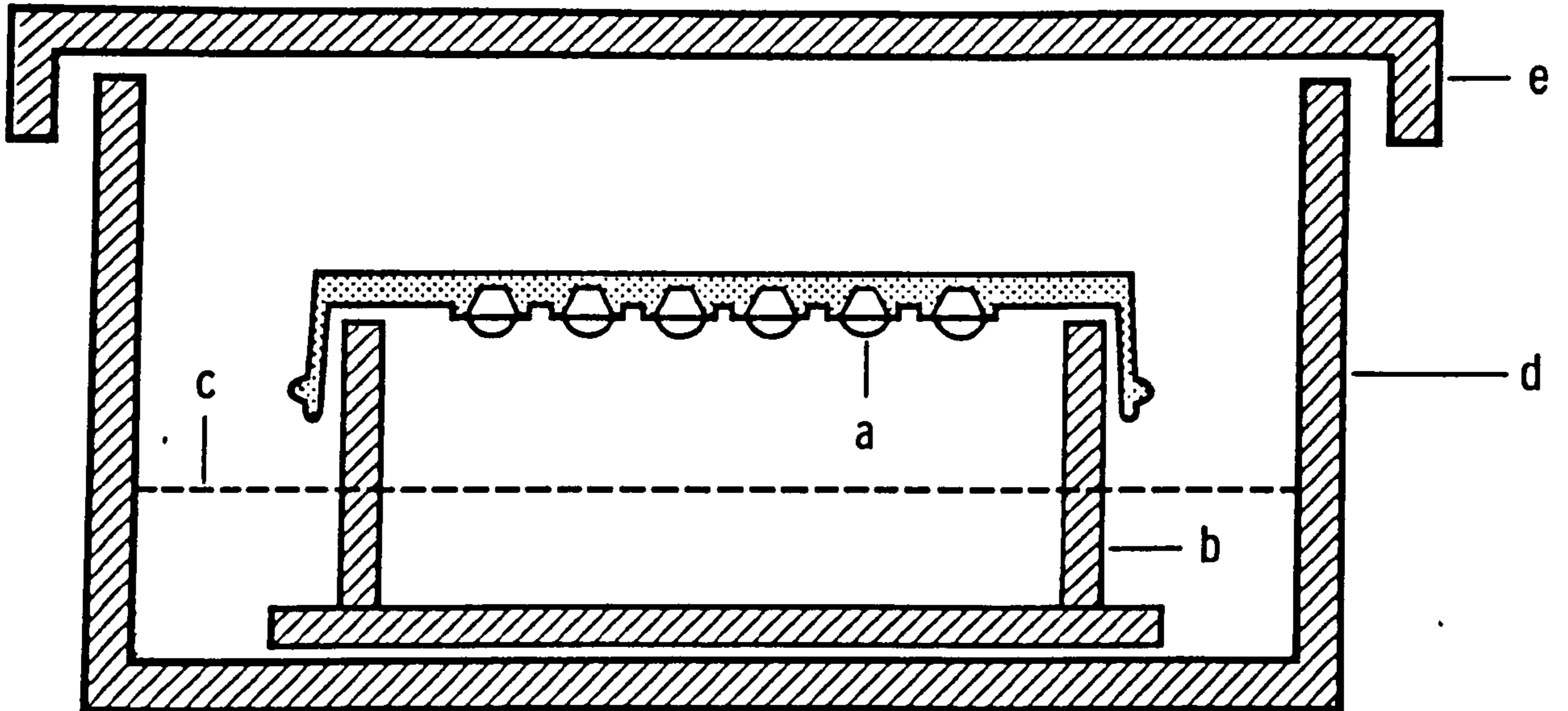
Suspensions were dispensed into Terasaki microculture plates (Falcon Plastics Ltd.) in $20\mu\text{l}$ volumes using a Hamilton syringe with a repeating dispensing unit. This volume gave a domed meniscus in the wells. All cultures were set up in duplicate. A control row with no stimulant was included for each plate. Separate plates were set up for each day of harvest (see below). For samples of low volume, priority was given as follows:- no stimulant, PHA, PWM, SAC, MLR, TT. For large volumes, extra harvest days and/or higher cell concentrations (8×10^6) were included. Stimulants were added in $1\mu\text{l}$ volumes to give final concentrations of PHA $1\mu\text{g/ml}$, PWM $1\mu\text{g/ml}$, SAC 1/2000, and TT 0.001Lfu/ml (see Chapter 4 for titrations). Plates were incubated inverted without lids (See Fig. 2 - 1) in equilibrated boxes containing 0.85% saline, at 37°C in a humid incubator with 5% CO_2 (Leec Ltd. Nottingham) for up to 6 days.

iii) Mixed lymphocyte cultures

Cultures were set up as described above except that cells were dispensed in $10\mu\text{l}$ volumes of double the final concentration. Mitomycin treated Cla-4 stimulator cells were thawed rapidly from liquid nitrogen by agitating the vial in a 37°C water bath. Cells were resuspended by dropwise addition of IMDM to give 4×10^6 cells/ml (2.5ml). These cells were added to the responder cells in $10\mu\text{l}$ volumes and two control wells were included containing stimulator cells only, to check the efficacy of the mitomycin treatment.

Figure 2 - 1

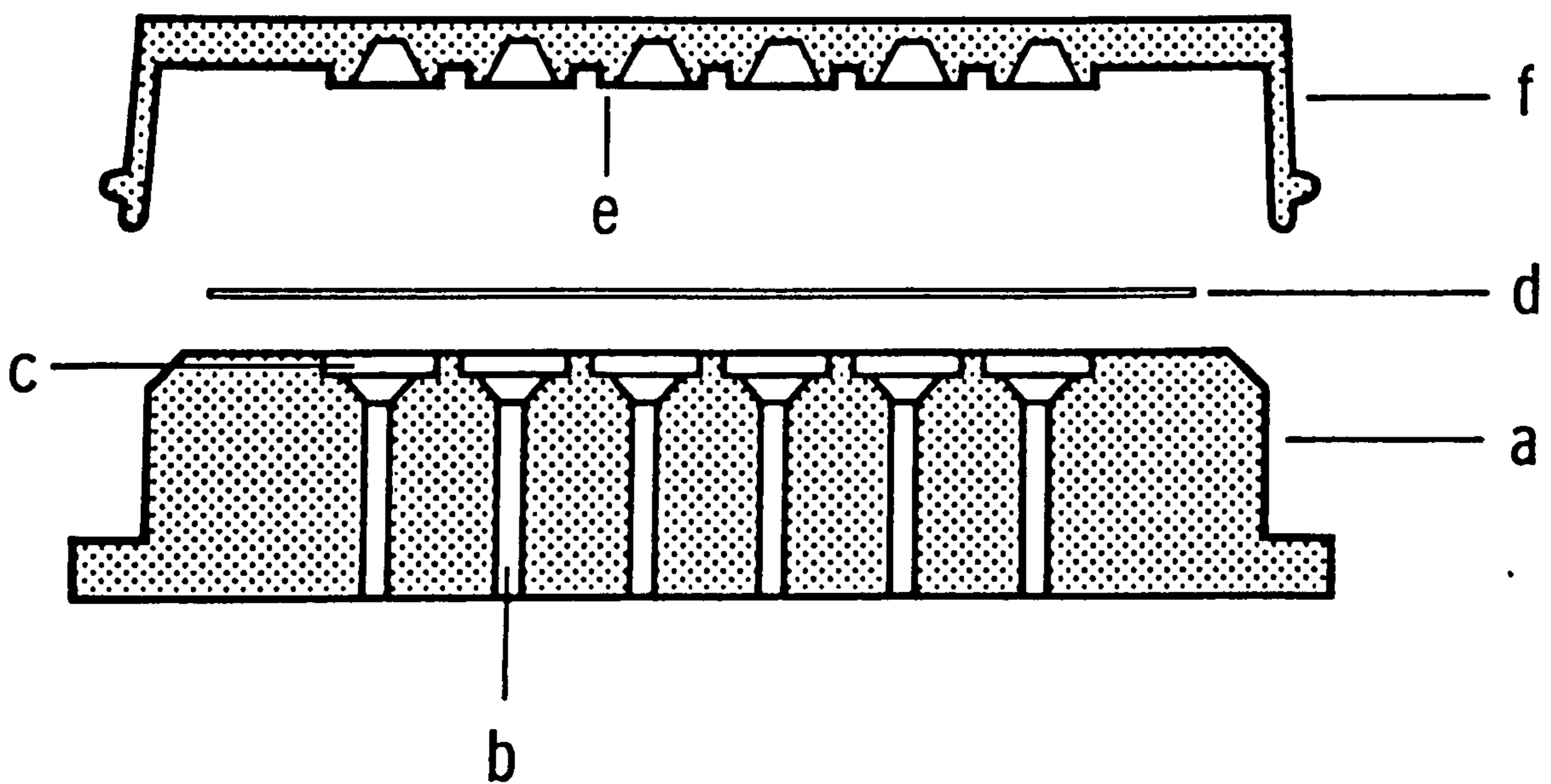
Terasaki plate culture system



- a) Meniscus of medium on which cells grow
- b) Support to hold culture plate above saline
- c) 0.85% saline
- d) Humidified box
- e) Loosely fitting lid to allow gassing of cultures

Figure 2 - 2

Terasaki plate harvester



- a) Polycarbonate harvester base
- b) Holes for removal of wash fluids
- c) Wells into which rims of Terasaki plate fit
- d) Glass-fibre filter
- e) Rims of Terasaki plate
- f) Template Terasaki plate for cutting 60 filter discs on to harvester

iv) Harvesting cultures for proliferation studies

Preliminary experiments (see Chapter 4) showed the maximum proliferative responses of infant lymphocytes to PHA occurred on about the third day of culture while PWM, SAC and MLR responses were maximal at 4-5 days. It was therefore decided to harvest all cultures on days 3 and 5, and on day 4 if cell numbers permitted. For pulsing, plates were suspended inverted in a bracket and 1 μ l of [³H-methyl] thymidine (Amersham Radiochemicals Ltd.) at 2Ci/mmol was added without disturbing the cell pellet on the meniscus. This gave a final concentration of 1 μ g/ml of thymidine (0.16 μ Ci/well). Plates were reincubated for 2hrs at 37°C. The cell pellets were harvested on to glass-fibre paper (Titertek, Flow Laboratories) previously cut on to a Terasaki plate harvester, shown in Fig 2 - 2 (Bioengineering Department, CRC) as described by O'Brien *et al* (1979). Suction was applied and the filter paper discs were washed with 10ml/plate each of 0.85% saline and 5% w/v trichloroacetic acid and dried with 10ml methanol. Discs were transferred to plastic scintillation vials (Hughes and Hughes Ltd., Romford, Essex), 0.5ml scintillant (NE 260, Nuclear Enterprises) was added, and the tubes capped and counted in a Wallac LKB scintillation counter.

SECTION D - IMMUNOGLOBULIN AND ANTIBODY ASSAYS

Assays were compared for estimating total immunoglobulins of G, M and A classes (Nephelometry and RIA), tetanus toxoid antibodies (ELISA and RIA), and *E.coli* antibodies (Indirect haemagglutination (IHA), ELISA and RIA). The relative merits of each assay will be discussed in detail in Chapter 6. RIA was used routinely for all assays because

of its high sensitivity, low sample volume requirement, and the convenience of carrying out all the assays on one sample by the same method. The RIA was therefore used to measure total IgG, IgM and IgA, class-specific tetanus toxoid and *E.coli* antibodies in all sera, secretions and cell culture supernatants. Total IgG, IgM and IgA estimations were also done routinely by nephelometry.

1) Standards for RIA

1) Preparation of affinity purified anti-*E.coli* standard

a) Coupling of *E.coli* 'O' LPS antigen to Sepharose

Epoxy-activated sepharose, 1g, (Sigma) was swollen on a sintered glass filter with 25ml of distilled water for 15mins, and washed with a further 75ml. To this, 10ml 0.02N NaOH was added, stirred and washed with a further 100ml distilled water. *E.coli* 'O' LPS antigen (10ml, adjusted to pH 12 with N NaOH) was mixed with the swollen gel in a siliconised universal, and rotated on an end-over-end rotator (Citenco Ltd., Herts.) at 37°C for 24hrs. The gel was washed with 100ml water and the remaining active groups blocked with 0.1M ethanolamine (pH 8.0) at 37°C for 4hrs on the rotator. The gel was returned to the filter, washed with distilled water, then alternately with acetate buffer (pH 4.0) and borate buffer (pH 8.0), four times, to remove non-covalently bound material. The coupled gel was then washed extensively with PBS containing 1% sodium azide, to remove weakly bound or adsorbed material, and stored at 4°C.

b) Purification of serum.

This gel was packed into a column (5ml syringe plugged with a disc of glass fibre paper), washed with 25ml PBS to remove the azide, and 10ml of a normal human serum with a high anti-*E.coli* titre added. Unbound

antibodies were removed by washing with 20ml PBS and anti-*E.coli* antibodies eluted with 0.2M glycine buffer (pH 2.3) and collected into an equal volume of 0.3M borate buffer (pH 8.0). The antiserum was dialysed overnight against 2 litres PBS, filter sterilised and stored at -70°C.

This nominally purified antibody was standardised by RIA against pure preparations of IgG, IgM and IgA (see below). It was found to contain 6000ng/ml total IgG, 8750ng/ml total IgM and 1100ng/ml total IgA. As no calibrated anti-*E.coli* standards were available, it was impossible to estimate the exact percentage of the total immunoglobulin that was specific for *E.coli*. An estimation was made by comparing the total Ig curves directly with those for class-specific *E.coli* antibodies. This assumes that the proportion of Ig molecules being bound by an optimal coating of anti-Ig will be the same as those being bound by an optimal coating of antigen, which is obviously not correct. However, this extrapolation of the curves gave an estimated 360ng/ml specific IgG, 400ng/ml IgM anti-*E.coli* and 150ng/ml IgA anti-*E.coli*, indicating that about 5-10% of the Ig was specific for *E.coli*. This estimation may not be unreasonable, as quantification of a similarly purified anti-TT serum against internationally standardised monoclonal antibodies indicated that 10-15% of the Ig was specific for TT (see below). For the purpose of these assays, the exact ng/ml quantity of specific antibody was not critical, as the main function was to provide a reliable and reproducible standard for the relative quantitation of all sera and secretions in this study.

ii) Affinity purified anti-tetanus toxoid antiserum

This antiserum was kindly supplied by Dr M.K.Brenner. Briefly, it was prepared by repeated passage of a high titre human antiserum down a column of tetanus toxoid bound to cyanogen bromide-activated sepharose. Specific antibodies were eluted, and filter sterilised. This preparation was standardised against a monoclonal anti-TT antibody (see below) for IgG, and a myeloma protein for IgM. About 15% of the IgG was found to be specific for tetanus toxoid, and about 10% of the IgM was specific for TT.

iii) Other standards

a) IgG k anti-TT monoclonal antibody

This antibody was the kind gift of Drs R.Tiebout and W.P.Ziejlemaker, Nederlands Red Cross Blood Transfusion Service, Amsterdam. It had been prepared from an EBV-transformed cell line, and standardised by RIA and ELISA against WHO standards.

b) IgM and IgA

The IgM myeloma was a gift of Dr Feinstein, Animal Research Institute, Bahraham, Cambs. Human colostrum IgA was kindly supplied by J.P.Pierce-Cretel and A.Decottignies, (Lille). It was prepared as described in an earlier publication (Stephens *et al*, 1981). Briefly, human milk was delipidated and decaseinated, then fractionated using a combination of a concentration gradient of $(\text{NH}_4)_2\text{SO}_4$ and a pH gradient as described by Montreuil *et al* (1960). Secretory IgA (sIgA) was isolated from fraction P4 obtained at 50% saturation in $(\text{NH}_4)_2\text{SO}_4$ at pH 7.0. It was purified by gel filtration on two coupled columns of Ultrogel ACA 44 (Industrie Biologique Francaise) as described by Pierce-Cretel *et al* (1980). This preparation was estimated to be

about 85% sIgA.

2) Preparation of Iodinated class-specific antisera for RIA

i) Coupling of immunoglobulin to CN-Br Sepharose

The colostrum sIgA was coupled to cyanogen bromide-activated sepharose (Pharmacia Fine Chemicals Ltd.) as follows. Cyanogen-bromide activated Sepharose 4B (0.5g) was mixed with 50ml 10^{-3} M HCl over a sintered glass filter, stirred and left 15mins to swell. Suction was applied and the gel was washed with a further 150ml 10^{-3} M HCl. IgA (4mg) was dissolved in 4ml freshly made coupling buffer (0.1M NaHCO₃ containing 0.5M NaCl). The IgA was then mixed with the swollen gel in a siliconised universal container and rotated end over end at RT for 2hrs. The coupled gel was returned to the filter and washed with 50ml coupling buffer to remove unbound material. The gel was returned to the siliconised universal container and remaining active groups blocked by reacting with 4ml 1M ethanolamine (adjusted to pH 8.0 with concentrated acetic acid) for 2hrs at RT on the rotator. Non-covalently bound protein was removed by three washing cycles, each consisting of 5-10ml 0.1M acetate buffer containing 1M NaCl, pH 4.0, and 5-10ml 0.1M borate buffer containing 1M NaCl, pH 8.0. The gel was then washed thoroughly with PBS+1% azide to remove weakly bound or adsorbed immunoglobulin. The gel was stored at 4°C in PBS/azide. Cn-Br sepharose coupled to IgG, and to IgM myeloma proteins were supplied by Dr M.K.Brenner.

ii) Iodination of coupled anti-immunoglobulins

The method described by Brenner (1981) was used. Columns were prepared by removing the end of a 400µl microfuge tube, plugging with

glass fibre and packing with 100 μ l swollen Sephadex G25. On to this was layered 20 μ l Sepharose 4B-coupled Ig (G, M or A). The columns were washed thoroughly to remove the azide. Rabbit anti-human IgA (α -chains and secretory component), -IgG (γ -chains) or -IgM (μ -chains) (Dakopatts Immunoglobulins, Denmark) were spun (0.5ml) at 15000g for 5mins and added to the columns. Unbound antiserum was removed by washing with 4ml PBS. Antisera were iodinated using the chloramine-T method (Hunter and Greenwood, 1962). To the top of the column was added 10 μ l (1mCi) of 125 I labelled sodium iodide in carrier free medium quickly followed by 15 μ l freshly made chloramine-T (1.33mg/ml in 0.05M phosphate buffer pH 7.5). The top third of the column was mixed using a hypodermic needle and after 30 seconds the reaction was terminated by adding 25 μ l sodium metabisulphite (4mg/ml in 0.05M phosphate buffer pH 7.5) and remixing the top third of the column. Unbound 125 I was removed by thorough washing with PBS. Radiolabelled antibody was eluted with 6 drops glycine buffer, pH 2.3. The first drop was discarded, and the next 5 drops were collected into serum tubes containing 120 μ l 0.3M borate buffer, pH 6.8 containing 1% BSA. The two most radioactive fractions were pooled (usually 2 and 3), mixed with an equal volume of glycerol and stored at -20°C.

3) Solid-phase Radioimmunoassay method (RIA)

i) Basic technique

The technique of Brenner and Munro (1981) was used. For measurement of specific antibodies, flexible microtitre trays (Linbro, Scotland) were coated for 1hr at RT with 20 μ l/well of TT (1 Lfu/ml) or the *E.coli* 'O' LPS antigen diluted 1/10 in PBS. For measurement of total immunoglobulins 20 μ l of rabbit anti-IgG (1/500), -IgM (1/750) or -IgA

(1/500) were substituted. The results of preliminary titrations to determine the optimal concentration of tetanus toxoid and *E.coli* antigen are shown in Figures 2 - 3 and 2 - 4. A titre was supplied with the anti-immunoglobulins and the appropriateness of this dilution for coating the plates was checked, as shown for anti-IgG in Figure 2 - 5. Coated trays were washed 6 times with PBS and remaining sites were blocked with PBS containing 0.2% gelatin (Oxoid), 0.2% BSA and 0.1% sodium azide for 2-12hrs at RT (see below). After further washing, 20 μ l of serial dilutions (see relevant Chapter for dilutions used) of control sera, test sera, secretions or cell culture supernatants in blocking buffer were added. Plates were incubated overnight at RT, washed 6 times and to each well was added 20 μ l of ¹²⁵I labelled rabbit anti-human IgG, -IgM, or -IgA diluted in blocking buffer to give approximately 100c.p.s. After 2hrs at RT trays were washed, dried, cut up and counted in a Gamma counter (NEC 1600, Nuclear Enterprises, Edinburgh) for 60 seconds.

ii) Standardisation of RIA

Duplicate rows of the standard sera described above were included in each test. Two control normal adult sera were also included in each assay to check the reproducibility of the technique. These sera had also been standardised for total immunoglobulins by nephelometry. The reproducibility was calculated from log-transformed data as follows:-

$$\text{Reproducibility} = \frac{97.5\% \text{ C.L.} - 2.5\% \text{ C.L.}}{\text{Geometric mean}} \times 100$$

where C.L. refers to the confidence limits of the sample. The results are shown in Table 2 - 1.

Figure 2 - 3

Tetanus toxoid antigen titration for RIA

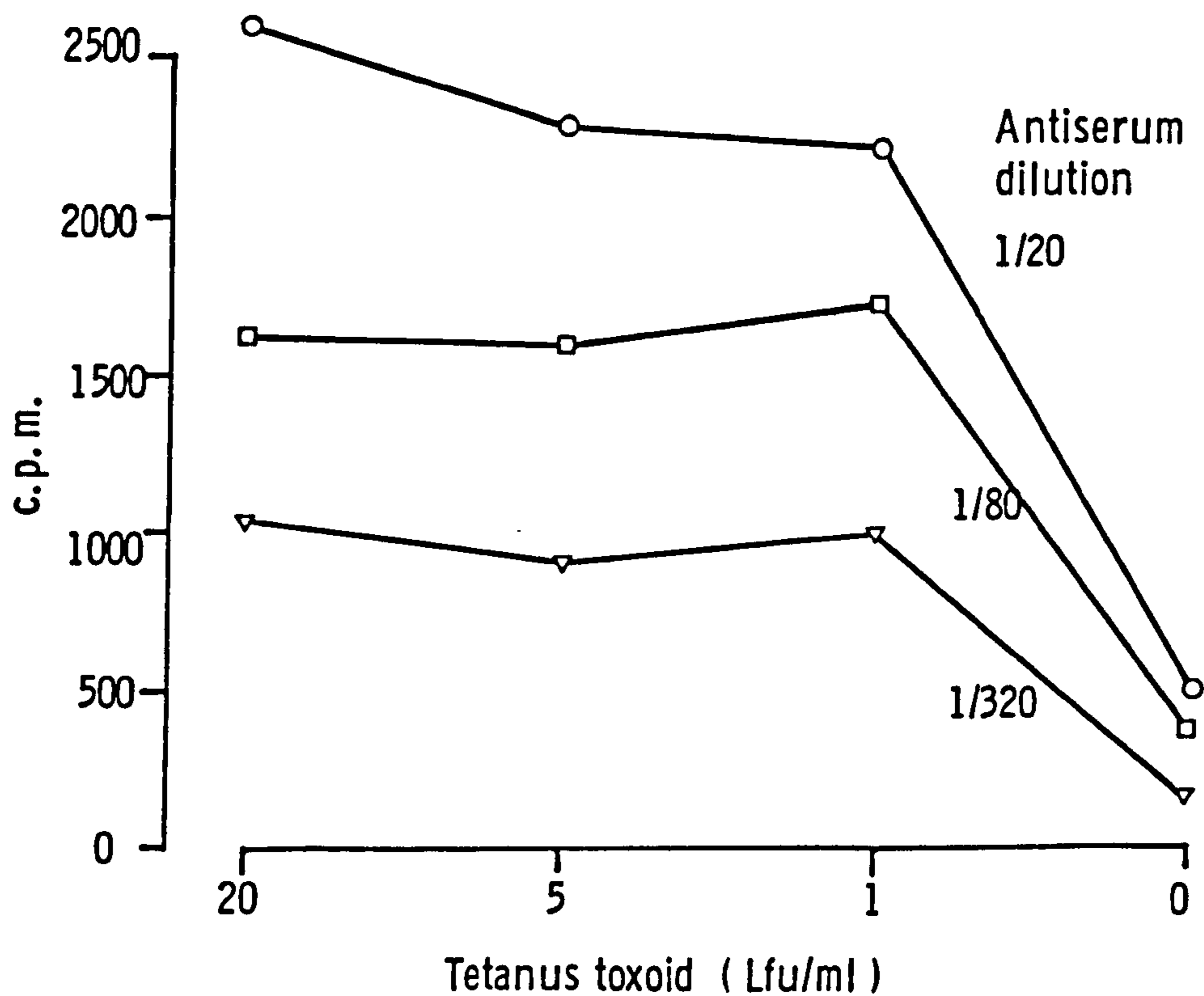


Figure 2 - 4

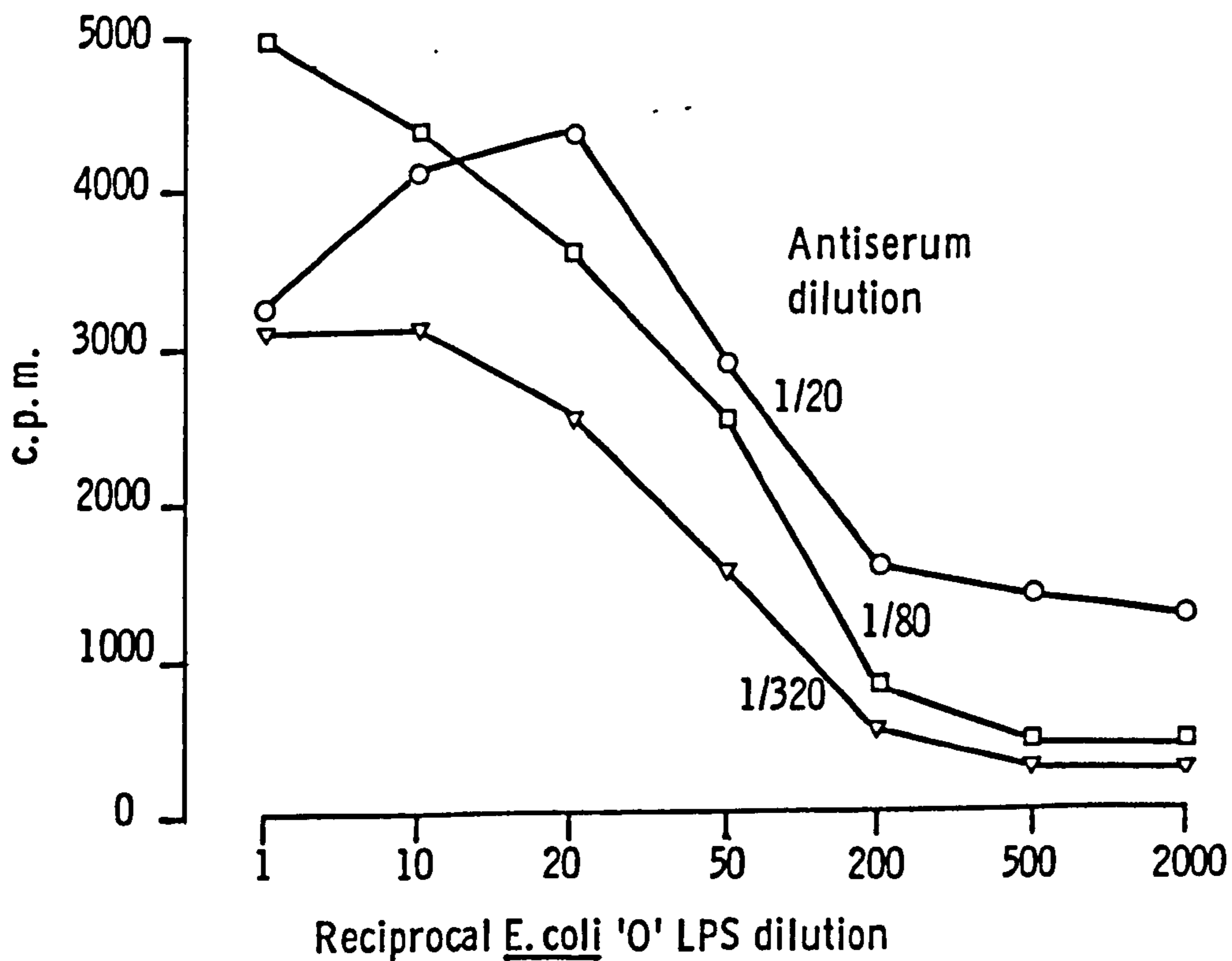
E. coli 'O' LPS antigen titration for RIA

Figure 2 - 5

Titration of anti-IgG serum for RIA

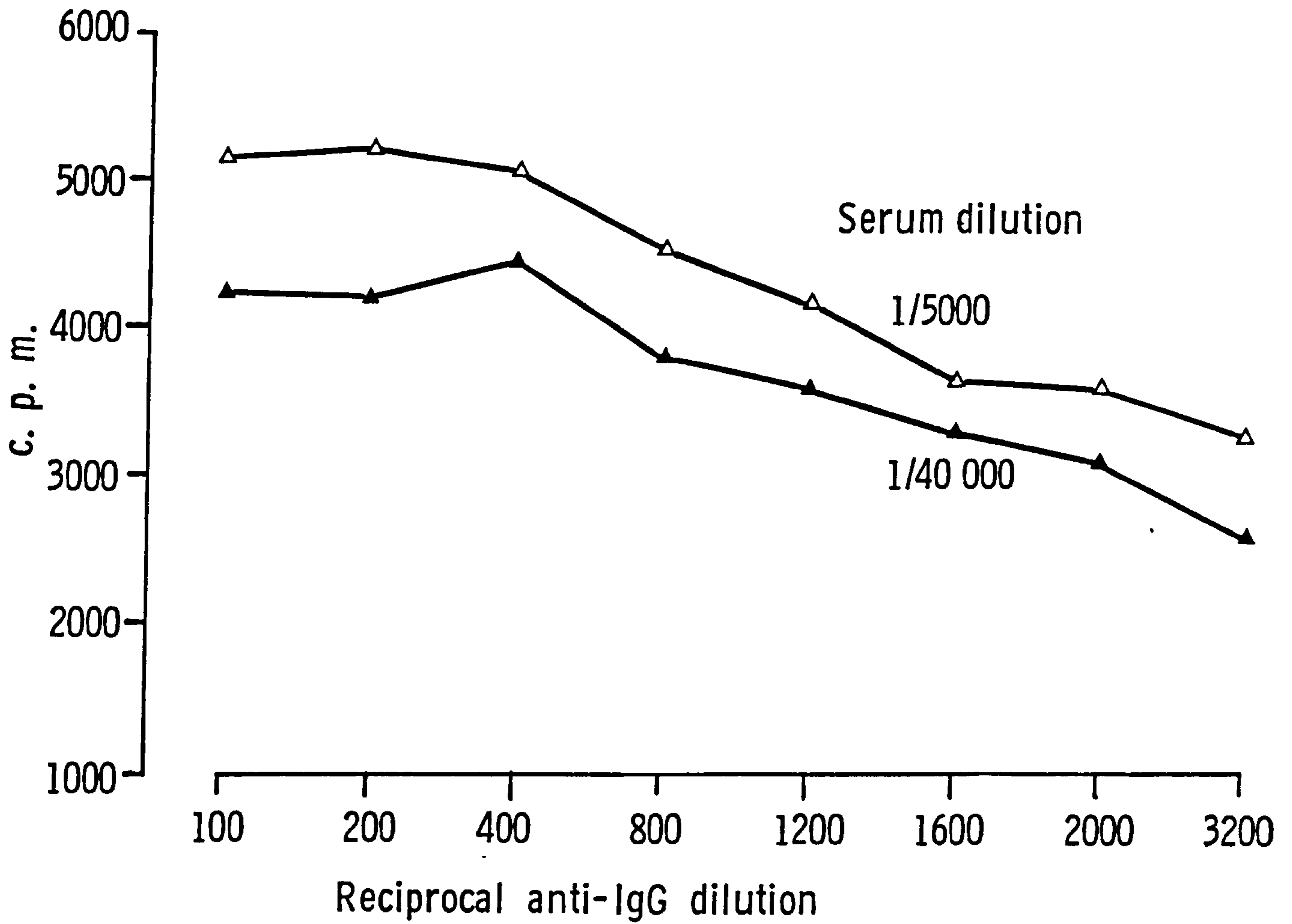


TABLE 2 - 1
 PERCENTAGE REPRODUCIBILITY OF RIA

	IMMUNOGLOBULIN		
	G	M	A
TOTAL Ig	66	44	38
ANTI-TT	26	32	60
ANTI-E.COLI	22	27	34

The poor reproducibility for total IgG levels in serum is discussed further in Chapter 6.

a) Specificity of anti-immunoglobulins

The specificity of the anti-immunoglobulins was checked against the monoclonal IgG, IgM myeloma and purified colostrum IgA (Figure 2 - 6). The IgA preparation was only 85% pure, and some of the 15% impurities were undoubtedly IgG. This is reflected in Figure 2 - 6. The specificity of the system for each immunoglobulin is summarised in Table 2 - 2, and this indicates between 700 to 4000-fold greater specificity for the relevant immunoglobulin.

b) Non-specific binding controls

Control rows with no antigen were included for each sample and these values, representing non-specific binding, were subtracted from the test values. For a few infant sera, a high non-specific binding of IgM occurred. In order to overcome this problem, experiments were conducted with different blocking buffers.

Figure 2 - 6 . Specificity of anti-Ig sera for monoclonal IgG, IgM myeloma and colostral IgA preparations.

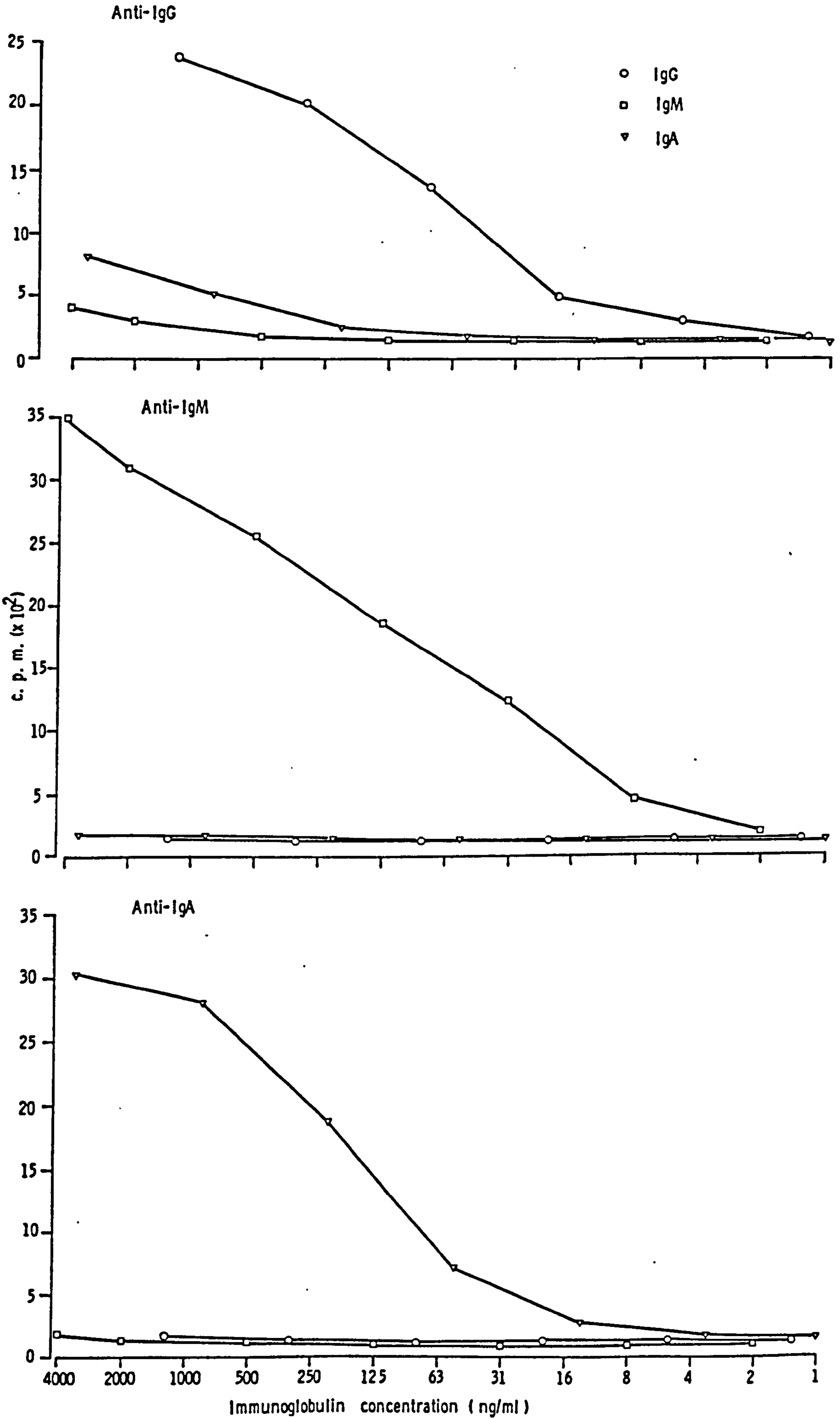


TABLE 2 - 2

SPECIFICITY OF ANTI-Ig SERA FOR DETECTING RELEVANT Ig ISOTYPE

Ig	ANTISERUM		
	ANTI-IgG	ANTI-IgM	ANTI-IgA
IgG* (monoclonal)	6000**(100)	<20 (<0.3)	<3 (<0.05)
IgM (myeloma)	8.6 (0.13)	6000 (100)	1.5 (0.025)
IgA (colostral)	32 (0.5)	<5 (<0.1)	6000 (100)

* Ig preparations were diluted to contain 6000ng/ml of the designated isotype

** Figures are expressed as ng/ml with % specificity in parenthesis

NB sIgA preparation was only estimated to be 85% pure

There was a possibility that anti-BSA antibodies were present in the sera of infants being fed cow milk proteins. This protein was removed from the blocking buffer and either an extra 0.3% gelatin, or 0.2% globulin-free human serum albumin (Sigma) substituted. Another experiment was set up with a blocking buffer containing 5% normal sheep serum in PBS. None of these modifications made any difference to the non-specific binding of these sera, and results were therefore calculated after the subtraction of the high background values.

c) Negative controls

Controls with antigen but no sample were included to determine the non-specific binding of the iodinated anti-immunoglobulins.

CHAPTER 3

FAMILIES AND INFANTS

In order to compare the development of immune function in two groups of infants being fed either breast milk or cow milk based formula, it was important that the two groups were matched for all other aspects which might influence immunological development. Previous studies on the immunity of breast- and bottle-fed infants which investigated infection rates in the two groups showed that factors associated with an increased risk of infection were those related to the family situation; poor parental education, employment status, lower maternal age, higher number of siblings, overcrowding and poor hygiene in the home, as well as low infant birth weight and poor infant care (Robinson, 1951; Cunningham, 1979; Pullan *et al.*, 1980). In an attempt to match the two groups as closely as possible for these factors which might therefore be considered to affect immune function, details of the family situation were recorded for all infants, together with information about intercurrent infections.

SECTION A - ANALYSIS OF QUESTIONNAIRES

1) Family History

Information about family history, maternal age, pregnancy and birth details are shown in Table 3 - 1. A detailed family medical history was taken for each infant. There were no families with any history of immunodeficiency or problems with severe infections. Note was also taken of any history of allergy in first or second degree relatives of the infant. Allergies reported in Table 3 - 1 include pollen (hayfever), foods and drugs. Eczema and asthma were also

included as allergies although their allergic basis was often unconfirmed. In the group of infants being breast-fed, there were 5 cases of allergy in 1st degree relatives and 3 in 2nd degree relatives. In the bottle-fed group there were 4 cases in 1st degree relatives, with a possible 5th case (query eczema in an older sibling) and one case in a 2nd degree relative.

2) Maternal Age

Maternal age ranged from 20-37 years, with the mean maternal age (\pm SD) at delivery being 31.3 (4.35) for the breast-feeding group and 27.3 (4.3) for the bottle-feeding group. This 4 year difference in ages was significant ($P=0.019$; pooled t-test), and was associated with a higher number of previous children (see Section 5, Table 3 - 4) in the breast-feeding group.

3) Social Class and Socioeconomic Groups

Paternal occupations were used to assess social class and socioeconomic groupings according to the Government Classification of Occupations (1980) and these are shown in Table 3 - 1. The distribution according to feeding groups is shown in Table 3 - 2. Most breast-feeding families were Social Class II (13/15) and most bottle-feeding families were Social Class III (9/15). This difference in Social Class distribution was statistically significant (chi-squared = 14.17, $P<0.01$). There was also a significant difference ($P < 0.05$) in the Socioeconomic groupings of the families, with a predominance of breast-feeding families (8/15) in Group 5 and bottle-feeding families (6/15) in Group 9.

TABLE 3 - 1

FAMILY DETAILS

INFANT NUMBER	FAMILY ALLERGY	MATERNAL AGE(YRS)	PATERNAL OCCUPATION	SOCIAL CLASS	SOCIOECONOMIC GROUP
BREAST-FED					
02	A1*	22	COMPUTER PROGRAMMER	II	5
03	A1	35	MARKETING MANAGER	II	2
05	-	25	ACCOUNTANT	II	5
06	-	34	TEACHER	II	5
07	-	29	TRANSPORT MANAGER	II	2
08	A1	33	VIDEOTAPE EDITOR	II	5
09	-	37	LABOURER	V	11
10	-	34	CIVIL SERVANT	II	5
11	A2	33	INSURANCE BROKER	II	5
12	A2	34	ANTIQUA DEALER	II	2
14	A1	29	LIBRARIAN	II	5
17	-	34	SURVEYOR	II	5
18	A2	29	TV MANAGEMENT	II	1
27	-	35	MECHANICAL ENGINEER	III	10
31	A1	26	RETAILER	II	2
MEAN(SD)		31.3(4.35)			
BOITLE-FED					
01	-	20	SERVICE ENGINEER	III	9
04	A1	34	MEDICAL GAS SUPPLIER	III	9
13	-	30	MOTORMAN	III	9
15	-	30	FIREMAN	III	6
16	-	29	LECTURER	II	5
19	-	28	SERVICE ENGINEER	III	9
20	-	31	POSTAL WORKER	IV	10
22	A1	22	ROOFING CONTRACTOR	IV	2
23	-	23	FOREMAN LOND. TRANSP.	III	8
24	A2	34	MILKMAN	III	9
25	?A1	24	INSOLVANCY OFFICER	III	6
26	-	28	MANAGEMENT ACCOUNTANT	II	5
28	-	23	PLUMBER	III	9
29	A1	29	BROADCASTING ENGINEER	II	4
30	A1	25	SURVEYOR	II	2
MEAN(SD)		27.3(4.3)			

* A1 = Allergy in 1st degree relatives of infants
 A2 = Allergy in 2nd degree relatives of children

TABLE 3 - 2

RELATIONSHIP BETWEEN FEEDING GROUP AND SOCIAL STATUS

	SOCIAL CLASS				
	I	II	III	IV	V
BREAST-	0	13	1	0	1
BOTTLE-	0	4	9	2	0

CHISQUARED = 14.17 DF = 3 P < 0.01

	SOCIOECONOMIC GROUPS								
	1	2	4	5	6	8	9	10	11
BREAST-	1	4	0	8	0	0	0	1	1
BOTTLE-	0	1	1	3	2	1	6	1	0

CHISQUARED = 16.08 DF = 8 P < 0.05

4) Pregnancies and Births

All pregnancies progressed normally without any significant medical problems, except for the mother of infant 02 who required Ventolin therapy following an asthmatic attack during the 4th month of pregnancy. Details of births are shown in Table 3 - 3. The infants were born between August 1981 and July 1982. All births occurred between the 38th and 41st weeks of pregnancy. The mean gestation times were 40.4 and 39.8 weeks for the breast- and bottle-feeding groups respectively. There were no major birth problems; 5 deliveries required the use of forceps (3Br,2Bo), 3 were induced (2Br,1Bo), and 2 infants were delivered by caesarian section (1Br,1Bo). Birth weights ranged from 2.5 to 4.3kg with the means for the breast- and bottle-fed groups being 3.37 and 3.40kg respectively. There were 17 female (9Br,8Bo) and 13 male (6Br,7Bo) infants.

5) Siblings

The number of older siblings per family, their ages at the time of the birth of the infants being studied, and their feeding group are shown in Table 3 - 4. The distribution of siblings according to feeding group and family size is summarised in Table 3 - 5.

TABLE 3 - 3
BIRTH DETAILS

BREAST-FED GROUP					BOTTLE-FED GROUP				
INF. No.	GESTATION TIME(WKS)	BIRTH *	BIRTH WEIGHT (KG)	SEX	INF. No.	GESTATION TIME(WKS)	BIRTH	BIRTH WEIGHT	SEX
02	41	I,F	3.46	F	01	40	N	3.25	M
03	40	N	3.91	F	04	40	F	4.14	M
05	40	N	3.18	F	13	41	I	3.62	M
06	40	N	3.1	M	15	40	N	4.32	F
07	40	F	3.91	M	16	39	N	3.06	M
08	40	N	3.63	M	19	38	N	3.21	F
09	40	N	3.55	M	20	41	N	3.2	M
10	41	N	4.0	F	22	40	F	2.77	F
11	40	CS	3.2	F	23	40	N	3.38	M
12	41	N	2.94	M	24	39	CS	3.62	F
14	41	N	3.18	F	25	41	N	3.63	M
17	42	I	3.54	F	26	38	N	3.29	F
18	40	N	3.2	M	28	41	N	3.92	F
27	39.5	F	3.23	F	29	40	N	2.95	F
31	40	N	2.5	F	30	39.5	N	2.68	F
MEAN	40.4		3.37			39.8		3.40	

*I = Induced
 F = Forceps delivery
 N = Normal vaginal delivery
 CS = Caesarian section

TABLE 3 - 4

SIBLING AND FEEDING DETAILS

INF. No.	NO. SIBS	SIBLING AGES	SIBLING FOOD	INITIAL FOOD	FORMULA ADDED	SOLIDS ADDED	PAST. COW MILK INTRODUCED	BREAST MILK STOPPED
02	1	1y 6m	Br 4†	Br	1.5	5	6	2
03	1	1y 4m	Br 8	Br	-	3	7.5	7.5
05	2	2y 11m	Bo	Br	-	5	8	8
		1y 10m	Br 7					
06	0	-	-	Br	-	3	3	>9
07	1	1y 5m	Br 8	Br	-	3	?	7.5
08	2	4y 10m	Br 8	Br	-	3*	>9	>9
		2y 7m	Br 11					
09	3	15y 3m	Br 1	Br	1	3	3	1.5
		14y 3m	Bo					
		1y 2m	Br 3					
10		2y 3m	Br 8	Br	4	4	>9	>9
11	1	1y 9m	Br 6	Br	3	3	>9	>9
12	2	4y 4m	Br 8	Br	-	4	?	7
		2y 4m	Br 7					
14	1	1y 11m	Br 9	Br	-	4	6	>9
17	0	-	-	Br	-	4	8.5	8.5
18	1	3y 2m	Br 10	Br	-	4	8.5	8.5
27	1	2y 11m	Br ?	Br	-	4	6.5	>9
31	1	2y 8m	Br 2	Br	1	5	5	2
MEAN	1.2	3y 3m				3.8		7.1
01	0	-	-	SMA	-	2	8	
04	1	6y 2m	Bo	SMA	-	4	6	
13	1	4y 4m	Br 0.2	SMA	-	2.5	7	
15	1	4y 7m	Br 1.5	SMA	-	4	6	
16	1	2y 8m	Bo	SMA	0.2**	4	9	
19	2	4y 1m	Br 7.5	SMA	-	?	5	
		2y 9m	Br 6.5					
20	0	-	-	SMA	-	3.5	7	
22	0	-	-	SMA	-	4	>9	
23	0	-	-	SMA	-	2	8	
24	1	2y 7m	Br 0.2	SMA	2.5	3	5.5	
25	2	5y 10m	Bo	SMA	0.2	3	6	
		3y 5m	Bo					
26	0	-	-	SMA	-	2	7	
28	1	3y 8m	Bo	SMA	-	2	6	
29	0	-	-	SMA	1	2	5	
30	1	3y 5m	Bo	SMA	-	4	5	
MEAN	0.7	3y 11m				3.06	7.2	

Br = Breast milk

Bo = Cow milk formula

SMA = SMA Gold Cap, cow milk based formula

† Figures for times are in months

* Infant was on an allergen-free diet, see text for details

** Age (months) formula changed from SMA to Ostermilk Complete Formula

TABLE 3 - 5

RELATIONSHIP BETWEEN FEEDING GROUP AND NUMBER OF SIBLINGS

	NUMBER OF SIBLINGS				
	0	1	2	3	ALL
BREAST-FED	2	9	3	1	15
BOTTLE-FED	6	7	2	0	15
ALL	8	16	5	1	30

CHI-SQUARED = 3.45 DF = 3 P = 0.3

Fewer breast-fed infants had no siblings (2 Br, 6 Bo) and the mean number of siblings per family in the remaining families was higher (1.4 Br, 1.1 Bo). This resulted in an overall mean number of siblings per family of 1.2 in the breast-fed group and 0.7 in the bottle-fed group. This difference was not significant (Chi-squared = 3.45, P=0.30). At the time of birth of the infants under study, sibling ages were younger in the breast-fed group. The mean age for the breast-fed group was 3yr 3mth (2yr 5mth excluding the 14 and 15 year old children in family 09) compared with 3yr 11mth in the bottle-fed group. In the breast-feeding group, the length of time the mother had breast-fed a previous infant was a good indication of the likelihood of prolonged breast-feeding in the infants under study.

6) Feeding regimes

Details of infant feeding are shown in Table 3 - 4.

a) Breast-fed infants

All infants in this group were exclusively breast-fed at the time of the first sample (6-7 days). Three infants (02,09,31) were weaned from the breast early (1.5-2 months) and cow milk formulae were introduced as early as 1 month. These infants were analysed separately where appropriate. The other 12 infants were breast-fed until at least 7 months, with 6 infants still receiving breast milk at the end of the 9 month study period. Solids were included from 3 months (mean 3.8m) and this usually involved the introduction of cow milk proteins as a diluent for cereals.

b) Bottle-fed infants

All infants were fed at NPH with SMA Gold Cap cow milk based formula from birth. Four infants (16,24,25,29) were later changed to Ostermilk Complete Formula and one infant (24) also received Cow and Gate formula (see Appendix for Formulae details). Solids were included in the diet from 2 months (mean 3.1m) which was slightly earlier than the breast-fed group (mean 3.8m).

7) Intercurrent Infections

Details of intercurrent infections and their treatment are shown in Table 3 - 6 . Infections were recorded by the mothers, and where they were insufficiently serious to require medical attention no further verification was made. No attempts were made to isolate or identify infectious agents so many of the recorded episodes may not have had an infectious aetiology. This is particularly likely for the

TABLE 3 - 6 continued

BREAST-FED contd.

14	3	3	-	0	0	0		
		4	AMP					
		9	"					
17	2	3	-	1	3*	-	1	8 VIRAL ERYTHRO
		5.5	-					0
18	6	0.5	EPHEDRINE	0			1	7 PERTUSSIS ERYTHRO
		1	-					4
		1.5	EPHEDRINE					V.R. 8
		3	"					
		4	"					
		6	AMP					
27	4	1	EPHEDRINE	0			0	0
		3	-					
		7	-					
		9	PEN					
31	5	1.5	-	1	10	-	2	1.5 VOMITING OBS.NPH
		2	-				5	ROSEOLA -
		3	-					0
		5	ERYTHRO					
		8.5	-					
TOTAL 49				6			9	2
MEAN 3.3								

BOTTLE-FED

01	1	7	-	1	4.5	-	1	0-1.5 ST. EYE CHLOR.CR	7
04	3	1	AMOXYL	0			0		0
		5	-						
		9	AMOXYL						
13	3	1	-	0			0		0
		3	-						
		5	-						
15	0			0			0		3
16	2	1	PEN	1	3	-	0		0
		8	-						

TABLE 3 - 6 continued

BOTTLE-FED contd.

19	2	5.5 - 7	AMOXYL	0		2	3 5	?C. POX ?RUBELLA	-	0
20	2	2 - 8 -		0		0				0
22	3	0.7 8 - 9 -	ERYTHRO	1	3* PEN	2	0.7 3	ST. EYE OTITIS	GENT.DR PEN	1
23	0			0		0				0
24	3	4 6.5 8.5	AMP " ERYTHRO	0		1	1	ORAL CAND	NYSTAT	0
25	5	0.7 4.5 - 6 - 7.5 - 9 -	LINCTUS	0		0				0
26	0			1	5 -	0				0
28	4	6-10 -		0		0				0
29	3	2.5 - 3.5 - 9	ACTIFED	3	1 FORM.CH. 5.5 - 9 -	1	3	COXSACKIE	- NPH	0
30	3	2.5 - 6 9	AMP	1	10 -	2	3 5	VACC.R. "	- -	0
TOTAL		34		7		8				3

MEAN 2.3

|| Antibiotic, type not known

* Diarrhoea concurrent with URTI

% Vaccine reaction

** Concurrent with viral meningitis in father

! URTI and Otitis media concurrently

† Contact only

episodes of diarrhoea.

a) Upper Respiratory Tract Infections (URTI)

The most common infection recorded was of the upper respiratory tract (URTI) and several children suffered recurrent infections. The distribution of the number of URTI episodes per infant according to feeding group are shown in Table 3 - 7.

TABLE 3 - 7
RELATIONSHIP BETWEEN FEEDING GROUP AND NUMBER OF
UPPER RESPIRATORY TRACT INFECTIONS

	NUMBER OF INFECTIONS							ALL
	0	1	2	3	4	5	6	
BREAST-FED	1	1	4	1	4	2	2	15
BOTTLE-FED	3	1	3	6	1	1	0	15
ALL	4	2	7	7	5	3	2	30

CHI-SQUARED = 8.85 DF = 6 P = 0.2

Eight breast-fed and 2 bottle-fed infants suffered 4 or more episodes of URTI during the study period. The mean number of URTI for breast-fed infants was 3.3 episodes/child and for the bottle-fed infants 2.3 per child. This higher number in breast-fed infants was not significant (chi-squared = 8.85, P=0.22) but was correlated with greater numbers of siblings in this group (chi-squared = 30.67, P=0.031). For infants with no siblings, there were 5/8 infections and for those with siblings there were 21/22. Examination of the age of infants at the onset of their first URTI gave a mean age of 1.8 months

for the breast-fed group and 2.8 months for the bottle-fed group. The breast-fed infants therefore not only had more infections, but contracted them earlier. There were a total of 19 recorded URTI episodes which occurred in breast-fed infants before the introduction of any dietary supplements, i.e. while infants were being exclusively breast-fed.

b) Gastrointestinal Tract Infections

Episodes of diarrhoea were infrequent; there were a total of 6 episodes in the breast-fed group and 7 in the bottle-fed group. Four of these were associated with a change of diet (introduction of solids or change of milk) and were thought not to be caused by infectious agents. Six of the episodes occurred at the same time as an URTI or otitis media, and 2 (infants 30 and 31) were diagnosed as having viral gastroenteritis contracted from a common source.

c) Other Infections

Other infections (9 Br, 7 Bo) are listed in Table 3 - 6. All of these infections were considered by the mother to be sufficiently serious to require medical attention, and the infants were seen either by a general physician or an NPH paediatrician. Two breast-fed infants (10, 12) received prophylactic treatment following contact, one for whooping cough and the other for measles.

8) Allergies

Three bottle-fed infants had mild eczema (Table 3 - 6), associated in two of these cases with a history of eczema in one of the parents. One breast-fed infant (08) had moderately severe eczema. This family had a history of allergy in an older sibling, and the

infant studied was also recruited to a study on allergy at the Central Middlesex Hospital. He was found to be allergic to cow milk, eggs, gluten and citrus fruits. Both he and his mother were placed on an exclusion diet from 7 months of age, which resulted in a considerable improvement in his symptoms.

9) Vaccination Schedules

The recommended vaccination protocol was 3, 5 and 9 months, but because the vaccinations were administered by general physicians or various 'Well-Baby' Clinics, and because of a general policy not to administer vaccinations while the infants were ill, there was considerable variation in the timing of doses and also in the number of doses received by 9 months (Table 3 - 8). Most infants received triple vaccine (Diphtheria, Tetanus and Pertussis) containing 60 I.U. tetanus toxoid/dose. Four infants (02, 11 Br; 25, 28 Bo) received DT vaccine (Diphtheria and Tetanus with no Pertussis), infant 10 received only half-dose pertussis with his first dose, and infant 20 had the pertussis component in his first but not second dose. Infant 30 reacted to both doses of triple vaccine with prolonged screaming and fever and it was recommended that the pertussis component be excluded from the third dose. One infant (12) did not receive any vaccinations during the study period. The average times for the first and second doses of vaccine were 4.15m and 6.75m for the breast-fed infants and 3.75m and 6.10m for the bottle-fed infants. Because more of the bottle-fed infants (eight) had received their second dose before 6m than breast-fed infants (three), direct comparison of specific anti-TT responses between the groups could not be made. The infants were therefore allocated to the following vaccine groups according to their

TABLE 3 - 8

VACCINATION SCHEDULES

BREAST-FED INFANTS				BOTTLE-FED INFANTS			
INFANT	VACCINE	AGE AT DOSE	VACCINE GROUP	INFANT	VACCINE	AGE AT DOSE	VACCINE GROUP
		1 2 3				1 2 3	
02	DT +Po	3.25 6.5	II	01	DTP +Po	3.0 5.5	III
03	DTP +Po	3.1 5	III	04	DTP +Po	4 7	II
05	DTP Po	4.5 6 7 1.5 7	V(II)	13	BCG DTP +Po	0.75 6.5	I
06	DTP +Po	4 6.01	II	15	DTP +Po	3.5 5.75	III
07	DTP +Po	5 8	II	16	DTP +Po	5	I
08	DTP +Po	3.75 8.25	II	19	DTP +Po	4.25 6.5	II
09	DTP +Po	4.5 7.5	II	20	DTP +Po	3.5 6.0*	II
10	DTP +Po	3.51 6.75	II	22	DTP +Po	4	I
11	BCG	0.5			BCG	6.5	
12	DT +Po	6.1 8	IV	23	DTP +Po	3.25 5	III
14	-		O	24	DTP +Po	3.0 5	III
17	DTP +Po	3.5 6.5	II	25	DT +Po	3.5 8.5	II
18	DTP +Po	6.1 8.5	IV	26	DTP +Po	3.0 5.5	III
27	DTP +Po	3.5 5.75	I	28	DT +Po	4 9.5	II
31	DTP	3.5 5 6 9	III	29	DTP +Po	3.0 4.75	III
	Po	7 8	V(III)	30**	DTP +Po	3.0 4.25	III
MEAN		4.15 6.75				3.75 6.1	

* DT +Po only

! Half dose pertussis only

** Infant had bad IVaccine reaction to both doses and results were therefore excluded from analyses

DT = Diphtheria and Tetanus; DTP = Diphtheria, Tetanus and Pertussis
Po = Oral Polio; BCG = Tuberculosis Vaccine

vaccination schedule and each group analysed separately for the response to tetanus toxoid vaccine (see Chapter 6).

Vaccine group	Vaccine given
I	1 dose only
II	1 dose 3-6 months, 2nd dose 6-9 months
III	2 doses between 3 and 6 months
IV	2 doses between 6 and 9 months
V	3 doses between 3 and 9 months

Oral polio vaccine was usually given at the same time as the triple vaccine, but infants 05 and 31 were immunised at other times. Infants 10, 04 and 22 also received BCG inoculations during the study, the latter because she was a suspected tuberculosis contact.

SECTION B - GENERAL HAEMATOLOGY

1) Total Cell Numbers

Table 3 - 9 shows the total white blood cell (WBC) counts on heparinised blood from breast- and bottle-fed infants respectively. The means (\pm SD) are plotted in Fig.3 - 1. There were no significant differences between the WBC counts of breast- or bottle-fed infants on any sample occasion. WBC counts ranged from 6.7 - 19.9 x 10³/ml at 6 days (mean 12.3 x 10³) and then fell to 6.1 - 11.9 x 10³ (mean 9.8 x 10³) by 6 weeks. These values were comparable to those found in normal infants by other workers (Dallman, 1977; as shown in Table 3 - 9). Fig.3 - 1 shows a large increase in the mean WBC count in breast-fed infants at 6 months. The difference between the two feeding groups was not significant, (P=0.053). Examination of the data on individual

infants shown in Table 3 - 9, indicated that 5 infants had very high counts ($>13 \times 10^3$) at that time. Comparison of the WBC count with the health of the infant shown in Table 3 - 6 showed that all infants with high WBC counts had suffered an infectious episode within 10 days of sample collection (or immediately after, infant 07). Examination of other infants 6 weeks or older with WBC counts $>13 \times 10^3$ (Table 3 - 10) showed that 12/15 samples were collected within 3 weeks of a documented infection. However there were also many samples from infants with current or recent infections who had WBC counts below the mean values.

2) Differential WBC Numbers

Percentages of neutrophils, lymphocytes, monocytes and eosinophils were also measured (Table 3 - 11), and the means of neutrophil and lymphocyte numbers are plotted in Fig 3 - 2. The percentage of lymphocytes present rose from 50 to 70% by 6 weeks and fell to 65% between 6-9 months. Polymorphonuclear cells fell correspondingly from 35 to 20% and rose to 25% by 9 months. Monocyte numbers were low, 5-10%, and eosinophils constituted only 1-3% of the WBC. These numbers are within the normal range, as shown in Table 3 - 11 and there were no significant differences between the two feeding groups. Infant 08 had a high eosinophil count at 9 months (24%), this infant suffered from food allergies. Curiously, the eosinophil numbers were low while the eczema symptoms were at their worst (up to 7 months).

TABLE 3 - 9

TOTAL CELL COUNTS IN BREAST- AND BOTTLE-FED INFANTS

INF NO.	BREAST					INF NO.	BOTTLE				
	1 WK	6 WKS	3 MTH	6 MTH	9 MTH		1 WK	6 WK	3 MTH	6 MTH	9 MTH
02	13.5*	11.6	13.3	14.6	17.9	01	6.7	9.4	12.6	10.5	11.4
03	-	7.0	10.7	9.4	6.9	04	12.7	7.7	15.0	13.5	10.3
05	14.3	11.9	7.0	17.8	9.0	13	15.6	11.0	13.2	11.9	9.1
06	9.7	8.4	7.7	9.0	7.2	15	13.4	8.4	7.7	7.5	6.4
07	15.8	8.5	7.7	17.8	8.1	16	16.7	8.5	8.2	6.7	8.2
08	14.7	11.2	13.1	11.8	10.0	19	14.3	8.5	7.1	8.8	10.2
09	11.8	10.7	8.3	11.0	8.5	20	12.3	11.8	8.0	9.7	12.9
10	9.3	7.0	6.3	7.0	7.5	22	10.5	10.9	9.0	10.9	7.3
11	14.6	11.8	8.9	-	13.9	23	9.2	11.0	8.6	13.3	11.3
12	7.4	6.1	6.8	7.7	9.4	24	12.3	11.1	11.4	12.3	15.5
14	10.6	9.9	10.1	7.7	7.9	25	11.6	10.6	7.7	7.7	7.9
17	13.0	12.5	13.2	15.9	15.9	26	19.9	10.3	9.0	7.1	7.8
18	10.8	11.6	15.1	13.1	-	28	10.7	7.8	7.8	9.0	8.4
27	12.4	9.1	9.5	12.7	7.8	29	9.7	8.1	6.9	9.2	6.8
31	11.5	10.0	9.4	10.6	5.1	30	11.9	9.4	11.8	7.1	8.7
MEAN	12.1	9.82	9.8	11.8	9.67		12.5	9.63	9.6	9.68	9.5
SD	2.3	2.1	2.8	3.5	3.5		3.2	1.4	2.5	2.3	2.5
NORMAL RANGE**							MEAN	12.2	10.8	11.9	
							95% C.I.	(5-21)	(5-19.5)	(6-17.5)	

- = Not tested

* WBC counts $\times 10^3/\text{ml}$

** Figures from Dallman, P.R., In Paediatrics, 16th Edn. Rudolph, A.M. (ed)
New York Appleton-Centurycrofts Inc. 1977

Figure 3 - 1

White blood cell numbers in infant blood

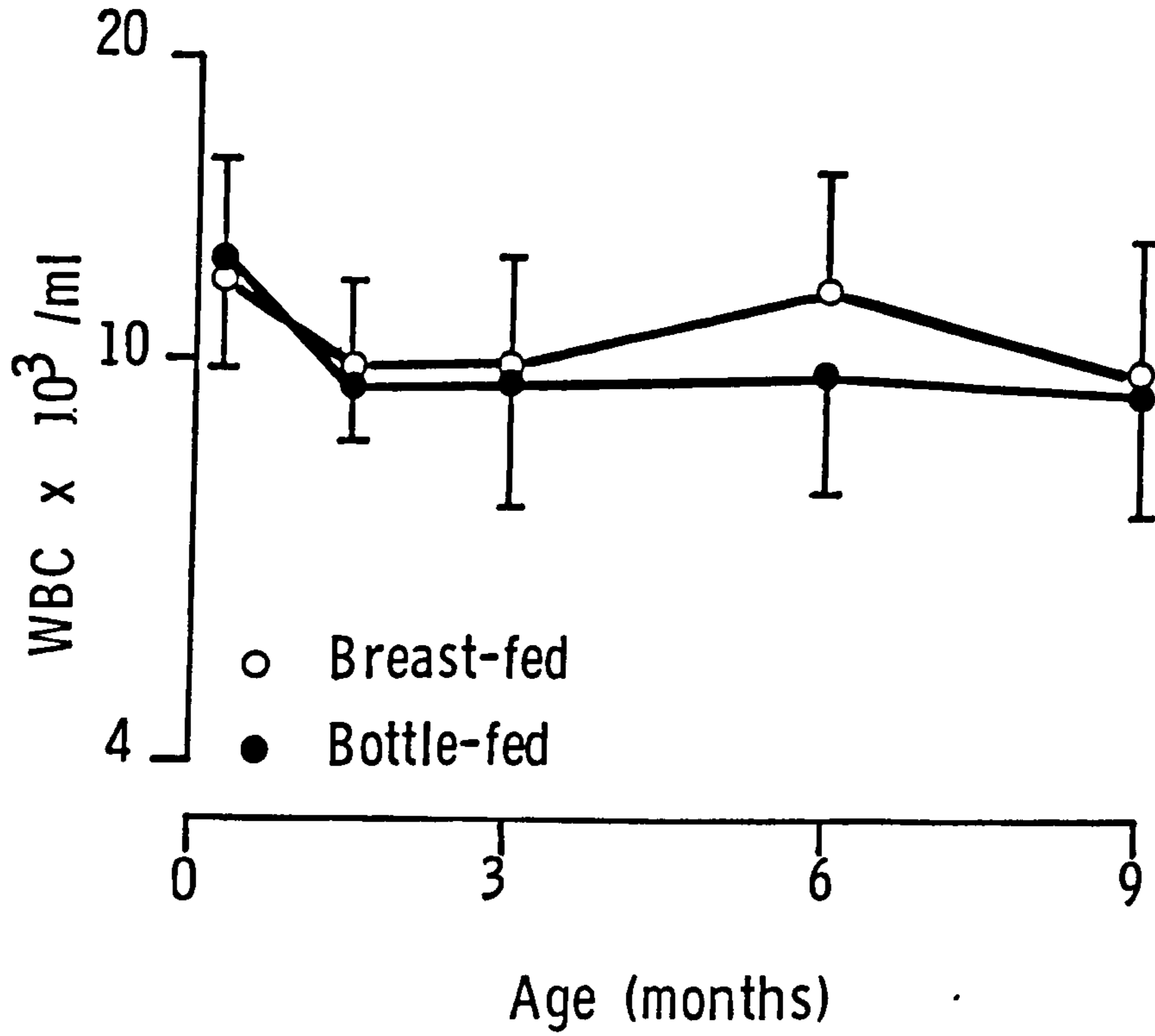


Figure 3 - 2

Percentages of lymphocytes and neutrophils in infant blood

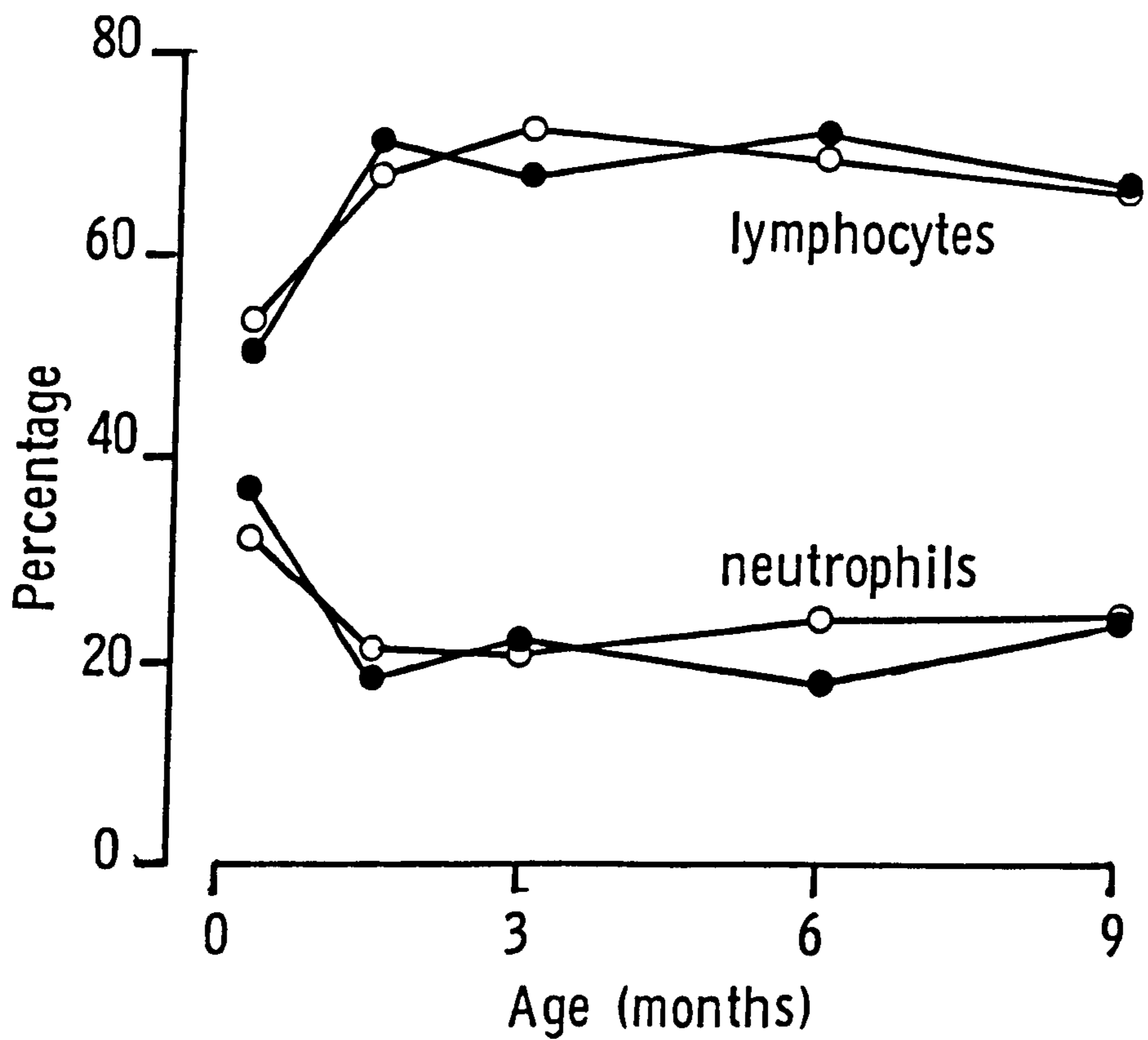


TABLE 3 - 10

RELATIONSHIP OF HIGH WBC NUMBERS TO RECENT INFECTIONS

INFANT NUMBER	AGE (MTHS)	WBC X10 ³	% LYMPHS	INFECTION	TIME OF INFECTION RELATIVE TO SAMPLE
BREAST-FED					
02	6	14.6	79	URTI	1 WEEK PREV.
	9	17.9	62	NO INF. RECORDED	
05	6	17.8	40	URTI	1 WEEK PREV.
07	6	17.8	68	CHICKEN POX	3 DAYS LATER
11	9	13.9	44	URTI	1 WEEK PREV.
17	3	13.2	72	URTI + DIARRHOEA	10 DAYS PREV.
	6	15.9	76	URTI	10 DAYS PREV.
	9	15.9	69	VIRAL INFECTION	3 WEEKS PREV.
18	3	15.1	64	URTI	7-10 DAYS PREV.
	6	13.1	61	URTI	10 DAYS PREV.
BOTTLE-FED					
04	3	15.0	66	NO INF PREV 2 MTH	
	6	13.5	72	URTI	3 WEEKS PREV.
13	3	13.2	68	MILD URTI	1 WEEK PREV.
23	6	13.3	70	NO INF RECORDED	
24	9	15.5	61	URTI	1 WEEK PREV.

TABLE 3 - 11
TOTAL LEUCOCYTE NUMBERS

	1 WEEK	6 WEEKS	3 MONTHS	6 MONTHS	9 MONTHS
<u>NEUTROPHILS(%)</u>					
BREAST-FED (±SD)	32.6 (20-45)	21.3 (15-28)	21.1 (13-29)	24.1 (13-35)	23.4 (12-34)
BOTTLE-FED	37.4 (27-48)	19.0 (13-25)	22.5 (17-28)	18.1 (12-24)	24.4 (18-31)
NORMAL*	45	35		32	
<u>LYMPHOCYTES(%)</u>					
BREAST-FED	53.7 (38-70)	67.8 (60-76)	72.1 (63-81)	69.9 (58-82)	7.6 (55-80)
BOTTLE-FED	50.4 (40-60)	71.1 (62-80)	67.8 (62-74)	72.5 (65-80)	66.7 (59-74)
NORMAL	41	56		61	
<u>MONOCYTES(%)</u>					
BREAST-FED	10.8 (4-18)	9.0 (3-15)	5.2 (2-9)	4.7 (2-7)	5.4 (2-8)
BOTTLE-FED	9.4 (6-13)	7.2 (1-13)	7.2 (3-11)	6.9 (3-11)	7.1 (3-11)
NORMAL	9	7		5	
<u>EOSINOPHILS(%)</u>					
BREAST-FED	3 (1-5)	2 (0-3)	1.5 (0-3)	1 (0-3)	3.6 (0-10)
BOTTLE-FED	3 (1-5)	2 (0-4)	2.5 (0-5)	2.5 (0-5)	2 (0-4)
NORMAL	4	3		3	

* Figures from Dallman, PR. In Paediatrics, 16th Edn.

Rudolph, AM. (ed) New York Appleton-Century-Crofts Inc. 1977

TABLE 3 - 12

SUMMARY OF ANALYSIS OF QUESTIONNAIRES

	MATERNAL AGE (YEARS)	% SOCIAL CLASS		NO. SIBS	INFECTIONS (MEAN/INFANT)			ECZEMA (TOTAL)
		I&II	III&IV		URTI	DIARRHOEA	OTHER	
BREAST	31.3	87	13	1.2	3.3	0.4	0.6	1
BOTTLE	27.3	27	73	0.7	2.3	0.47	0.47	3
P =	0.019	<0.01		0.43	0.22			
correlation P =		0.053		0.031				

SECTION C - DISCUSSION

1) Family Differences Between Feeding Groups

Analysis of the questionnaires has shown a number of differences between the families of the two groups of infants, summarised in Table 3 - 12. First, the mean maternal age was 4 years higher in the breast-feeding group, second the number of siblings was greater in this group and third, there were more families in the higher Social Classes in the breast-fed group than the bottle-fed group. These differences were in part due to a sampling problem. The enthusiasm of the NCT counsellors meant that there was no shortage of pregnant ladies intending to breast-feed who were keen to be involved in the study. However, because of the strong encouragement at NPH for all mothers to try to breast-feed, (80-90% attempt breast-feeding), it was fairly difficult to match the breast-fed infants with completely bottle-fed infants born around the same time, from families of similar size, age, etc. The general trend of mothers in the higher Social Classes to breast-feed and those in the lower Social Classes to bottle feed their infants, increased this selection problem.

Are these family differences important? Certainly in studies with much larger sample sizes, favourable family situations (including higher maternal age and Social Class) have been related to lower infection rates (see Chapter 1). In this relatively small study however, the URTI rate was higher in the supposedly more favourable group (although this difference was not significant). One reason for this may be that the older age of the mothers in the breast-feeding group was associated with more siblings in this group. The association of feeding group with sibling number was not significant

but this higher number of siblings undoubtedly resulted in a higher exposure rate of the infants to infectious agents brought home from playgroups etc. and sibling number was significantly correlated with the incidence of URTI's. The infants remaining free from infections tended to be those without siblings and there were only two such infants in the breast-fed group. Other studies have also shown a correlation between sibling number and infection rates (Pullan *et al*, 1980; Holmes, Hassanein and Miller , 1983).

2) Role of Social Factors in Infection Rates

The relationship between other family factors and infection rates in breast- and bottle-fed infants has been investigated by a number of workers (Cunningham, 1979; Watkins, Leeder and Corkhill, 1979; Pullan *et al*, 1980; Bloom, Goldbloom and Stevens, 1982; Taylor *et al*, 1982; Holmes, Hassanein and Miller, 1983).

A criticism often levelled at breast- versus bottle-feeding studies is that it is mainly Social Classes I and II that breast-feed and Social Classes III and IV that bottle-feed, and therefore other factors unrelated to the method of feeding could affect any observed differences in infant health. Although the families in this study certainly tended to support this observation, many of the bottle-feeding mothers whose husband's occupation classified the family as Social Class III, had themselves either recently given up or were intending to continue with jobs such as nursing and teaching which are classified as Social Class II. It is therefore questionable whether classifications which take no account of the education or employment of the mother (who for the purposes of this study must be more important than the father) have much value in assessing the home

environment of the infants. A more valuable assessment may have been to attempt to assess maternal care and home environment as has been done on more extensive studies on lower respiratory infections (Pullan *et al*, 1980). These studies have shown an association between maternal education, home environment and maternal care with infection rates. Breast-feeding is usually associated with the more favourable family situations but even when these factors are corrected for, a benefit of breast-feeding in lowering infection rates can still be seen (Watkins *et al*, 1979).

To assess home environment in this study would have involved considerable cooperation from health visitors and was felt unnecessary for this relatively small study on immunological aspects of the infants. All homes were visited during the study, and home environments were considered 'satisfactory to good' in all families. The extensive involvement of the mothers and infants required for the study tended to select families who were enthusiastic and interested in the health and well-being of their infants, and maternal care was considered uniformly good, regardless of the method of feeding.

3) Breast-feeding Does Not Fully Protect the Infant

i) Infections

The number of infants in this study was too small to make any general comments on infection rates in breast- and bottle-fed infants, and the strong correlation of sibling number with upper respiratory infections may have masked any beneficial effects of breast-feeding. However the fact that there were 19 URTI episodes which occurred in exclusively breast-fed infants indicates that these infants were not being fully protected by breast milk, an observation made in other studies (Pullan

et al, 1980).

Although other infections during the study were infrequent, once again breast milk was not fully protective, as infection rates were no lower in breast-fed infants. This was true even for episodes of diarrhoea.

ii) Allergies

It is also impossible to comment generally on the relative frequency of allergies in such a small study. It is clear, however, that allergens can be transferred to the infant via breast milk, causing problems in atopic infants. This has been demonstrated by other workers for antigens such as cow milk proteins (Jacobsson and Lindberg, 1978). In addition, Allardyce and Wilson (1984) have shown that breast milk cells from atopic mothers secrete factors which stimulate cord blood lymphocytes to secrete IgE *in vitro*. These factors might also have an effect on allergic reactions in breast-fed infants.

4) WBC counts and Infections

All infants had total WBC numbers within the normal ranges established by other workers. However, some infants showed a transient large increase in WBC numbers, usually associated with recent or current infections. The converse was not true as infections were not always associated with an increase in neutrophil or lymphocyte numbers. Other studies have also indicated that the WBC count in early infancy does not necessarily reflect the infective state of the infant (Rasmussen and Rasmussen, 1982).

SUMMARY

Breast-feeding was associated with significantly higher maternal age and Social Class than bottle-feeding, factors generally considered more favourable as far as infant care is concerned. However, there were also more older siblings in the breast-feeding group and there was a significant association between this higher sibling number and increased upper respiratory infections in the breast-fed infants, although these differences in sibling number and URTI rate between the groups were not significant. This increased exposure rate of the breast-fed infants may have masked any protective benefits due to breast-feeding.

There were no significant differences between the feeding groups in family medical history, infant gestational age, birthweight, sex, total WBC numbers, leucocyte differential counts or infectious episodes. For the purposes of this study on the immunological benefits of breast-feeding therefore, these two groups were considered comparable, and any differences found in immune function between the groups could be attributed to feeding.

CHAPTER 4

MONONUCLEAR CELL PROLIFERATION *IN VITRO*

SECTION A - INTRODUCTION

Human milk contains several factors which can influence cell growth and function *in vitro* (see Chapter 1). These include lymphokines such as γ -interferon, lymphocyte derived chemotactic factor (Keller *et al.*, 1981) and prostaglandins E and F (Lucas and Mitchell, 1980; Blau *et al.*, 1983) together with growth promoting factors for epithelial cells such as epidermal growth factor (Carpenter, 1980). Whether these factors have a similar growth stimulating effect *in vivo* on cells of the breast-fed infant is not known. By studying infant mononuclear cell proliferation and function *in vitro*, it was hoped to determine whether these cells had been affected in any way by the constant intake of these factors in breast milk.

When peripheral blood mononuclear cells (PBM) are cultured *in vitro*, a small number will proliferate spontaneously. The rate of proliferation can be measured by addition of ^3H -thymidine to the culture medium for a fixed time interval; the amount incorporated into the DNA is proportional to the rate of proliferation. A number of substances have been identified which, when added to these mononuclear cell cultures, stimulate further proliferation of a proportion of these cells. For this present study, a range of stimuli were chosen which were known to affect different populations of PBM cells (see Chapter 1). Phytohaemagglutinin (PHA) stimulates primarily T cells, pokeweed mitogen (PWM) acts on both T and B cells, whereas *Staph.aureus* strain Cowan (SAC) is a polyclonal B cell activator.

When mitomycin-C treated allogeneic lymphocytes are added to the cell cultures, cells will proliferate in response to the foreign histocompatibility antigens. The responding cells are primarily T cells (Kuntz, Innes and Weksler, 1976) but are thought to be a separate population from those responding to PHA (Carr, Stites and Fudenberg, 1973). Antigens, when added to PBM cultures, will stimulate only a small number of lymphocytes, those which bear Ig receptors specific for that antigen. However, it should be noted that cells stimulated to proliferate by antigens (or other stimuli), may also be stimulated to secrete lymphokines, which may in turn act on other populations and so a proportion of the response will be polyclonal.

The ability of cord blood lymphocytes (CBL) and infant peripheral blood lymphocytes (PBL) to respond to mitogens, allogeneic lymphocytes and antigens *in vitro* has been investigated using various culture techniques (see Chapter 1 and Discussion, this Chapter). Conventionally, culture media for lymphocyte studies have included serum (either FCS or human AB) which enhances growth but is itself mitogenic, giving rise to high rates of 'spontaneous' proliferation. Different batches of serum vary in their growth supporting and mitogenic activity and this complicates any further studies on the responses of cells to various T and B cell mitogens, antigens or allogeneic lymphocytes. Additional proliferation, above background 'spontaneous' proliferation, which is induced by these added stimuli, is frequently expressed as a ratio of stimulated to unstimulated proliferation. A serum-free medium has been developed by Iscove and Melchers (1978) which uses a modified Dulbecco's medium base with added supplements of lipid, transferrin and BSA. This medium supports

the growth of human lymphocytes *in vitro* and was used for all proliferation experiments in this study. The advantage is that the background stimulation is very low compared with serum-containing media, thus allowing the effects of mitogens and other stimuli to be more reliably interpreted.

Previous studies on lymphocyte proliferation have generally used single doses of mitogens or stimulators at a single concentration of responding cells and proliferation has been estimated over one fixed period during the culture. This allows a comparison of single points between different samples but these single point comparisons can be misleading as they do not indicate the dynamics of the response. Variations of stimulator doses, responding cell concentrations and days of culture for harvesting have all been shown to have substantial effects on proliferative responses (Stites *et al.*, 1972; Wara and Barrett, 1979; Farrant *et al.*, 1980). Therefore a difference between two samples estimated by single points may in fact be due to a shift in the dynamics of the response rather than the absolute magnitude; for the sample indicating a lower response, the maximal response may actually be similar (or even higher) but occurring earlier or at a lower cell concentration. Because of these multiple effects, it was decided that in order to compare the responses of cells from breast- and bottle-fed infants, it was important to know whether the speed, amplitude or cell kinetics varied between the groups. The recent development of Terasaki plate microculture techniques (O'Brien *et al.*, 1979) allowed multiple variables to be tested using very small numbers of cells.

SECTION B - METHODS AND STANDARDISATION OF CULTURE CONDITIONS

Peripheral blood mononuclear cells were separated from heparinised blood and cultured in serum-free medium (Flow Laboratories) in Terasaki plates as described in Chapter 2. Although the Terasaki plate microculture system enabled a number of variables to be tested on small quantities of blood, it was obviously not practical to test wide ranges of cell concentrations, stimulator doses, and harvest days. Yet all these variables have been shown to affect the results obtained in proliferation experiments (Farrant *et al.*, 1980). In order to assess the kinetics of the responses to the stimulators selected in the Terasaki plate system with serum-free medium, the following preliminary experiments were conducted.

1) Doses of stimulators

Because of the difficulty in obtaining large quantities of cells from healthy infants, some of these initial titrations were performed using adult cells. Each stimulator was tested at a range of dilutions, using several responder cell concentrations and days of harvest. In order to illustrate the interrelationships between stimulator concentration, responder cell concentration and time of culture, these titrations are expressed as three-dimensional graphs. To indicate numerically the relative strength of the responses conventional two-dimensional graphs are also presented.

i) PHA

The proliferative responses of PBM cells from an adult donor, to a range of doses of PHA, are shown at different responder cell concentrations in Fig 4 - 1 and 2. The effects of the same PHA

concentrations, but measuring proliferation on different days after stimulation are shown in Fig 4 - 3. These profiles show that different mitogen concentrations (between 0.5 and 5.0 μ g/ml) will induce maximal proliferation, depending on the harvest day or cell concentration chosen. An intermediate dose of 1 μ g/ml was chosen for the proliferative response investigations in infants.

ii) PWM

Responses of adult cells to a range of PWM concentrations were less variable than the PHA driven responses and are illustrated by cell concentrations (Figs 4 - 4 and 5) and by days of culture (Fig. 4 - 6). Although the maximal proliferative response was obtained with 0.1 μ g/ml, the response to doses between 0.5 - 5 μ g/ml was strong and fairly constant, and an intermediate concentration of 1 μ g/ml was chosen for the studies on proliferative responses in infants.

iii) *Staph.aureus* (strain Cowan) (SAC)

Fig 4 - 7 shows the responses of various concentrations of adult PBM cells, harvested on different days of culture, to serial dilutions of the preparation of SAC. A dilution of 1/2000 gave a maximal response at all cell concentrations and days of harvest and was used subsequently.

iv) Allogeneic lymphocytes (Mixed lymphocyte reaction - MLR)

Mitomycin-C treated Cla-4 stimulator cells were diluted to give cell concentrations from 0.5 to 4 x 10⁶ cells/ml, as estimated by the cell count prior to freezing. Estimation of viability by trypan blue dye exclusion, indicated that only between 65-70% of these cells were viable. Duplicate control wells with stimulator cells only, indicated that these cells did not proliferate during the MLR assay. Figs 4 - 8

and 9 indicate that the maximal response with adult cells occurs with $1 - 2 \times 10^6$ stimulator cells/ml. A similar titration experiment was performed using cells from a 3 week old breast-fed infant. Cells were harvested on day 3 and day 4 of culture only (Fig. 4 - 10). As with the adult cells, the maximal responses occurred with a stimulator cell concentration of between $1 - 2 \times 10^6$ cells/ml, and a dose of 2×10^6 was chosen for the study.

v) Tetanus toxoid (TT)

The average results of three TT titration experiments in 6 week old infants are shown in Fig. 4 - 11. The maximal response on each harvest day occurred with a dose of 0.001 Lf units/ml and this dose was used in subsequent proliferation experiments.

2) Responder cell concentrations

As can be seen from the stimulator titrations using adult cells, variation in responder cell concentrations can give enormous variation in the proliferative responses, and responses are not always greatest at the highest cell concentrations. The responses of varying concentrations of infant lymphocytes to all the polyclonal activators are shown plotted for differing harvest days (Fig. 4 - 12) and for each stimulant (Fig. 4 - 13). These results are the means from three experiments on infants between 10 days and 6 weeks of age. A cell concentration of 0.5×10^6 cells/ml gave little proliferative response. Maximal responses occurred with 4×10^6 cells/ml, but responses with lower cell concentrations tended to reach maximal proliferation later in the culture period. Because of these results, and the previously reported effects of varying cell concentration (Knight and Farrant, 1978) it was decided to test the infant

lymphocytes at a minimum of 3 cell concentrations ($1, 2$ and 4×10^6) and also at 8×10^6 cells/ml where cell numbers permitted.

3) Days of culture for harvesting

Proliferative responses of PBM cells from a 10 day old infant for each stimulant are shown according to the harvest day in Fig 4 - 14. Maximal response for PHA occurred between the second and third days of culture; for all the other stimuli maximal responses occurred between day four and five of culture. This was 1-2 days earlier for each stimulant than the responses of adult lymphocyte (shown for PHA, PWM and MLR in Fig 4 - 15). The harvest days chosen for the study were 3 and 5, with an extra harvest on day 4 when cell numbers permitted.

4) Statistical analyses.

The statistical analysis was similar to that employed by Harrison, Lee and Farrant (1981). Briefly, data were log-transformed to normalise the distribution and the geometric means of duplicate samples were calculated. Analysis of variance was performed on the data from each mitogen, taking into account the fact that both between-infant and within-infant sources of variation were present (Winer, 1971). Significant interactions between variables, obtained by the analysis of variance, indicate a significant modification by one variable on the effect of another variable. For example, if the two groups yield similar proliferative responses at early ages but substantially different responses at later ages, this is observed as a significant interaction between age and group in their effects on proliferation. If this phenomenon is observed at a low cell concentration but not at a high concentration, this is manifested as a

significant three-factor interaction of group, age and cell concentration.

Because of the marked lack of balance with respect to cell concentration (less observations were available at the highest cell concentrations), data were further divided into cell concentrations and the analysis of variance reapplied. This lack of balance is illustrated in Table 4 - 1, which shows the numbers of observations (infants) available for each cell concentration and day of culture at each age for the spontaneous proliferation and mixed lymphocyte reaction data. Numbers for other stimuli were intermediate between these two.

Where individual comparisons between groups were required at specific ages, days of culture or cell concentrations, Bonferroni t-tests were performed (Gill, 1978). These take into account the circumstance of multiple tests and so are rather more conservative than pooled t-tests. For the purposes of these tests, the appropriate variance estimates, derived from the analysis of variance procedure, were used. Where confidence intervals were constructed, these incorporated variability both between and within infants. Confidence intervals (95%) are shown on all figures illustrating significant interactions or differences between groups, where proliferation was averaged over several cell concentrations and/or days of culture but have been omitted from the detailed graphs for the purposes of clarity.

Figure 4 - 1

Proliferative responses of adult PBM cells to varying doses of PHA, at different cell concentrations.

■ 8×10^6 ; □ 4×10^6 ; ▽ 2×10^6 ; △ 1×10^6 cells/ml

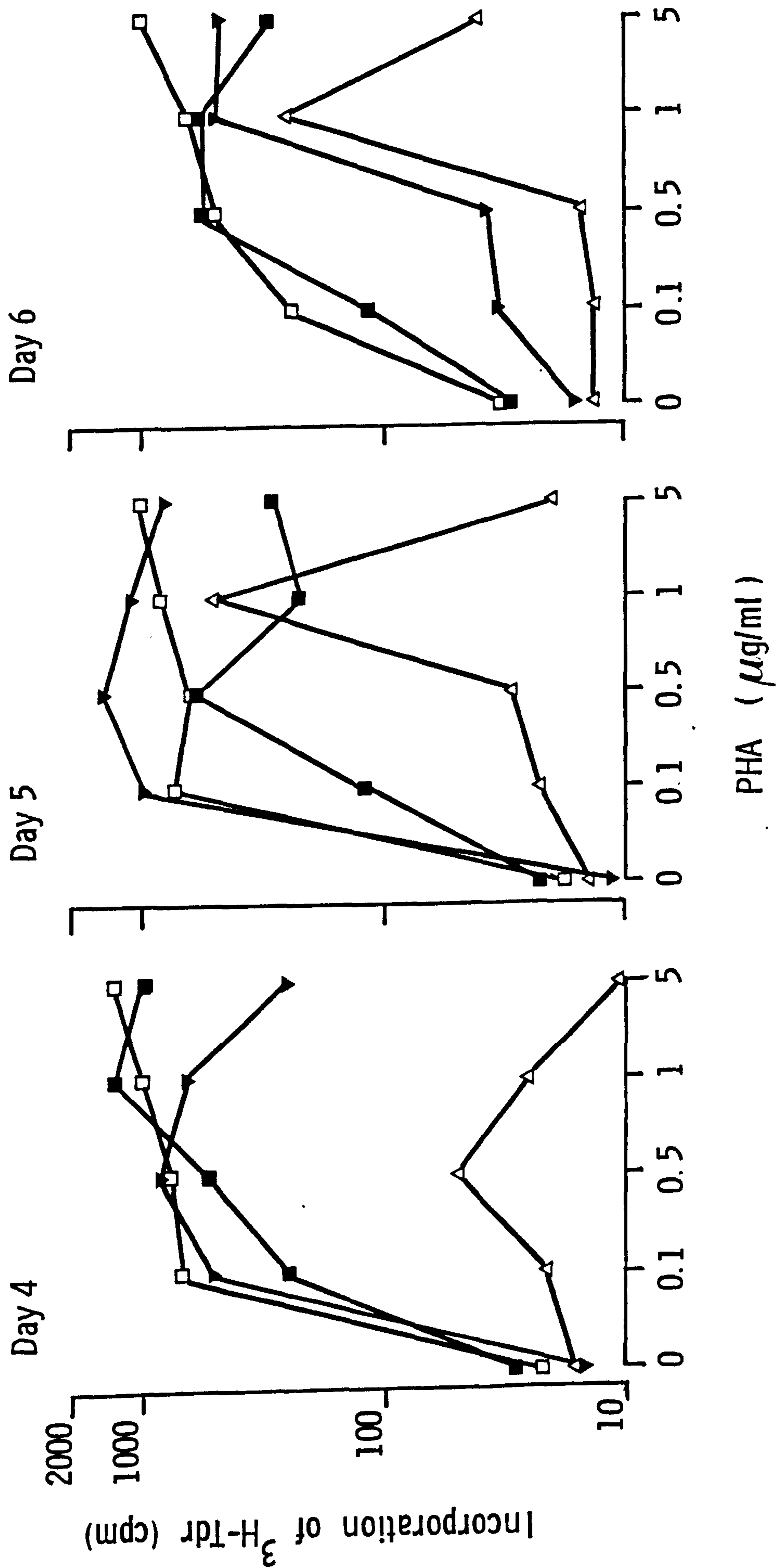


Figure 4 - 2
Three-dimensional graph of Fig.4 - 1. Height of peaks represents incorporation of ³H-Tdr.

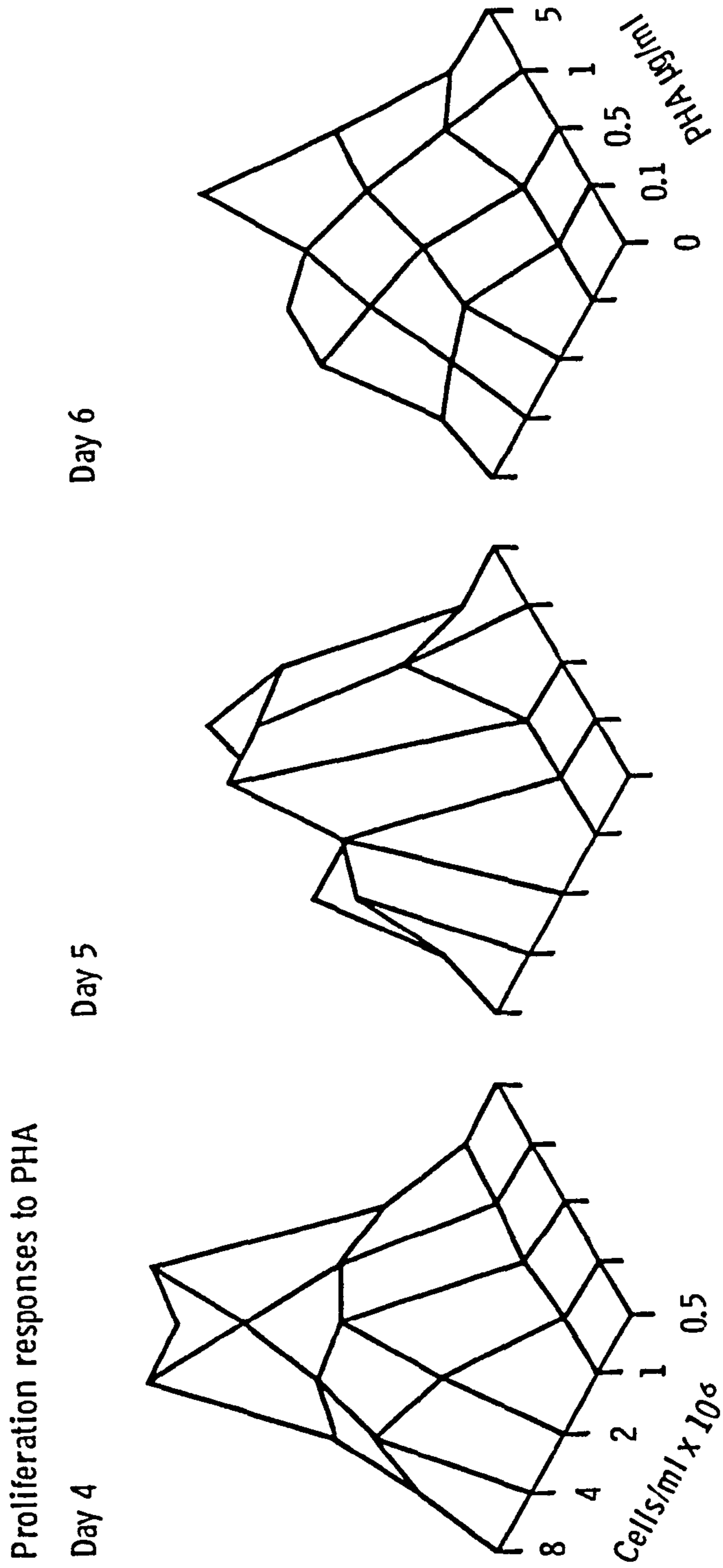


Figure 4 - 3

Proliferative responses of adult PEM cells to varying doses of PHA, harvested on different days of culture

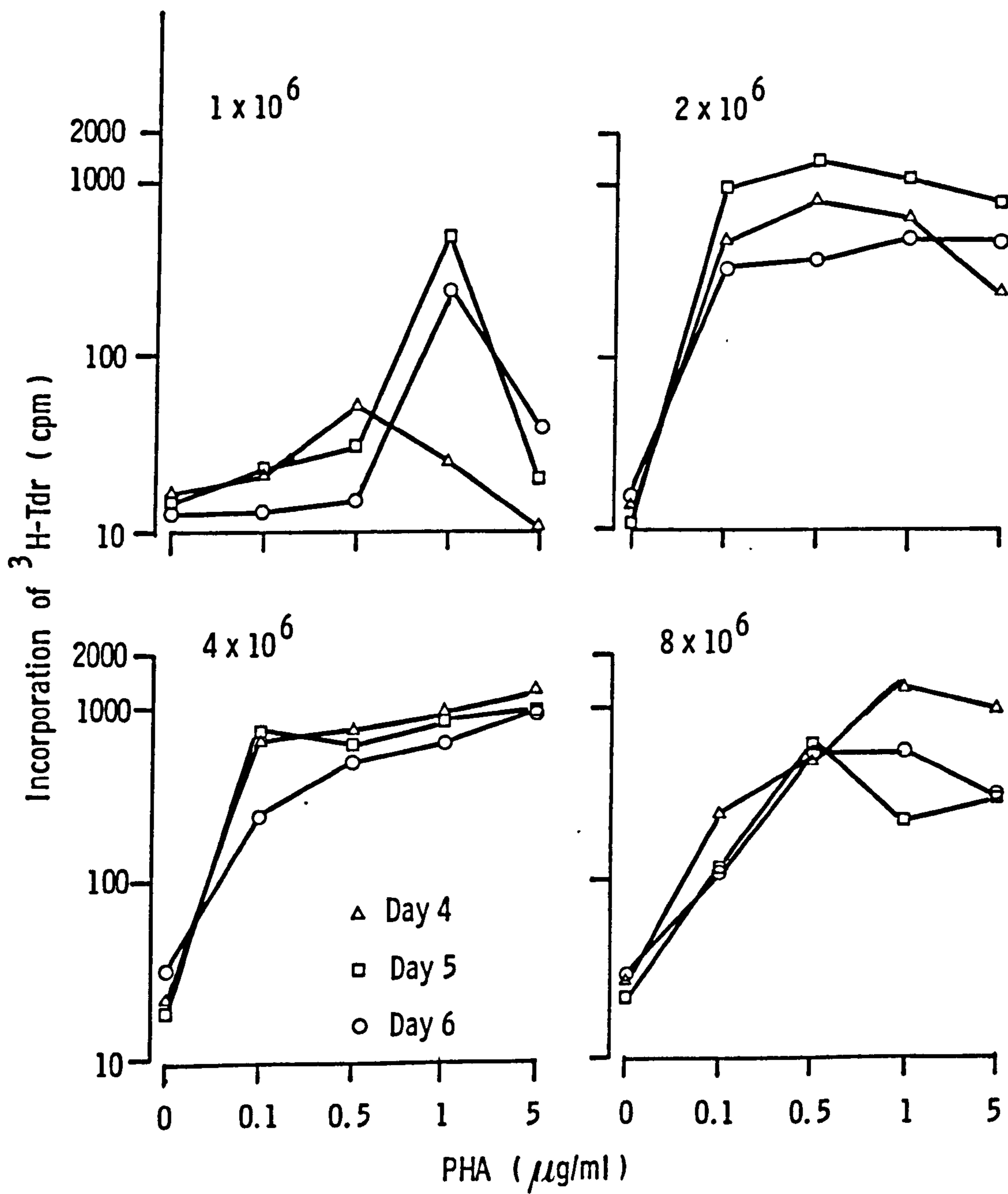


Figure 4 - 4

Proliferative responses of adult PWM cells to varying doses of PWM, at different cell concentrations.

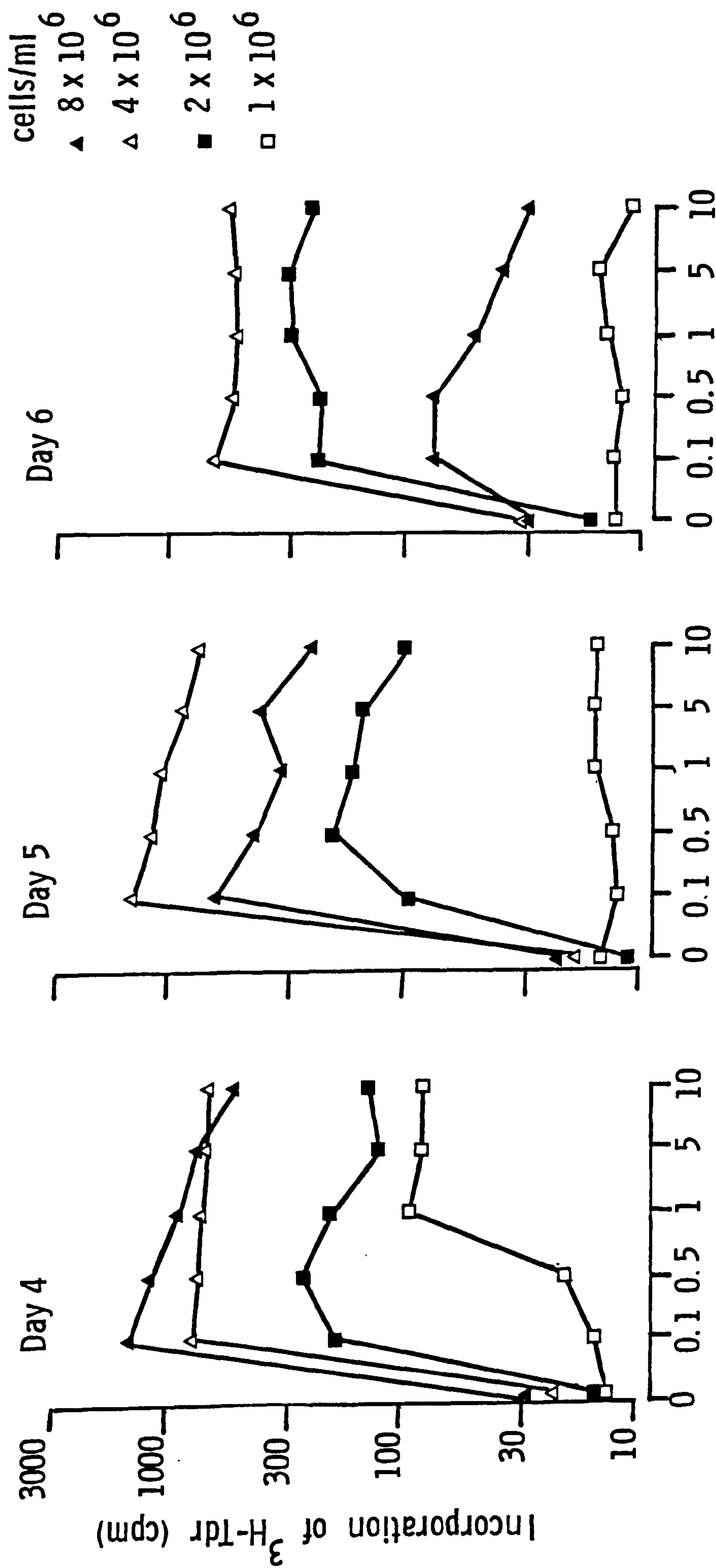


Figure 4 - 5
 Three-dimensional graph of Fig.4 - 4. Height of peaks represents
 incorporation of $^3\text{H-Tdr}$.

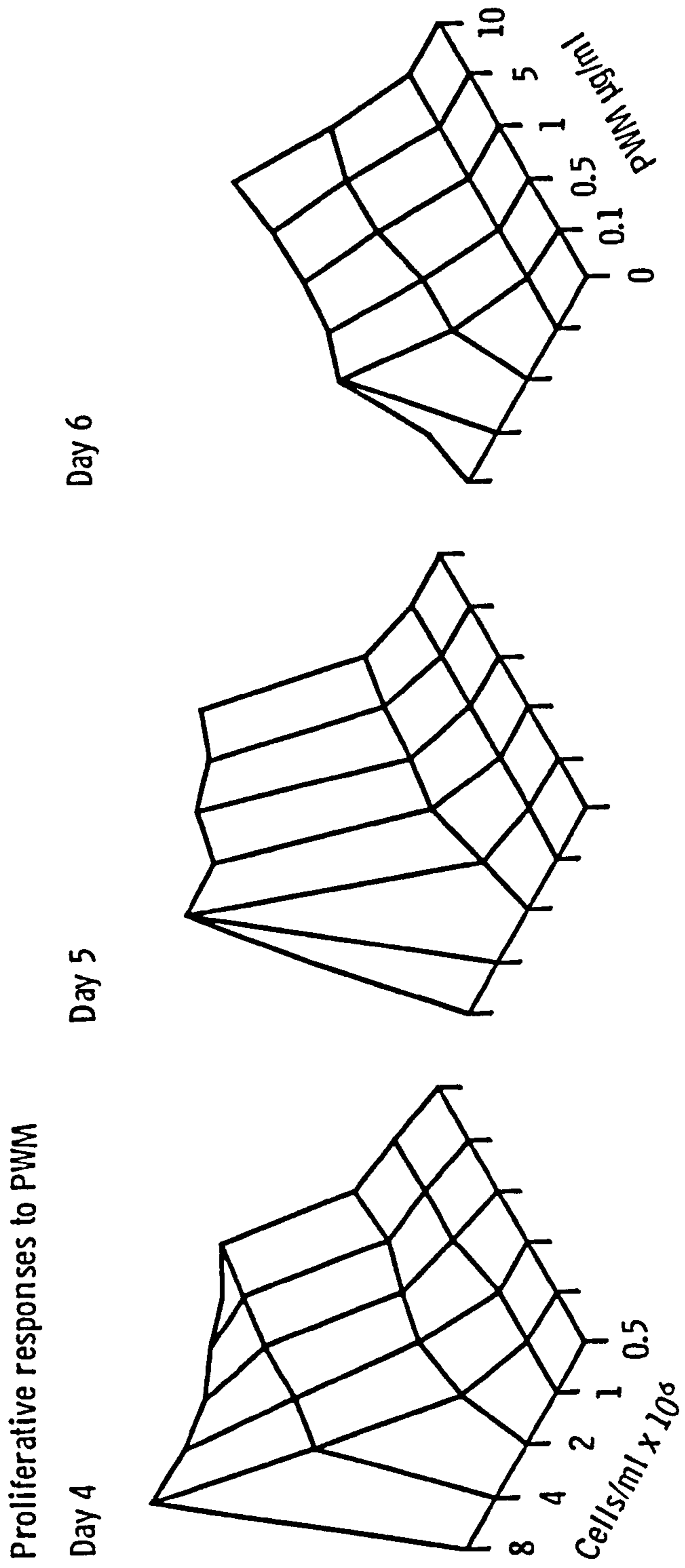


Figure 4 - 6

Proliferative responses of adult PBM cells to varying doses of PWM, harvested on different days of culture

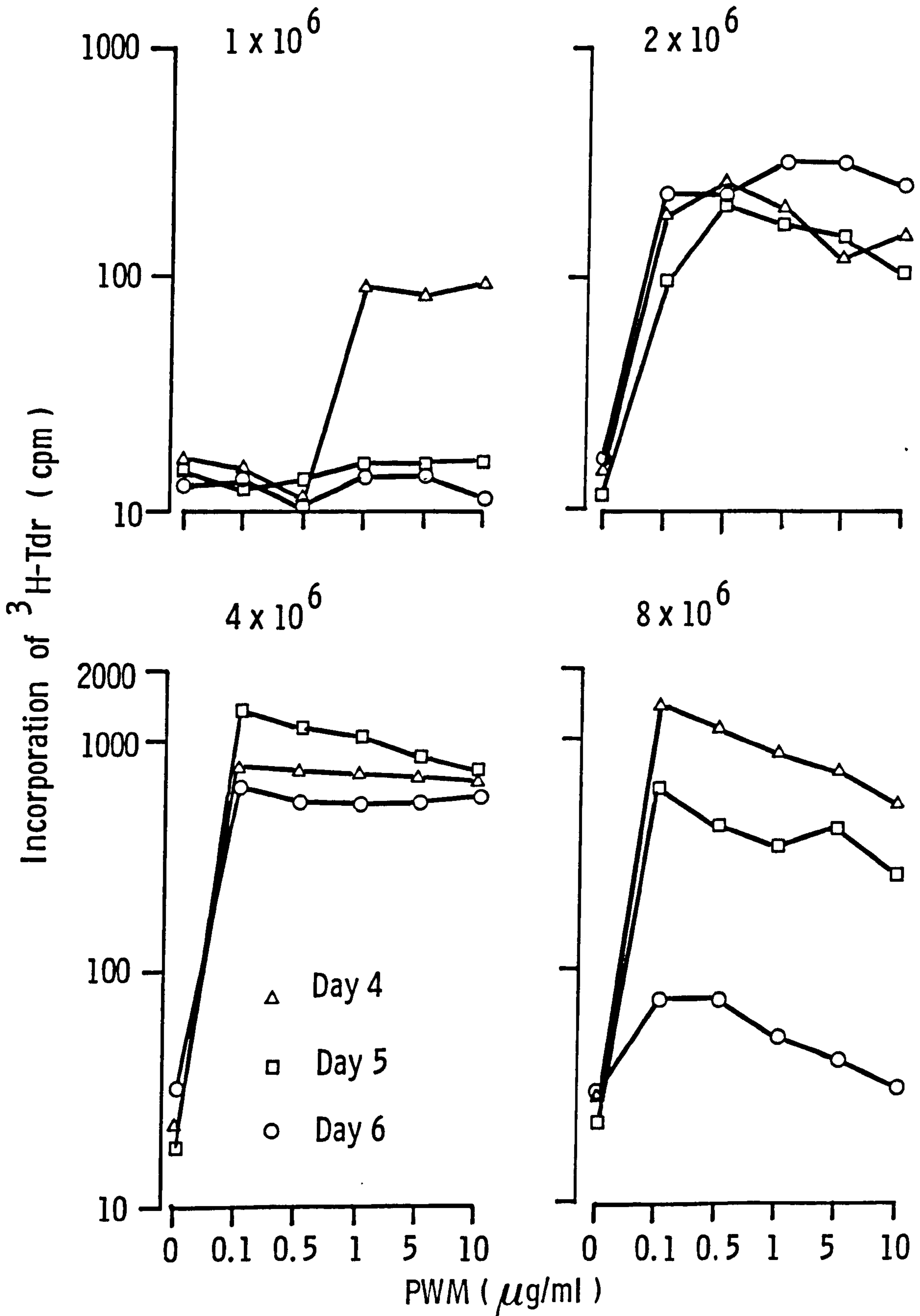


Figure 4 - 7

Proliferative responses of adult PEM cells to varying concentrations of SAC, at different cell concentrations.

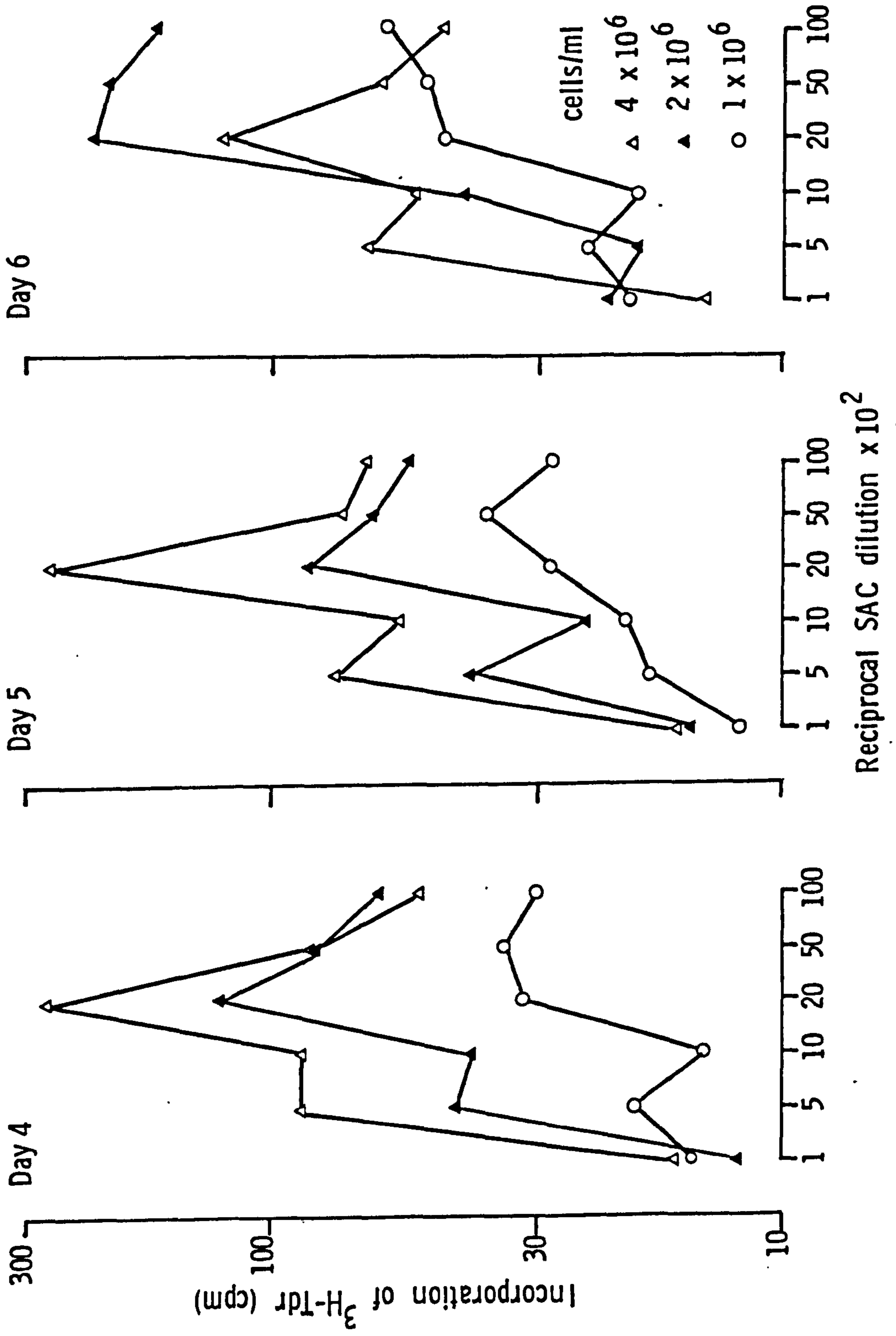


Figure 4 - 8

Proliferative responses of adult PBM cells to varying concentrations of allogeneic lymphocytes (Cla-4 B cell line) at different responder cell concentrations

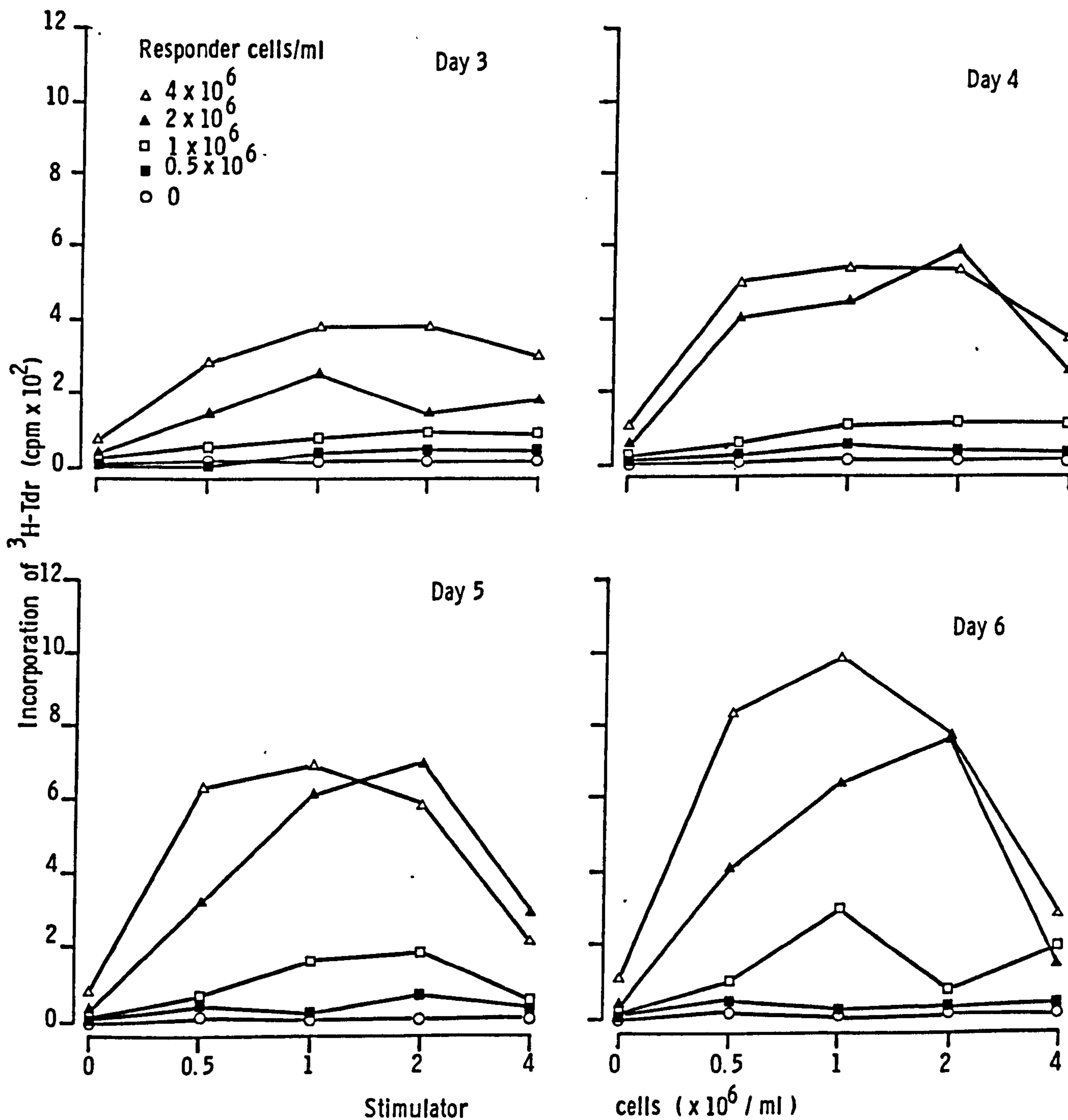


Figure 4 - 9

Three-dimensional representation of Fig.4 - 8. Height of peaks represents incorporation of $^3\text{H-Tdr}$.

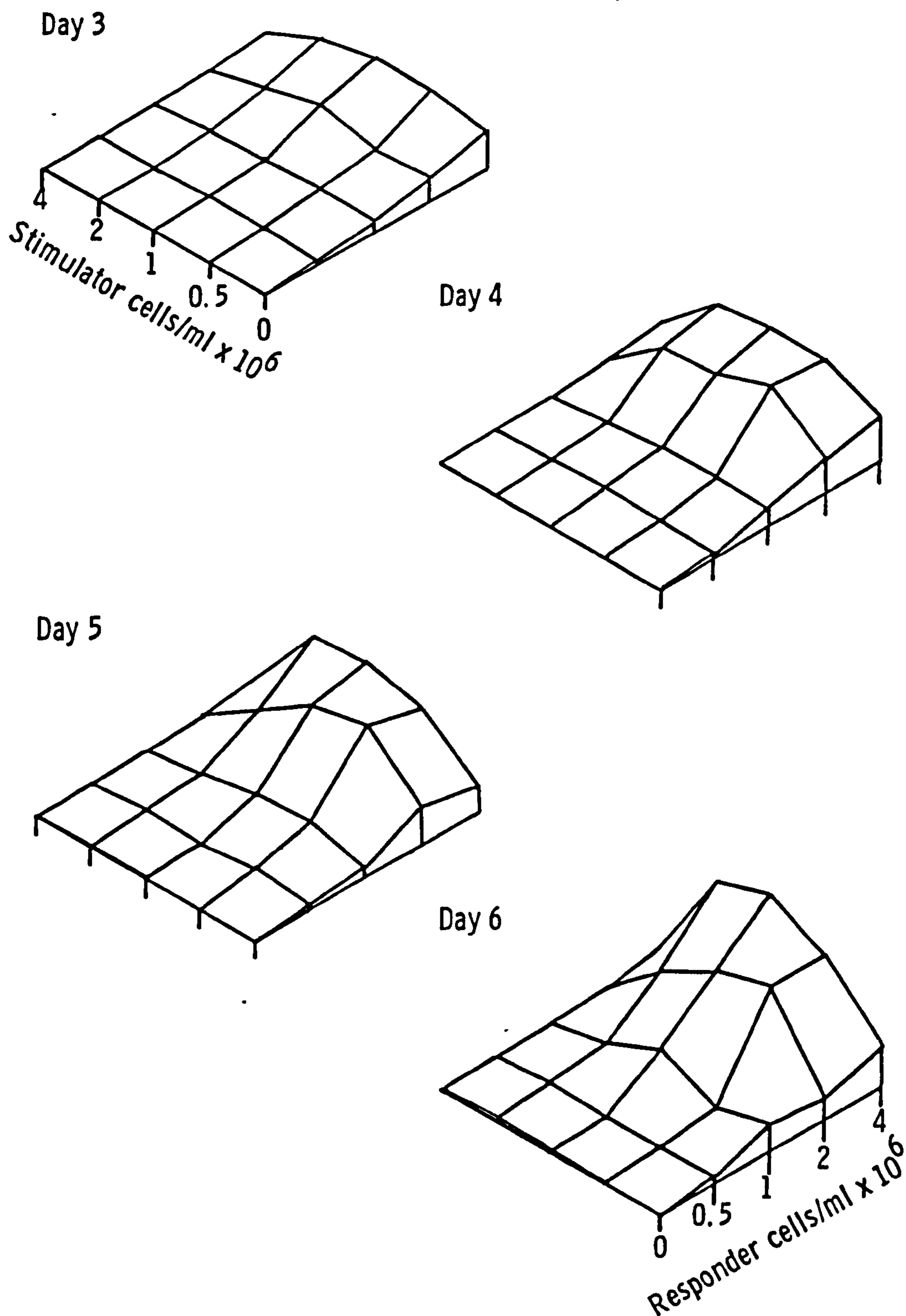


Figure 4 - 10

Proliferative responses of infant PBM cells to varying concentrations of allogeneic lymphocytes at different responder cell concentrations.

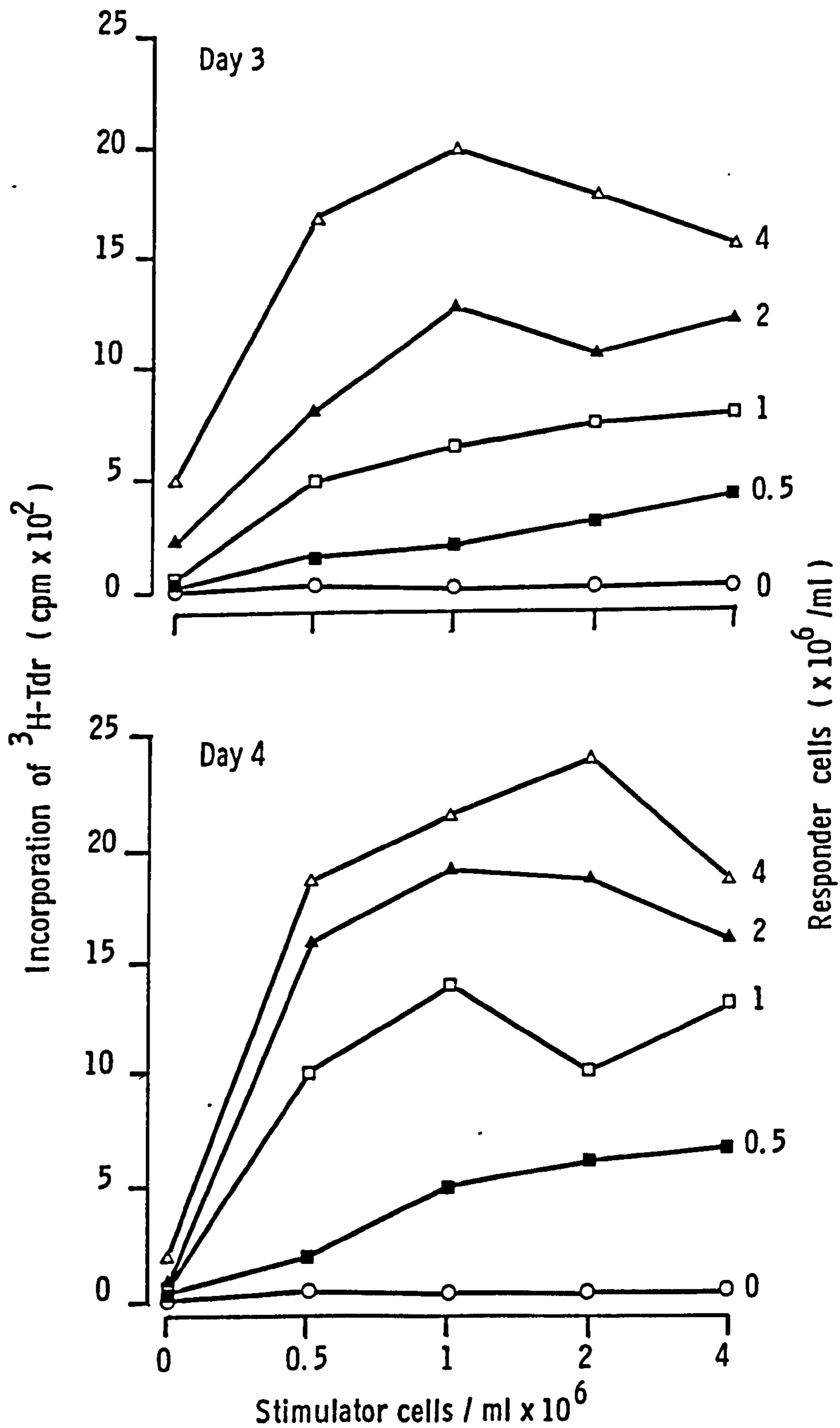


Figure 4 - 11

Proliferative responses of infant PBM cells to varying doses of TT.

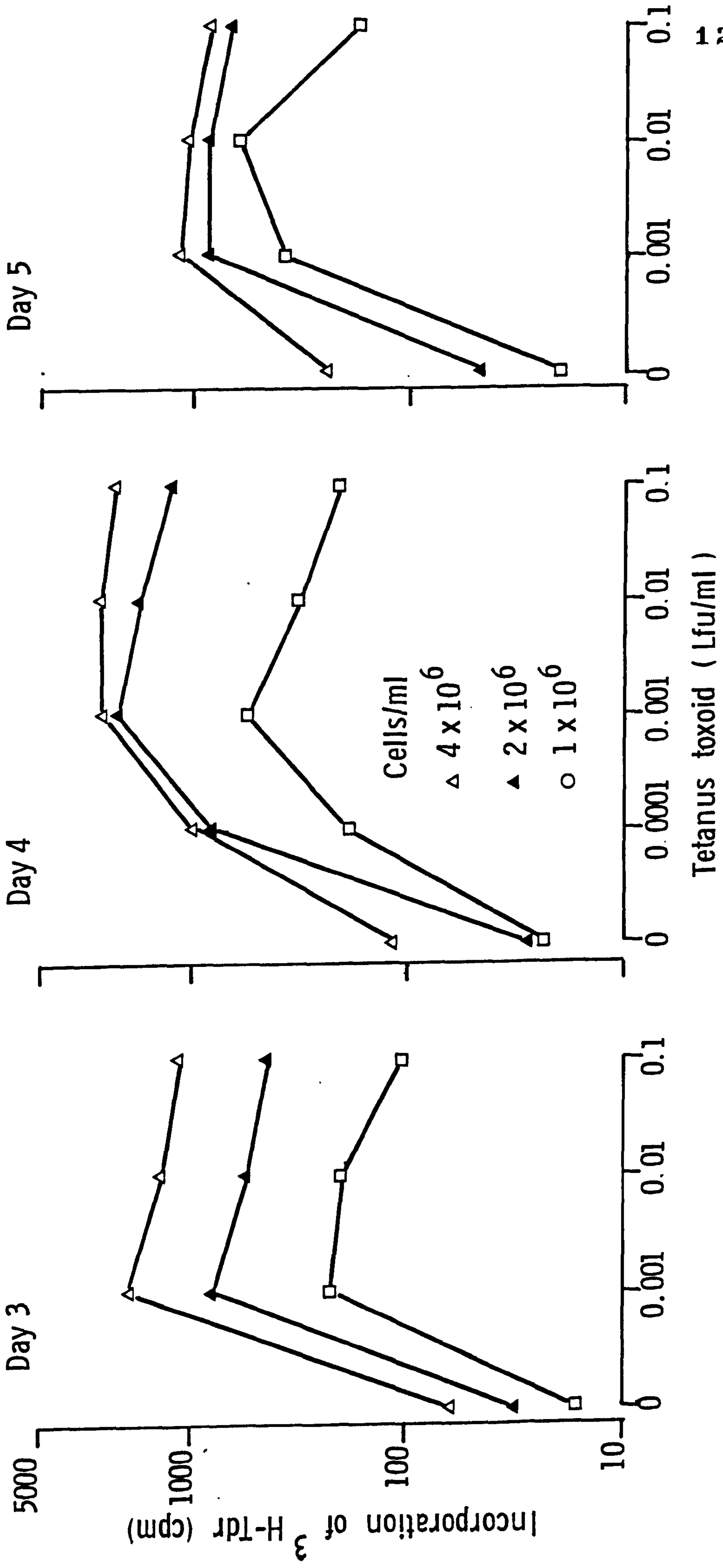


Figure 4 - 12 . Effect of responder cell concentration on proliferative responses of infant PBM cells to different stimuli :- Δ No stimulus; \square PHA; \circ PWM; ∇ SAC; \blacksquare Allogeneic lymphocytes.

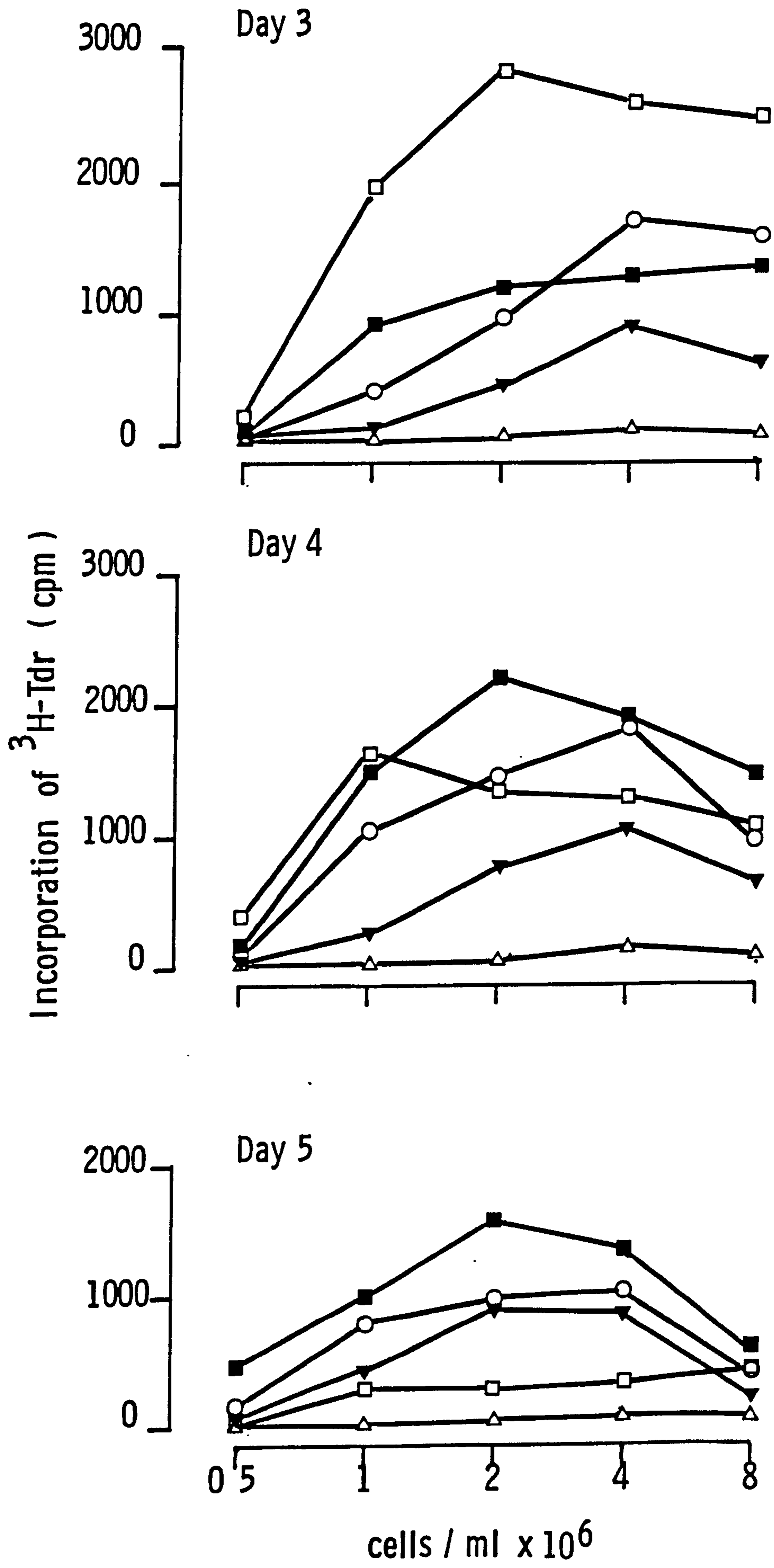


Figure 4 - 13

Effect of responder cell concentration on proliferative responses of infant PBM cells, harvested on different days of culture.

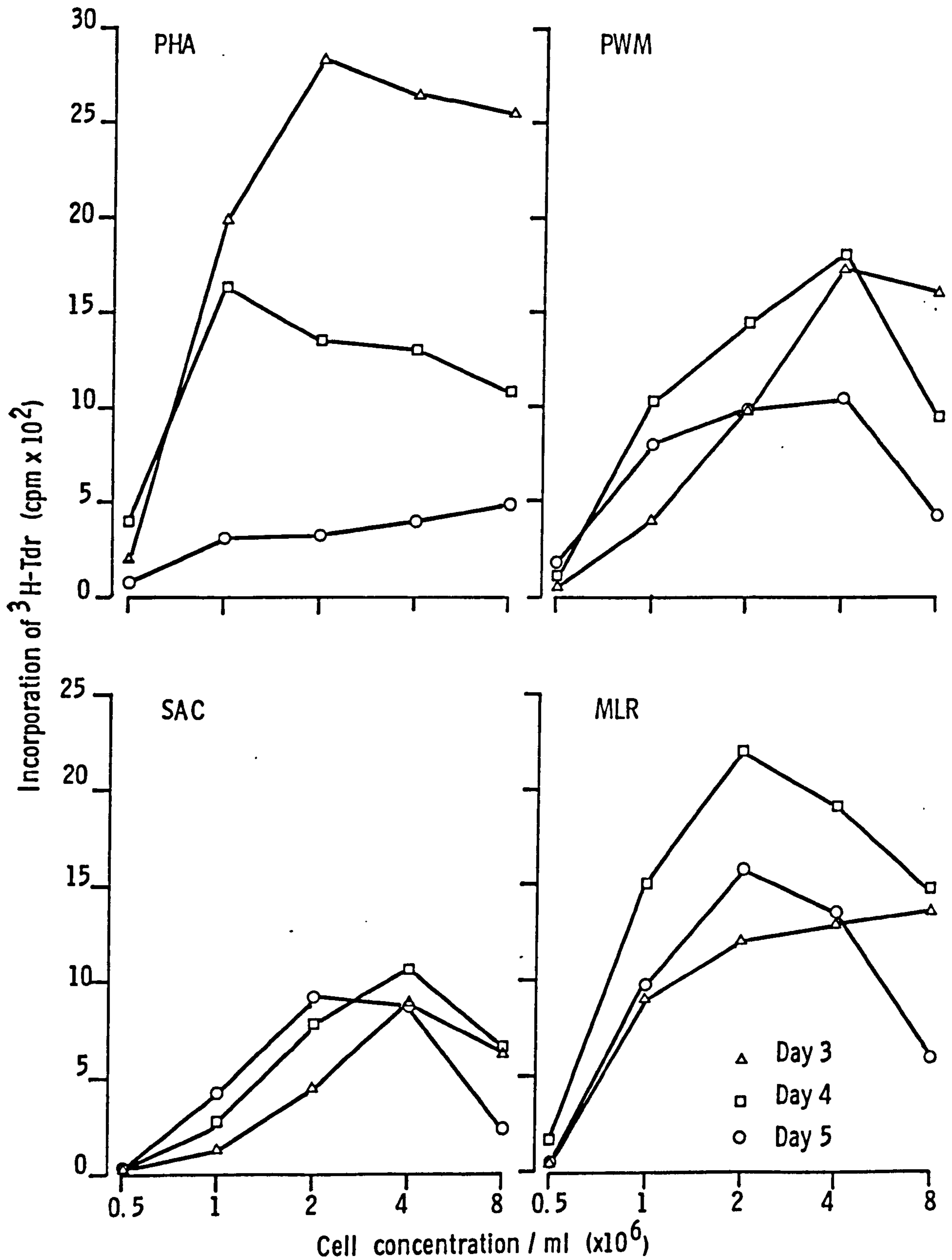


Figure 4 -14

Effect of culture period on proliferative responses of different concentrations of infant PBM cells.

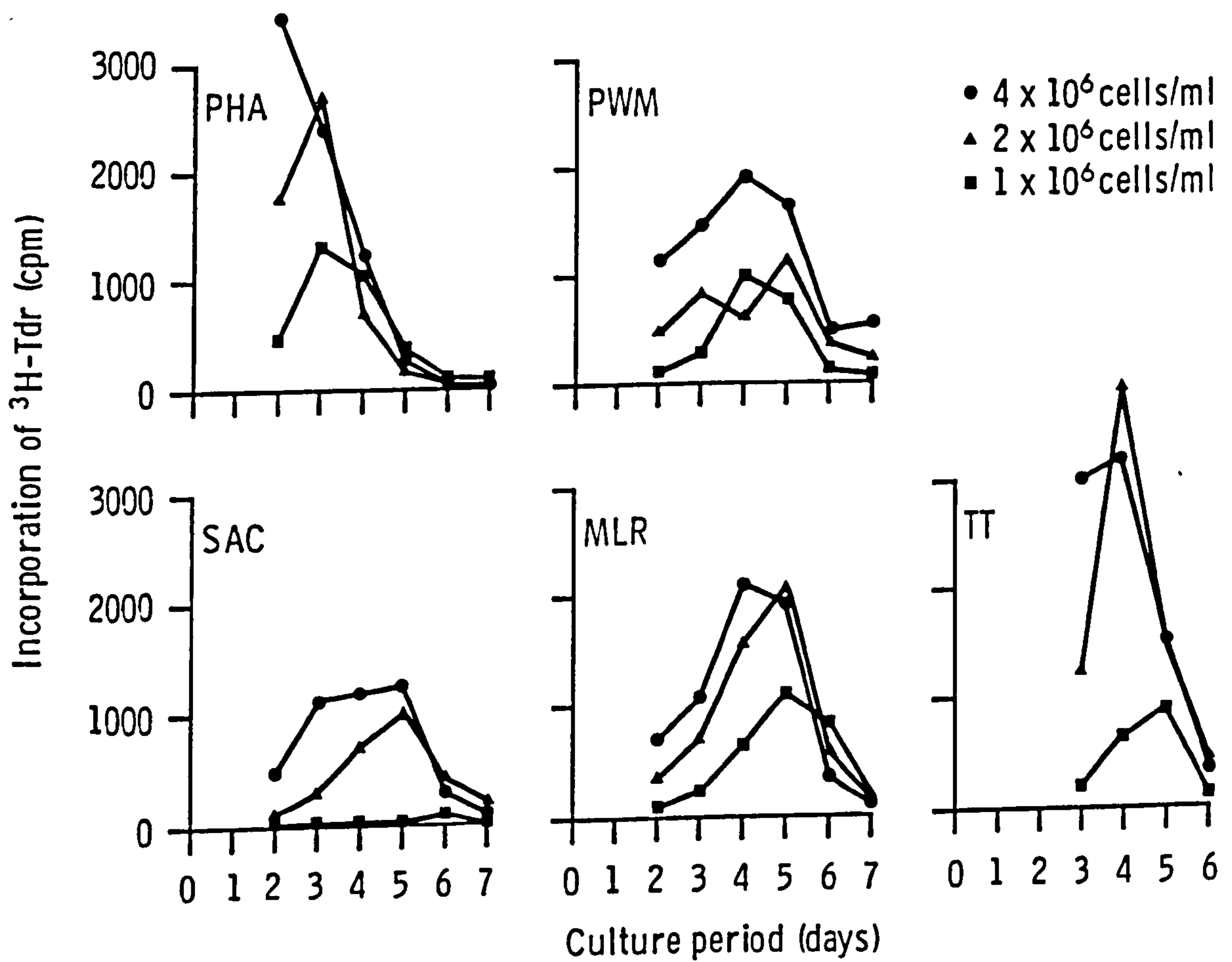


Figure 4 - 15

Comparison of proliferative responses of infant and adult PBM cells.

Cell concentration, 4×10^6 cells/ml.

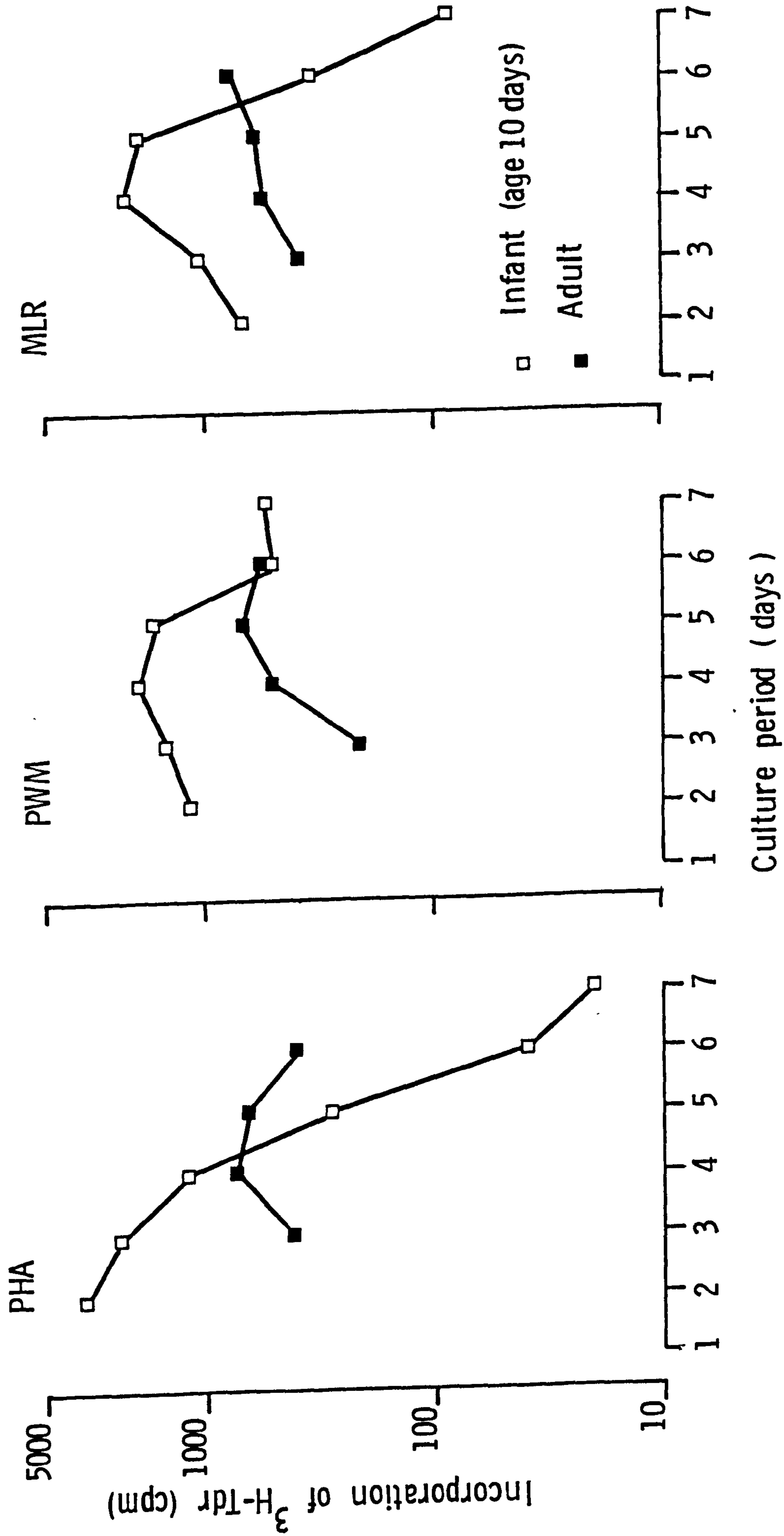


TABLE 4 - 1
 NUMBERS OF SAMPLES TESTED FOR PROLIFERATION ON EACH OCCASION

SPONTANEOUS PROLIFERATION		AGE																			
		6 DY			6 WK			3 M			6 M			9 M							
CELLS/ML ($\times 10^6$)		8	4	2	1	8	4	2	1	8	4	2	1	8	4	2	1	8	4	2	1
CULTURE DAY																					
BREAST -FED	3	6	12	13	14	7	13	13	13	7	15	15	15	5	15	15	15	1	13	13	13
	4	1	6	6	6	5	9	9	9	3	7	7	7	2	7	7	7	1	5	5	5
	5	4	12	12	14	7	13	13	13	7	15	15	15	5	15	15	15	1	13	13	13
BOTTLE -FED	3	7	11	12	12	8	13	13	13	2	14	15	15	4	13	13	13	1	15	15	15
	4	3	5	5	5	5	6	6	6	2	5	5	5	1	4	4	4	1	9	9	9
	5	6	11	12	12	8	13	13	13	2	14	15	15	4	13	13	13	1	15	15	15
MIXED LYMPHOCYTE REACTION																					
BREAST -FED	3	3	12	13	13	5	11	12	12	4	10	13	13	4	13	14	14	1	10	12	12
	4	1	5	5	5	4	7	7	7	2	7	7	7	2	7	7	7	1	3	3	3
	5	2	12	12	13	5	11	12	12	4	10	13	13	4	13	14	14	1	10	12	12
BOTTLE -FED	3	5	10	11	11	6	10	11	11	1	7	10	10	2	12	12	12	1	14	14	14
	4	2	4	4	4	4	6	6	6	1	5	5	5	2	4	5	5	0	8	8	8
	5	3	10	11	11	6	10	11	11	1	7	10	10	2	12	12	12	1	14	14	14

SECTION C - GENERAL OBSERVATIONS ON PROLIFERATION BY INFANT PBM CELLS**1) Comparison of spontaneous proliferation by infant and adult cell cultures.**

Spontaneous proliferation was low in all cultures (always less than 400cpm) compared with proliferative responses to mitogens (up to 7000cpm). However it was higher in infant cell cultures than adult cell cultures. For the cultures of adult cells, the geometric mean from 6 experiments on the peak harvest days 3 and 4 was 40cpm. For the cultures of infant cells, spontaneous proliferation resulted in geometric mean counts from 50 to 300cpm, depending on age and feeding group (i.e. up to 7-fold higher than for adult cells.).

2) Effect of differing cell concentrations.

As expected from the initial titrations, cell concentration had a significant effect on proliferation ($P < 0.0001$). The geometric means for the two feeding groups for each stimulant (averaged over days of culture and age) are shown in Fig 4 - 16. For spontaneous proliferation, the highest cell concentration (8×10^6 cells/ml) showed greatest proliferation. The responses to all five stimuli were maximal at 4×10^6 cells/ml. Proliferation was always lowest at 1×10^6 cells/ml.

3) Effect of harvesting on different days of culture.

Again, as indicated by the initial titration experiments, there was a significant difference between harvest days ($P < 0.0001$), which is illustrated for each stimulant in Fig 4 - 17. Maximal spontaneous proliferation occurred on day 4. Cells stimulated with PHA responded

most rapidly, with maximal responses on day 3 of culture. Responses to all other stimuli were maximal on days 3 to 4 at the higher cell concentrations and day 4 at 1×10^6 cells/ml. Responses for all cell concentrations were at their lowest on day 5. This maximal response was slightly earlier than had been indicated by the initial titrations (days 4 to 5, see Fig 4 - 14).

4) Effect of age on proliferation.

There was a significant effect of age on the proliferation in unstimulated cultures and for all stimulants used. This change with age was generally different for the two feeding groups and these results are therefore discussed in more detail below. Spontaneous proliferation was greatest at 6 weeks for the breast-fed infants and at 6 to 9 months for the bottle-fed group. Responses to PHA were highest for both groups at 6 weeks and 9 months ($P = 0.0018$). There was a slight decline in responses to PWM from 6 days to 3 months followed by an increase from 3 to 9 months. However this difference between ages for PWM did not quite reach the level of significance ($P = 0.070$). There was a significant effect of age on the proliferative responses to allogeneic lymphocytes ($P = 0.015$) with maximal responses at 6 weeks and 9 months of age. For MLR there was also an interaction of harvest day with age ($P < 0.0001$). This arose because although the maximal proliferation always occurred on the 4th day of culture, proliferation on day 3 was higher than day 5 for infants aged 6 days and 6 weeks but from 3 to 9 months, proliferation on these days was similar, indicating that the response was more rapid in the younger infants.

Figure 4 -16

Effect of cell concentration on proliferative responses of PBM cells from breast- and bottle-fed infants. Results are averaged over days of culture and age.

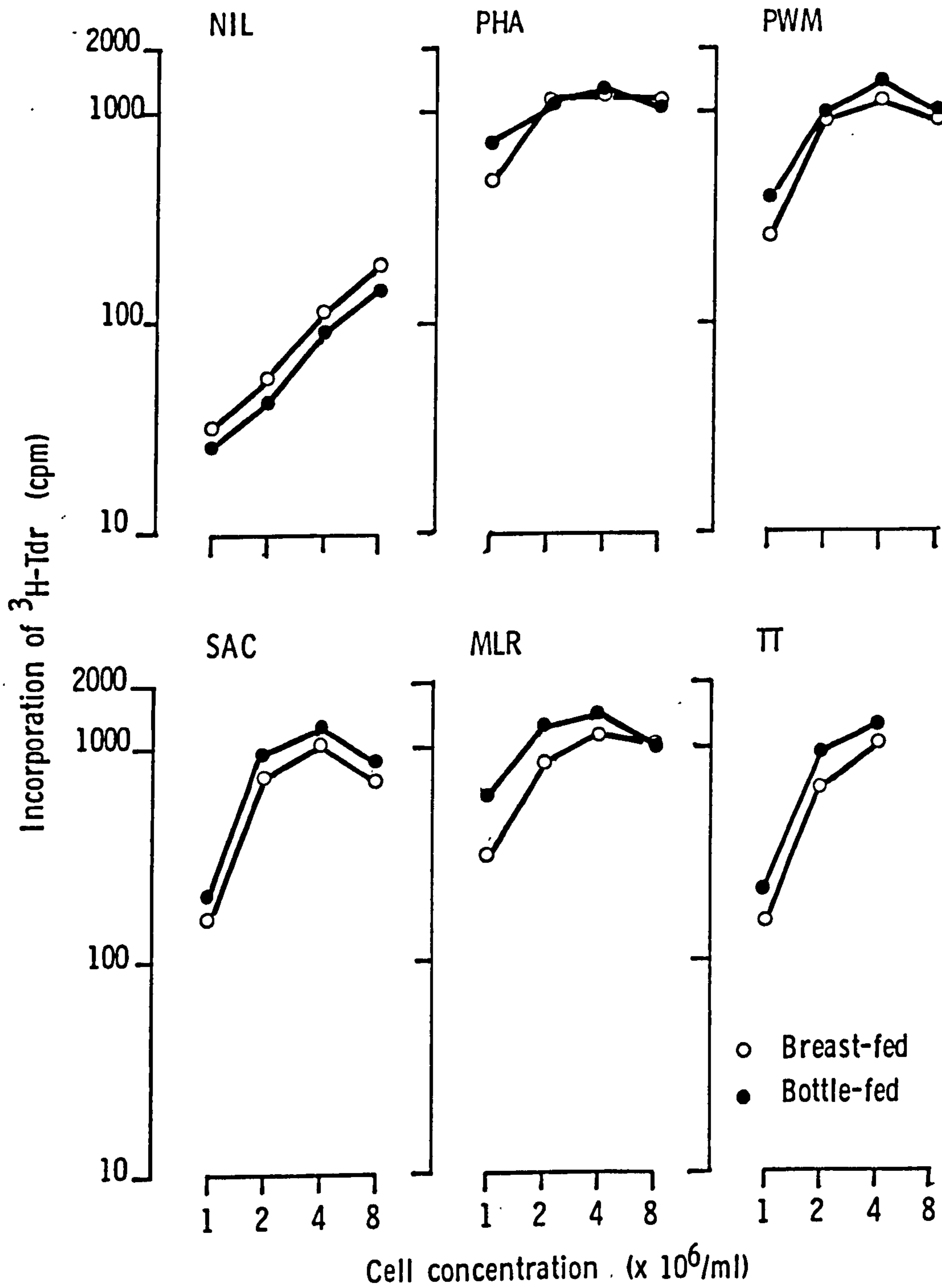
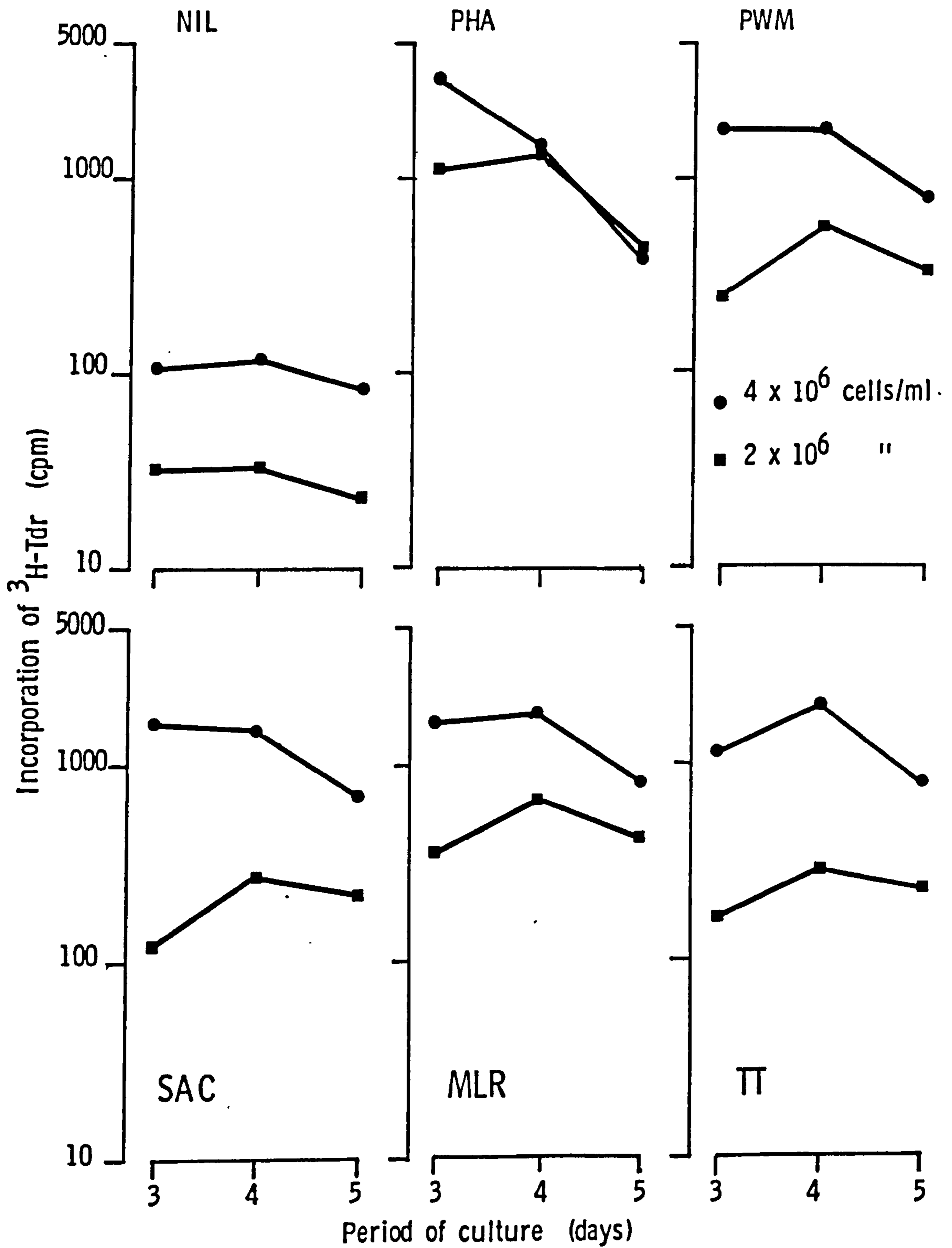


Figure 4 -17

Effect of period of culture on proliferative responses of PBM cells from infants at different cell concentrations. Results are averaged over feeding group and age.



SECTION D - DIFFERENCES IN PROLIFERATION BETWEEN FEEDING GROUPS

1) Spontaneous proliferation.

When the data were examined for differences between feeding groups, no significant differences were found between the overall group means (averaged over all cell concentrations, days of culture and ages; Br 65cpm, Bo 52cpm). Nor were there any interactions between feeding group and cell concentrations or harvest days. A significant interaction was noted however, between feeding group and age ($P = 0.012$), i.e. the change in spontaneous proliferation with age was different for the two groups. For each individual cell concentration, the significance of this interaction between feeding group and age was:- 4×10^6 , $P = 0.0013$; 2×10^6 , $P = 0.0073$; 1×10^6 , $P = 0.0091$. This difference between groups is summarised in Fig. 4 - 18 where the results are averaged over 4 cell concentrations and 3 harvest days. Each point therefore represents between 100-150 observations. At 6 days and 6 weeks, the spontaneous proliferation in breast-fed infants was more than double that in bottle-fed infants. By 3 months, the differences between the groups were minimal but by 6 and 9 months, the bottle-fed infants had a significantly higher rate of spontaneous proliferation.

Fig. 4 - 19 shows a more detailed investigation of these differences between the feeding groups for different days of culture and cell concentrations. The highest cell concentration (8×10^6) has been omitted from this figure as the number of samples studied at this level was low. For the remaining cell concentrations, points represent the average of duplicate samples from 12-15 infants per group (Table 4 - 1). It can be seen that the higher level of

spontaneous proliferation in breast-fed infants at 6 days and 6 weeks of age, occurred at all cell concentrations and on all days of culture. The differences between groups were greatest at the highest cell concentration (4×10^6) and on the maximal harvest days 3 and 4.

2) Responses to mitogens.

i) PHA

There were no significant differences between the overall means for the two feeding groups, nor were there any interactions between feeding group and day of culture. There was a significant difference between responses of the two feeding groups at different cell concentrations ($P = 0.039$) with lower responses (averaged over all days of culture) in the breast-fed group at 1×10^6 cells/ml (see Fig. 4 - 16).

A test for interaction of age with feeding group by analysis of variance (found to be highly significant for spontaneous proliferation - see above) did not quite reach the level of significance ($P = 0.058$). However, when tested at individual ages (using a Bonferroni t-test) there was a significantly greater response in the bottle-fed group than the breast-fed group at 3 and 9 months ($P < 0.05$) and 6 months ($P < 0.01$). These results are illustrated in Fig 4 - 20, averaged over all cell concentrations and days of culture. When the interaction of age and feeding group was examined in more detail (Fig. 4 - 21) it could be seen that at the time of maximal proliferation (day 3) there was a significant interaction between group and age ($P = 0.007$) and this is illustrated (averaged over all cell concentrations) in Fig. 4 - 22. At 6 days and 6 weeks of age, the proliferative responses were higher in breast-fed infants. By 3 months of age, the

responses were higher in the bottle-fed group and this greater response was maximal at 6 and 9 months.

ii) Responses to PWM.

The data were analysed for interactions of feeding group with age, cell concentration and days of culture. None of these overall interactions was significant. A detailed analysis of the data is illustrated in Fig. 4 - 23. Responses were similar between the two feeding groups at 6 days and 6 weeks of age at all cell concentrations and on all days of culture. However, from 3 to 9 months, proliferative responses were greater in the bottle-fed group and this difference was significant (Bonferroni t-test, $P < 0.05$). The difference between groups was most apparent at the time of maximal proliferation on day 4 of culture and at the lowest cell concentration (Fig. 4 - 24). Although the interaction of group with age was again not significant at this cell concentration, there was a significantly greater response in bottle-fed infants at 3, 6 and 9 months (Bonferroni t-test $P < 0.05$). The overall group mean at 4×10^6 cells/ml (averaged over all days of culture and ages) was also significantly higher for the bottle-fed group (Br = 1152cpm, Bo = 1399cpm; $P = 0.023$).

iii) Responses to SAC.

The pattern of proliferative responses to SAC were very similar to PWM responses (Fig. 4 - 25 compared with Fig. 4 - 23). The responses were similar in both feeding groups at 6 days and 6 weeks of age but from 3 to 9 months the responses were again greater in the bottle-fed group. This difference is illustrated averaged over all cell concentrations and days of culture in Fig. 4 - 26a. Although the

overall interaction of group with age (analysis of variance) was not significant, there was a significant difference between the groups at 6 months (Bonferroni t-test, $P < 0.01$) with the bottle-fed infants showing a greater proliferative response to SAC. The interaction of group with age was however, significant for the peak cell concentration (4×10^6 cells/ml, $P = 0.014$) but not the peak day of culture (day 4, Fig. 4 - 26b).

3) Proliferative responses to allogeneic lymphocytes.

There was a significant difference between the overall group means (averaged over all ages, cell concentrations and harvest days) ($P = 0.0040$) with the geometric means for the bottle-fed group being higher (Br = 690cpm; Bo = 1032cpm). There was also a significant interaction between age and feeding group ($P = 0.029$) which is illustrated in Fig. 4 - 27a. The responses (averaged over all cell concentrations and days of culture) were similar between the two groups at 6 days and 6 weeks, but from 3 to 9 months the responses were substantially lower in the breast-fed group. When the data were analysed in more detail (Fig. 4 - 28) it could be seen that this difference between groups occurred on all days of culture and at all cell concentrations, although the difference was most marked at the lowest cell concentration (1×10^6 cells/ml, $P = 0.024$). Also, at 6 days of age, the proliferative responses of the breast-fed infants were slightly greater than the bottle-fed infants on days 3 and 4 of culture (see Figs. 4 - 27b and 29), whereas the bottle-fed group showed higher proliferation on day 5. This indicates that although there was no difference in the overall response at this age (Fig. 4 - 27a), the responses of PBM cells from breast-fed infants occurred

earlier in the culture period.

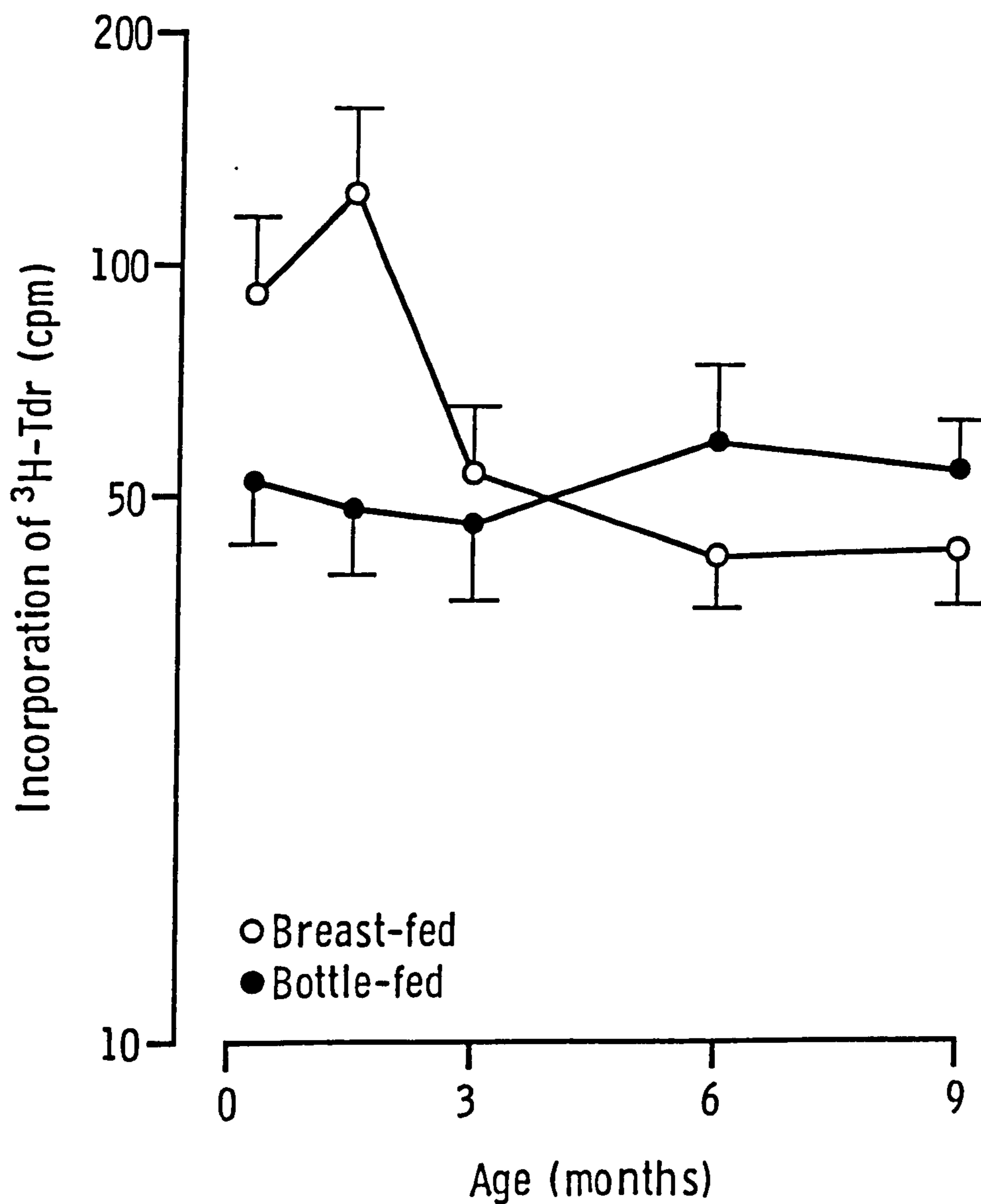
4) Proliferative responses to tetanus toxoid.

Stimulation of infant PBM cells with tetanus toxoid (TT) was not included at the beginning of the study and was only set up when all other tests had been done on the cells. For this reason, the numbers of infants in each group were much smaller than for the other stimuli, as is shown in the following table:-

		AGE				
		6days	6weeks	3mths	6mths	9mths
Breast-fed	n =	2	2	2	11	10
Bottle-fed	n =	3	5	3	9	12

Because of these low numbers, no significant interactions were detected by the analysis of variance. However, when the average results (for all days of culture and cell concentrations) were examined for differences between ages (Fig. 4 - 29) a similar pattern was seen as for the other stimuli, with a greater response of breast-fed infants at 6 days of age (Bonferroni t-test, $P < 0.05$), maximal proliferation in both groups at 6 weeks and lower responses in breast-fed infants from 3 to 9 months. This was similar for all days of culture and cell concentrations (Fig. 4 - 30).

Figure 4 -18

Spontaneous proliferation in PBM cells
from breast and bottle-fed infants

Geometric means ($\pm 95\%$ C.I.) averaged over all cell concentrations, days of culture and age.

Figure 4 -19

Spontaneous proliferation by PEM cells from breast- and bottle-fed infants at three cell concentrations and days of culture.

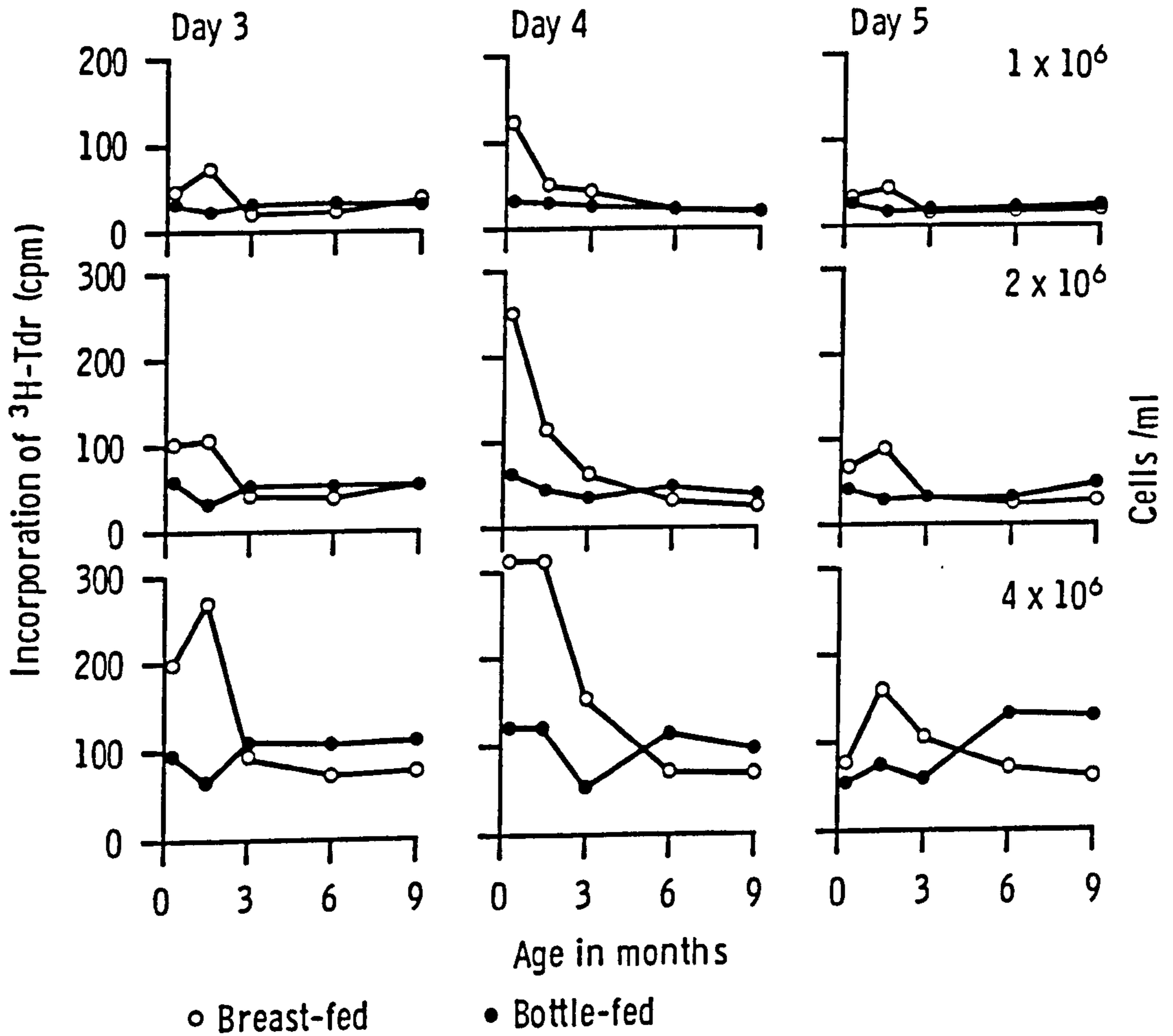


Figure 4 - 20

Proliferative responses of PBM cells from breast- and bottle-fed infants to PHA ($1\mu\text{g}/\text{ml}$). Geometric means ($\pm 95\%$ C.I.) of four cell concentrations and three days of culture.

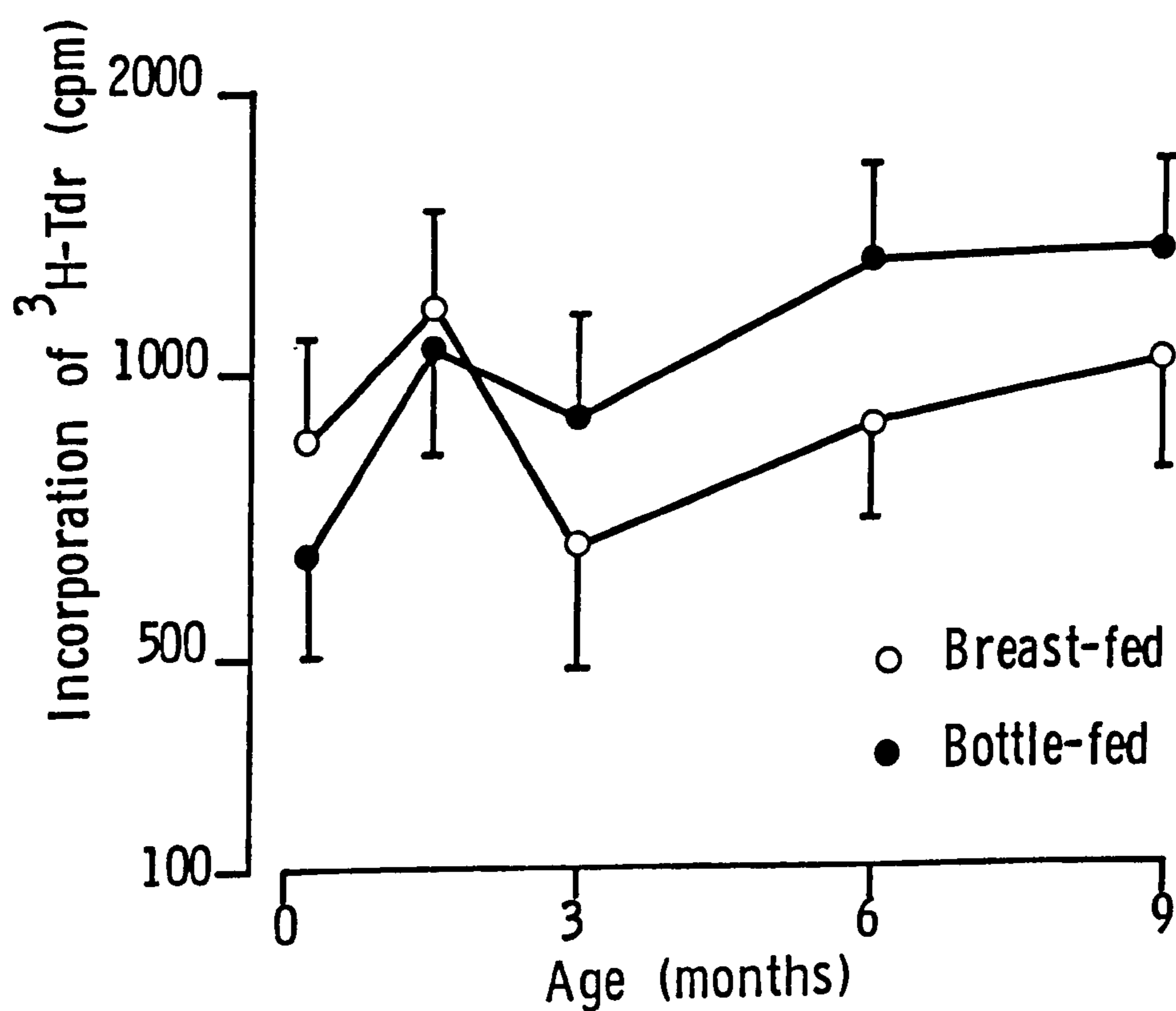


Figure 4 - 21

Proliferative responses of PBM cells from breast- and bottle-fed infants to PHA ($1\mu\text{g/ml}$). Results are illustrated at each cell concentration and day of culture.

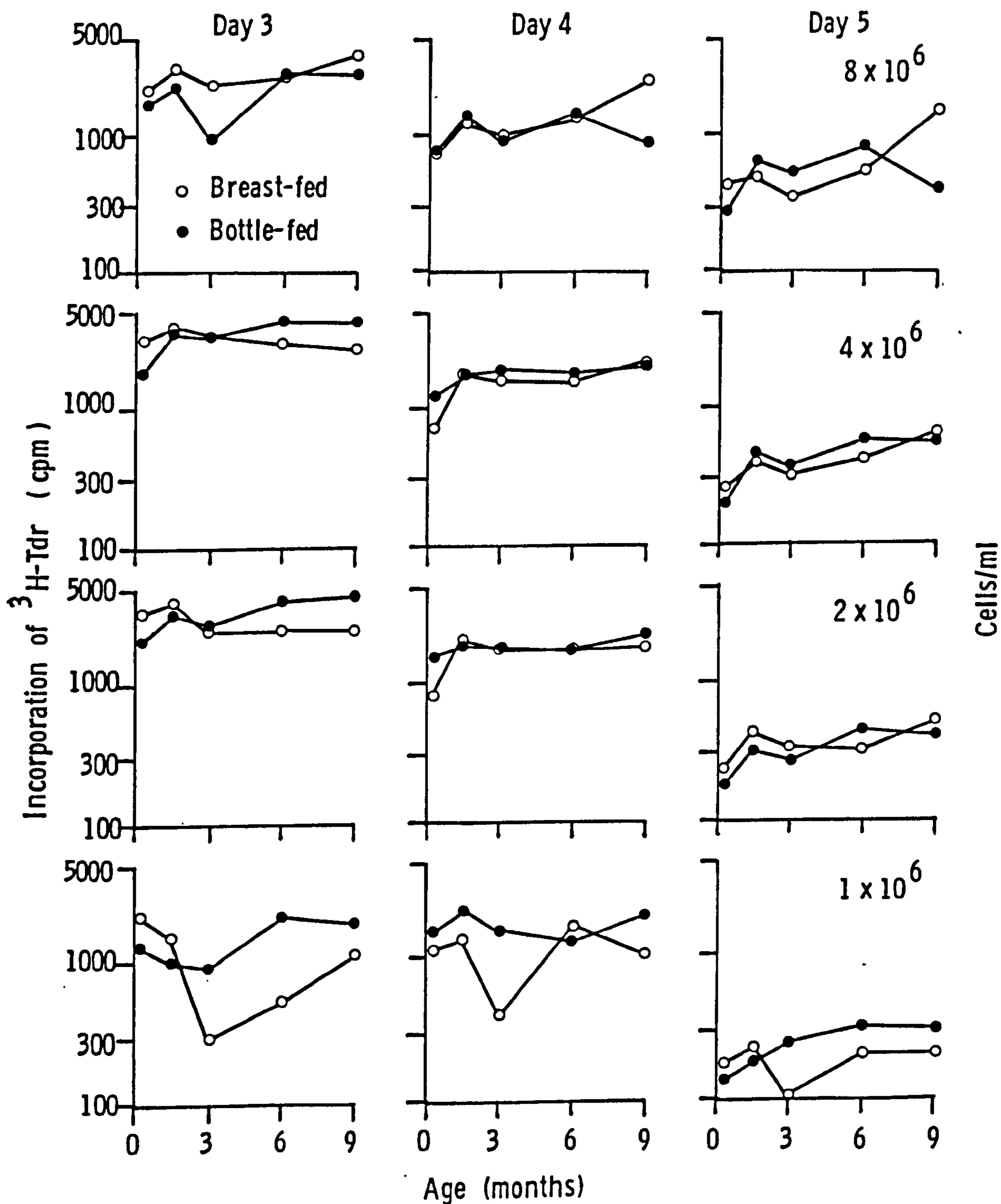


Figure 4 - 22

Proliferative responses of PBM cells from breast- and bottle-fed infants to PHA ($1\mu\text{g}/\text{ml}$) on maximal day of culture. Geometric means ($\pm 95\%$ C.I.) over four cell concentrations.

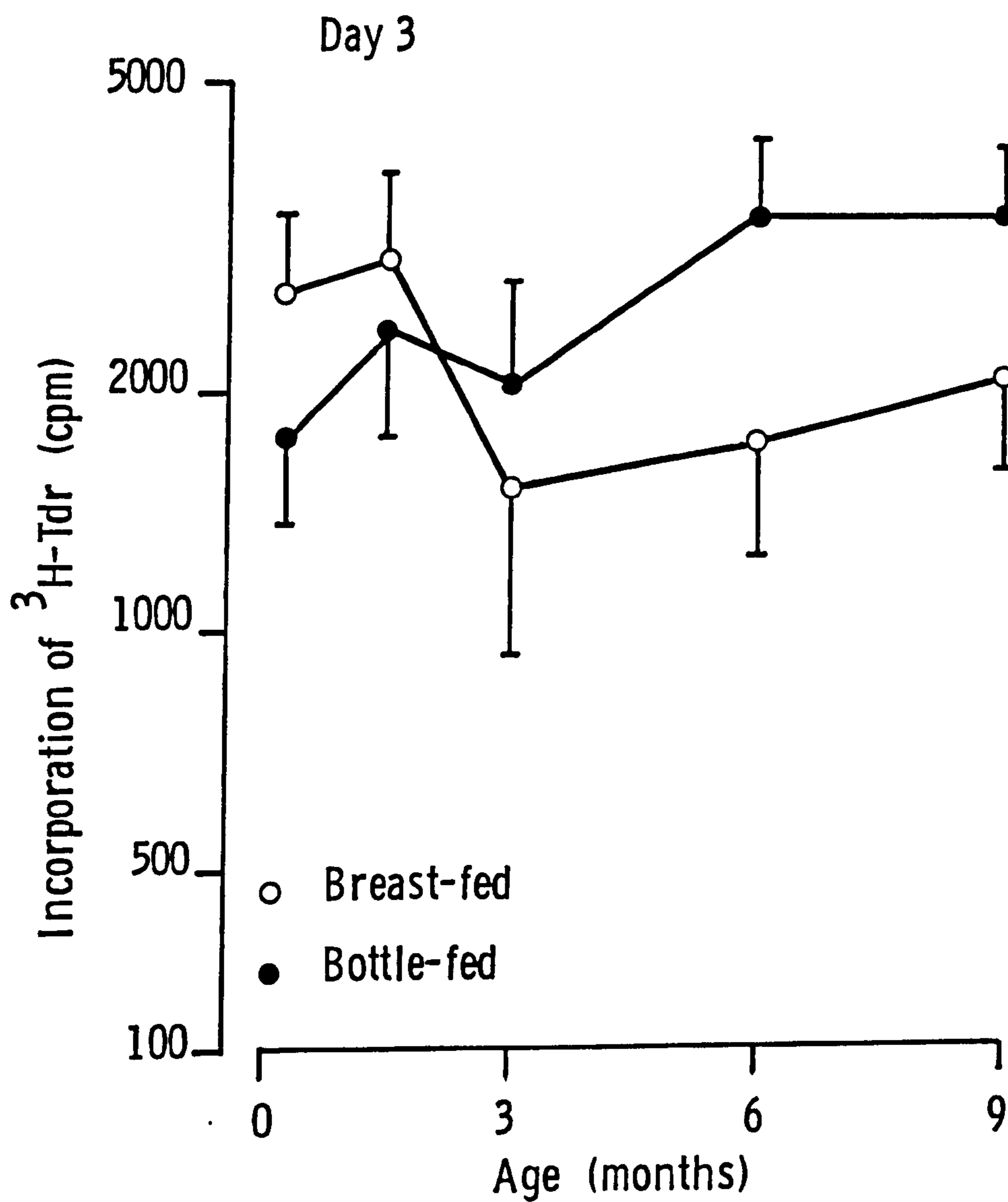


Figure 4 - 23

Proliferative responses of PBM cells from breast- and bottle-fed infants to PWM ($1\mu\text{g/ml}$), illustrated at four cell concentrations and three days of culture.

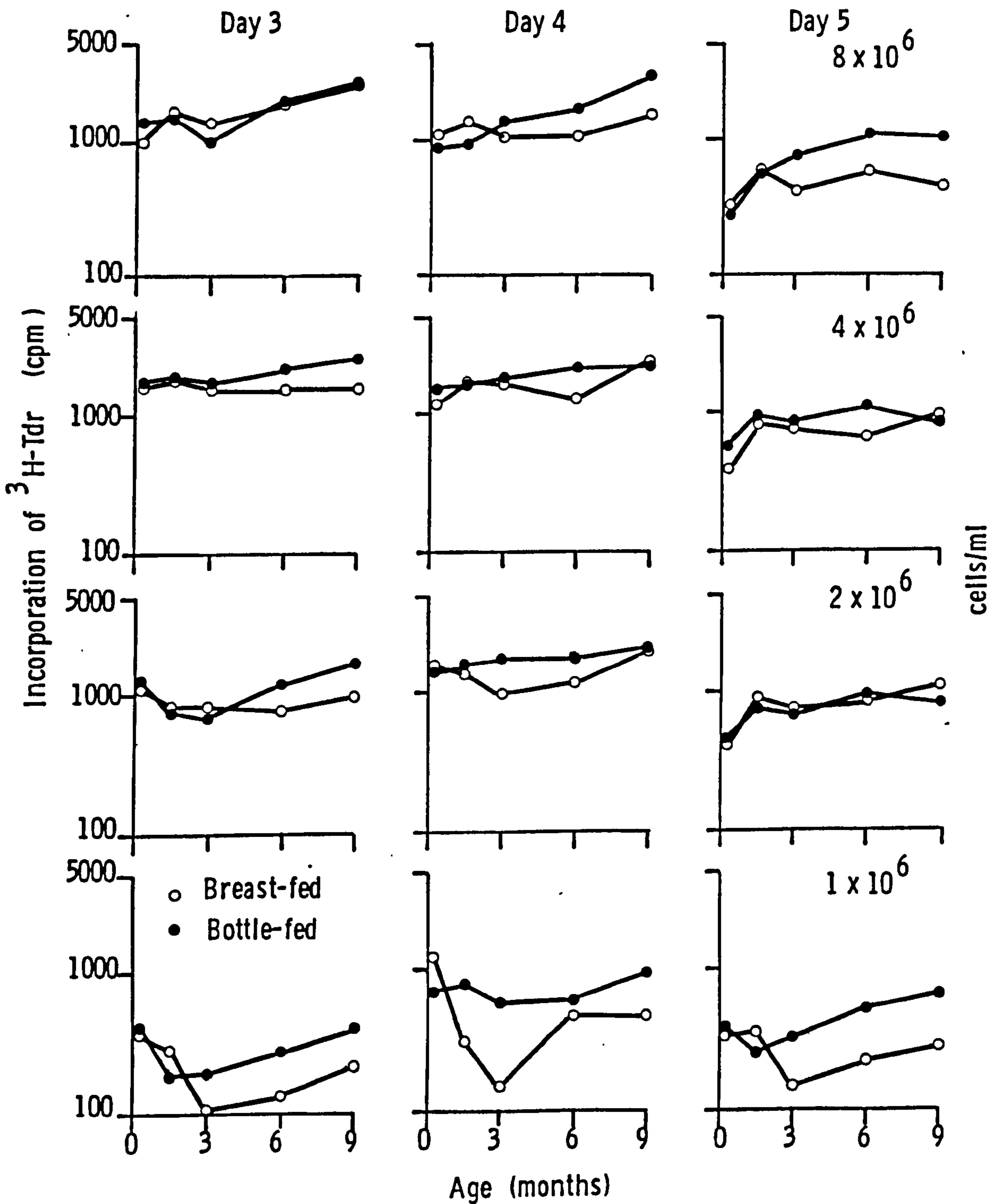


Figure 4 - 24. Proliferative responses of infant PBM cells to PWM. Geometric means ($\pm 95\%$ C.I.) over all cell concentrations* and days of culture.*

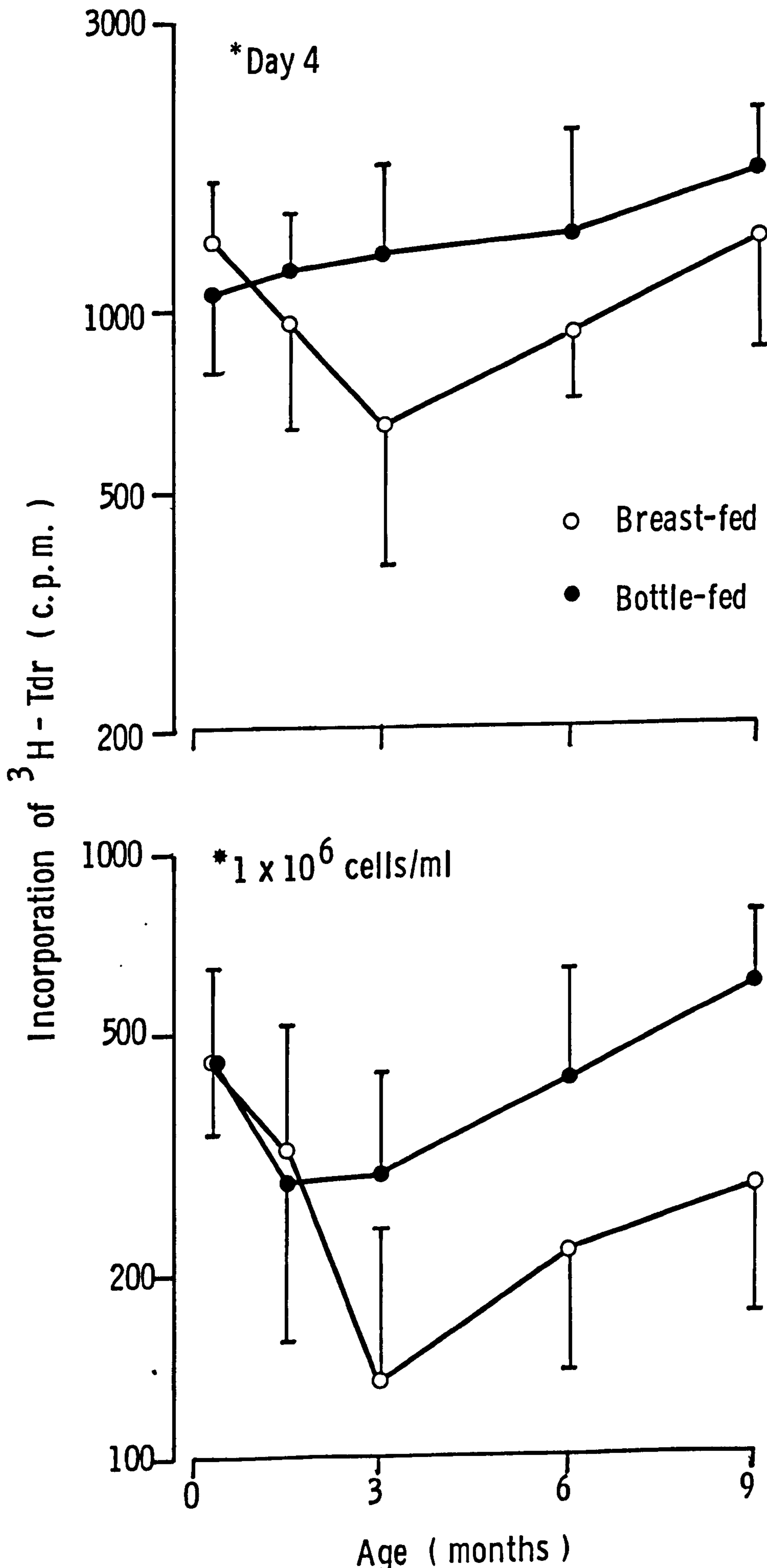


Figure 4 - 25

Proliferative responses of PBM cells from breast- and bottle-fed infants to SAC (1/2000), illustrated for each cell concentration and day of culture.

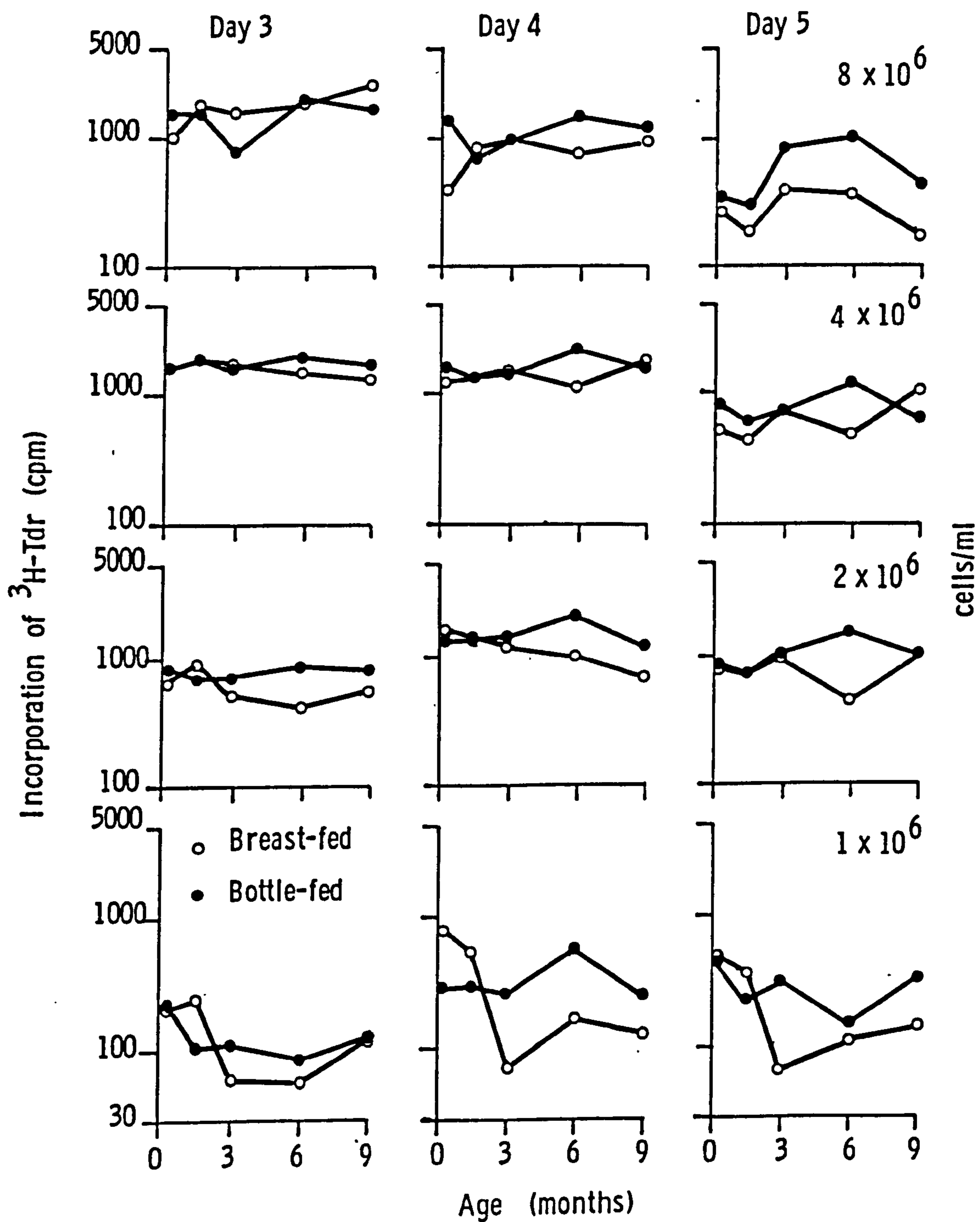


Figure 4 - 26. Proliferative responses of infant PBM cell to SAC. Geometric means over all days of culture (a), and for maximal day 4 (b)

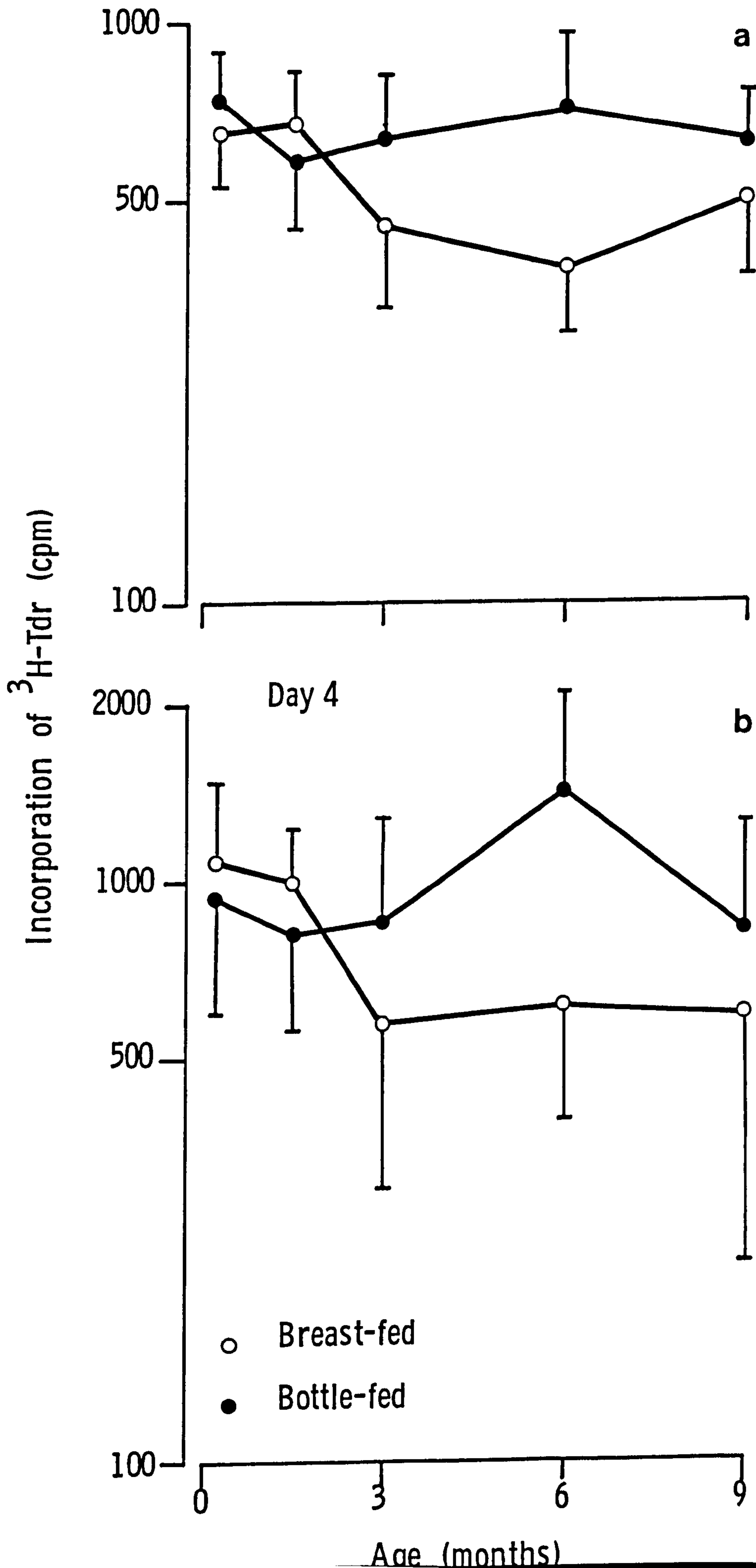


Figure 4 - 27. Proliferative responses of infant PBM cells to allogeneic lymphocytes. Averaged over all days of culture (a), and for day 4 (b).

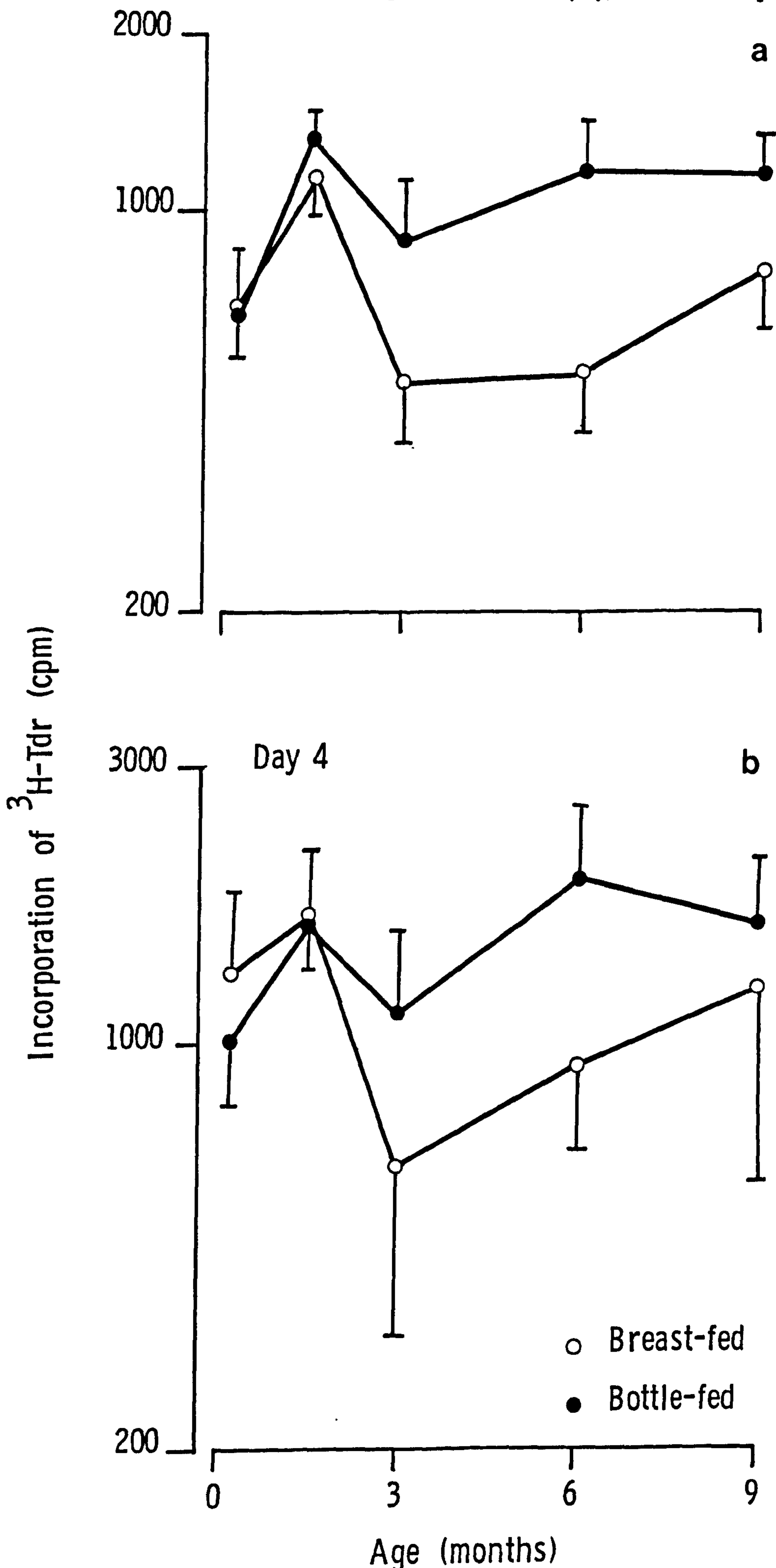


Figure 4 - 28

Proliferative responses of PBM cells from breast- and bottle-fed infants to allogeneic lymphocytes (Cla-4 B cell line). Results are illustrated for each cell concentration and day of culture.

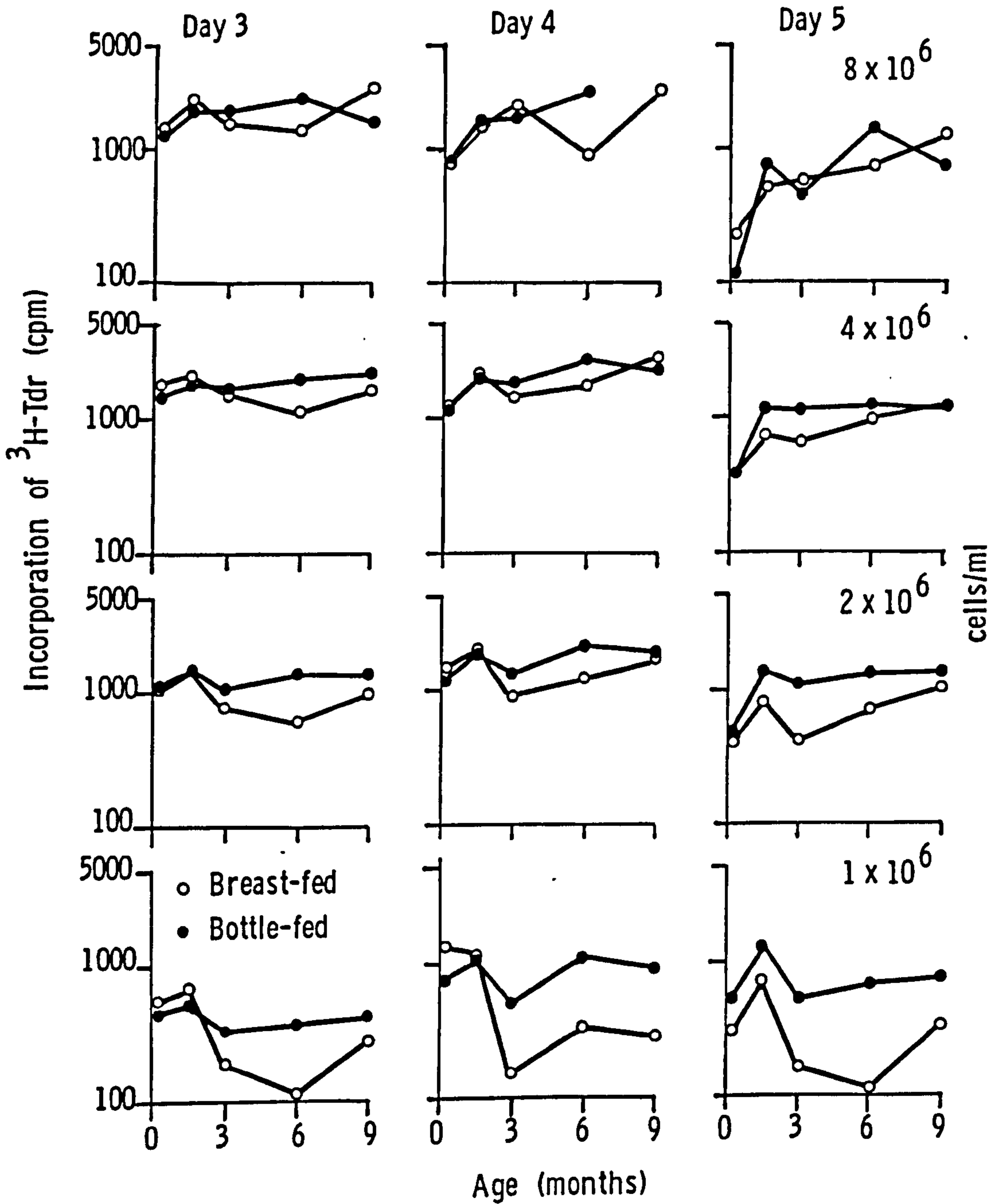


Figure 4 - 29

Proliferative responses of PBM cells from breast- and bottle-fed infants to tetanus toxoid. Geometric means ($\pm 95\%$ C.I.) over all cell concentration and days of culture.

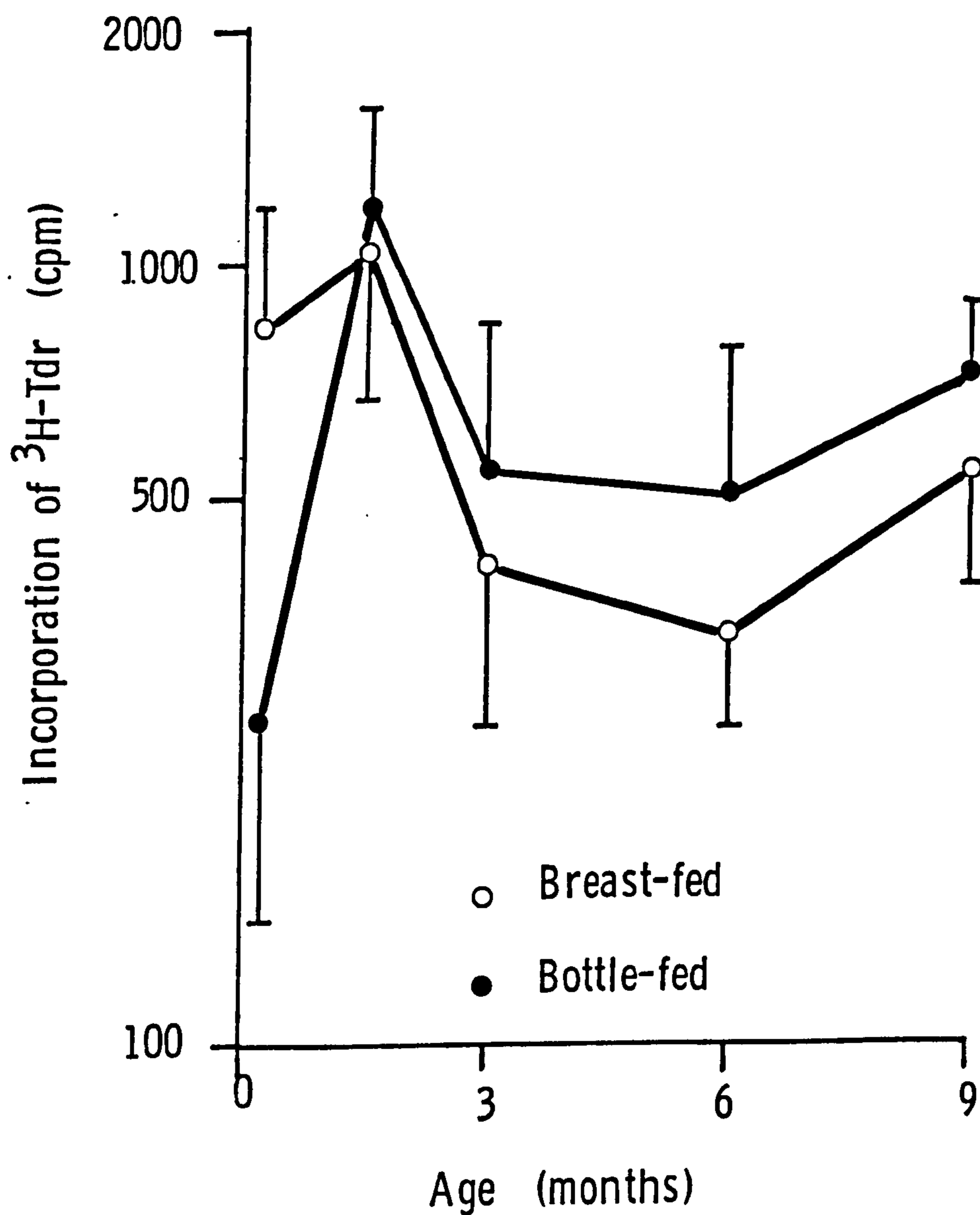
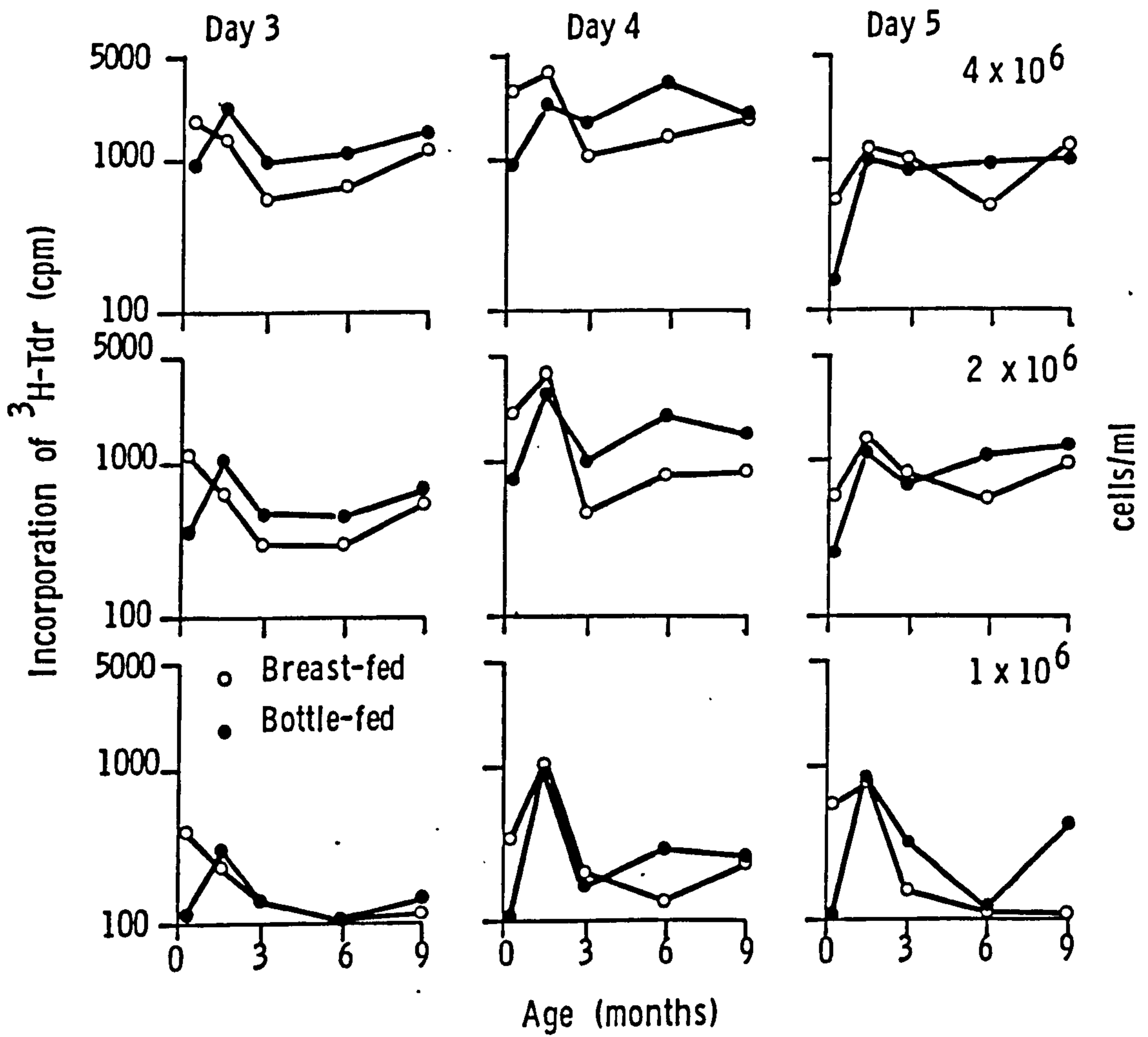


Figure 4 - 30

Proliferative responses of PBM cells from breast- and bottle-fed infants to tetanus toxoid. Results are illustrated for each cell concentration and culture day.



SECTION E - DISCUSSION

1) General responses by infant and adult cells.

This study of proliferation by infant PBM cells, using Iscove's serum-free medium (Iscove and Melchers, 1978) has shown that although the spontaneous proliferation is considerably lower using this medium than reported in other studies using serum-containing media, the substantially greater responses of infant cells than adult cells remain. The average spontaneous proliferation by infant PBM cells was 7-fold greater than that by adult cells. Spontaneous proliferation by infant cells increased steadily with increasing cell concentration and was maximal on day 4 of culture.

As outlined in Chapter 1, previous workers have shown that cord blood lymphocytes (CBL) and infant PBL have a higher rate of proliferation in 'unstimulated' cultures than adult PBL (Stites *et al.*, 1972; Alford, Cartwright and Sell, 1976; Ben-Zwi *et al.*, 1977) which is probably due to higher proportions of infant PBL cells proliferating (Stiehm, Winter and Bryson, 1979). This increased proliferation has been attributed to partial activation of the cells *in vivo* (Stites *et al.*, 1972; Weber, Santesson and Skoog, 1973), possibly due to foetal cellular responses to materno-foetal incompatibilities (Faulk *et al.*, 1973). However these studies have all used media containing serum, which is known to have mitogenic properties and therefore, in contrast to this current study, this 'unstimulated' proliferation could not confidently be called spontaneous.

In this present study, responses of infant PBL to mitogens, allogeneic lymphocytes and tetanus toxoid have also been investigated. Using a single dose of mitogen but multiple cell concentrations and days of culture, maximal proliferative responses of infant cells were greater and occurred earlier than those of adult cells in response to all mitogens tested (PHA, PWM, SAC). Maximal responses by infant PBM occurred on day 3 for PHA driven cells and day 4 for PWM and SAC stimulated cells, although lower cell concentrations tended to reach maximal proliferation slightly later in the culture period. This was 1 to 2 days earlier than the (lower) maximal responses by adult cells. Unlike spontaneous proliferation, responses to mitogens were maximal at 4×10^6 cells/ml and further increases in cell concentration resulted in lower responses.

For the mixed lymphocyte reaction, the optimal stimulating dose of cells was similar for adult and infant responding cells, but responses of infant cells were more vigorous than adult cells. As with the response to mitogens, proliferation of infant PBM in response to allogeneic lymphocytes was more rapid and maximal responses were greater than adult cells. Although a direct comparison was not made between infant and adult responses to TT, all infants gave good proliferative responses to this antigen, even prior to immunisation.

Previous studies on CBL and infant PBL have given conflicting results. Some workers have indicated that these cells respond more vigorously than adult cells to T cell mitogens such as PHA and Concanavalin A (Eife *et al.*, 1974; Alford, Cartwright and Sell 1976; Ben-Zwi *et al.*, 1977; Gill *et al.*, 1979) and this response occurs earlier after stimulation (Weber, Santesson and Skoog, 1973; Yoffey

et al., 1978). However, other workers have reported similar proliferative responses by infant and adult cells (Andersen *et al.*, 1973) or lower responses by infant cells (Jones, 1968; Pittard, Miller and Sorensen, 1984). This discrepancy has been attributed to the variability of responses by infant and adult PBL when different mitogen doses, cell concentrations and days of culture are used (Stites *et al.*, 1972; Wara and Barrett, 1979). It now seems clear that this variability has produced misleading results because only single points were assessed.

Proliferative responses to mitogens such as PWM and SAC which stimulate B cells, have also been reported as higher in normal newborns than adults (Wu *et al.*, 1976; Ruuskanen *et al.*, 1980). However in another study, the same group of workers reported similar responses between neonates and adults to these mitogens using a single mitogen dose, cell concentration and day of culture (Pittard, Miller and Sorensen, 1984). Unander, Hammarstrom and Smith (1983) found proliferative responses to PWM and SAC were lower in infant cells than adult cells. This discrepancy may again be due to the fact that the optimal stimulating dose of these mitogens is higher for adult cells than for infant cells (Stites *et al.*, 1972; Ben-Zwi *et al.*, 1977).

Proliferative responses of infant PBL to allogeneic lymphocytes has been reported as comparable to adult cells (Stiehm, Winter and Bryson, 1979). Responses of CBL or infant PBL to antigens such as tetanus toxoid have been variably reported as absent in unimmunised infants (Leiken and Oppenheim, 1970; Alford, Cartwright and Sell, 1976) to lower than adults (Gill *et al.*, 1979). The observation that all infants in this present study gave good proliferative responses to

tetanus toxoid, even before they had been immunised with this antigen, may indicate that the TT preparation used had some mitogenic properties. This will be discussed further in Chapter 5.

2) Differences between breast- and bottle-fed infants.

Significant differences were noted in the responses of breast- and bottle-fed infants for spontaneous proliferation and proliferative responses to all stimuli. These differences were associated with age and fell into two main categories; those occurring in newborn infants (6 days and 6 weeks of age) and those occurring in older infants (3 to 9 months).

Newborn breast-fed infants showed significantly greater rates of spontaneous proliferation than bottle-fed infants and this occurred at all cell concentrations and on all days of culture. Spontaneously proliferating cells have been characterised as non-T/non-B cells (as determined by inability to rosette sheep red blood cells or possess surface Ig) and since the proportions of T cells are increased after spontaneous proliferation, these proliferating cells may be a population of T cell precursors (Treves, Barak and Fuks, 1980). The greater proliferation in infant cells than adult cells has been attributed to partial activation of these cells *in vivo* (see above). It is possible that this substantially increased spontaneous proliferation in the breast-fed infants may be due to further stimulation *in vivo* by soluble factors, present in human milk and capable of stimulating lymphocytes *in vitro*, which have been absorbed by the breast-fed neonate. A number of such factors have been described (Emodi and Just, 1974; Klagsburn, 1978; Pittard and Bill, 1979a and b; Lucas and Mitchell, 1980; Keller *et al.*, 1981; Blau *et*

al., 1983; Klagsburn and Shing, 1984). Cells from breast-fed infants were also more responsive to PHA at this time, and responses to allogeneic lymphocytes occurred slightly earlier in this group. Both these stimuli have been shown to affect T cells rather than B cells (Chapter 1), and this suggests that T cells may therefore also be partially activated *in vivo* by these factors in milk. Proliferative responses to tetanus toxoid were also significantly greater at 6 days in breast-fed infants. Since these infants were not vaccinated, it is unlikely that this was an antigen specific response and could therefore be due to a mitogenic effect of TT (as mentioned above) which could be stimulating T or B cells. Proliferative responses to the mitogens known to stimulate B cells (PWM and SAC) were similar (at all cell concentrations and days of culture) in breast- and bottle-fed infants during this early neonatal period, suggesting that B cell responses were comparable in the two feeding groups at this time.

By 3 to 6 months of age, spontaneous proliferation and proliferative responses to all stimuli (PHA, PWM, SAC, MLR and TT) were significantly greater in the bottle-fed group. This difference was apparent at all cell concentrations and on all days of culture but tended to be greatest on the maximal day of culture. This suggested that all classes of lymphocytes (non-T/non-B, T and B cells) were receiving greater stimulation *in vivo* in the bottle-fed infants. This could be the result of a combination of effects. First, by this age there may be a reduced intake of lymphokines and growth factors from milk in the breast-fed infants. Beardmore, Lewis-Jones and Richards, (1983) and Read *et al.*, (1984) have shown reduced levels of epidermal growth factor in mature milk while other components in milk such as antimicrobial proteins still remain at a fairly high level (Carlsson

et al., 1976; Ogra, Weintraub and Ogra, 1978). Second, there is a continual uptake of macromolecules from the gut in both groups of infants, but the lack of protective antibodies from human milk may result in an increased uptake of potentially antigenic molecules in the bottle-fed group, and this may result in a general increase in the stimulation of the systemic immune system. This will be discussed in more detail in Chapters 6 and 8 .

SUMMARY

Spontaneous proliferation and proliferative responses of PBM cells to a number of stimuli have been studied in breast- and bottle-fed infants and compared with responses of adult cells. Spontaneous proliferation and responses to T and B cell mitogens, allogeneic lymphocytes and tetanus toxoid occurred earlier in infant cells than adult cells, and the maximal responses were greater. When breast- and bottle-fed infants were compared, spontaneous proliferation and responses to the T cell mitogen PHA and the antigen tetanus toxoid were significantly greater in the breast-fed group at 6 days and 6 weeks of age. One possible explanation for this greater proliferation in breast-fed infants is that it may be attributable to absorption by breast-fed infants of soluble factors (lymphokines) from human milk. Responses to PWM and SAC were similar at this time, suggesting that T or non T/non B cells rather than B cells were being affected by these factors. In contrast, from 3 to 9 months of age, responses to all stimuli were significantly greater in the bottle-fed group. This indicates that during this period, all cell types were more responsive in this group. It is suggested that this is due to a higher level of antigenic stimulation in the bottle-fed infants.

CHAPTER 5

B CELL DIFFERENTIATION AND IMMUNOGLOBULIN PRODUCTION *IN VITRO*

In the previous chapter, the proliferative responses of infant mononuclear cells to various stimuli have been examined. After stimulation with the appropriate mitogen or antigen, a proportion of B cells will not only proliferate but will also differentiate and become immunoglobulin or specific antibody secreting cells (Fauci and Pratt, 1976). The culture conditions required for specific antibody production are more critical than those required for proliferative responses; culture medium, cell densities, monocyte numbers and T/B ratios all have a profound effect on B cell differentiation (Rich and Pierce, 1973; Fauci and Pratt, 1976; Waldmann and Broder, 1982). Controlling T/B ratios and monocyte numbers *in vitro* requires cell separation procedures, techniques which need larger numbers of cells than those available from newborn infants.

This Chapter is therefore divided into two sections. The first section will describe experiments conducted *in vitro* using peripheral blood mononuclear (PBM) cells which were separated from heparinised infant blood on a Ficoll- Paque gradient and cultured without any attempts to adjust the proportions of T cells, B cells or monocytes (called unseparated PBM). These cultures therefore contained suboptimal proportions of these cells for *in vitro* immunoglobulin and antibody production. The second section will describe experiments, mainly using cells from adult blood, in an attempt to develop techniques to enhance the culture conditions and cell ratios sufficiently for specific antibody production *in vitro*, using smaller numbers of cells than were needed for the currently available

techniques.

SECTION A - IMMUNOGLOBULIN PRODUCTION BY UNSEPARATED
INFANT MONONUCLEAR CELLS

1) Introduction.

Mitogens such as pokeweed have been extensively used to stimulate B cells to secrete immunoglobulin (Cooper, Lawton and Bockman, 1971; Fauci and Pratt, 1976; Waldmann and Broder, 1982.). Unseparated peripheral blood mononuclear cells from adults, grown in media containing serum, show an increase in immunoglobulin secretion when stimulated with PWM, although optimal ratios of T/B cells for Ig production *in vitro* are lower than those found in peripheral blood (De la Concha *et al.*, 1977; Janossy *et al.*, 1977). Specific antigen stimulates a much smaller proportion of human PBM and the quantity of immunoglobulin produced is therefore much less than in mitogen driven systems. Antigen stimulation of cells grown in FCS-containing media, however, gives misleading results, as batches of FCS which support B cell growth are themselves mitogenic (Brenner, 1981). In order therefore, to study the effect of antigen alone, initial experiments were conducted using the serum-free medium of Iscove and Melchers (Flow Laboratories, see Chapter 2) which has been successfully used for LPS-induced plaque formation in murine studies (Iscove and Melchers, 1978).

2) Spontaneous immunoglobulin production by unstimulated infant PBM cells

Cultures were set up as described for experiments on proliferation. After 8 days of incubation, the Terasaki culture plates were stored at -70°C . Supernatants from pooled duplicate wells were diluted 1/3 initially, followed by serial 2-fold dilutions in blocking buffer and assayed for immunoglobulins and specific antibodies by RIA as described in Chapter 2.

i) Influence of infant age on immunoglobulin production by unstimulated cells.

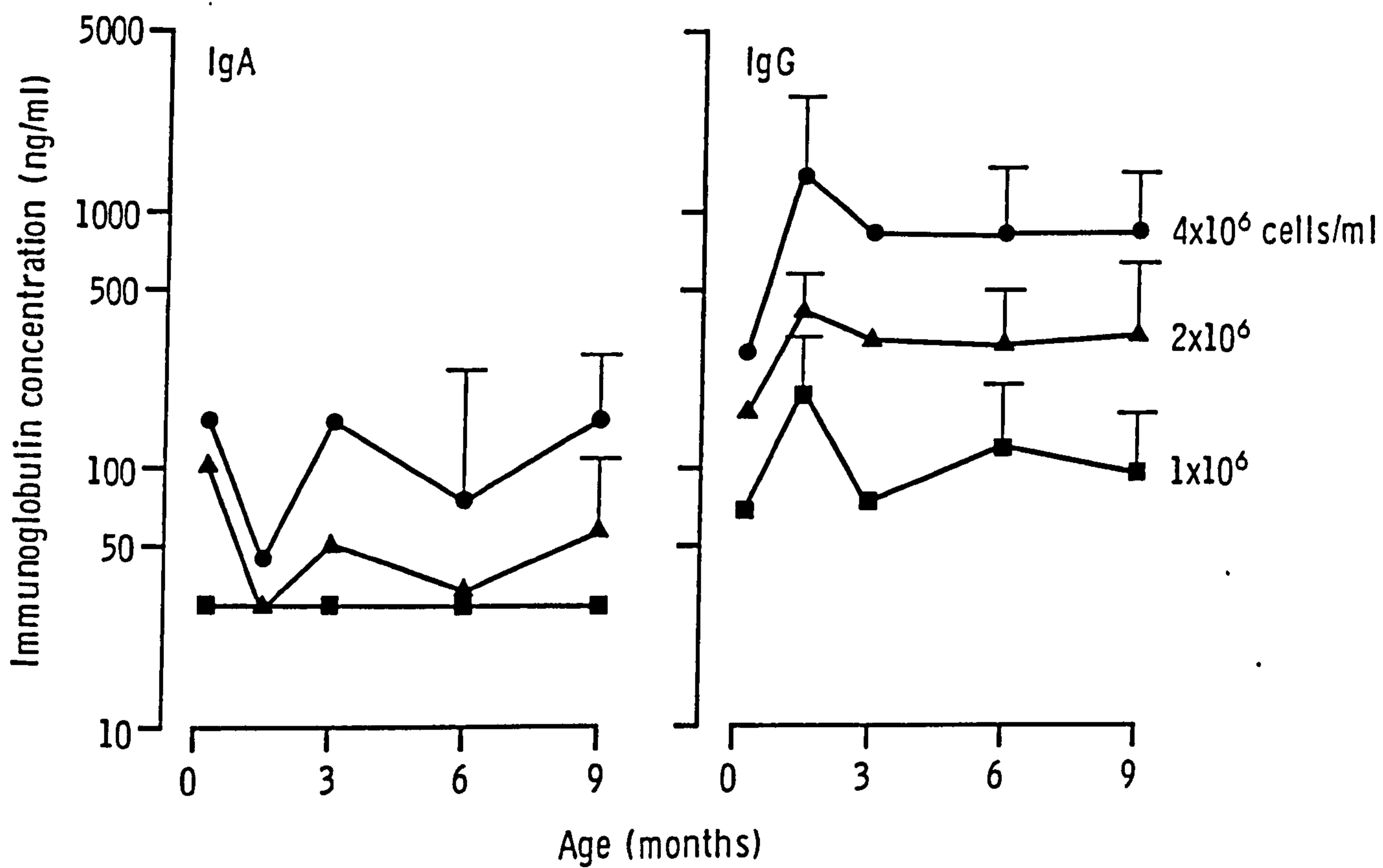
Few samples from infants at 6 days, 6 weeks and 3 months of age provided sufficient cells for studies of both proliferation and immunoglobulin production (n= 3, 3 and 2 respectively). All but one of these infants were bottle-fed. The effect of age on total IgM and IgG production by 29 samples at 3 cell concentrations is shown in Fig. 5 - 1. IgM production was low in all cultures (geometric mean = 150 ng/ml at 4×10^6 cells/ml) and changed little with age. IgG production was more variable. It was low in all 3 samples from 6 day old infants, (75-740 ng/ml at 4×10^6 cells/ml) but was considerably higher in the 3 cultures from 6 week old infants (1040 - 1825 ng/ml at 4×10^6 cells/ml). From 3m to 9m the geometric mean of IgG secreted remained constant, although there was wide variation, with the range at 4×10^6 cells/ml being 160 - 3620 ng/ml.

ii) Influence of breast- or bottle-feeding on immunoglobulin production by unstimulated PBM.

The absence of sufficiently large blood samples from breast-fed infants at 6 days and 6 weeks prevented any comparisons at this age.

Figure 5 - 1

Spontaneous immunoglobulin secretion by PBM cells from infants up to 9 months of age



In retrospect, this was particularly unfortunate as the proliferative responses in unstimulated cells showed the greatest differences between the two feeding groups at these two ages (see Fig 4 - 18). Fig. 5 - 2 shows IgM and IgG production from breast- (n=15) and bottle-fed (n=8) infants between 3 and 9 months. Although the mean IgM secretion was slightly lower in the breast-fed group and IgG secretion was slightly higher in this group, particularly at lower cell concentrations, these differences were not significant.

3) Response to PWM

Cultures were stimulated with 0.1 or 1.0 μ g/ml PWM. Total IgG production showed a small rise (less than 2-fold) in only 2/8 breast-fed and 0/8 bottle-fed infants. IgM production was slightly increased in 4/16 infants (in 3/16 increases were 2-fold or less) but for the remaining infants, IgM production was similar to or lower than in unstimulated cultures (Table 5 - 1).

4) Response to Tetanus Toxoid.

i) Titration for optimal dose of antigen.

Many of the cultures were set up with a range of tetanus toxoid doses. The antigen titration curve shown in Fig. 5 - 3 is an average of the results from 17 experiments. The optimal dose of TT for total IgM production was 0.001 Lfu/ml, with higher and lower doses inducing slightly lower quantities of IgM. This dose was used subsequently.

ii) Total IgM production.

Fig. 5 - 4 shows the increase in total IgM production in response to 0.001 Lfu/ml TT at 3 cell concentrations for both breast- and bottle-fed infants. These results, together with the ages and

Figure 5 - 2

Spontaneous immunoglobulin secretion by PBM cells from breast- and bottle-fed infants aged 3-9 months

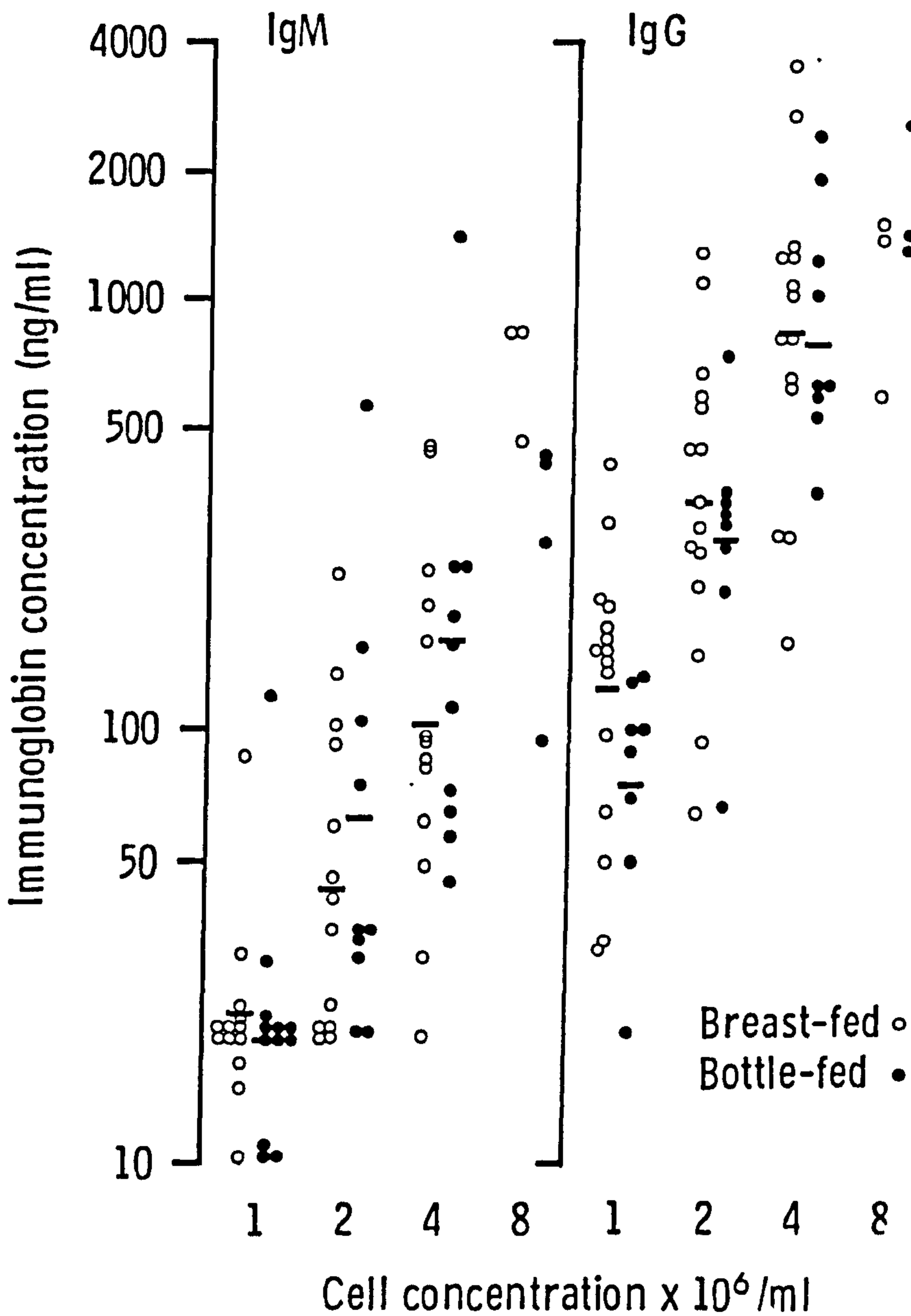


TABLE 5 - 1

IgM response to PWM stimulation

Feeding group	Infant no.	Age	4 X 10 ⁶ cells/ml			Fold-increase
			0	PWM (µg/ml) 0.1	1.0	
Breast	12	6m	80*	690	487	6
	14	"	30	53	-	-
	17	"	235	-	235	-
	18	"	445	-	310	-
	05	9m	61	-	57	-
	02	"	96	-	96	-
	14	"	49	86	106	2
	09	"	192	-	350	2
	12	"	93	114	136	-
Bottle	26	6wk	46	-	30	-
	20	3m	72	-	30	-
	19	"	242	-	252	-
	15	6m	65	-	127	2
	01	9m	114	-	150	-
	04	"	215	-	240	-
	30	"	1434	-	1434	-

* IgM in ng/ml

Figure 5 - 3

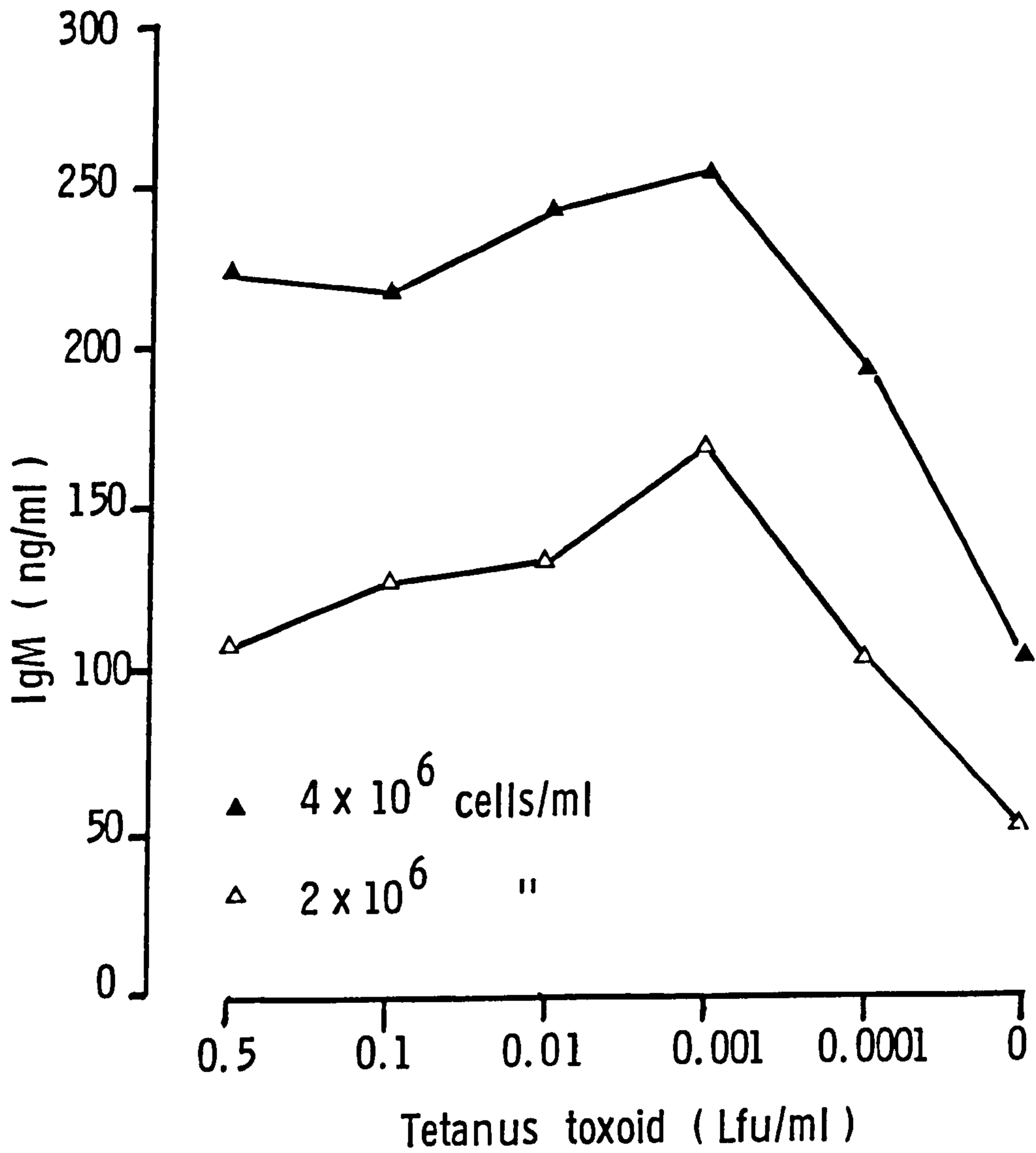
Titration of tetanus toxoid for immunoglobulin production *in vitro*.

Figure 5 - 4

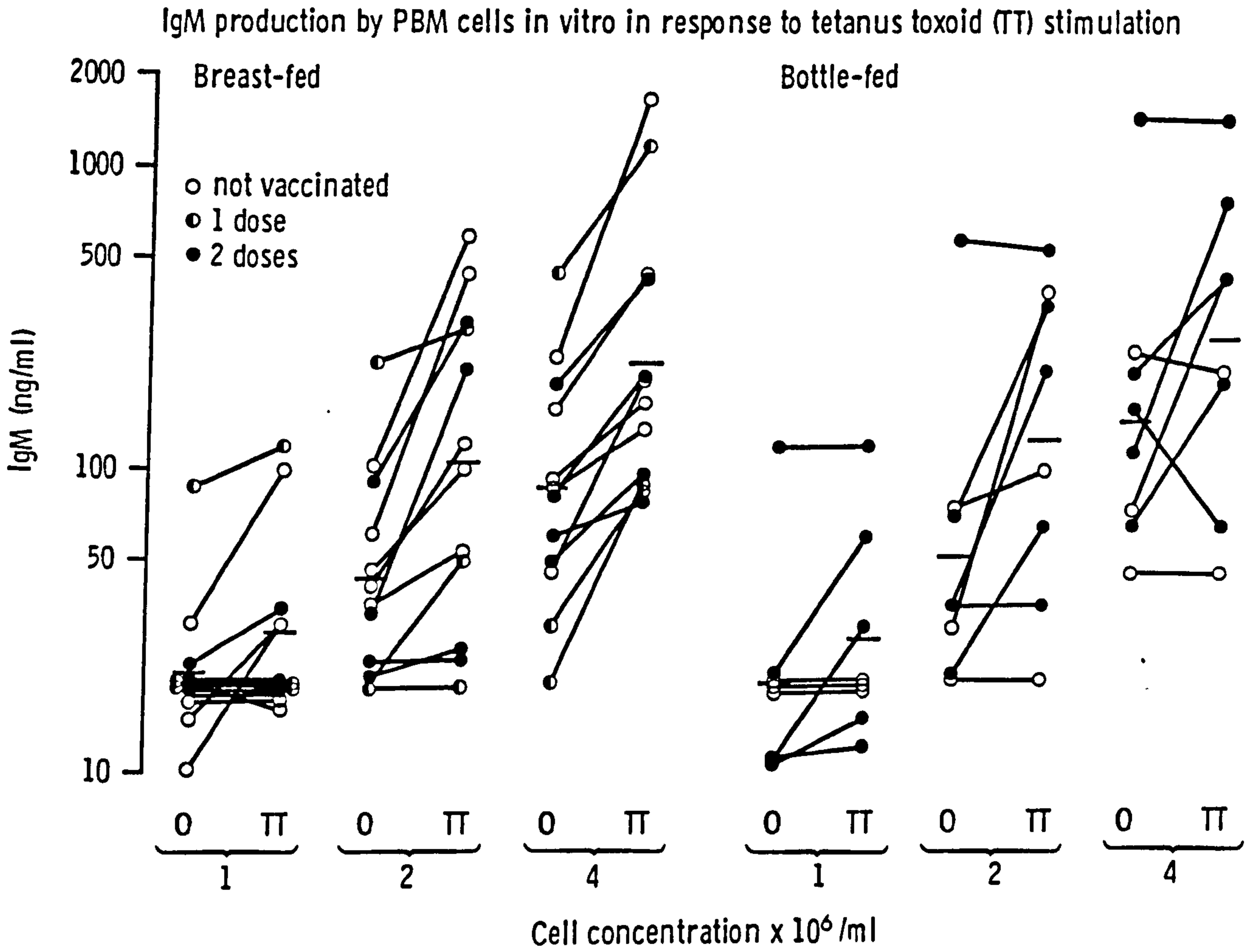


TABLE 5 - 2

TOTAL IgM PRODUCTION IN RESPONSE TO STIMULATION
WITH 0.001 Lfu/ml TETANUS TOXOID

FEEDING GROUP	INFANT NO.	AGE	VACCINATION DOSES	FOLD-INCREASE*
BREAST	31	6dy	-	3
	11	6m	-	1.5-3
	12	"	-	2-4
	17	"	-	2-8
	12	9m	-	0-2
	10	6m	1	2-3
	14	"	1	0-3
	18	"	1	1.5-3
	02	9m	2	0-5
	14	"	2	0-2
	09	"	2	2-3
	05	"	3	0
BOTTLE	26	6wk	-	0
	20	3m	-	0-10
	19	"	-	0
	15	6m	2	2-3
	04	9m	2	2-5
	01	"	2	4-7
	29	"	2	0
	30	"	2	0

* = Increase over IgM production in unstimulated PBM cells for 3 cell concentrations; 1, 2 and 4 X 10⁶ cells/ml.

vaccination status of the infants are also shown in Table 5 - 2. In 9/12 breast-fed and 4/8 bottle-fed infants, there was more than a 2-fold increase in IgM production on stimulation with TT. Increase in total IgM was not correlated with age or vaccination status, as some newborn or older non-vaccinated infants showed up to a 10-fold increase in IgM production, while some vaccinated infants showed no increase in response to TT stimulation. There were no significant differences between the two feeding groups in total IgM production after TT stimulation.

iii) Total IgG production.

Stimulation with TT (0.0001 to 0.5 Lfu/ml) produced little or no increase in total IgG production by unseparated cells. Only 2/13 breast-fed and 0/9 bottle-fed infants showed an increase, and this increase was less than 2-fold (Table 5 - 3).

iv) Specific antibody production.

All supernatants were assayed for IgG anti-TT antibodies and some were also assayed for IgM anti-TT. Specific antibodies were not detected in any supernatant (i.e. levels were <5ng/ml). The increased IgM produced in TT stimulated cultures must therefore be the result of antigen non-specific polyclonal activation of B cells.

5) IgA production *in vitro*.

Pittard and Bill (1977) have demonstrated a factor in milk which stimulates cord blood lymphocytes to differentiate into IgA secreting cells *in vitro*. It was therefore decided to investigate *in-vitro* synthesis of IgA by cells from a few breast- and bottle-fed infants. The results from cultures at 4×10^6 cells/ml of 7 breast-fed and 6

TABLE 5 - 3
EFFECT OF TETANUS TOXOID ON TOTAL IgG SECRETION
BY UNSEPARATED INFANT PBM CELLS.

Age INF NO.	CELL CONCENTRATION X 10 ⁶ /ml						FOLD- TT INCREASE
	0	1 TT	0	2 TT	0	4 TT	
BREAST-FED							
31 6dy	170*	140	380	300	740	643	-
10 6m	190	170	453	686	1370	1670	-
11 "	170	100	343	226	850	600	-
12 "	155	130	453	453	940	1000	-
17 "	37	15	150	60	280	180	-
14 "	50	50	65	50	160	300	-
18 "	65	30	220	150	620	425	-
12 9m	98	98	268	268	820	820	-
02 "	300	280	1114	1114	3620	2950	-
14 "	150	210	560	485	1280	2840	0-2
17 "	200	200	1300	1300	1050	3000	0-3
09 "	140	170	258	310	665	1080	-
05 "	34	25	95	85	288	210	-
GEOMETRIC MEAN	111	120	315	273	731	815	
BOTTLE-FED							
26 6wk	200	126	394	437	1040	690	-
20 3m	50	50	343	130	640	450	-
19 "	100	100	299	140	1040	520	-
15 6m	134	95	318	378	1242	1010	-
13 9m	130	120	365	217	640	522	-
01 "	88	37	268	101	540	290	-
04 "	100	100	210	268	600	350	-
30 "	70	85	757	378	2485	1160	-
GEOMETRIC MEAN	101	83	344	225	905	562	

* IgG ng/ml

TT = 0.001 Lfu/ml

TABLE 5 - 4

TOTAL IgA PRODUCTION BY INFANT PBL IN VITRO

FEEDING GROUP	NO.	AGE	STIMULATED WITH			IgA as a % of IgG
			O	TT	PWM	
BREAST	31	6dy	15*	15	-	2
	17	6m	110	96	96	39
	18	"	160	160	210	26
	12	"	350	350	310	37
	12	9m	675	775	510	82
	02	"	940	710	660	30
	09	"	548	1023	1550	82
BOTTLE	15	6m	608	590	460	49
	04	9m	490	410	390	82
	13	"	370	210	100	62
	01	"	460	255	187	85
	29	"	200	230	-	56
	30	"	2350	1662	1175	95

* IgA in ng/ml

bottle-fed infants are shown in Table 5 - 4. No significant differences were apparent between the IgA production in the two groups, although the number of infants in each feeding group of the same age was small. Both breast- and bottle-fed infants at 6 and 9 months secreted IgA at between 25-80% of IgG levels. The one 6 day infant tested (breast-fed) did not secrete detectable levels of IgA (<15 ng/ml). In general, IgA secretion *in vitro* was not increased by stimulation with TT or PWM (Table 5 - 4).

SECTION B - PRODUCTION OF SPECIFIC ANTIBODY

1) Standardisation of lipid in serum-free medium.

After this study had begun, work on adult B cell function in serum-free medium indicated that B cells had a critical requirement for lipid and that the lipid in commercially prepared powders used in the experiments above was poorly soluble, resulting in loss of lipid on filter sterilisation (Farrant *et al.*, 1984). The poor buffering capacity of the serum-free medium in air also resulted in an unacceptably high pH during long cell separation procedures. A series of cultures on infant cells was therefore set up using Leibovitz medium (L-15, Flow Laboratories) for cell preparation and a serum-free medium base (Gibco) supplemented with soybean lipid, transferrin and delipidated BSA for culture (see Chapter 2). Cells were stimulated with PWM (0.05µg/ml) and TT (0.001Lf_u/ml). The results shown in Table 5 - 5, indicate proliferative responses at days 3 and 4 of culture and total IgM and IgG production by 8 days, using the unsupplemented and supplemented media. Proliferative responses were slightly increased at 1×10^6 cells/ml but were similar at 2 and $4 \times$

TABLE 5 - 5

EFFECT OF SUPPLEMENTING SERUM-FREE CULTURE MEDIUM ON IMMUNOGLOBULIN PRODUCTION

PROLIFERATION		DAY 3				DAY 4						
		1		2		4		1		2		4
INF NO.	TT	PWM	U*	S	U	S	U	S	U	S	U	S
12	-	-	11**	25	13	38	32	42	24	90	34	85
	+	-	14	161	107	277	392	387	28	153	291	255
	-	+	16	223	157	338	663	592	26	176	335	428
14	-	-	28	-	45	-	96	-	22	314	32	197
	+	-	66	-	749	-	1076	-	155	505	1070	848
	-	+	563	-	2767	-	3530	-	1008	1415	4093	1960

IMMUNOGLOBULIN PRODUCTION		IgM				IgG						
		1		2		4		1		2		4
INF NO.	TT	PWM	U	S	U	S	U	S	U	S	U	S
12	-	-	17***	50	35	43	93	145	98	250	268	574
	+	-	15	278	53	52	167	507	98	241	268	615
	-	+	15	43	35	92	114	692	125	217	268	574
14	-	-	30	30	30	30	49	46	150	200	560	600
	+	-	30	60	25	40	92	130	210	230	485	560
	-	+	30	227	30	30	86	114	180	230	485	560

Infants aged 9 months; TT = 0.001 Lf units/ml; PW = 0.05 µg/ml
 * U = unsupplemented, S = supplemented with soybean lipid, TF and BSA.
 ** Proliferation expressed as cpm
 *** ng/ml immunoglobulin

10^6 cell concentrations. Total IgM and IgG production were also slightly enhanced using this medium, particularly at lower cell concentrations, but no specific anti-TT antibody was detected following stimulation with TT.

2) Addition of growth and differentiation factors for B cells.

Work on adult PBM cultures indicated that addition of a lectin-free supernatant from PWM stimulated cultures increased the proportion of immune donors showing an *in-vitro* specific antibody response to TT antigen (North and Brenner, 1983). Samples of these B cell growth and differentiation factors (BCGF) were kindly donated by Dr M.K.Brenner. Briefly, BCGF had been prepared by culturing irradiated T cells with autologous B cells (4:1 T:B cells) from TT-immune donors in serum-free medium containing $4\mu\text{g/ml}$ PWM. After 48 hours, cells were washed and recultured for a further 72 hours in fresh serum-free medium. PWM was removed from the culture supernatants by passage down a sepharose 4B column to which rabbit anti-PWM had been coupled and the supernatant used contained less than 3ng/ml PWM ($<150\text{pg/ml}$ of final culture medium). Addition of these supernatants to cultures of adult cells, in addition to enhancing specific antibody secretion in an antigen-dependent manner, also induces polyclonal IgM and IgG synthesis (North and Brenner, 1983). Effect of addition of BCGF to unseparated infant PBL is shown in Table 5 - 6. Proliferative responses measured in parallel are also shown on this table for day 4 of harvest from the 9 month sample of infant 17. BCGF alone increased polyclonal IgM synthesis 2-12 fold in 6/7 infants, but caused little increase in total IgG, in spite of greatly increased proliferative responses. Addition of TT to cultures

TABLE 5 - 6

EFFECT OF B CELL GROWTH FACTORS ON IMMUNOGLOBULIN PRODUCTION BY UNSEPARATED INFANT PBM.

Inf. No.	Age	Addn.	TOTAL IgM (ng/ml)				TOTAL IGG (ng/ml)				FOLD-				
			1	2	4		1	2	4						
BREAST															
05	9m	-	20	27	23	51	61	114	2	34	85	95	144	288	210
		TT	20	20	23	46	78	86	0-2	25	70	85	121	210	320
17	6m	-	15	160	60	285	235	330	0-10	37	54	150	130	280	205
		TT	30	140	450	305	1690	485	0-3	15	30	60	72	180	150
17	9m	-	50	70	135	300	455	850	2	200	3430	1300	1800	1050	1400
		TT	280	131	1120	227	1120	600	-	200	450	1300	1800	3000	3430
09	9m	-	23	100	92	330	192	562	3-4	143	258	258	535	666	1120
		TT	35	140	300	1075	440	1250	3-4	170	170	310	465	1080	975
BOTTLE															
15	9m	-	30	80	33	172	57	212	3-5						
		TT	80	1160	100	1120	172	487	3-12						
29	9m	-	10	12	35	70	160	57	-	20	30	67	67	357	244
		TT	12	12	35	35	65	46	-	25	25	60	60	105	114
30	9m	-	120	120	575	1075	1434	1434	0-2	70	85	757	378	2485	1330
		TT	120	120	540	407	1434	1087	-	85	70	378	330	1160	1045

Proliferation (cpm)

No.	Age	Day 3		Day 4			
		-	+	-	+		
17	9m	40	305	38	824	86	1650
		TT	295	440	1045	1490	1453
		Day 4					
	9m	163	543	168	1236	157	2522
		TT	679	1287	1870	2754	1965

containing BCGP, stimulated a further increase in IgM secretion in 3/7 infants, with the lower cell concentrations showing the greatest increases. However, no specific antibody was detected, even in cultures from vaccinated infants.

3) Depletion of monocytes.

Although the presence of monocytes is essential for immunoglobulin production *in vitro* (Gmelig-Myeling and Waldmann, 1981), the percentage in unseparated adult PBM has been shown to be greater than optimal for antibody production (Montazeri *et al.*, 1980). Experiments were therefore conducted, using immune adult donors, to try to obtain specific antibody secretion in unseparated PBM with reduced monocytes.

i) Adult cell cultures.

PBM were separated from heparinised blood as described previously (Chapter 2). Cells were washed twice in L-15 medium and resuspended in Iscove's serum-free medium containing added supplements of lipid, TF, BSA and 10% heat inactivated FCS. The cell concentration was adjusted to 5×10^6 cells/ml. Cells were then transferred to a 50mm plastic petri dish (Nunc) and placed in a humid incubator containing 5% CO₂, at 37°C for 90 minutes to allow the cells to adhere. The petri dish was rocked gently several times and non-adherent cells were removed, washed twice in L-15 and resuspended in IMDM plus supplements and antibiotics for culture. Culture supernatants were assayed for total IgM and IgG anti-TT only and the results are shown in Table 5 - 7.

TABLE 5 - 7

EFFECT OF MONOCYTE DEPLETION ON IgM AND SPECIFIC ANTIBODY
PRODUCTION IN VITRO BY ADULT PBM CELLS

Additions to cultures			DONOR SS 4×10^6 CELLS/ML			
			Total IgM (ng/ml)		IgG anti-TT (ng/ml)	
F	TT	PWM	Adherence		Adherence	
			Pre-	Post-	Pre-	Post-
-	-	-	72*	25	<10	<10
-	+	-	72	<20	<10	<10
-	-	+	1120	2090	<10	20
+	-	-	1380	910	94	<10
+	+	-	395	3165	<10	370
+	-	+	790	1950	<10	<10

F = B cell growth factors

TT = Tetanus toxoid, 0.001 Lf units/ml

PWM = Pokeweed mitogen, 0.05 μ g/ml

* Results are from pooled duplicate wells

a) Total IgM secretion.

Cells cultured without depletion of monocytes responded to PWM or BCGF alone (but not TT) with production of over $1\mu\text{g/ml}$ IgM; addition of BCGF and PWM together did not further increase IgM production. After depletion of monocytes, the IgM response to PWM was enhanced, with production of $2\mu\text{g/ml}$ IgM in the presence or absence of BCGF. In the presence of BCGF and TT, even larger quantities of IgM were secreted ($>3\mu\text{g/ml}$).

b) IgG anti-TT antibody secretion.

Cells cultured without depletion of monocytes and in the absence of BCGF secreted no detectable IgG anti-TT antibody. Addition of BCGF induced secretion of a small quantity of IgG anti-TT (94ng/ml), but this was not enhanced by the addition of TT to the cultures. After monocyte depletion, in the presence of BCGF and TT, considerably higher levels of IgG anti-TT were secreted (370ng/ml) than in the presence of BCGF or TT alone. This experiment was also conducted using defibrinated blood to ensure that platelets were not having an inhibitory effect but no specific antibody was detected in these cultures (results not shown).

ii) Infant cell cultures.

Five experiments were then set up using heparinised blood from 9 month-old vaccinated infants. The results are shown in Table 5 - 8. Unlike the adult cells (see Table 5 - 7), total IgM production was not enhanced by the addition of PWM and in only one infant was it enhanced by the addition of BCGF and TT together, although it was enhanced up to 20-fold by BCGF alone in 3/5 infants. In the presence of BCGF and TT, IgG anti-TT was detected in only 2/5 infants and at very low levels. One infant (25) produced more IgG anti-TT in response to TT

TABLE 5 - 8

EFFECT OF DEPLETION OF ADHERENT CELLS ON IMMUNOGLOBULIN PRODUCTION
BY INFANT PBM IN VITRO

INFANT NO.	19	24	22	25	28
AGE AT VACCINATION	4.3, 6.5m	3, 5m	4m	3, 8m	4, 8.5m
CELL CONC. ($\times 10^6$ /ml)	4	4	4	4	4
F	-	-	-	-	-
TT	-	-	-	-	-
PWM	-	-	-	-	-
IgM	50*	400	185	25	150
GxTT	<5*	<5	<5	<5	8
IgM	114	114	<20	43	55
GxTT	"	"	"	720	<5
IgM	150	190	"	-	70
GxTT	"	"	"	-	"
IgM	2018	1950	"	120	86
GxTT	"	"	"	<5	"
IgM	450	155	"	46	50
GxTT	23	"	"	35	"
IgM	370	252	"	-	53
GxTT	"	"	"	-	"

TT = 0.001 Lf units/ml * = ng/ml

PW = 0.05 μ g/ml

- = not tested

in the absence of BCGF than in its presence.

4) Depletion of T cells.

The observation that infant PBM cells proliferate but do not synthesise large quantities of immunoglobulin in the presence of BCGF and TT, could be explained if the T cells were proliferating at a greater rate than the B cells. This might actively suppress B cell differentiation or might produce non-specific inhibition by depletion of nutrients. It was therefore decided to attempt to reduce the proportion of T cells present by using monoclonal antibodies to surface antigens.

i) Method for depletion of T cells.

The technique involved mixing the PBM cells with the appropriate monoclonal antibody and then removing the coated cells by panning on a petri-dish coated with anti-mouse IgG. Monoclonal antibodies were the gift of Dr P.Beverley (I.C.R.F. Tumour Unit, University College, London). UCHT 1 was a pan-T monoclonal directed against all human T cell subgroups (equivalent to OKT3). UCHT 4 was directed against suppressor and cytotoxic T cells (equivalent to OKT8).

a) Coating of plates with anti-mouse IgG.

The procedure was conducted using aseptic techniques and all solutions were filter sterilised. Petri-dishes (50mm, Nunc) were coated with 7ml of a solution containing 100 μ g/ml poly-L-lysine (Sigma, 300,000 MW for tissue culture) in 0.1M carbonate buffer, pH 9.6, for 1hr at RT. The dishes were washed three times in PBS. Affinity purified rabbit anti-mouse IgG (from Dr P.Beverley) was diluted in 0.05M tris buffer, pH 9.4, to 40 μ g/ml and 7ml of this was added to the poly-L-lysine coated dishes. Plates were incubated overnight at 4°C in a humid box,

washed three times in PBS, filled with 7ml PBS containing 5% BSA and incubated a further 1hr at RT. The dishes were again washed three times in PBS and then once in PBS containing 5% heat inactivated FCS.

b) Reaction of T cells with monoclonal antibodies

PBM cells were separated from heparinised blood from a TT-immune adult donor in the usual way and washed 3 times in L-15 medium. Cells were resuspended in IMDM plus supplements to give 5×10^6 cells/ml. The cell suspension was aliquotted into four 10ml conical base centrifuge tubes (Falcon Plastics) and to these were added one of the following:-

UCHT 1 1/50 final concentration

UCHT 1 1/500 "

UCHT 4 1/50 "

UCHT 4 1/500 "

The tubes were rocked and placed on ice for 30-35 minutes. Cells were then spun, washed twice in L-15 and resuspended in 2ml PBS containing 5% heat inactivated FCS. T cells coated with monoclonal antibodies were then removed by incubating these cell suspensions in the rabbit anti-mouse IgG coated petri-dishes for 70min at RT. The dishes were swirled half-way through this incubation. Non-adherent cells were removed by gentle squirting with a Pasteur pipette, washed 3 times in L-15 and cultured in IMDM plus supplements and Pen/Strep. Cultures were set up at 1, 2 and 4×10^6 cells/ml and supernatants were assayed for total IgM and specific IgG anti-TT only.

ii) Antibody production

Maximal IgM was produced at the highest cell concentration and these results are shown in Table 5 - 9. After depletion of all T cell subsets with UCHT 1, IgM secretion was greatly increased by PWM and TT stimulation but not BCGF. After suppressor cell depletion, large

TABLE 5 - 9

EFFECT OF T CELL DEPLETION ON IMMUNOGLOBULIN SECRETION BY ADULT PBL

DONOR BC 4×10^6 CELLS/ML

Total IgM (ng/ml)

Additions			UCHT 1		UCHT 4	
F	TT	PWM	1/50	1/500	1/50	1/500
-	-	-	<50	<50	160	<50
-	+	-	610	800	100	950
-	-	+	900	600	1430	3450
+	-	-	<50	60	2665	1180
+	+	-	200	300	220	1050
+	-	+	50	1000	2320	2550

No IgG anti-TT was detected in any supernatant

quantities of IgM (up to 3 μ g/ml) were secreted in response to PWM and BCGF stimulation and smaller quantities in response to TT (for the 1/500 dilution of UCHT 4). However, no specific IgG anti-TT was detected in any of the supernatants.

SECTION C - DISCUSSION

1) Immunoglobulin production by unseparated PBM cells.

Experiments with unseparated PBM cells, using hanging-drop microcultures in serum-free medium and RIA to assess Ig secreted into the supernatants, have shown that unstimulated infant cells will secrete IgM and IgG *in vitro*. When cultured at 4 X 10⁶ cells/ml, IgM (100ng/ml) is detectable in the supernatants of cell cultures from 6 days of age onwards, but synthesis does not appear to increase significantly with age up to 9 months. IgG is also detectable in supernatants from 6 days of age and although levels were higher in the supernatants from older infants, sample numbers were too low to draw any firm conclusions. IgA secretion was also detected in the few infants tested at 6 and 9 months but not in the one 6 day infant tested. Previous studies on cord blood lymphocytes (CBL) and infant PBL using plaque-forming cell (PFC) assays have detected very low numbers of PFC's in cultures of unstimulated cells (Andersson, Bird and Britton, 1980; Unander, Hammarstrom and Smith, 1983).

Stimulation by PWM induced a small increase in IgM secretion in only half the samples tested and did not enhance IgG or IgA secretion. Previous studies on CBL using serum-containing culture media and a PFC assay have also indicated reduced responses to PWM compared with adult

PBL, with no detectable IgG or IgA PFC and a reduced number of IgM PFC (Wu *et al.*, 1976; Hayward and Lawton, 1977; Andersson, Bird and Britton, 1980; Miyagawa *et al.*, 1980; Unander, Hammarstrom and Smith, 1983). This reduced IgM response has been attributed to a helper T cell defect (Hayward and Lawton, 1977; Andersson, Bird and Britton, 1980) which disappears during the first few months of life (Andersson, Bird and Britton, 1981). PWM has also been shown to induce prosuppressor T cells in CBL cultures (Waldmann and Broder, 1982). Andersson *et al.*, (1983) have demonstrated a population of suppressor T cells from PWM-induced CBL which will inhibit immunoglobulin secretion by adult B cells.

When T independent B cell activators such as EBV (Andersson, Bird and Britton, 1981) or SAC (Unander, Hammarstrom and Smith, 1983) are used, CBL can be induced to secrete adult levels of IgM. IgG PFC were also induced in SAC (but not EBV) stimulated cultures, although these workers used a culture medium containing human AB serum which is known to give misleading results in adult systems (Waldmann and Broder, 1982). The finding in this current study that IgG was detectable in the supernatants of unstimulated serum-free cell cultures from all 6 day and 6 week old infants may reflect a greater sensitivity of the RIA technique over PFC assays. The results of studies on IgA secretion in this serum-free system were consistent with previous work on IgA secretion. IgA PFC were not induced in cultured CBL by PWM, EBV or SAC (Andersson, Bird and Britton, 1981; Unander, Hammarstrom and Smith, 1983), although sequential studies indicated IgA PFC appeared between 2-6 months of age (Andersson, Bird and Britton, 1981).

In the present study, stimulation with TT increased IgM production (up to 10-fold) in almost all samples but did not increase IgG or IgA secretion. Work on adult cells has also indicated an increase in polyclonal IgM response to this antigen (Brenner and Munro, 1981). However, no increase in specific antibody was detected in the TT-stimulated infant cell cultures. Although it is possible that TT is acting as a mitogen, there has been no evidence from previous work that TT is mitogenic. This non-specific stimulation is possibly due to endotoxin in the TT preparation (Rethy, 1983).

Comparison of immunoglobulin synthesis in breast- and bottle-fed infants was difficult due to the small number of samples with cells remaining for these studies, particularly in the younger infants. A comparison between the older infants indicated slightly higher levels of IgM in the supernatants from bottle-fed infants but the differences were not significant. This was particularly unfortunate since the largest differences in spontaneous proliferative responses occurred in the 6 day and 6 week old infants.

2) Attempts to enhance immunoglobulin and specific antibody production *in vitro*.

The modifications to the lipid content of the serum-free medium and use of a more highly buffered medium during cell separation procedures have been shown to enhance B cell function in adult cultures (Farrant *et al.*, 1984). In the cultures of infant cells, total IgM and IgG secretion were enhanced, particularly at the lower cell concentrations, but this modification alone was not sufficient to allow specific antibody production.

Addition of B cell growth and differentiation factors to the cultures greatly enhanced IgM secretion, but unlike adult cultures (North and Brenner, 1983) did not stimulate cells to differentiate and secrete IgG. Addition of TT to these BCGF stimulated cultures further enhanced total IgM production, but no specific antibody was detected, even in cultures of cells from vaccinated infants. In adults, it has been shown that, even using optimal T, B and monocyte numbers, only in a very low proportion of TT-immune donors can PBM be stimulated to secrete specific antibody *in vitro* (Brenner *et al.*, 1983). This proportion of '*in-vitro* responders' can be greatly increased by addition of lectin-free supernatants from PWM-stimulated PBM cell cultures which contain growth and differentiation factors for B cells, but there remains a proportion who still fail to respond *in vitro* (Brenner *et al.*, 1983). It is therefore not clear whether the unseparated infant PBM cells were not secreting specific antibody because they were '*in-vitro* non-responders', whether they were generally immature in some way, or whether conditions were still sub-optimal.

The presence of monocytes has been shown to be critical in adult immunoglobulin and antibody producing systems *in vitro* (Gmelig-Myeling and Waldmann, 1981) but the optimal level is about 5% compared with the higher percentage in PBM (Montazeri *et al.*, 1980). In this present study, depletion of monocytes in adult PBM preparations by adherence to plastic not only enhanced total IgM production in the presence of PWM or BCGF, but in the presence of BCGF and TT, stimulated secretion of specific IgG anti-TT antibodies. Similar monocyte depletion procedures in 9 month old vaccinated infants did not, however, have the same effect. With infant cells, total IgM

secretion was still not enhanced by PWM, although in some infants it was enhanced by BCGF. This supports the finding of Andersson *et al.*, (1981) that the lack of response to PWM by CBL is due to a helper T cell defect, rather than a B cell defect. Also, addition of BCGF and TT stimulated only very low levels of specific antibody in 2/5 infants. It is possible that these infants are in the '*in-vitro* non-responders' group, as clearly they had made vigorous specific antibody responses to TT vaccination *in vivo*. However, it was also possible that the helper T cell deficiency, apparent in PWM driven systems, was retarding specific antibody production *in vitro*. The possibility of suboptimal conditions still remains.

Attempts to enhance further specific antibody production in adult cell cultures by depletion of T cells proved unsuccessful. Use of monoclonal antibodies showed that depletion of the suppressor/cytotoxic subset of T cells considerably enhanced IgM secretion in the presence of BCGF or PWM, but did not induce specific IgG anti-TT in an adult donor known to be an '*in-vitro* responder'. The technique still required large cell numbers and was not felt to be advantageous in that respect over conventional T cell rosetting techniques.

It would seem from these studies, that the B cells in peripheral blood of infants cannot be induced to secrete specific antibody *in vitro* without using large quantities of cells. Although absolute B cell numbers in newborn infant blood are higher than in adult blood, the ratio of suppressor T to helper T cells is also significantly higher (Thomas and Linch, 1983). In adult cultures using separated T and B cells, it has been noted that irradiated T cells (2000 rads)

give better help than non-irradiated cells (North and Brenner, 1983), and this has been attributed to the greater radiosensitivity of suppressor T cells than helper T cells (Keightly, Cooper and Lawton, 1976; Moretta *et al.*, 1977). Since infant PBM cells have a higher proportion of suppressor cells, it may be that separation and irradiation are crucial steps in attempts to get specific antibody production *in vitro*. The fact that two infants did produce small amounts, indicates that the appropriate cells are present in infants by 9 months.

The observation that infant cells respond to B cell growth and differentiation factors with production of IgM but not IgG, suggests that the large numbers of B cells present are early B cells. In adults, BCGF has been shown to act on activated B cells only, that is memory B cells or B cells which have been activated *in vitro* by the appropriate T cells (Brenner *et al.*, 1984). The fact that they do not act on resting B cells would indicate that the majority of infant B cells have not yet met antigen and the pool of memory cells is therefore much smaller than in adults.

SUMMARY

Unseparated infant PBM cells have been cultured in serum-free media using Terasaki plate hanging-drop microcultures and the supernatants have been examined by RIA for production of immunoglobulins and specific antibodies.

In unstimulated cultures, IgM was detectable at low levels (100 ng/ml or less) in supernatants from infants from 6 days of age, but at higher cell concentrations only. IgG was detected in all cultures

from infants of all ages and increased slightly with age. IgA was not detected in cultures from one 6 day old baby but was detected in cultures from all 6 and 9 month old infants.

In contrast to adult PBL cultures, PWM enhanced IgM production only slightly in a few older infants and had no effect on IgG or IgA secretion. Tetanus toxoid enhanced IgM production in most infants (15/20) but did not stimulate IgG or IgA production. In none of the cultures of unseparated PBM cells was specific anti-TT antibody detected, in spite of good proliferative responses to this antigen (see Chapter 4).

Comparison of immunoglobulin production in breast- and bottle-fed infants was difficult as the numbers in each group at each age were small, particularly under 3 months of age. At 6 and 9 months, IgM production was slightly higher in the bottle-fed group and IgG production was slightly higher in the breast-fed group but these differences were not significant. Nor were there any significant differences in the total IgM response to TT. It has therefore not been possible to correlate the differences in proliferative responses of cells from the two feeding groups (see Chapter 4) with *in vitro* immunoglobulin or antibody production.

Attempts to enhance immunoglobulin and specific antibody production in cultures of unseparated PBM produced further information about lymphocyte function in newborn infants. Addition of B cell growth and differentiation factors to cultures of infant PBM greatly enhanced IgM but not IgG production. In these BCGF stimulated cultures, PWM still failed to induce further immunoglobulin synthesis of any isotype. This suggests that the B cells in infant blood are

capable of secreting IgM up to adult levels, but the reduced differentiation into IgG and IgA secreting cells indicates that either the helper T cells necessary for differentiation into IgG secreting cells may be absent or immature, or that most of the B cells present in infants are early B cells and activated or memory B cells are greatly reduced. Depletion of monocytes from the infant PBM cells enhanced IgM secretion in the presence of BCGF, but did not enhance PWM induction of IgM, suggesting that high numbers of monocytes may also be having a suppressive effect.

Cultures were also assayed for specific IgG anti-TT in response to TT stimulation. In adult PBL cultures, depletion of monocytes, followed by addition of BCGF and TT resulted in specific antibody production in a TT-immune donor but in infant cell cultures, gave only very low levels of IgG anti-TT in 2/5 vaccinated infants tested. This low level of specific antibody production could be due to sub-optimal culture conditions, but might also be due to low numbers of *in vivo* TT-activated B cells or the helper T cell defect apparent in the PWM driven cultures. All these infants responded to TT vaccination *in vivo* with production of large quantities of specific IgG anti-TT, suggesting that the poor *in vitro* response may be a defect in the signals provided for the B cells under the present culture conditions. Techniques using monoclonal antibodies to reduce the numbers of all T cell subsets or the suppressor/cytotoxic subset, used large numbers of cells and were unfortunately not suitable for infant studies.

CHAPTER 6

IN VIVO STUDIES ON INFANT SERA

SECTION A - INTRODUCTION

1) Absorption of milk immunoglobulins

The extent of the absorption of intact macromolecules by the gut of the neonatal infant has been investigated for over 50 years, (reviewed by Leissring, Anderson and Smith, 1962). Most of the earlier studies used the technique of feeding high titre antisera to the infant, and measuring the increase in antibody titre in the infants' blood. The failure to demonstrate uptake by the neonatal gut has been attributed to the insensitivity of the techniques used to detect these antibodies. Improvement of the sensitivity for detection, has indicated that serum antibodies can be absorbed by the neonatal gut during the first few days of life (Leissring, Anderson and Smith, 1962). Initial attempts to show absorption of antibodies from human milk in breast-fed infants, by measurement of total IgG and IgM antibodies in the sera of these and bottle-fed infants, were unsuccessful (Vahlquist, 1958). However, following the discovery of serum IgA and a separate secretory immune system (Hanson, 1961), there was renewed interest in the gut absorption of immunoglobulins. The results of more recent studies are still somewhat conflicting. Yengar and Selvaraj, (1972) reported that IgG in the serum of breast-fed infants increased between birth (cord blood) and 5 days, whereas it decreased in bottle-fed infants. Ogra, Weintraub and Ogra (1977) demonstrated that IgA antibodies to polio appeared rapidly in the sera of newborn infants fed colostrum containing these antibodies, but absorption only took place during the first 24 hours after birth.

Saarinen, Pelkonen and Siimes (1979), however, showed an accelerated postnatal increase in the serum IgA levels of formulae-fed infants, which was apparent as early as 1 month, and was still significant at 6 months. They suggested that this was due to a higher antigenic load in the gut of the bottle-fed infant. Higher serum IgA in bottle-fed babies has also been recorded in pre-term infants (Savilahti, Jarvenpaa and Raiha, 1983), although these workers also noted that babies receiving mostly their own mother's milk had higher serum IgA levels than those receiving human milk-bank milk. Other workers have found no differences in the serum immunoglobulin levels of breast- and bottle-fed infants (Ammann and Stiehm, 1966; Kletter *et al*, 1971; Yap *et al*, 1979).

2) Stimulation of immunoglobulin production *in vivo*

Recently the demonstration of factors in milk which can stimulate cell growth and differentiation *in vitro* has led to the suggestion that these factors may have a similar function *in vivo*. Factors which can stimulate the growth of gut and epithelial tissues (Klagsburn, 1978, 1980; Tapper, Klagsburn and Neuman, 1979; Carpenter, 1980) are thought to be important in enhancing the maturation of the gut epithelium in the breast-fed infant.

Pittard and Bill (1979a, 1979b) have demonstrated that there are factors in milk which can stimulate adult peripheral blood lymphocytes to differentiate into IgA secreting plasma cells (but not into IgG secreting cells). Other workers have demonstrated *in vitro* secretion of lymphokines by breast milk cells (Goldman, 1977; Keller *et al*, 1981; Blau *et al*, 1983). It is possible that these factors may be absorbed by breast-fed infants and their immune systems stimulated to

mature.

To determine whether there is any early neonatal absorption of milk immunoglobulins, or stimulation of immunoglobulin production by growth factors absorbed from milk, it was decided to investigate not only total IgG, IgM and IgA, but also to assess the response of breast- and bottle-fed infants to specific antigens by measurement of serum antibodies. For this purpose, two antigens commonly encountered in early infancy were chosen. The first was tetanus toxoid, a protein antigen administered systemically in the standard vaccination protocol, and the second was *E.coli* lipopolysaccharide (LPS) 'O' antigen from a pool of commensal strains to which the infants would almost certainly be exposed via their normal gut flora very early in life.

3) Techniques

For the total immunoglobulin levels, the sera were assayed by laser nephelometry. This technique was very reliable for IgG, but proved insufficiently sensitive for the small quantities of IgM and IgA present in the sera of newborn infants. Total immunoglobulins were therefore also estimated by RIA. For the *E.coli* antibodies, indirect haemagglutination (IHA) was tried, but this technique used fairly large quantities of serum, and so both ELISA and RIA techniques were investigated. The relative technical merits of each assay were compared, and the insensitivity of IHA for detecting IgG antibodies is discussed below. The IHA technique was found to give very misleading results for the sera of newborn infants.

Tetanus toxoid antibodies were estimated routinely by a solid-phase RIA. Again, an ELISA technique was investigated, but the greater sensitivity of the RIA technique, together with the availability of a computer link for calculation of RIA results made this the method of choice. The standardisation of this assay with a monoclonal IgG anti-TT antibody and an affinity purified anti-TT serum standard resulted in an accurate and reproducible assay (see Chapter 2). The use of RIA for all immunoglobulin and antibody estimations enabled all the assays to be performed on as little as 50 μ l of serum.

SECTION B - IMMUNOGLOBULIN AND ANTIBODY ASSAYS

1) Nephelometry for Total IgG, IgM and IgA

These assays were done either by the Haematology Department, NPH, or the Division of Immunological Medicine, CRC. A laser nephelometer (Hyland, N.V. Travenol Laboratories S.A., Belgium) was used and fresh samples (stored at 4°C for up to 4 days) were assayed against LAS-R Multiparameter Reference standards (Set A, Hyland).

2) IHA for *E.coli* Antibodies

The technique of Neter, Bertram and Arbesman (1952) was adapted. Human group O red blood cells were washed in saline and 0.1ml packed cells were coated with 5ml *E.coli* 'O' LPS antigen for 30min at 37°C. These sensitised cells were washed and adjusted to a 1% suspension. Serum samples were inactivated for 30min at 56°C, 0.1ml of serum was then mixed either with 0.1ml phosphate buffered saline (PBS), or 0.1ml of 0.1M 2-mercaptoethanol (2-ME) in PBS. After incubation at 37°C for 30min, serial twofold dilutions were made in 25 μ l volumes in 'U' well

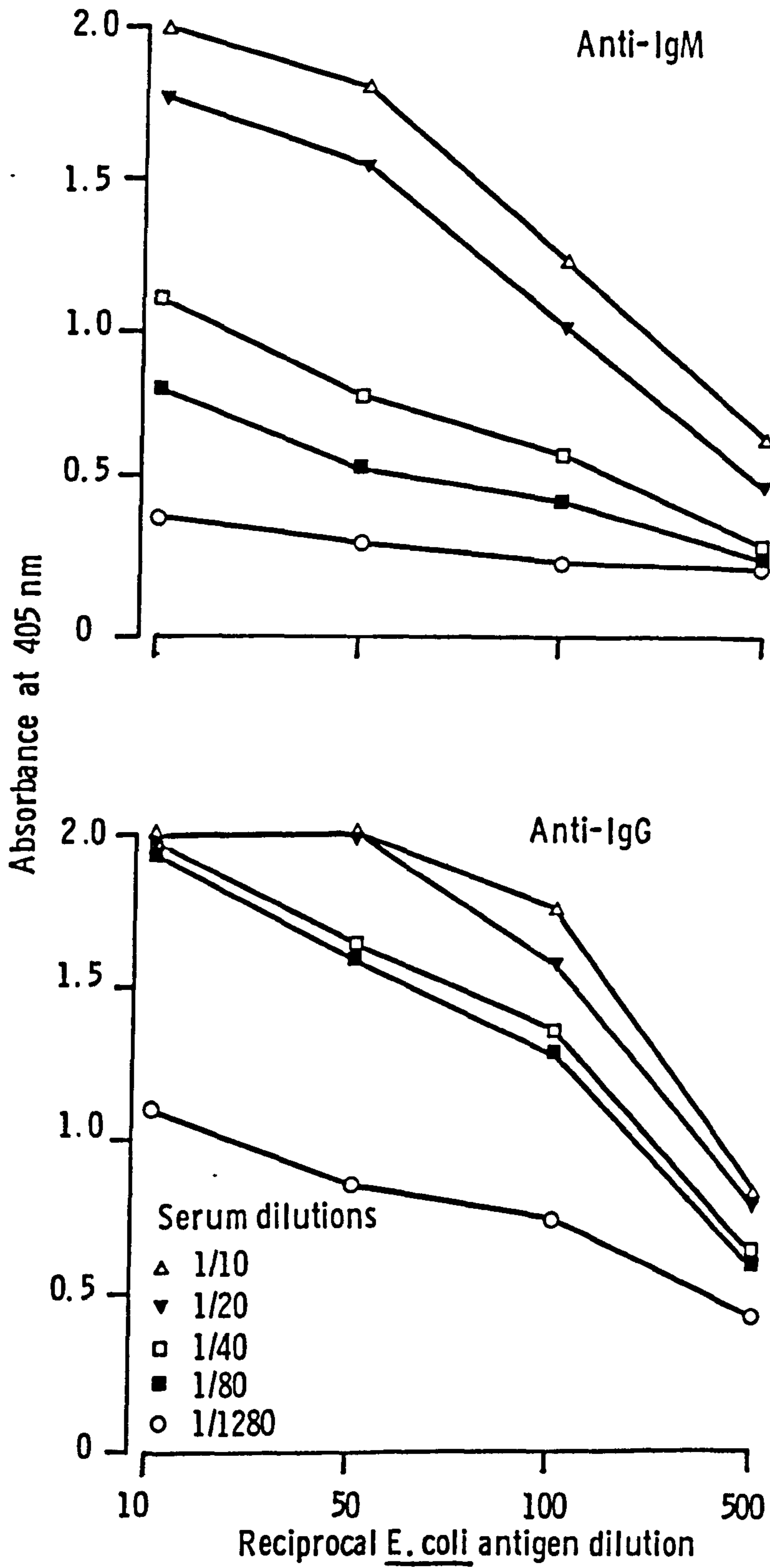
microtitre trays (Sterilin) and 25 μ l of coated RBC suspension added. Trays were incubated 3 hrs at 37°C and then overnight at 4°C. The titre was expressed as the highest dilution showing at least 20% agglutination of red cells. Titres resistant to 2-ME were assumed to be due to IgG antibodies (Robbins, Kenny and Suter, 1965).

3) ELISA for *E.coli* Antibodies

Flat bottomed microtitre trays (Dynatech) were coated with 100 μ l of a 1/10 dilution of the *E.coli* antigen pool in coating buffer (0.05M carbonate pH9.6, Don Whitley Scientific Ltd., West Yorkshire) for 2 hrs at 4°C and washed 3 times in PBS/Tween (Don Whitley). This optimal dilution was determined from a preliminary titration experiment (Fig 6 - 1). Serial dilutions of antisera were made in PBS/Tween, dispensed in 100 μ l volumes and the trays incubated 3 hrs at room temperature (RT). After further washing, 100 μ l of alkaline phosphatase conjugated rabbit anti-human IgG (Miles Laboratories), or similarly conjugated -IgM (Don Whitley) were added and incubated overnight at 4°C. Trays were washed and 100 μ l of substrate (p-nitrophenyl phosphate 1mg/ml, Sigma Chemical Co. Ltd., London) in diethanolamine buffer, (Don Whitley) added. Colour change was read on an ELISA plate reader (Titretek Multiscan, Flow Laboratories, Scotland) using a 405nm filter. Readings were taken at intervals up to 3 hrs. Initial experiments indicated that the optimal time for colour development was 30min for IgG antibodies and 2hrs for IgM antibodies.

Figure 6 - 1

E. coli antigen titration curve for ELISA



4) Solid-phase Radioimmunoassay method (RIA)

The assay was set up as described in Chapter 2. Sera were diluted in blocking buffer. Initial dilutions were 1/5, followed by 8 serial 4-fold dilutions. This gave a detection range of between 10ng-100µg/ml for specific antibodies, and 30ng-1mg/ml for total immunoglobulins. For levels of immunoglobulin higher than this, the dilution error was found to result in unacceptable reproducibility of the test (see below).

5) Statistics

Results of serum immunoglobulins and specific antibodies were log-transformed to normalise the distribution and means expressed are therefore geometric. Results were analysed by analysis of variance and significance was assessed by the F-test. Where differences between groups were tested for on single sampling occasions, a pooled t-test was used.

SECTION C - RESULTS

1) Comparison of Nephelometry and RIA for Total Immunoglobulins

i) IgG

When the variability of results for total IgG assayed by RIA were compared with the variability of the results by nephelometry, (using the method of Grubbs, 1948, as described by Shukla, 1973) RIA was found to have a significantly higher measurement error than nephelometry ($t=4.17$, $P=0.00028$). For total IgG estimations, therefore, the nephelometry results were used.

ii) IgM and IgA

The minimum sensitivity of the nephelometry technique for detecting these immunoglobulins in 0.1ml serum was 0.1mg/ml. All 6 day samples and most 6 week samples had less than this quantity of IgA, and most 6 day samples had less than this quantity of IgM. Above this minimum level, correlation between the two tests was very good, ($r=0.638$ $P<0.001$) and results expressed are the averages of the two tests.

2) Comparison of IHA, ELISA and RIA for *E.coli* Antibodies

i) Correlation of the tests

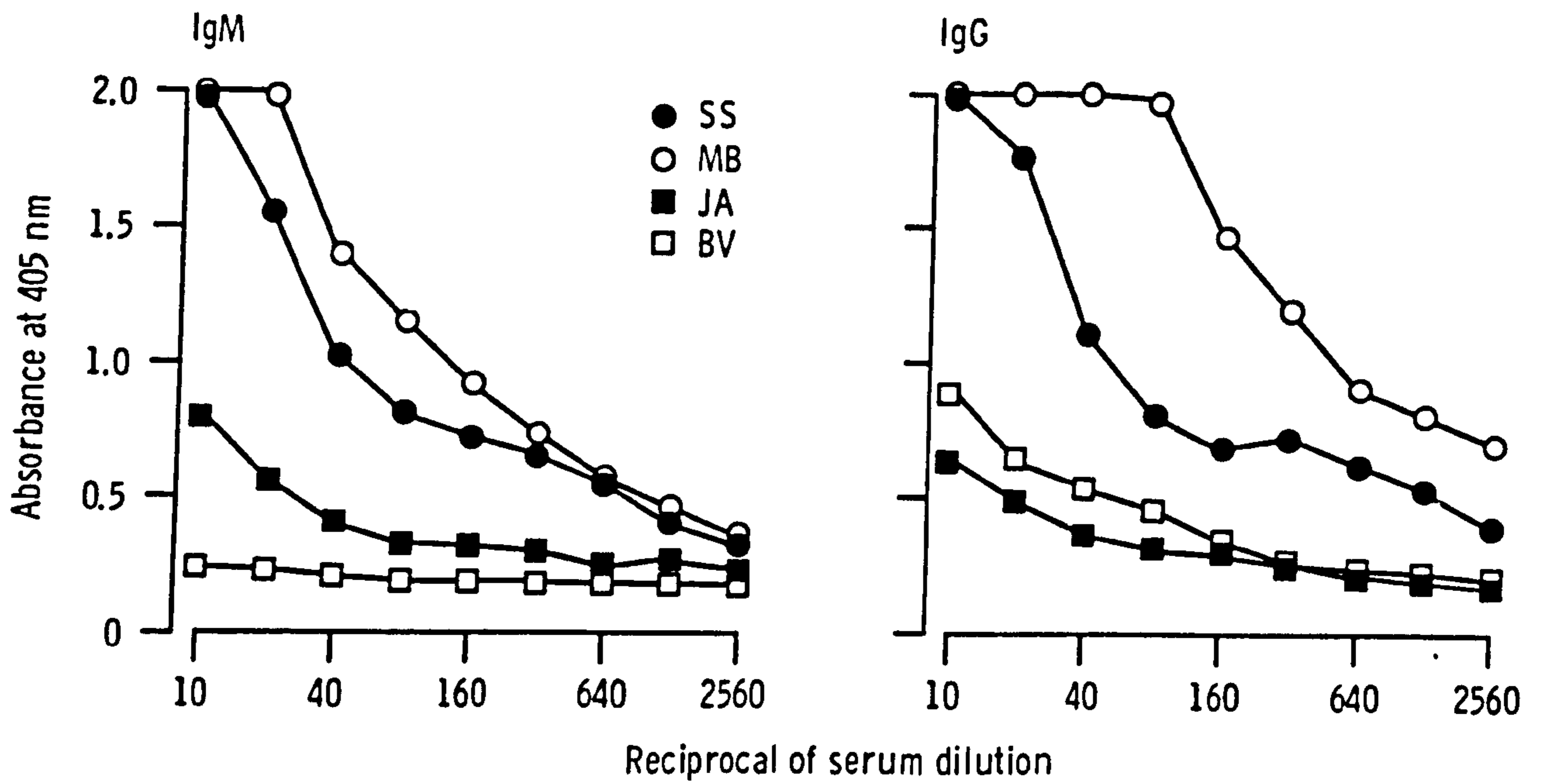
In preliminary experiments, 4 sera (2 adult and 2 infant) were assessed for *E.coli* antibodies by all three techniques. Antibody titration curves by ELISA and RIA, for these sera are shown in Figs 6 - 2, and 6 - 3. Before the availability of the purified standards, difficulties arose in expressing the relative titres of IgG and IgM antibodies as the slopes of the curves were not parallel. In Table 6 - 1 the results are expressed as a percentage of the highest titre serum and compared with the values for the same 4 sera obtained by IHA. Comparison of the three methods shows good correlation between them. The RIA and ELISA techniques have similar sensitivity (although the ELISA test used 5 times as much sample), but the IHA test was far less sensitive (see below).

ii) Quantification of *E.coli* antibodies

The purification and standardisation of an anti-*E.coli* serum, made possible the quantitation of class-specific *E.coli* antibodies. RIA was chosen in preference to ELISA because of the lower volume of serum required for a similar sensitivity. Initial experiments indicated surprisingly high levels of IgG antibodies in the infant sera even

Figure 6 - 2

Titration curve for *E.coli* antibodies by ELISA. Two adult (SS and MB) and two infant sera are shown.



6 - 3

Titration curve for *E.coli* antibodies by RIA.

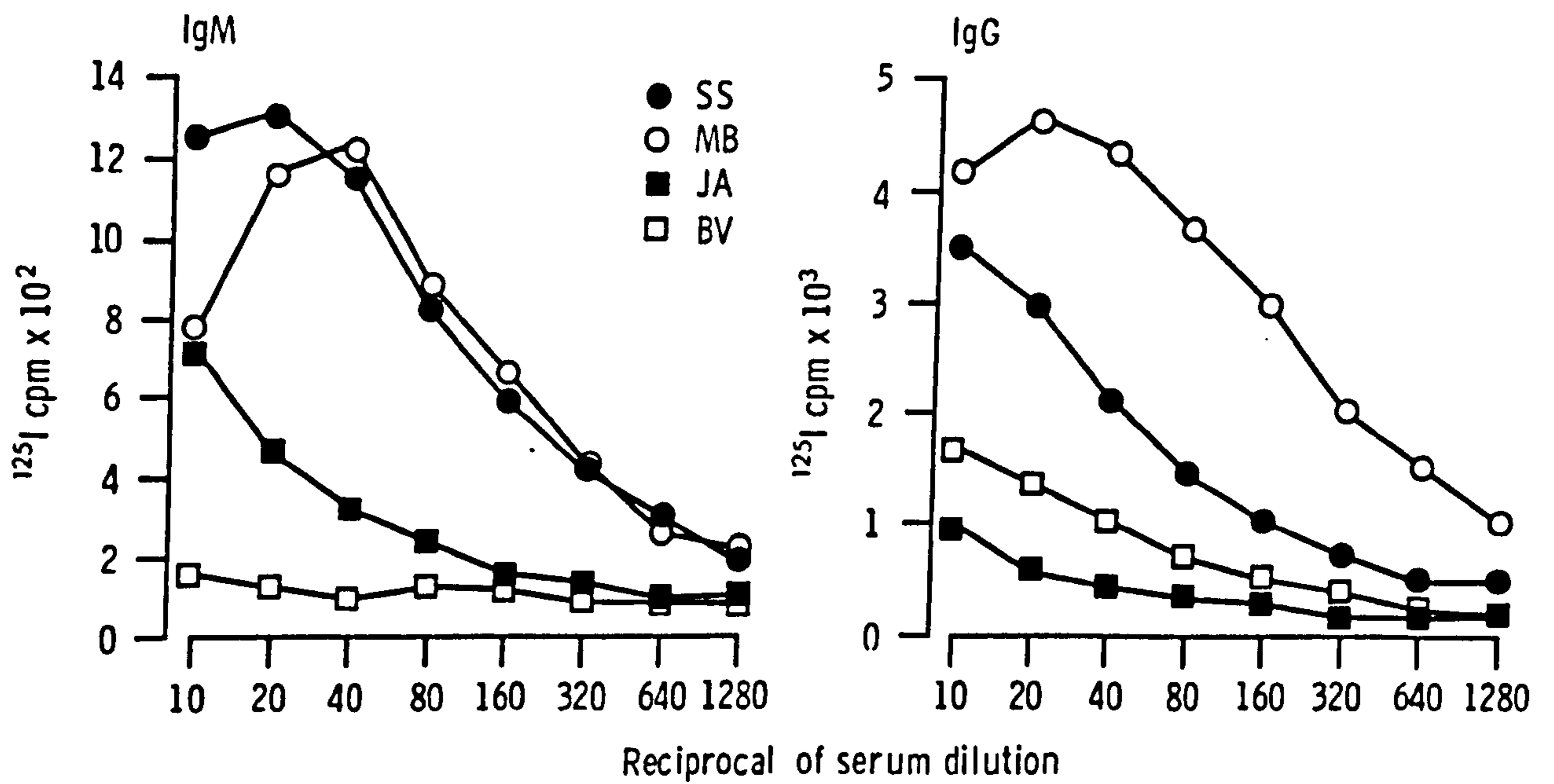


TABLE 6 - 1

COMPARISON OF IHA, ELISA AND RIA TECHNIQUES

DONOR	AGE	IHA		ELISA		RIA	
		2-ME + (M)	2-ME - (G)	IgM	IgG	IgM	IgG
MB	a A	b 256	64	c 100	100	100	100
SS	A	256	4	72	15	85	17
BV	2wk	<2	<2	<0.1	4.3	<0.1	5.4
JA	9m	<2	<2	4.0	0.4	6.5	0.7

a A = Adult

b Reciprocal of titres

c Results expressed as % of positive control (MB),
mean of 3 experiments

though these had negative titres by IHA. It was therefore decided to estimate the sensitivity of IHA for detecting IgG antibodies. Table 6 - 2 shows a comparison of 19 infant and 2 adult sera by the two techniques. Quantitative antibody estimations by RIA indicate that the two normal adults had high levels of IgM ($20\mu\text{g/ml}$) but also had similar quantities of IgG ($5-40\mu\text{g/ml}$) and IgA ($4-25\mu\text{g/ml}$) antibodies against *E.coli*. The 2-ME resistant IHA titres however, (previously thought to indicate IgG and/or IgA antibodies) were considerably lower ($1/8$ and $1/32$ compared with $1/256$ for IgM). The infants had very low levels of specific IgM and IgA in the early neonatal period (15ng/ml or less) confirming the IHA titres ($<1/2-1/10$). Infants at 1 and 6 weeks of age, however, had high levels of IgG antibodies to *E.coli*, up to normal adult levels ($5-10\mu\text{g/ml}$) even though these antibodies were only just detectable by IHA. The older infants had lower IgG antibody levels, which were often undetectable by IHA. Comparison of RIA and IHA techniques therefore shows the minimum sensitivity of IHA for IgG antibodies is about $4\mu\text{g/ml}$ (i.e. 1000-fold less sensitive than RIA). The minimum sensitivity for IgM antibodies by IHA is about $1\mu\text{g/ml}$ which is 4 times higher than for IgG. This discrepancy between IgM and IgG detection is also seen by comparison of sample 20E (IgM $11,000\text{ng/ml}$) and sample 16E (IgG $11,000\text{ng/ml}$), the corresponding IHA titres are $1/256$ and $1/8$ respectively.

3) Total Immunoglobulins in the sera of breast- and bottle-fed infants

The geometric means (+95% C.I.) of IgG, IgM and IgA for the 15 infants in each group on each of the five sample occasions are shown in Fig 6 - 4.

TABLE 6 - 2

COMPARISON OF IHA AND RIA FOR *E. COLI* ANTIBODIES

SAMPLE NUMBER	AGE (WKS)	IgM		IgG		IgA
		RIA	IHA	RIA	IHA	RIA
MB	A*	29000**	256***	39400	64	25500
SS	A	19000	256	5000	4	4000
18A	1	<10	10	8500	<10	<10
12A	1	15	20	6400	20	<5
12B	6	15	10	4200	10	65
05A	1	<5	10	5280	10	<5
05D	26	170	<2	750	<2	10
15B	6	<20	<10	1870	<10	130
20D	26	11000	256	270	2	130
20E	39	10500	256	2400	8	1890
28D	26	5000	64	720	2	100
28E	39	8850	128	5000	8	460
16E	39	4150	128	11000	8	30
22E	39	840	<2	150	<2	30
04E	39	1800	16	125	<2	20
02E	39	4000	64	700	<2	140
11E	39	1140	32	500	<2	10
26E	39	2400	128	6400	<2	120
01E	39	2085	32	500	<2	175
09E	39	2800	64	2050	2	400
13E	39	9350	64	500	<2	65

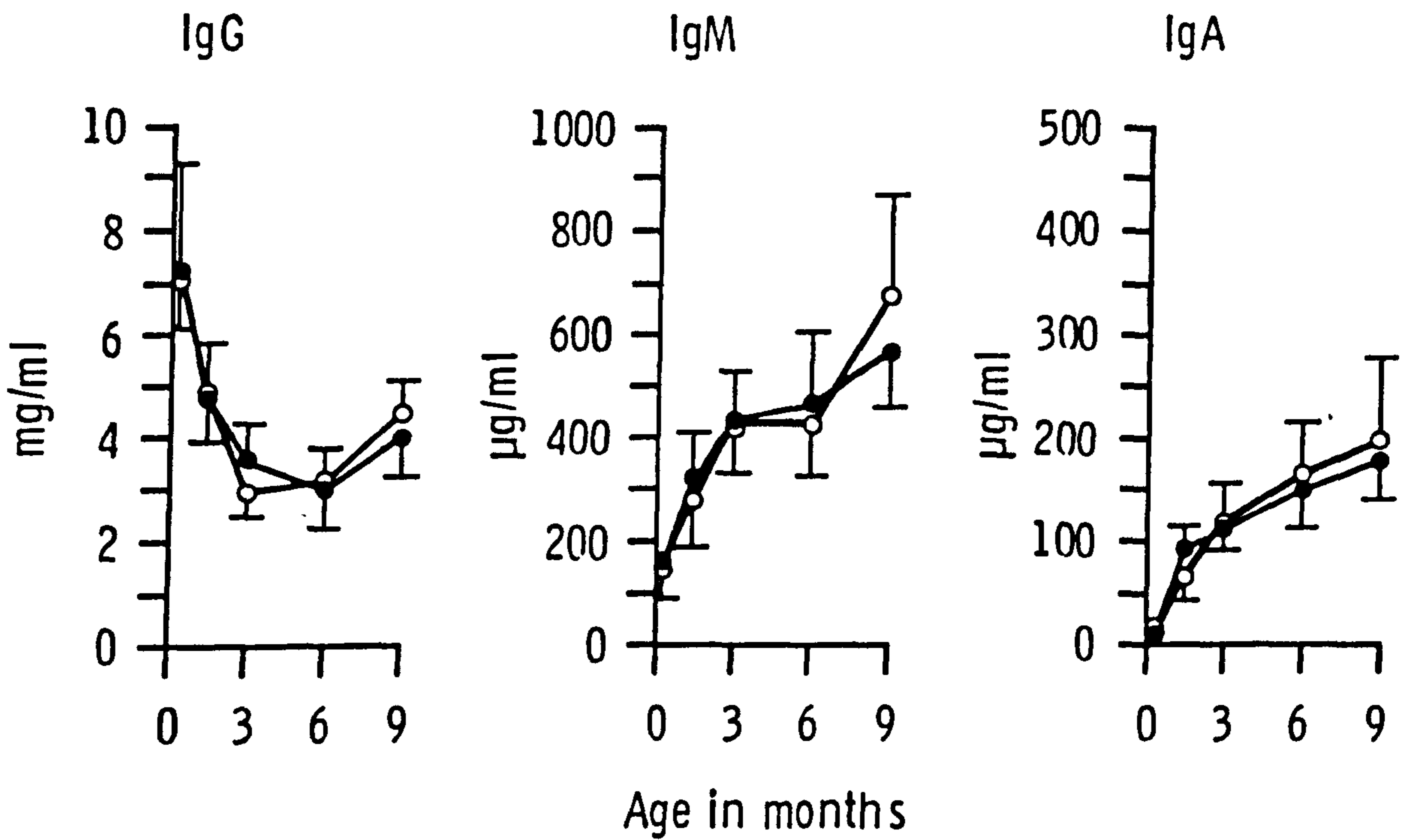
* A = Adult

** Results expressed as ng/ml specific antibody

*** IHA titres expressed as reciprocal of highest dilution showing at least 20% agglutination

Figure 6 - 4

Total immunoglobulin levels in the sera of infants. Geometric means (n=15) \pm 95% C.I. ○ Breast-fed ● Bottle-fed



i) IgG

At 6 days, serum IgG levels were almost as high as adult levels, with a geometric mean of 7mg/ml. The quantity of IgG declined from the 6 day sample until 3-6 months when the mean was 3mg/ml. By 9 months IgG had increased over the 6 month level in all but 4 infants.

ii) IgM

Total IgM levels increased steadily from an average 160 μ g/ml at 6 days to 600 μ g/ml at 9 months, although the range was wide (280-2170 μ g/ml at 9 months).

iii) IgA

All infants had detectable levels of IgA at 6 days, the mean being 1.91 (1.34-2.69) (95% C.I.) and 1.7 (1.29-2.24) μ g/ml in the breast and bottle-fed groups respectively. Although the mean IgA at 6 days was slightly higher in the breast-fed group, this difference was not significant ($P=0.39$). IgA rose rapidly to 80 (43-115) μ g/ml at 6 weeks of age and to 190 (140-275) μ g/ml by 9 months. There was a significant correlation in the IgM and IgA levels of the infants of both groups, ($r=0.768$, $P<0.001$), and this was highest from 6 weeks onwards.

The results for total immunoglobulins of all three classes in the sera of all infants fell within the normal limits for infants, published by other workers, as shown in Table 6 - 3. There were no significant differences in ranges or mean values between the two feeding groups for the three Ig classes on any sample occasion.

TABLE 6 - 3

TOTAL IMMUNOGLOBULINS IN THE SERA OF BREAST- AND BOTTLE-FED INFANTS
COMPARED WITH NORMAL RANGES

		AGE				
		1 WEEK	6 WEEKS	3 MONTHS	6 MONTHS	9 MONTHS
IgG (mg/ml)						
BREAST-	7.24*	4.78	2.92	3.09	4.40	
	(4.7-12.1)	(2.6-8.3)	(1.6-6.0)	(1.8-5.3)	(2.9-6.8)	
BOTTLE-	7.26	4.71	3.52	2.98	3.99	
	(4.7-12.3)	(2.8-8.8)	(2.5-6.5)	(1.2-6.7)	(2.0-7.7)	
NORMAL**	10.04	3.65	3.81	4.88		
	(5.98-16.72)	(2.18-6.1)	(2.28-6.36)	(2.92-8.16)		
IgM (µg/ml)						
BREAST-	138	282	427	427	676	
	(30-660)	(100-1100)	(160-870)	(160-870)	(160-2100)	
BOTTLE-	138	309	427	468	562	
	(55-220)	(110-660)	(170-830)	(210-1500)	(240-1340)	
NORMAL	90	240	380	470		
	(60-150)	(110-510)	(20-600)	(180-1240)		
IgA (µg/ml)						
BREAST-	1.91	69.2	115	166	195	
	(0.45-6.1)	(22-230)	(30-200)	(76-270)	(90-76)	
BOTTLE-	1.7	91	112	148	178	
	(0.5-3.65)	(40-200)	(45-230)	(80-330)	(95-385)	
NORMAL	<50	160	220	440		

* Figures are geometric means with ranges in parentheses

** Normal Ranges from Nathan, D.G. and Oski, F.A. (Eds) 1981

4) Tetanus toxoid antibodies

1) General response

The precise timing of vaccination varied considerably within and between the groups and this had a significant effect on the antibody levels at 6 and 9 months. The infants were therefore allocated to vaccine groups for analysis of the results, as shown in Chapter 3 (Table 3 - 8). The five vaccine groups were :-

I - 1 dose only

II - 1 dose between 3-6 months, 2nd dose between 6-9 months

III - 2 doses between 3-6 months

IV - 2 doses between 6-9 months

V - 3 doses between 3-9 months

Infants receiving DT and DTP vaccine were analysed together as there were no detectable differences in the magnitude of their responses. The only vaccine groups with sufficient numbers to compare responses between feeding groups, were vaccine groups II and III. Since the two infants (05 and 31) in group V receiving three doses of vaccine during the study period did not appear to differ in their responses from those receiving only two doses, they were included in groups II and III for analysis. The IgG and IgM responses of the individual infants in groups II and III to tetanus toxoid are shown in Figs 6 - 5 and 6 respectively. The means of these and the IgA results are shown in Table 6 - 4.

a) IgG anti-TT

All infants responded to one or two doses of vaccine with production of large quantities of specific IgG antibodies. The increases following the second dose were up to 10,000-times the prevaccination

level, resulting in as much as 100 μ g/ml specific antibody. This increase was not affected by the presence of maternal antibodies specific for tetanus toxoid; comparison of the responses in infants with more than 500ng/ml of maternally acquired IgG anti-TT (mean 1230ng/ml, n=8), with those having less than this amount (mean 46ng/ml, n=13), showed no significant difference between the maximal amount of IgG antibodies produced (P=0.46). In addition the maximal IgG antibody level was unaffected by the timing of the vaccinations, i.e. group II or group III. The age at which this maximal response occurred (6 or 9 months) was, however, affected by the vaccination timing, causing significant differences between the vaccine groups (P=0.016). Since there were unequal numbers of breast- and bottle-fed infants in each group, these results could not be pooled for analysis.

b) IgM anti-TT

Not all infants responded to a single dose of vaccine with an increase in specific IgM, but increases in IgM antibodies occurred in all infants following their second dose of vaccine. The maximal specific IgM response was, however, considerably lower than the specific IgG response, with only an average 10-fold increase, resulting in a maximum of 1 μ g/ml (compared with 100 μ g/ml IgG). This compared with a 2-fold increase in total IgM over the same time period (3-9 months).

c) IgA anti-TT

Specific IgA antibodies were found in only a few infants, and the levels were low. Only one infant had IgA antibodies above 100ng/ml (infant 15 at 6 months, 1300ng/ml).

Figure 6 - 5

IgG and IgM anti-TT antibodies in the sera of breast- and bottle-fed infants. Each line represents the average of duplicate assays on individual infants. Matching symbols for G and M antibodies represent the same infant.

Vaccine group II - see text for details

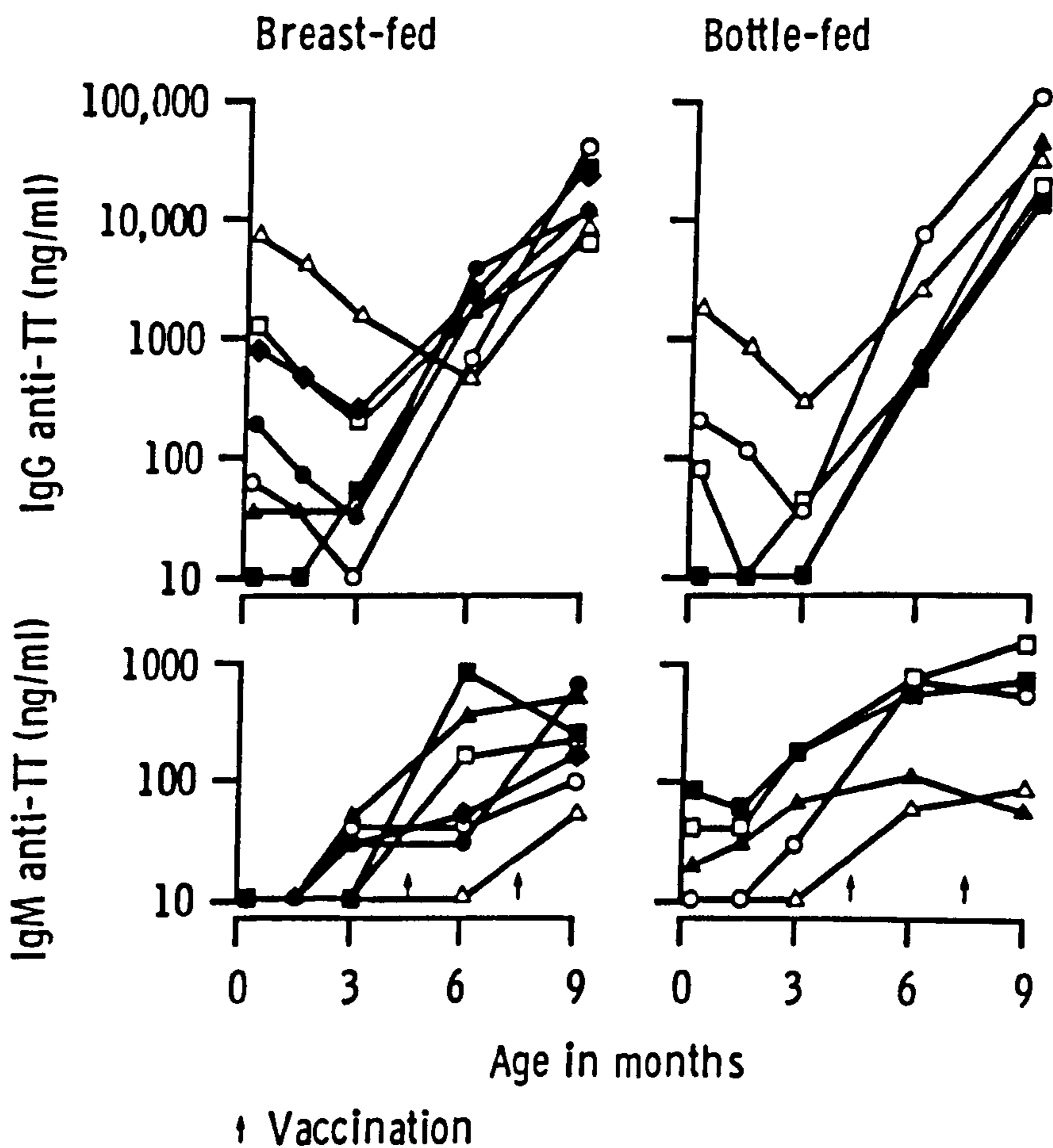


Figure 6 - 6

IgG and IgM anti-TT antibodies in the sera of breast- and bottle-fed infants. Each line represents the average of duplicate assays on individual infants. Matching symbols for G and M antibodies represent the same infant.

Vaccine group III - see text for details

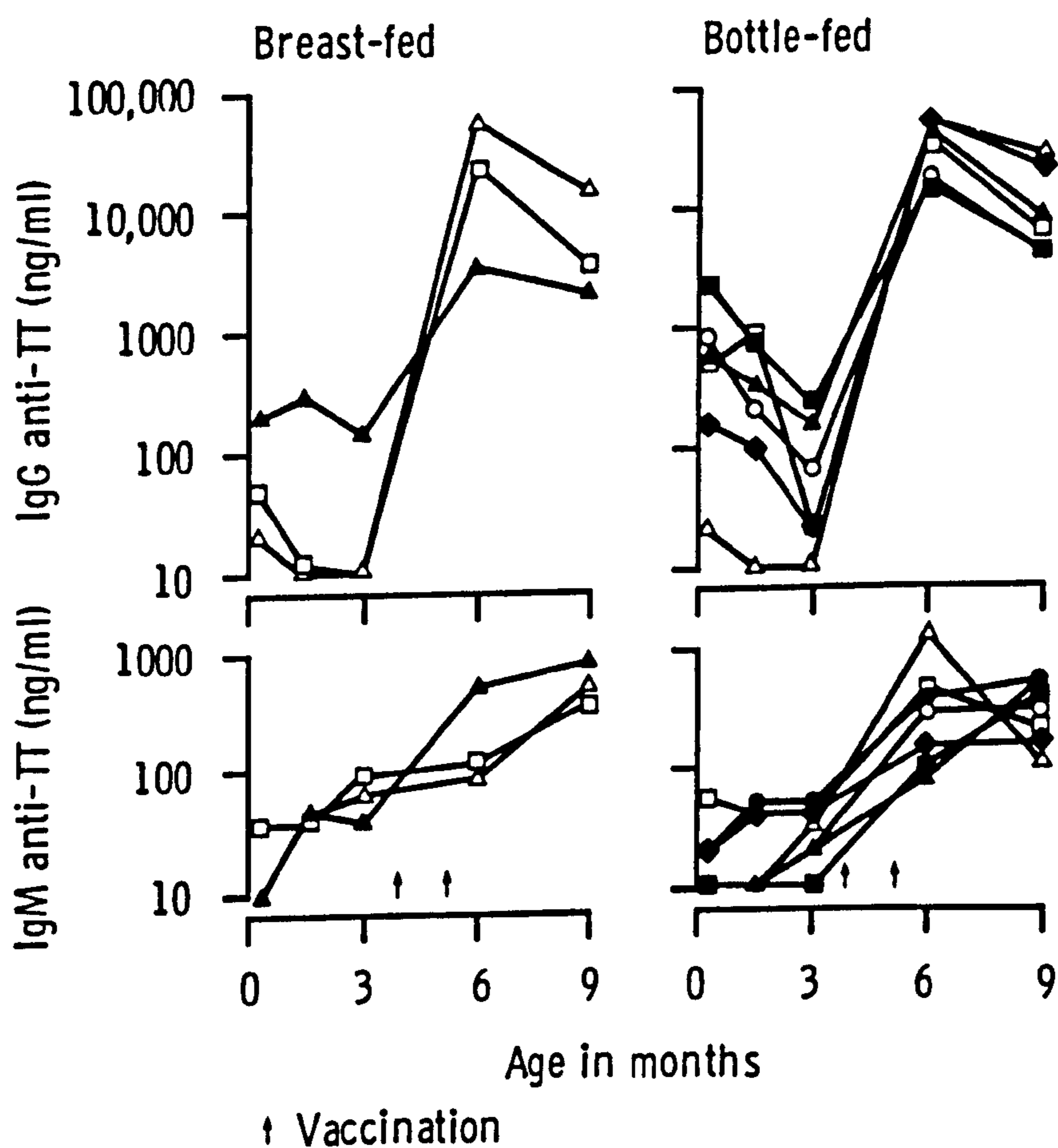


TABLE 6 - 4

Antibody Responses of Breast- and Bottle-fed Infants to Two Doses of Tetanus Toxoid Vaccine

VACCINE GROUP ^a	FEEDING GROUP	NO. INFANTS	AGE				
			1 WK	6 WK	3 MTH	6 MTH	9 MTH
IgG							
II	Breast	7	^b 224	135	85	1,445	15,136
	Bottle	5	78	40	31	1,288	33,884
III	Breast	3	59	3	24	15,850	4,570
	Bottle	6	460	250	59	19,050	4,470
IgM							
II	Breast	7	10	10	18	68	209
	Bottle	5	23	23	60	295	324
III	Breast	3	16	45	66	182	560
	Bottle	7	15	19	27	257	263
IgA							
II	Breast	7	<10	<10	<10	12	14
	Bottle	5	<10	<10	<10	12	17
III	Breast	3	<10	<10	<10	25	21
	Bottle	7	<10	<10	<10	39	24

a See text for vaccination details

b Results are geometric means of data shown in Figs. 6 - 5 and 6 - 6, expressed as ng/ml of specific antibody

ii) Comparison of breast- and bottle-fed infants

There were no significant differences between breast- and bottle-fed infants in both vaccine groups, either in the rate or magnitude of the specific IgG, IgM or IgA anti-tetanus toxoid responses. The slightly lower means of IgM levels of the breast-fed infants in vaccine group II at 6mths (Table 6 - 4) resulted from the failure of two infants to show an IgM response at this time (i.e. after only one dose, Fig. 6 - 5); the difference was not significant ($P=0.07$).

5) Antibodies to *E.coli* 'O' antigens

The geometric means for IgG-, IgM- and IgA- *E.coli* antibodies are shown in Fig. 6 - 7.

i) IgG anti-*E.coli*

All infants had high levels of IgG antibodies to commensal *E.coli* antigens at 6 days (range 700-14,000ng/ml), which declined at a similar rate to the total IgG levels over the first 3 months. There were no significant differences between the levels in breast- and bottle-fed groups at any age, although the bottle-fed group showed a slight increase in specific IgG at 9 months which was not found in the breast-fed group ($P=0.12$).

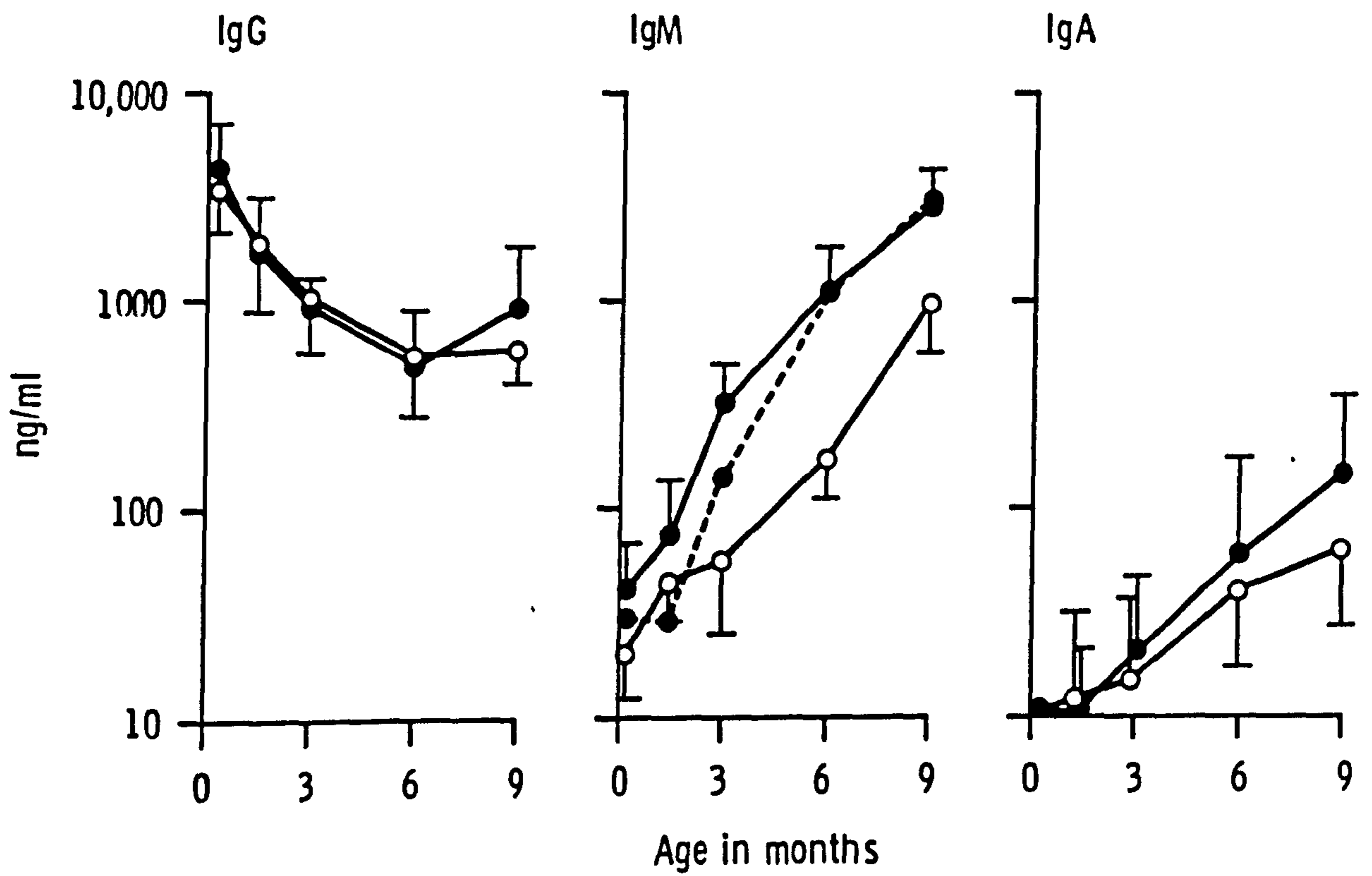
ii) IgM anti-*E.coli*

In contrast to the similarity of IgG anti-*E.coli* antibodies, there were highly significant differences between the breast- and bottle-fed groups in the quantity of IgM antibodies ($P<0.0001$) with higher levels in the bottle-fed infants. This difference was apparent as early as 6 days when only 2/15 breast-fed infants had detectable antibody compared with 7/15 in the bottle-fed group. The differences in the quantities of IgM antibodies were greatest at 3 and 6 months when

Figure 6 - 7

E.coli antibodies in infant sera.

○—○ Breast-fed >7 months (n=12); ●--● Breast-fed <2 months (n=3);
 ●—● Bottle-fed (n=15); Geometric means \pm 95% C.I.



there was very little overlap in the range of antibodies between the two groups (<10-150ng/ml in the breast-fed infants compared with 80-1110ng/ml in the bottle-fed infants at 3 months). The three breast-fed infants who were weaned before 3 months, were analysed separately (Fig 6 - 7). Each produced IgM anti-*E.coli* antibodies at levels similar to the breast-fed infants up to 6 weeks, but by 6 months had antibody levels as high as the bottle-fed infants. The rate of increase of IgM anti-*E.coli* antibodies in bottle-fed infants was far greater than the rate of increase of IgM anti-tetanus toxoid and of total IgM, as can be seen from comparison of Figures 6 - 4 to 7.

ii) IgA anti-*E.coli*

There was also a greater increase in IgA antibodies to *E.coli* in the bottle-fed group, but there was wide variation within the groups and the difference was not significant ($P=0.17$ at 9 months). The three breast-fed infants weaned early, again had IgA anti-*E.coli* antibodies similar to those found in bottle-fed infants.

SECTION D - DISCUSSION

1) Total immunoglobulins

There have been many studies of human infants to determine whether the large quantities of secretory IgA and other immunoglobulins in breast milk are absorbed by the neonate. Results from these studies have been conflicting, with reports that both IgG (Yengar and Selvaraj, 1972), and IgA (Ogra, Weintraub and Ogra, 1977) were absorbed by breast-fed infants, that there was no difference

between the groups (Ammann and Stiehm, 1966; Kletter *et al.*, 1971; Yap *et al.*, 1979) and that there was increased IgA in bottle-fed infants (Saarinen, Pelkonen and Siimes, 1979; Savilahti, Jarvenpaa and Raiha, 1983). Many of the earlier studies used insensitive techniques which failed to detect the small amounts of IgA present in the sera of newborn infants. The results from the present study indicate that all full-term healthy infants tested had detectable IgA in their serum by 6 days of age, and extend the findings of Kletter *et al.*, (1971) who showed no differences in levels of IgG, IgM or IgA in the sera of breast- and bottle-fed infants on any occasion up to 7 months. This study indicates a wide range of immunoglobulin levels in the sera of infants at each sample occasion from 1 week to 9 months, but all levels fell within the normal ranges, and there were no differences in the ranges or the mean values for any class of immunoglobulin on any sample occasion between the two feeding groups. The study included one breast-fed atopic infant. This infant had serum IgA at about the 5% confidence level from 6 weeks of age ($45\mu\text{g/ml}$, to $100\mu\text{g/ml}$ at 9 months) although levels at 6 days were higher than average ($3.4\mu\text{g/ml}$). Soothill and colleagues (Taylor *et al.*, 1973) have suggested that atopy in infants is due to a transient IgA deficiency in early infancy and this infant could fall into this category. However there were other infants in this study who had even lower IgA levels, yet showed no signs of allergic disease.

These results on serum IgA levels indicate that either milk immunoglobulins are not absorbed in significant quantities, or that if any of the IgA in breast milk is absorbed, it is cleared rapidly from the blood. Peppard *et al.*, (1981) have shown in rats that dimeric IgA injected intravenously is cleared rapidly via the hepatic cells into

the bile. This mechanism is thought to be mediated by receptors on the hepatic cells, which have been identified as secretory component molecules. Such a mechanism has yet to be demonstrated in the human, but is unlikely to operate for sIgA, which already has a molecule of secretory component attached.

2) Specific antibody responses

i) Responses to tetanus toxoid vaccination

Quantification of antibody responses to tetanus toxoid has shown that all infants studied responded to two doses of toxoid with an average 400-fold increase in specific IgG. The rate of response was affected by the time interval between vaccine doses, but the maximal response was similar in all infants regardless of the timing of the doses, or the quantity of maternally acquired IgG anti-TT present. IgM responses did not always occur after a single vaccine dose, but all infants showed an increase in specific IgM after their second dose. This was of a low magnitude (average 4-fold increase) compared with the IgG response. This is similar to the responses in adults to a booster dose of tetanus toxoid (Brenner, 1981). As would be expected from a systemically administered antigen, serum IgA responses to tetanus toxoid were low or undetectable. For all three classes of immunoglobulin, there were no significant differences between the responses of breast- and bottle-fed infants to tetanus toxoid. This is in agreement with the findings of Zoppi *et al.* (1983) who showed a similar total specific antibody response to tetanus toxoid, diphtheria toxoid and pertussis vaccination in breast-fed infants and those fed cow milk formulae with a high protein content (although those fed low protein formulae showed a reduced response with a more rapid decline

of the antibodies produced). This similarity in the antibody response of breast- and bottle-fed infants suggests that their capacity to respond to a systemically administered protein antigen develops at a comparable rate.

ii) Responses to normal gut flora

a) Disparity between IHA and RIA

Quantification of *E.coli* antibodies by RIA has shown that specific IgG anti-*E.coli* antibodies at 6 days were high in both breast- and bottle-fed infants (up to adult levels). Previous measurements (Neter *et al.*, 1955) indicated low or undetectable antibodies to *E.coli*. However these studies had used indirect haemagglutination (IHA), a technique known to favour the detection of IgM antibodies and to be relatively insensitive for IgG detection (Ahlstedt *et al.*, 1975). Comparison of the RIA and IHA techniques in this study has shown that the limit of detection for IgG anti-*E.coli* antibodies by IHA is about 4,000ng/ml. Indeed many of the sera collected at 6 days which had high IgG but undetectable IgM *E.coli* antibodies by RIA, had titres of 1/4 or less by IHA, indicating how misleading IHA can be in assessing antibody levels in neonates.

b) Differences in responses to gut antigens

In contrast to the similar responses of breast- and bottle-fed infants to a systemically administered protein antigen, responses to an antigen encountered in the gut indicated major differences between the two feeding groups, particularly in the IgM and IgA classes of antibodies. First, although the IgG *E.coli* antibody levels were similar in breast- and bottle-fed infants up to 6 months, more of the bottle-fed infants showed an increase from 6-9 months than the

breast-fed infants.

Second, although the IgM anti-*E.coli* response showed a rapid rate of increase in both groups, with up to a 1000-fold increase in specific IgM, there was a significantly greater increase in IgM anti-*E.coli* antibodies in the bottle-fed group, as early as 6 days. This higher level was maintained and was maximal by 3-6 months ($P < 0.001$).

3) Reduced systemic exposure to gut antigens in breast-fed infants.

As total immunoglobulin levels and the specific antibody response to tetanus toxoid suggest that immune potential is similar in the two feeding groups, then the differences in antibody levels to *E.coli* indicates a difference in systemic exposure rates to these organisms. The neonatal gut is known to be more permeable than the adult gut to macromolecules (Chandra, 1979), and there are several reasons why the bottle-fed infants could have a higher rate of systemic exposure to *E.coli* antigens from the gut than breast-fed infants.

i) Normal gut flora

Some studies have indicated that there may be greater numbers of *E.coli* in the gut of the bottle-fed infants. It has been shown that the lower buffering capacity of human milk, together with the presence of a factor which encourages the growth of Lactobacilli, produces a more acidic environment in the gut of breast-fed infants which discourages the growth of coliform organisms (Bullen, 1981). Examination of the stools of breast- and bottle-fed infants has shown a higher number of coliforms in the stools of bottle-fed infants (Bullen and Willis, 1971). The balance of normal gut flora has also

been shown to be important in mice in limiting translocation of *E.coli* from the gut to the mesenteric lymph nodes (Berg 1980), so the higher numbers of Lactobacilli found in the stools of breast-fed infants could be helping to limit translocation of *E.coli* in these infants.

ii) Milk antibodies

Human milk contains large quantities of sIgA antibodies and many of these antibodies are directed against organisms colonising the mothers' gut, including *E.coli* (Goldman and Smith, 1973). These antibodies can be shown *in vitro* to have anti-adhesive properties (Williams and Gibbons, 1972), and are thought to have an important role *in vivo* in preventing gastrointestinal passage of gut antigens (Skogh, Edebo and Stendhal, 1983).

iii) Foreign protein

Another possible reason for the increased serum antibodies in the bottle-fed infants could be an adverse reaction to cow-milk protein. Large amounts of cow milk protein antigens can be shown to cross the neonatal gut wall and stimulate production of serum and secretory antibodies (Kletter *et al*, 1971; Eastham and Walker, 1977, 1979). This immune reaction may cause inflammation and thus further increase the permeability of the gut to macromolecules.

iii) Epithelial growth factors

Human milk also contains factors which stimulate maturation of gut epithelium *in vitro* and perhaps accelerate maturation of an intact mucosal barrier (Walker, 1977). Breast-fed rabbits have been shown to have a lower uptake of orally administered bovine serum albumin, which was not due to anti-BSA antibodies in the milk, and was again attributed to increased maturation of gut epithelial cells (Udall *et*

et al., 1981). This enhanced maturation may prevent passage of *E.coli* antigens across the gut wall in breast-fed human infants.

4) Overall similarity of sera from breast- and bottle-fed infants

This comparison of serum antibody responses of breast- and bottle-fed infants has not indicated whether breast milk provides factors - lacking in cow milk formulae - which stimulate the maturation of the immune system. Even if such factors were present, their action may be masked, for the bottle-fed infant undoubtedly receives greater stimulation to its immune system in the form of increased antigenic challenge from gut antigens. This increased antigenic challenge may itself cause endogenous release of growth factors which may act on cells of the immune system and stimulate them to mature. Endotoxins from gut bacteria are known to be mitogenic *in vitro*, particularly for B cells, and have been shown to enhance specific antibody production *in vivo* in mice (Lagrange *et al.*, 1975a and b) and in humans (Rethy, 1983). In Germany, an oral vaccine consisting of live *E.coli* and *Strep.faecalis* has been administered to humans and animals for the last 20 years in the therapy of chronic and recurrent infections, not only of the gut, but also of the respiratory tract and for allergies. The mechanism of action is not fully understood, but recent animal work suggests a non-specific stimulation of the immune system (Rusch, Hyde and Luckey, 1983). If bottle-fed infants are receiving immunological stimuli in the form of increased antigenic challenge and increased absorption of gut endotoxins, then the similarities in total immunoglobulin levels and responses to tetanus toxoid suggest that the breast-fed infants may be receiving a similar stimulus from growth factors in milk. There is evidence that

human colostrum and milk cells can secrete growth factors (epidermal growth factor) and lymphokines (including lymphocyte-derived chemotactic factor, γ -interferon, and prostaglandins E and F) *in vitro* which are capable of stimulating lymphocytes to mature (Goldman, 1977; Keller *et al.*, 1981; Blau *et al.*, 1983).

This overall similarity in the capacity to produce systemic antibodies may therefore obfuscate the different ways by which the immune system is stimulated to mature in breast- and bottle-fed infants. The difference in mechanism is of more than theoretical interest. Stimulation by normal gut flora may not constitute a great hazard in developed countries such as the U.K. which are relatively free from disease, but could cause severe problems in countries where enteropathogenic disease is hyperendemic.

SUMMARY

The effects of breast- and bottle-feeding on serum immunoglobulin levels and specific antibody responses in infants have been examined. No significant differences were found between the two feeding groups in total immunoglobulin levels of G, M and A classes on any sample occasion. All infants responded to two doses of a systemically administered tetanus toxoid vaccine with production of large quantities of specific IgG antibodies, regardless of the initial level of (maternally derived) anti-tetanus toxoid IgG. Again there were no significant differences between the breast- and bottle-fed infants, suggesting that the capacity of the two groups to make serum antibodies develops similarly. Concentrations of antibodies to commensal *E.coli* lipopolysaccharide (LPS) antigens were significantly

greater in the bottle-fed group, and it is suggested that this difference is due to an increase in the exposure of the systemic immune system to these gut antigens in the bottle-fed infants. There are several possible explanations for this increased exposure and the resulting effects on the infants' immune system.

CHAPTER 7

IN VIVO STUDIES ON SECRETIONS

SECTION A - INTRODUCTION

The lack of antigenic stimulation *in utero* means that the secretory immune system is functionally immature at birth. This results in very low levels of immunoglobulins in secretions. In order to determine the effects of breast-feeding on the development of this system, it was necessary to choose a secretion which was easy to obtain in sufficient quantities, without causing inconvenience to the infants or mothers. Saliva is the simplest secretion to collect in infants, but has the disadvantage that it is impossible to obtain samples from breast-fed infants which are not contaminated with the immunoglobulins from milk. Roberts and Freed (1977) considered that the higher concentration of IgA in the saliva of 6 day old breast-fed infants was due to an active stimulation by factors in human milk. However, Gross and Buckley (1980) suggested that contamination by IgA from milk was a more likely explanation. The latter workers found no differences between breast- and bottle-fed infants when samples were collected at least 4 hours after the last feed. For the present study, although mothers were requested not to feed their infants for at least 2 hours before sample collection, it was felt unethical to withhold food for up to 4 hours if the infants were obviously hungry. Monoclonal antibodies to allotypic markers, which could distinguish between maternal and infant IgA, were not available. The IgA measured in the saliva of breast-fed infants prior to weaning, could therefore be of either maternal or infant origin. However, since this study continued beyond the weaning period for many of the breast-fed

infants, and since the IgA in the saliva of the bottle-fed infants will be totally derived from the infant, it was felt that the study of salivary immunoglobulins might indicate differences between the two groups.

SECTION B - METHODS

1) Processing of saliva samples.

Undiluted saliva samples, or saliva samples washed from the catheter with 200 μ l PBS (see Chapter 2) were homogenised by forcing frozen/thawed samples repeatedly through a fine bore pasteur pipette. Sonication in a sonicating water bath was also tried but this did not improve homogenisation and had the disadvantage of causing a considerable rise in temperature. Other workers have used centrifugation or passage through a millipore filter to remove debris but this was considered unsatisfactory since there would also be an inevitable loss of immunoglobulins, which might be attached to cells or mucins.

All samples were tested for contamination with blood, by using Hemastix (Ames Reagent strips, Miles Laboratories Ltd.) and all were negative.

2) Total protein estimations

Total protein assays were carried out on all saliva samples. Immunoglobulins were expressed as μ g/mg protein; where sufficient sample was available (6 weeks to 9 month samples only) immunoglobulins were also expressed as μ g/ml undiluted saliva. A protein-dye binding

microassay was used (Bradford, 1976). This technique involves the binding of Coomassie Brilliant Blue dye to protein, which causes a shift in the absorption maximum of the dye from 465 to 595nm. The bovine gamma globulin (BGG) standard (Bio-Rad) was diluted in PBS to give a range of concentrations (usually six) between 1 and 25 μ g/ml. Samples were diluted to give protein concentrations within this range (a 1:1000 dilution was found to be appropriate). Standards or samples were dispensed in 1ml volumes in 1/2 inch test-tubes and 250 μ l of Bio-Rad dye reagent concentrate (containing Coomassie Brilliant Blue G-250, phosphoric acid and methanol) was added. Samples were mixed thoroughly on a vortex mixer (Hook and Tucker Instruments Ltd.) and absorbance was measured between 5-60 minutes at 595nm on a spectrophotometer (Perkin-Elmer, Model 6/20). The absorbance of the standards was plotted against protein concentration (as shown in Fig 7 - 1) and the concentrations of the samples were read from this curve.

3) Radioimmunoassay for immunoglobulins.

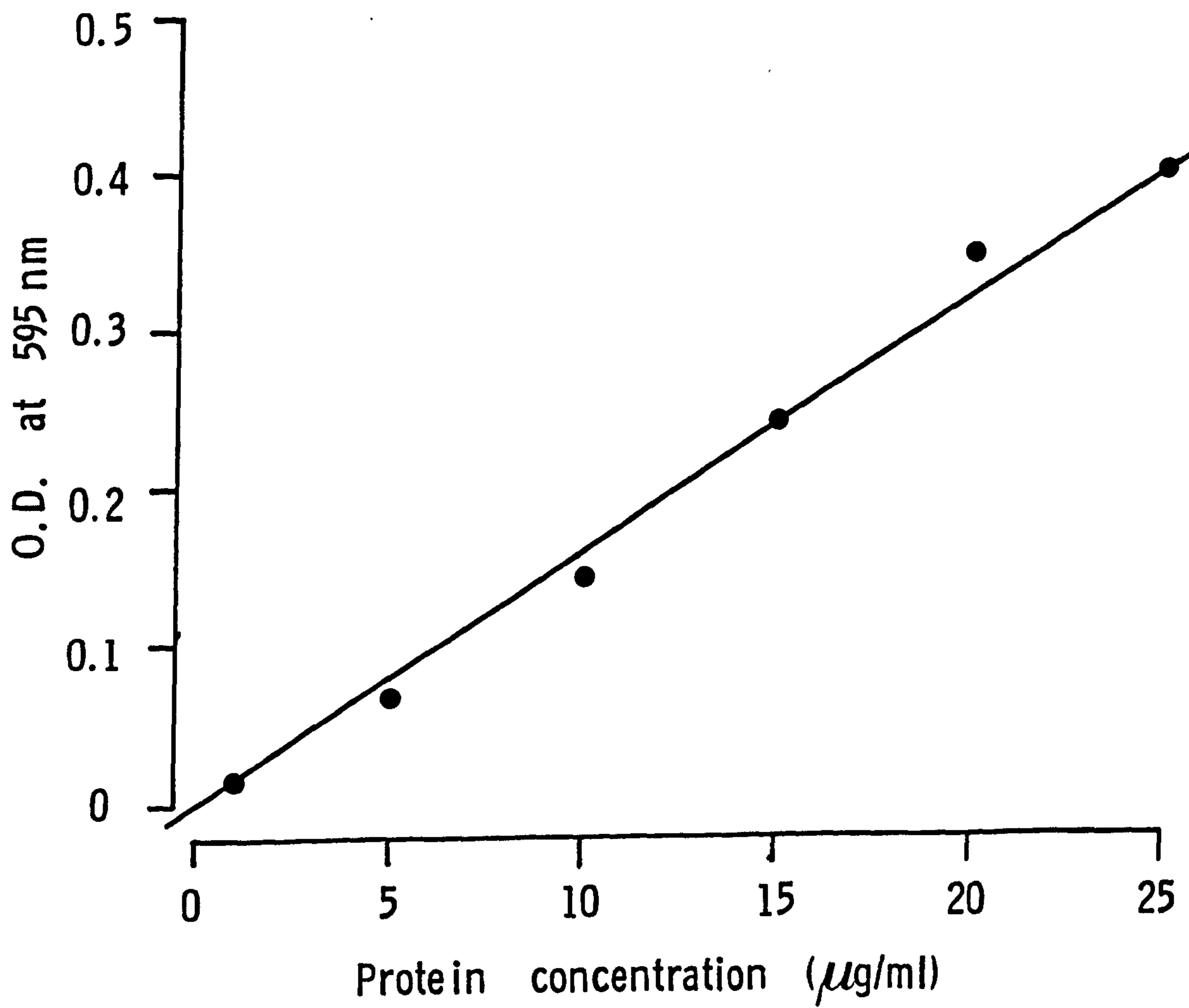
This assay has been described in Chapter 2. Saliva samples were initially diluted 1/5, followed by eight serial 4-fold dilutions in blocking buffer. The minimal sensitivity of this assay for detecting immunoglobulins in secretions was IgG 0.01 μ g/ml, IgM 0.02 μ g/ml and IgA 0.02 μ g/ml.

4) Statistics

Immunoglobulin concentrations were log-transformed to normalise the distribution. Differences in immunoglobulin and total protein concentrations between feeding groups were assessed by the pooled t-test.

Figure 7 - 1

Standard curve for estimating total protein concentrations in saliva samples. A standard curve using bovine γ -globulin was included in each assay.



SECTION C - RESULTS

1) Total immunoglobulin levels in undiluted saliva.

On no occasion was sufficient saliva obtained from a 6 day old infant to make an initial measured dilution, however from 6 weeks, satisfactory samples were obtainable from most infants. Figure 7 - 2 shows the geometric means (\pm 95% C.I.) of IgG, IgM and IgA concentrations. These means and the ranges are shown in Table 7 - 1.

i) IgG

At 6 weeks, the mean concentration of IgG in saliva was $1\mu\text{g/ml}$, about 0.02% of the concentration in serum at this time. The level declined until 6 months (average $0.44\mu\text{g/ml}$), but by 9 months had risen in 11/15 breast-fed infants and 12/14 bottle-fed infants. There were no significant differences between the two feeding groups.

ii) IgM

IgM levels rose slightly in both groups between 6 weeks and 9 months. On all occasions IgM was higher in the bottle-fed than the breast-fed group, and this difference was significant at 3, 6 and 9 months ($P=0.017$, 0.022 and 0.04 respectively). In breast-fed infants the concentrations rose from 0.5 to $1\mu\text{g/ml}$ and in bottle-fed infants from 1 to $2\mu\text{g/ml}$. IgM concentrations in saliva were approximately 1% of those in serum.

iii) IgA

Concentrations of IgA in saliva declined slightly from 100 to $25\mu\text{g/ml}$ from 6 weeks to 9 months. IgA levels were up to 100 times the concentration of IgG or IgM. At 6 weeks salivary IgA was comparable with the IgA level in serum (96%) but by 9 months the concentration in

Figure 7 - 2

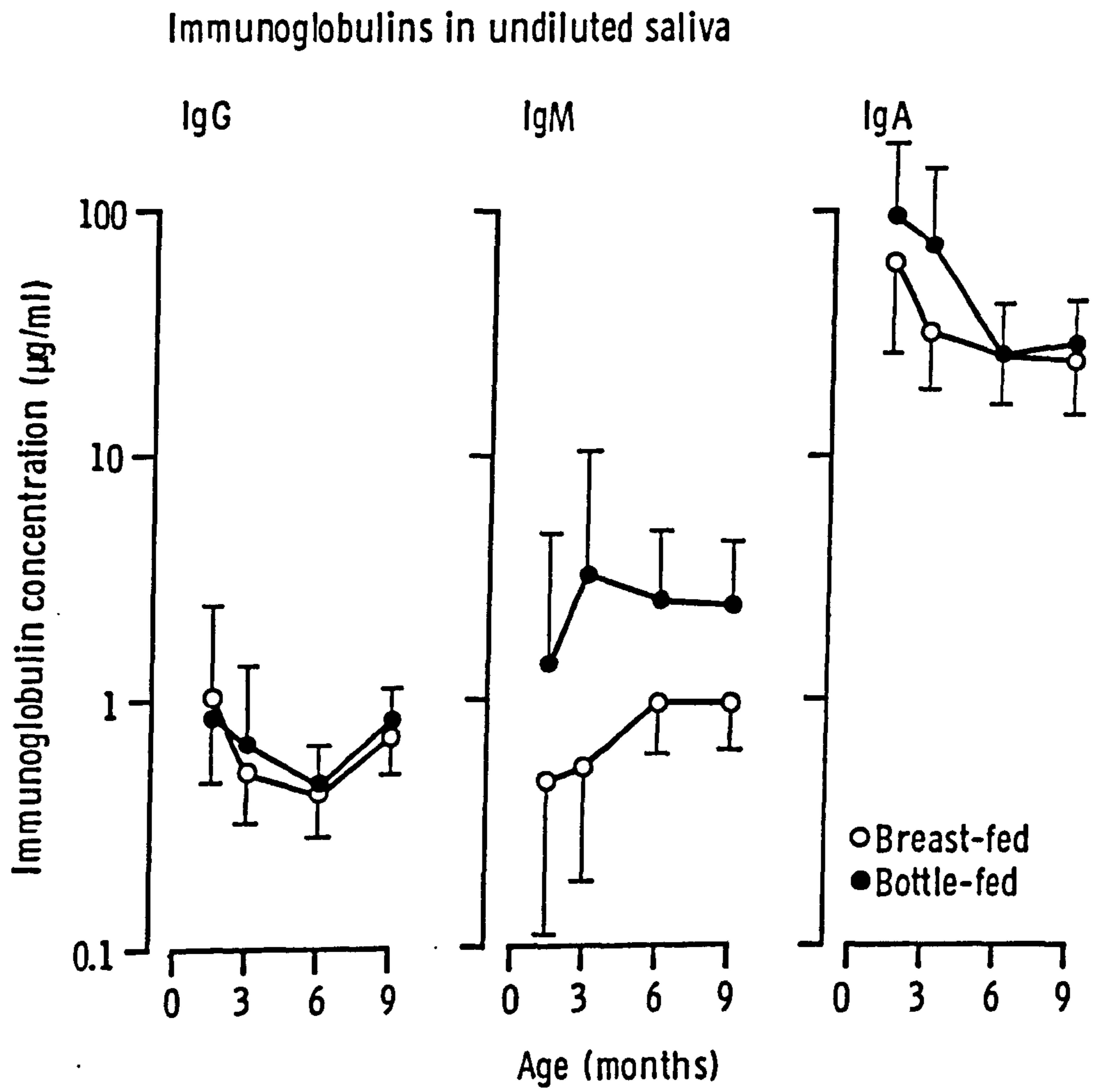


TABLE 7 - 1

IMMUNOGLOBULIN CONCENTRATIONS IN SALIVA

FEEDING GROUP	age-	6 DAYS	6 WKS	3 MTHS	6 MTHS	9 MTHS
IgG						
BREAST	n =	0	10	14	15	15
	MEAN	-	1.05*	0.50	0.42	0.72
	RANGE	-	0.35-8.0	0.12-1.85	0.16-1.8	0.2-1.7
BOTTLE	n =	0	12	14	15	14
	MEAN	-	0.89	0.6	0.45	0.82
	RANGE	-	0.27-4.5	0.09-4.9	0.2-2.2	0.4-1.7
	P		0.74	0.44	0.76	0.9
IgM						
BREAST	MEAN	-	0.47	0.53	1.0	0.96
	RANGE		0.0-9.0	0.04-3.8	0.24-3.	0.35-7.6
BOTTLE	MEAN	-	1.14	3.31	2.51	2.40
	RANGE		0.14-20	0.1-40	0.4-18	0.95-20
	P		0.20	0.017	0.022	0.040
IgA						
BREAST	MEAN	-	61.66	33.11	25.70	24.55
	RANGE		13-485	14-280	6-73	5-135
BOTTLE	MEAN	-	93.33	77.63	26.30	28.84
	RANGE		9-190	19-250	9-130	10-108
	P		0.4	0.048	0.93	0.61

* Immunoglobulin concentrations in $\mu\text{g/ml}$ saliva

TABLE 7 - 2

GEOMETRIC MEANS OF IgA CONCENTRATIONS IN SERUM AND SALIVA FROM
BREAST- AND BOTTLE-FED INFANTS

AGE	6 WK	3M	6M	9M
BREAST-FED				
SERUM	69*	115	166	195
SALIVA	62	33	26	25
PERCENTAGE	90	29	16	13
BOTTLE-FED				
SERUM	91	112	148	178
SALIVA	93	78	26	29
PERCENTAGE	102	70	18	16

* Immunoglobulin concentrations expressed as $\mu\text{g/ml}$

saliva had fallen to 15% of serum IgA (Table 7 - 2). As with salivary IgM, the IgA levels were higher in the bottle-fed group, and this difference was significant at 3 months ($P=0.045$).

2) Total protein estimations

Quantitative measurement of total proteins are shown in Fig 7 - 3. Large variations were found, particularly in the earlier samples. Concentrations in the two feeding groups were similar at 6 weeks, but from 3 to 9 months there was a higher total protein concentration in the bottle-fed group; this difference was significant at 6 and 9 months ($P=0.0025$ and 0.025 respectively).

This difference in total proteins could not be explained by the differences in IgM or IgA concentrations alone. In adult saliva, the enzyme amylase constitutes a high proportion of the protein content. In order to determine whether this enzyme was responsible for the differences in protein content of the two feeding groups, two infant saliva samples (6 month) were selected from each feeding group with high (bottle) or low (breast) total protein content. These samples were assayed for amylase activity in the Haematology Department of NPH using the Phadebas kit (Pharmacia). The results (Table 7 - 3) indicate 3-4 fold higher amylase activity in the saliva samples from the bottle-fed infants.

3) Immunoglobulin concentrations expressed per milligram of protein.

The results of salivary immunoglobulins expressed as $\mu\text{g}/\text{mg}$ of protein showed a similar pattern generally to the concentrations per ml of undiluted saliva, except that the 3 to 9 month samples from bottle-fed infants had a relatively lower concentration due to the

Figure 7 - 3

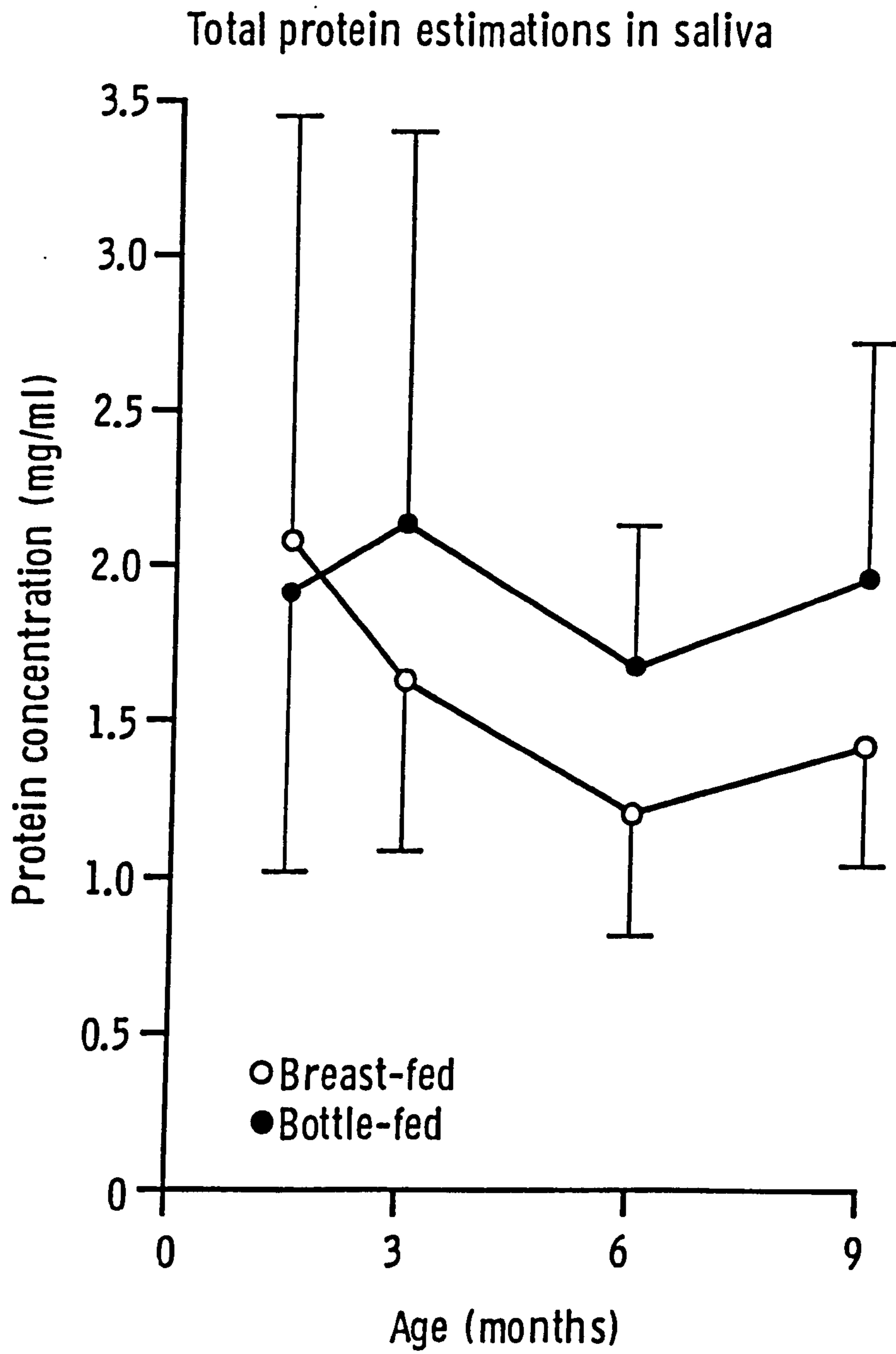


TABLE 7 - 3

PROTEIN CONCENTRATIONS IN SALIVA FROM BREAST- AND BOTTLE-FED INFANTS

SAMPLE NUMBER	FEEDING GROUP	TOTAL PROTEIN (mg/ml)	IMMUNOGLOBULIN (μ g/ml)			AMYLASE (IU/ml)
			G	M	A	
17 D	BREAST	1.04	0.99	0.36	12.0	82,000
27 D	"	1.17	0.36	0.66	19.8	77,000
15 D	BOTTLE	1.84	0.24	1.25	14.0	284,000
28 D	"	2.22	0.21	0.67	9.1	281,000

higher total protein content. Geometric means of these results are shown in Fig 7 - 4 and the ranges are shown in Table 7 - 4.

i) IgG

IgG concentrations in 6 day samples were higher than 6 week samples. The pattern of IgG per mg of protein was otherwise similar to the levels per ml of saliva, and again there were no significant differences between the two feeding groups.

ii) IgM

At 6 days, IgM was undetectable in 8/13 bottle-fed and 3/12 breast-fed infants tested (i.e. $<0.01\mu\text{g}/\text{mg}$ protein). The average concentrations for the two groups at 6 days were $0.10\mu\text{g}/\text{mg}$ (breast) and $0.03\mu\text{g}/\text{mg}$ (bottle). This difference was significant ($P=0.014$). By 6 weeks, there was an enormous rise in the levels of IgM in the saliva of the bottle-fed infants, resulting in 3 to 4 times the concentration of IgM in the saliva of the bottle-fed group than the breast-fed group. This higher level per mg protein remained until 9 months, and was significantly greater than that of the breast-fed group for the 3 month sample ($P=0.015$).

iii) IgA

At 6 days, IgA was undetectable in the saliva of 5 bottle-fed infants ($<0.1\mu\text{g}/\text{mg}$), but was detectable in all breast-fed infants, with levels up to $50\mu\text{g}/\text{mg}$. This difference between the groups was significant ($P<0.0001$). By 6 weeks however, IgA was detectable at high levels in all infants, with a higher concentration in bottle-fed than in breast-fed infants. There were no significant differences between the groups from 6 weeks to 9 months.

Figure 7 - 4

Immunoglobulin concentrations in saliva, per mg protein

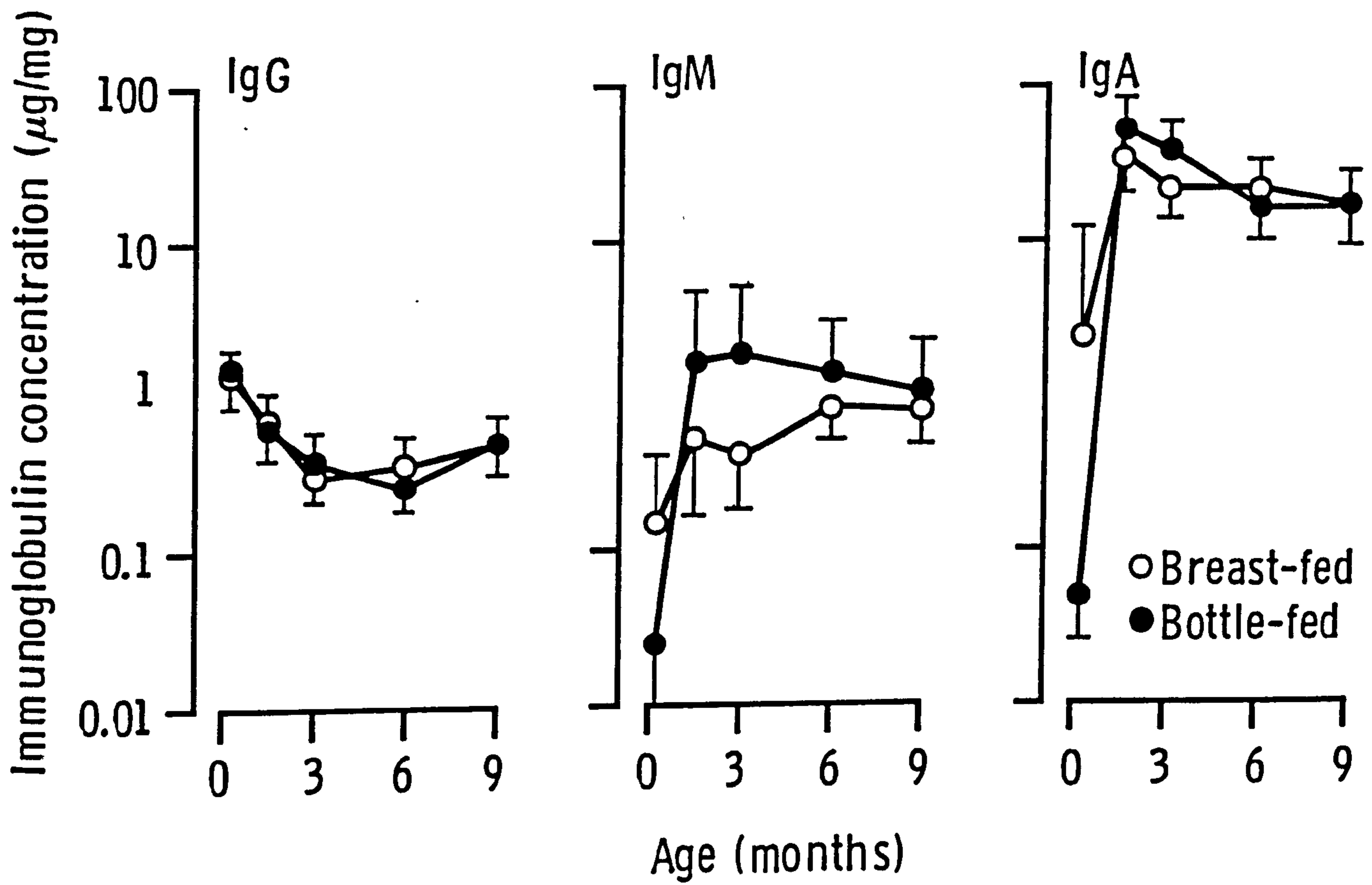


TABLE 7 - 4

IMMUNOGLOBULIN CONCENTRATIONS IN INFANT SALIVA IN RELATION
TO TOTAL PROTEIN CONTENT

FEEDING GROUP	AGE-	6 DY	6 WK	3 M	6 M	9 M
IgG						
BREAST	n =	12	14	15	15	15
	MEAN	1.62*	0.65	0.31	0.35	0.52
	RANGE	0.91-2.52	0.11-1.80	0.14-0.67	0.10-1.67	0.16-1.41
BOTTLE	n =	13	14	14	15	15
	MEAN	1.60	0.63	0.37	0.27	0.48
	RANGE	0.2-4.6	0.11-1.72	0.05-1.4	0.10-0.66	0.18-2.0
	p =	0.98	0.93	0.46	0.52	0.74
IgM						
BREAST	MEAN	0.13	0.54	0.41	0.87	0.78
	RANGE	0.02-2.45	0.04-5.4	0.03-3.3	0.21-4.1	0.18-3.86
BOTTLE	MEAN	0.02	1.64	1.91	1.41	1.23
	RANGE	<0.01-1.3	0.12-18	0.08-16	0.21-10.4	0.17-10
	p =	0.014	0.14	0.015	0.25	0.22
IgA						
BREAST	MEAN	2.34	36.3	22.9	22.4	17.4
	RANGE	0.12-63.5	6.3-195	5.6-154	3.6-60	4.2-88
BOTTLE	MEAN	0.05	53.7	39.8	17.0	15.2
	RANGE	<0.01-0.42	11.5-220	17-91	4.0-76	2.6-69
	p =	0.000	0.28	0.07	0.42	0.68

* Immunoglobulin concentrations in $\mu\text{g}/\text{mg}$ total protein

4) Relationship between immunoglobulin concentrations in the saliva of breast-fed infants and the time since the last milk feed.

Although mothers were asked not to feed their infants within 2 hours of sample collection, this did not always prove practical and samples were collected from between 1 to 6 hours after feeding. To estimate whether those breast-fed infants who had the highest IgA or IgM levels were those who had most recently been breast-fed, Ig levels were correlated with the time since the last intake of breast milk. No significant correlation was found for IgM ($r=0.039$) or IgA ($r=0.004$).

However, for one 6 day old infant, saliva was collected shortly after a feed and again 2 hours later. IgG rose during this time from 0.8 to 1.9 $\mu\text{g}/\text{mg}$. IgM fell from 1.2 to 0.3 $\mu\text{g}/\text{mg}$ and IgA fell from 61 to 20 $\mu\text{g}/\text{mg}$.

5) Relationship between salivary and serum immunoglobulin levels.

i) IgG

When data from all five sample occasions were pooled, there was a significant correlation between IgG in serum and saliva for both feeding groups ($r=0.573$ breast; $r=0.405$ bottle, $DF=85$, $P<0.001$). However when each of the five occasions was analysed separately, this correlation did not reach a significant level for either feeding group.

ii) IgM

When results from 6 day to 9 month samples were pooled, there was a significant correlation between serum and salivary IgM in both feeding groups ($r=0.539$ breast; $r=0.64$ bottle; $P<0.001$). When analysed on

each occasion, there was significant correlation at 6 weeks in the breast-fed group, and at 6 weeks and 6 months in the bottle-fed group.

iii) IgA

When results from all 5 occasions were pooled, for the breast-fed group there was a high degree of correlation between levels of serum and salivary IgA ($r=0.579$, $P<0.001$), which was also significant when analysed by occasion at 6 weeks, 6 and 9 months. In the bottle-fed group however, there was no correlation overall ($r=0.092$) or on any sample occasion between IgA in serum and saliva.

6) Specific antibodies in saliva.

Saliva samples were assayed for G, M and A antibodies to tetanus toxoid and *E.coli*. These results are summarised in Table 7 - 5.

TABLE 7 - 5

SPECIFIC ANTIBODIES IN THE SALIVA OF INFANTS

	IgG			IgM			IgA		
	Tested	+	$\mu\text{g/ml}$	Tested	+	$\mu\text{g/ml}$	Tested	+	$\mu\text{g/ml}$
anti-TT	20	1	135	20	0	<5	20	0	<5
anti- <i>E.coli</i>	20	1	90	32	4	60-100	141	127	5-500

i) Antibodies to tetanus toxoid

Twenty samples of undiluted saliva from 2 breast-fed and 6 bottle-fed infants, between 6 weeks and 9 months of age, were assayed for IgG, IgM and IgA antibodies to tetanus toxoid. The limit of sensitivity of the test for each immunoglobulin was 5-10ng/ml in undiluted saliva. One infant had 135ng/ml IgG anti-TT (sample 25E). No other

TT-specific antibodies of any of the three classes were detected. The corresponding serum IgG anti-TT for the one positive saliva sample was 315 μ g/ml, which was the highest serum antibody titre recorded.

ii) Antibodies to *E.coli*

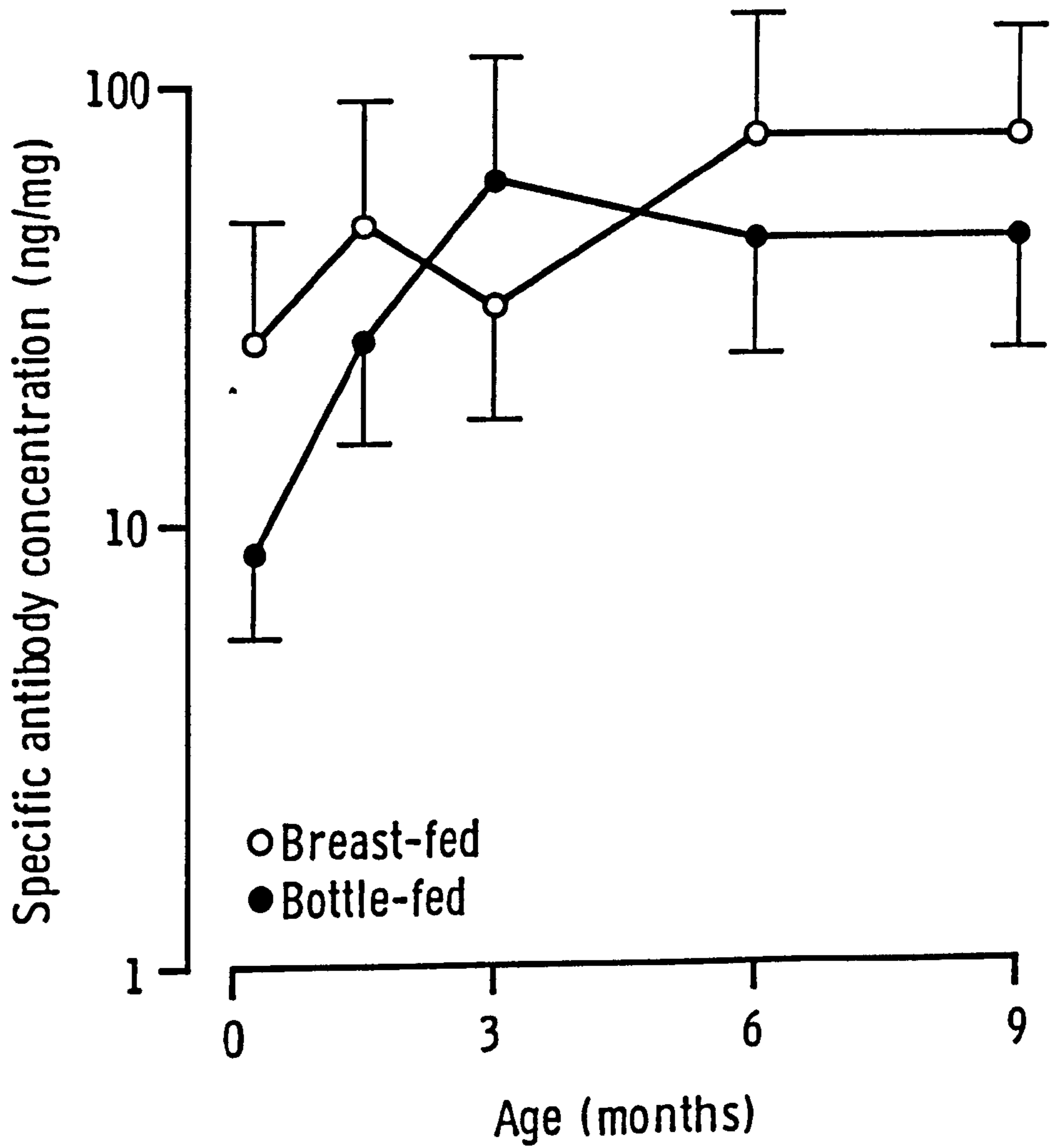
IgG antibodies to *E.coli* were estimated in 20 samples of undiluted saliva from 2 breast-fed and 6 bottle-fed infants, at 6 weeks to 9 months of age. One infant had 90ng/ml IgG anti-*E.coli*, but antibodies were undetectable in the remainder (<10ng/ml).

IgM *E.coli* antibodies were estimated in 32 samples from 4 breast-fed and 7 bottle-fed infants. IgM anti-*E.coli* antibodies at 60-100ng/ml were detected in 1 sample from a breast-fed infant (post-weaning) and 3 samples from bottle-fed infants. In all 4 infants, IgM anti-*E.coli* was undetectable in subsequent samples.

IgA anti-*E.coli* antibodies were detectable at 6 days in 7/11 breast-fed and 2/13 bottle-fed infants (>10ng/mg protein). The higher level of antibodies in the breast-fed infants was significant (P=0.0089). By 6 weeks, IgA anti-*E.coli* antibodies were detectable at low levels in all infants (5-300ng/mg protein). These antibody levels rose very slightly with age (Fig 7 - 5). There were no significant differences between the feeding groups from 6 weeks to 9 months of age.

Figure 7 - 5

IgA antibodies to Escherichia coli in saliva
of breast- and bottle-fed infants



SECTION D - DISCUSSION

1) Development of IgG in saliva of infants.

There have been several studies on the development of IgA in saliva and other secretions but very little work has been carried out on the development of salivary IgM and IgG in infants. Work in adults has indicated that the concentrations of these two immunoglobulins in saliva are much lower than their concentrations in serum (Brandtzaeg, Pjellander and Gjeruldsen, 1970). The present study has shown that this also applies to newborn infants. IgG levels were only 0.02% of the serum levels. Selner, Merrill and Claman (1968) used electroimmunodiffusion to study salivary IgG in newborn infants but they could only detect it in infants between 1-10 days of age, and could not detect it in older infants. They suggested that this low level of IgG was due to leakage of maternally derived IgG from the serum. The limit of detection for their assay was $2\mu\text{g/ml}$. Using the more sensitive RIA technique, the present study has indicated that IgG could be found in the saliva of all infants tested on all occasions between 6 days and 9 months, although it was frequently at concentrations below $2\mu\text{g/ml}$, particularly in the samples collected at 6 and 9 months. The pattern of a decline in IgG during the first 3 months followed by a rise, as immunoglobulin synthesis by the infant increased, was the same as for serum IgG. The finding that serum and salivary IgG concentrations were not correlated at any individual sample occasion (although there was an overall correlation), suggested that although these antibodies may have been the result of leakage from the serum, either the permeability varied considerably between infants, or there was local IgG synthesis which was independent of the

systemic immune system. The demonstration of IgG anti-TT only in the infant who had the highest level of serum IgG anti-TT would suggest some leakage from serum does occur. This is in agreement with studies in adults who have high levels of diphtheria antitoxin (Remington *et al.*, 1964). However, since the IgG anti-TT in the positive saliva represented only 0.04% of the antibody level in serum, a similar diffusion rate in the other infants would have been below the sensitivity of the RIA test. Clearly, IgG diffusion from serum to saliva occurs at a very low level.

2) Development of IgM in infant saliva.

Selner, Merrill and Claman (1968) investigated salivary IgM in 52 samples from 20 infants between birth and 6 weeks and were unable to detect IgM in any of the samples (the minimal sensitivity of their test was $8\mu\text{g/ml}$). In the present study, the minimal sensitivity was $0.02\mu\text{g/ml}$, and IgM was detected as early as 6 days in half the bottle-fed infants (thus showing it was solely of infant origin). By 6 weeks, all infants had detectable IgM, although in only 2 infants was the concentration above $8\mu\text{g/ml}$. The levels found in bottle-fed infants over 6 weeks of age were similar to those found in adults (Brandtzaeg, Pjellanger and Gjeruldsen, 1970). These workers found a ratio of IgG:IgM in adult saliva of 6.86:1, which compares with a ratio of 0.36:1 in the infants in this study at 9 months. IgM therefore represents a higher proportion of the total immunoglobulins in infant saliva, which supports the view that IgM is relatively more important in the secretions of infants than adults (Hanson and Brandtzaeg, 1980).

3) Development of IgA in infant saliva.

Many more studies have investigated IgA levels in secretions, particularly in saliva, the easiest secretion to collect. Haworth and Dilling (1966) and Selner, Merrill and Claman (1968), were unable to detect IgA in saliva before 8-14 days but after that time both groups were able to demonstrate a rapid rise in IgA levels. Burgio *et al.*, (1980) have confirmed these findings, although their work indicated adult levels were achieved more slowly, not until 6-8 years rather than the few months suggested by the earlier studies. The findings reported in the present study also suggest that very low levels of IgA are secreted in the newborn infant, but that there is an enormous increase in production over the first 6 weeks to reach up to 100 μ g/ml IgA. This is similar to the corresponding concentration in serum (96%) and is approximately 50% of adult salivary levels (Brandtzaeg, Fjellanger and Gjeruldsen, 1970). From 6 weeks to 9 months of age the salivary IgA levels declined slightly. Gleeson *et al.*, (1982) have also noted a decline in salivary IgA from 2-6 months. These workers attributed this to a negative feedback, regulated by mucosal T cells, following the initial heavy antigenic challenge by the microbial flora. It might also be due in part to a dilution effect, as the volume of saliva increases during this time and therefore the total daily output will continue to increase. Gleeson and colleagues claimed however, that there were no differences in salivary IgA between breast- and bottle-fed infants, although no data was presented to support this statement.

In this present study, the strong correlation of salivary and serum IgA in breast- but not bottle-fed infants could be due to absorption of breast-milk IgA. However, previous studies do not support this hypothesis (see Chapter 6). It could also be due to ingestion of soluble milk factors, which may regulate local IgA synthesis. The existence of such factors has already been described (Pittard and Bill, 1977a and b). The lack of correlation between salivary and serum IgA in the bottle-fed group may simply reflect the independent routes of local and systemic stimulation by antigens. A similar lack of correlation between secretory and serum antibodies has been described by previous workers (Haworth and Dilling, 1966). Although no mention was made of breast or bottle-feeding in this study, it was conducted in Saskatchewan at a time when breast-feeding rates had reached a nadir in this area.

4) Specific antibodies in saliva.

The specific antibody responses to the two antigens tested were very low in both groups of infants, with only IgA antibodies to *E.coli* being at a detectable level in most infants. These developed similarly in both groups but represented only a very small percentage of the total IgA present (0.1%). Evans and Mergenhagen (1965) demonstrated antibodies to *Shigella* and *Salmonella* in human parotid fluid but were unable to detect antibodies to *E.coli*. Gleeson *et al.*, (1982) also failed to detect *E.coli* antibodies in saliva up to 1 year of age, but these workers used indirect haemagglutination (an insensitive technique known to detect predominantly IgM - see Chapter 6) with a pool of enteropathogenic rather than commensal serotypes. Secretory antibodies to mouth organisms such as *Streptococcus mutans*

have been demonstrated in adult saliva, (Arnold, Mestecky and McGhee, 1976) but because of the high levels of these antibodies in colostrum at the same time, the authors suggested that the gut rather than the mouth was the most important site of priming. Bienenstock has suggested a common mucosal associated immune system in which precursor cells are primed in the gut, migrate via the mesenteric lymph nodes to the general circulation and preferentially relocate at all secretory sites (Bienenstock and Befus, 1980). However, the low level of antibodies to *E.coli* found in the saliva of infants in the present study suggests that the number of cells secreting antibodies to the normal gut flora which relocate higher up in the alimentary tract (i.e. the mouth) is very low compared with the number of cells at that site which secrete antibodies to other antigens (presumably mouth organisms such as Streptococci, Neisseria and Bacteroides, and food antigens). There is good evidence that infants can produce local antibodies to *E.coli* in the gut at this time. Lodinova, Jouja and Wagner (1973) have demonstrated the appearance of local *E.coli* coproantibodies in the stools of infants within 2 days following artificial intestinal colonisation with strain O83, but these workers did not look for antibodies at any other secretory sites such as saliva.

5) Differences in salivary immunoglobulins in breast- and bottle-fed infants.

As with the serum IgG levels, salivary IgG was unaffected by the type of milk the infant was receiving, suggesting that the capacity of the two feeding groups to synthesise IgG develops similarly.

IgM and IgA levels were, however, significantly higher in the saliva of breast-fed infants at 6 days, and although it is possible that this is due to enhanced synthesis, contamination from milk immunoglobulins is a more likely explanation. The use of monoclonal antibodies to allotypic markers would be one way to answer this question. The level of these two immunoglobulins in the bottle-fed group at 6 days was often below the level of detection.

The synthesis of both IgM and IgA increased rapidly in all infants during the first 6 weeks of life. The significantly higher levels of IgM and IgA per millilitre of saliva in the bottle-fed group from 3 to 9 months was associated with a general increase in total protein in this group. However, when this was taken into account, the IgM levels were still significantly higher at 3 months, suggesting a greater antigenic stimulation in the bottle-fed group than the breast-fed group.

The microbial flora in the mouth probably represents the greatest source of antigenic challenge to the local immunocyte population. Salivary antibodies to several oral micro-organisms have been demonstrated (Arnold, Mestecky and McGhee, 1976). The minor salivary glands are thought to be more important than the parotid gland in the regulation of the organisms in the oral environment, as they are more accessible to antigenic stimulation and can produce up to a third of the IgA in the oral cavity (Crawford, Taubman and Smith, 1975). In the breast-fed group, the infants will be receiving large quantities of milk sIgA antibodies to the microbial flora of the mouth (Goldman and Smith, 1973). These antibodies may coat these organisms and prevent them from adhering to the buccal mucosa (Williams and Gibbons,

1972) where they could proliferate and stimulate the local immune system.

The bottle-fed infants will also be receiving a greater stimulation from the highly antigenic cow milk proteins. The specificity of the antibodies produced has not been determined by the present studies. However, the fact that the antibodies are not against gut organisms such as *E.coli*, in spite of increased serum antibodies against *E.coli* in the bottle-fed group (Chapter 6), suggests that immunocytes stimulated in the gut are not relocating to any significant degree in the oral cavity. This is in contrast to the suggestion of Bienenstock (Bienenstock and Befus, 1980) that immunocytes at secretory surfaces are part of a common mucosal associated lymphoid system, with lymphocytes primed in the gut relocating at other secretory sites.

6) Total protein levels in saliva.

Finally, the differences in the total protein levels in breast- and bottle-fed infants at 6 and 9 months is interesting. The preliminary investigations suggest that this may, in part, be due to increased amylase activity in the bottle-fed group. It is possible that the different carbohydrate content of cow milk, compared with human milk, is stimulating enzyme secretion and this finding warrants further investigation.

SUMMARY

The total IgG, IgM and IgA levels and specific antibodies to tetanus toxoid and *E.coli* have been examined in the saliva of infants. IgG levels were low, only 0.02% of serum levels. Incomplete correlation between levels of salivary and serum IgG suggests some local production, although detection of IgG anti- TT only in the infant with the highest serum concentration of this antibody, indicated some salivary IgG may be of systemic origin. There were no significant differences in salivary IgG between the two feeding groups.

In contrast, concentrations of IgM and IgA were significantly higher in the breast-fed infants at 6 days; this is most probably due directly to colostrum and milk antibodies. IgM and IgA antibodies were frequently below the level of detection at 6 days in the bottle-fed infants. IgM and IgA levels increased rapidly in all infants during the first 6 weeks of life, presumably as a result of colonisation with micro-organisms and exposure to food antigens. The IgM in infant saliva represented a higher proportion of the total immunoglobulins than in adult saliva. By 3 months, IgM and IgA levels were significantly higher in the saliva of bottle-fed infants than breast-fed infants. It is suggested that this is due to higher local antigenic stimulation in the bottle-fed group, partly from cow milk proteins and partly from oral micro-organisms. In the breast-fed infants, the protective effect of milk antibodies against organisms in the oral cavity may be reducing their attachment and replication on the buccal mucosa. The correlation of salivary and serum IgA in the breast-fed but not the bottle-fed group supports the hypothesis that a

soluble factor in breast milk could be enhancing IgA secretion both locally and systemically.

Specific IgM and IgA antibodies to tetanus toxoid were undetectable in all infants tested. IgG and IgM antibodies to *E.coli* were low or undetectable. IgA antibodies to *E.coli* were detected in all infants by 6 weeks but at very low levels and there were no significant differences between the feeding groups. Lymphocytes stimulated in the gut which relocate in the oral cavity therefore appear to represent only a very small proportion of the local Ig secreting cells at this site in infants.

The total protein concentration in the saliva of the bottle-fed infants was higher than that in the saliva from breast-fed infants. This could not be attributed solely to the higher immunoglobulin levels, and preliminary investigations indicated that it may be due to increased amylase activity in the bottle-fed group.

CHAPTER 8
GENERAL DISCUSSION

There are many factors in human milk which have antimicrobial activity *in vitro* and are thought to have an important role in passive protection within the gut of the breast-fed infant. The aim of this study was to determine whether, in addition to the local passive protective effect of these antimicrobial factors, there was any active role of the lymphokines and growth factors demonstrated in human milk, in stimulating the development of immune responses in infants. Although the results obtained have highlighted a number of areas where the development of immunity differs between breast- and bottle-fed infants, these differences are not always attributable to an active enhancing effect of breast milk. It appears that both passive protection and active enhancement interact to affect immunological development.

1) Differences between the feeding groups

The results obtained from the studies on systemic and local immunity *in vivo*, and the examination of lymphocyte proliferation and function *in vitro* fall into three broad categories. They are those in which immune function appears :- a) enhanced in breast-fed infants, b) equal in both groups of infants, c) enhanced in bottle-fed infants. It is clear from the data that these categories depend primarily on the age of the infant.

a) The functions which appear enhanced in breast-fed infants become apparent during the first few weeks of life. They are the spontaneous proliferation of peripheral blood mononuclear cells (PBM),

the proliferative responses of these cells to stimuli such as the mitogen PHA and the antigen tetanus toxoid, and a more rapid response to allogeneic lymphocytes. While it is not possible to draw any firm conclusions about the cell types responsible for producing this different pattern of proliferation between breast- and bottle-fed infants, a provisional assessment is feasible. Thus, spontaneous proliferation has been attributed to a population of non-T/non-B cells which are possibly T cell precursors (Treves, Barak and Fuks, 1980) whereas PHA and allogeneic lymphocytes stimulate primarily T cells (Rich and Pierce, 1973; Kuntz, Innes and Weksler, 1976). In contrast, tetanus toxoid may stimulate both T and B cells. Therefore, T cell precursors, T cells and possibly some B cells may all be proliferating more in newborn breast-fed infants and this could be attributable to stimulation by lymphokines or other growth factors in human milk. It should also be noted that cells from both breast-fed and bottle-fed infants have in general a higher rate of spontaneous and mitogen induced proliferation than do adult cells. This has been attributed to a partial activation of infant cells *in vivo* (Stites *et al.*, 1972; Weber, Santesson and Skoog, 1973). It was unfortunate that limited cell numbers did not permit correlation of this increased proliferation in breast-fed infants with immunoglobulin production *in vitro* and this is an area which warrants further investigation.

Breast-fed infants also had higher levels of IgA and IgM in their saliva at 6 days of age than bottle-fed infants. Clearly, the protective effect of breast-feeding lasts beyond the disappearance of milk from the oral cavity, although whether this is due to the attachment of milk immunoglobulins to receptors on the buccal mucosa (Roberts, Wincup and Harries, 1980) or to induction of local IgA and

IgM synthesis by growth factors in milk is not known.

b) The immunological functions that were found to develop similarly in the two feeding groups were the total immunoglobulin levels in serum, the antibody responses to TT vaccination and the total IgG levels in saliva. This indicates that the general capacity to mount antibody responses to antigens developed at a comparable rate in both groups. This conclusion is also supported by the findings of Zoppi *et al.*, (1983) who showed similar antibody responses to diphtheria and pertussis vaccination in breast-fed and well nourished bottle-fed infants. In addition, most studies of serum immunoglobulins and antibodies, designed to determine whether breast milk immunoglobulins are absorbed by the neonatal gut, have shown similar immunoglobulin levels in both groups. There is still the possibility that some dimeric IgA may be absorbed from milk, yet not detected in the serum because it is being rapidly transported from the blood back into bile via secretory component receptors on the hepatocytes. This is a transport mechanism that has been demonstrated in rats (Orlans *et al.*, 1978). However, studies in humans have indicated that this is not such an important mechanism as in rodents (Delacroix *et al.*, 1982).

c) It was the third group of results, in which bottle-fed infants had enhanced immune responses over those of the breast-fed infants, that were initially the most surprising: they were also statistically the most significant! The functions which were enhanced in bottle-fed infants were systemic IgM responses to commensal *E.coli* from 6 days onwards, local IgM and IgA production in saliva from 6 weeks of age,

and from 3 to 9 months of age the spontaneous proliferation of PBM cells and proliferative responses to all stimuli tested. This was in contrast to the increased proliferative responses which occur from 6 days to 3 months in the breast-fed infants - see a) above. All these enhanced immune responses in bottle-fed infants can be explained by the single phenomenon of increased exposure to gut antigens (Chapter 6). There are three possible reasons for this increased exposure in bottle-fed infants. First, there is a higher antigen intake, in the form of cow milk proteins. Second, the protective effects of human milk antibodies and other antimicrobial proteins are lacking. Third, the absence of epithelial growth factors present in human milk may delay the maturation of gut impermeability.

i) The role of cow milk antigens.

Human milk is not devoid of material which is potentially antigenic to the infant, in fact food antigens such as egg protein, cow milk proteins and theobromine from chocolate are known to be transferred to the infant by this route (Resman, Blumenthal and Jusko, 1977; Jakobsson and Lindberg, 1978). However antibodies against food antigens are also transferred in the milk and these antibodies have been shown to inhibit uptake of undegraded food molecules by the gut of the infant (Cruz, 1983). Cow milk proteins such as casein however, which are present in such large quantities in cow milk formulae, are known to be highly antigenic (see Chapter 6) and to stimulate not only local immune tissues but also a high level of systemic IgG antibodies in bottle-fed infants (Kletter *et al.*, 1971). Soy-protein based formulae are equally antigenic (Eastham *et al.*, 1978). Tolo, Brandzaeg and Jonsen (1977) have shown that IgG antibodies limit the

systemic uptake of homologous antigen but will actually enhance uptake of unrelated antigens. This increased permeability is probably due to release of lysosomal enzymes by phagocytic cells which take up the IgG immune complexes. Systemic IgG antibodies to cow milk proteins might therefore be enhancing the uptake of other gut antigens such as those from commensal organisms of the normal gut flora.

ii) The role of passive protective factors in human milk in modulating antigenic exposure.

An important requirement for the pathogenesis of many micro-organisms is that they should be able to adhere to mucosal surfaces. Human milk has been shown to have anti-adhesive properties of a specific and non-specific nature, as well as bacteriostatic and agglutinating properties (see Chapter 1). By reducing attachment and the subsequent replication and invasion of organisms, these passive protective effects will simultaneously protect the local immune system from antigenic challenge; such challenge is itself a potent stimulator of proliferation and differentiation in lymphoid tissues. In fact in mice, both food antigens and normal gut flora have been shown to be important in stimulating the appearance of IgA containing cells in gut tissues (Sagie *et al.*, 1974). It is these contrasting effects which make it so difficult to separate the passive and active roles of milk in the development of immune responses in infants, as they act in opposite directions.

iii) Active protection of infants by growth factors in milk.

In addition to the possible effects of lymphokines in human milk modulating the development of local and systemic lymphoid tissue in breast-fed infants, (which has been discussed above) there remains the possibility that growth factors for epithelial cells could be having an indirect effect on development of immune responses by decreasing antigenic exposure. In newborn infants the gut mucosa is more permeable to all macromolecules than in adults (Chandra, 1979). This gives rise to uptake of microbial and food antigens. In breast-fed infants epithelial growth factors may be stimulating the maturation of gut epithelium and thereby enhancing the gut closure to macromolecules.

2) The role of normal gut flora in development of immune responses.

Since the evidence presented suggests a difference between the two groups in systemic exposure to components of the normal gut flora, it is interesting to note some possible effects of gut flora on the development of immune responses. The commensal gut flora starts to become established within hours of birth, when the infant's secretory immune system is particularly immature (see Chapter 1). Many factors control the development of this flora (Borriello and Stephens, 1984) and human milk has a modulating effect. One of the bacterial components reported to be higher in the flora of bottle-fed infants than breast-fed infants is the gram-negative Enterobacteriaceae. These include commensal organisms such as *E.coli* but also include potential pathogens such as *Shigella*, *Salmonella*, *Vibrio cholerae* and enteropathogenic and enterotoxigenic *E.coli*, all known to be important

causes of infections in neonates. These organisms also have, in their cell walls, lipopolysaccharide (LPS). LPS from normal gut flora is known to have regulating effects on immune responses, not only in animal models (Lagrange *et al.*, 1975a and b; Cebra *et al.*, 1980; Kiyono, McGhee and Michalek, 1980; Citron and Michael, 1981; Jacobs *et al.*, 1983; Tlaskalova-Hogenova *et al.*, 1983) but also in humans (van der Waaij and Heidt, 1977; Hand and Smith, 1981). In fact the latter workers noted the similarities between biologically active molecules produced by *E.coli* (cytokines) and lymphokines. The results from the serum studies described in this thesis indicate that systemic specific antibody responses to *E.coli* LPS are greatly increased in the bottle-fed infants, suggesting that this antigen has indeed penetrated the gut mucosa. Perhaps more importantly, LPS can also act as a non-specific mitogen/adjuvant. This role has been put to positive use in adults by administration of LPS to enhance systemic responses to antigens such as tetanus toxoid (Rethy, 1983). Live *E.coli* and *Streptococcus faecalis* have also been administered as an oral vaccine to relieve a variety of non-specific ailments such as chronic and recurrent respiratory tract infections and skin disorders (Rusch, Hyde and Luckey, 1983). Experiments in mice indicate that these vaccines stimulate an increase in non-specific immunity but their mechanism of action is not fully understood.

Clearly there are many reasons why the effects of increased antigenic challenge from cow milk proteins and increased exposure to gut micro-organisms could have a profound effect on the development of immune responses in bottle-fed infants. The observations of increased immunity to locally encountered antigens and increased

proliferative responses of lymphocytes from 3 to 9 months of age in bottle-fed infants might lead one to think that bottle-feeding is actually better than breast-feeding at stimulating the development of immunity. Certainly the relative infection rates in the two groups of infants in this study showed no greater susceptibility of bottle-fed infants to infections, although it must be emphasised that infection rates were generally low in both groups. Also, it is clear that breast milk does not totally protect infants from the infections to which they are exposed. The correlation of lower sibling numbers with lower infection rates confirms the belief that it is more important to limit the exposure of newborn infants to infectious agents. The enormous improvement in infant morbidity and mortality in developed countries over the last 50 years has been largely due to the general reduction in exposure rates and this lower exposure rate is an important fact when considering the additional benefits of breast-feeding. However, given that it is impossible to reduce the risk of contact with infectious agents to zero, the question arises of what is the best way to reduce the risk of contracting infections?

Breast-feeding, although not providing total protection, is still the best option and mothers must be encouraged to pursue this method of feeding wherever possible. The period during which the stimulatory effects of breast milk on lymphocyte proliferation and differentiation are most apparent, is the first few weeks of life when the infant is most vulnerable due to the naivety of the immune system. For this early period, breast feeding should clearly be an advantage, particularly in areas of high disease incidence. The role of breast milk in providing antigen exclusion and modulation of lymphocyte function is certainly more than an *in vitro* artefact. Antigen

exclusion may be particularly important in infants who have a high risk of developing atopic disease. In contrast, the modulation of immune responses in bottle-fed infants by increased antigenic exposure may have a similar stimulating effect, but these effects may come too late. It also seems rather like playing Russian roulette, all may go well providing the stimulating antigen is not enteropathogenic *E.coli* or some other potentially lethal organism. It is possible that the differences between the breast- and bottle- fed groups would be more marked if this study had been done in an underdeveloped country with its more hazardous antigenic environment.

Modification of the commercially available milk formulae is obviously possible. Complementary DNA lymphokines and epidermal growth factors are now becoming available and there is a possibility that these products could be added to cow milk preparations, although work still needs to be done to identify which of the lymphokines in milk are important to the newborn infant. However, this is only one aspect of the regulation of development of immunity. It is difficult to imagine how the balance created by the combined effects of antigen exclusion, protective and cell growth factors, and modulation of normal gut flora, could be recreated with an artificial cow milk (or soy protein) based formula. In order to achieve exclusion of large quantities of foreign protein one would have to start with a human milk base. Preservation of this product by any technique would result in loss of many of the antimicrobial proteins (Editorial, 1979). However potentially, these could be added back together with immune modulators and growth factors. One might even consider adding small quantities of LPS to this product to stimulate further immunological development! This would make a product which would be prohibitively

expensive for general use but could be used for children at high risk of infections or allergic disease who for some reason cannot be fed by their own mothers. At present this need is being satisfied in some areas by the use of human milk banks and human milk is still being used to control outbreaks of diarrhoea where antibiotics have failed (McFarlane and Miller, 1984). However, the problems of milk collection, preservation and storage without gross microbial contamination or destruction of antimicrobial proteins still remain great. Perhaps a more practical (but less commercial) alternative would be the return of wet nursing!

REFERENCES

- ADDY, D.P. (1976) Infant feeding: a current view. *Br. med. J.*, 1, 1268-1271.
- ADINOLFI, M., GLYNN, A.A., LINDSAY, M. and MILNE, C.M. (1966) Serological properties of gamma-A antibodies to *Escherichia coli* present in human colostrum. *Immunol.*, 10, 517-521.
- AGUNOD, M., YAMAGUCHI, N., LOPEZ, R., LUHBY, A.L. and GLASS, G.B.J. (1969) Correlative study of hydrochloric acid, pepsin and intrinsic factor secretion in newborns and infants. *Am. J. Dig. Dis.*, 14, 400.
- AHLSTEDT, S., JODAL, U., HANSON, L.A. and HOLMGREN, J. (1975) Quantitation of *Escherichia coli* O antibodies by direct and indirect agglutination in comparison with a radioimmunoassay. *Int. Arch. Allergy appl. Immunol.*, 48, 445-451.
- ALFORD, C.A., SCHAEFER, J., BLANKENSHIP, W.J., STRAUMFORD, J.V. and CASSADY, G. (1967) A correlative immunologic, microbiologic and clinical approach to the diagnosis of acute and chronic infections in newborn infants. *New Eng. J. Med.*, 277, 437-449.
- ALFORD, R.H., CARTWRIGHT, B.B. and SELL, S.H. (1976) Ontogeny of human cell-mediated immunity: Age related variation of *in vitro* infantile lymphocyte transformation. *Infect. Immun.*, 13, 1170-1175.
- ALLANSMITH, M., McCLELLAN, B.H., BUTTERWORTH, M. and MALONEY, J.R. (1968) The development of immunoglobulin levels in man. *J. Pediatr.*, 72, 276-290.
- ALLARDYCE, R.A. and WILSON, A. (1984) Breast milk supernatants from atopic donors stimulate cord blood IgE secretion *in vitro*. *Clinical Allergy*, 14, 259-267.
- AMMANN, A.J. and STIEHM, E.R. (1966) Immune globulin levels in colostrum and breast milk, and serum from formula- and breast-fed newborns. *Proc. Soc. Exptl. Biol. Med.*, 122, 1098-1100.
- ANDERSEN, V., DUPONT, B., SONDERSTRUP, G., THOMSEN, M. and OTTOSEN, J. (1973) Antigen-induced lymphocyte transformation *in vitro*: studies in newborns and their mothers. *Scand. J. Immunol.*, 2, 81.
- ANDERSSON, U., BIRD, G. and BRITTON, S. (1980) Cellular mechanisms of restricted immunoglobulin formation in the human neonate. *Eur. J. Immunol.*, 10, 888-894.
- ANDERSSON, U., BIRD, G. and BRITTON, S. (1981) A sequential study of human B lymphocyte function from birth to two years of age. *Acta Paediatr. Scand.*, 70, 837-842.
- ANDERSSON, U., BRITTON, S., De LEY, M. and BIRD, G. (1983) Evidence for the ontogenic precedence of suppressor T cell functions in the human neonate. *Eur. J. Immunol.*, 13, 6-13.

- ARNOLD, R.J., MESTECKY, J. and MCGHEE, J. (1976) Naturally occurring secretory immunoglobulin A antibodies to *Streptococcus mutans* in human colostrum and saliva. *Infect. Immun.*, 14, 355-362.
- AUGUST, C.S., BERKEL, A.I., DRISCOLL, S. and MERLER, E. (1971) Onset of lymphocyte function in the developing human fetus. *Pediatr. Res.*, 5, 539-547.
- BANCK, G. and FORSGREN, A. (1978) Many bacterial species are mitogenic for human blood B lymphocytes. *Scand. J. Immunol.*, 8, 347-354.
- BEARDMORE, J.M., LEWIS-JONES, D.I. and RICHARDS, R.C. (1983) Urogastrone and lactose concentrations in precolostrum, colostrum and milk. *Pediatr. Res.*, 17, 825-828.
- BEER, A.E., BILLINGHAM, R.E. and HEAD, J. (1974) The immunologic significance of the mammary gland. *J. invest. Dermatol.*, 63, 65-74.
- BEN-ZVI, A., GALILI, U., RUSSELL, A. and SCHLESINGER, M. (1977) Age-associated changes in subpopulations of human lymphocytes. *Clin. Immunol. Immunopathol.*, 7, 139-149.
- BERG, R.D. (1980) Mechanisms confining indigenous bacteria to the gastrointestinal tract. *Am. J. Clin. Nutr.*, 33, 2472-2484.
- BERG, T. (1969) The immunoglobulin development during the first year of life. A longitudinal study. *Acta Paediatr. Scand.*, 58, 229-236.
- BERG, T. and JOHANSSON, S.G.O. (1969) Immunoglobulin levels during childhood, with special regard to IgE. *Acta Paediatr. Scand.*, 58, 513-524.
- BIENENSTOCK, J. (1974) The physiology of the local immune response and the gastrointestinal tract. *Progr. Immunol. II.*, 4, 197-207.
- BIENENSTOCK, J. and BEFUS, A.D. (1980) Mucosal immunology (A review). *Immunology*, 41, 249-270.
- BJORKSTEN, B. (1983) Does breast-feeding prevent the development of allergy. *Immunol. Today*, 4, 215-217.
- BLAU, H., PASSWELL, J.H., LEVANON, M., DAVIDSON, J., KOHEN, F. and RAMOT, B. (1983) Studies on human milk macrophages: Effect of activation on phagocytosis, and secretion of prostaglandin E2 and lysozyme. *Pediatr. Res.*, 17, 241-245.
- BLOOM, K., GOLDBLOOM, R.B. and STEVENS, F.E. (1982) III Differences in infant care and health independent of socioeconomic status. *Acta Paediatr. Scand. Suppl.*, 300, 15-26.
- BORRIELLO, S.P. and STEPHENS, S. (1984) The development of the infant gut flora; and the medical microbiology of infant botulism and necrotising enterocolitis. In "Microbes and Infections of the Gut" Ed. C.S. Goodwin, Blackwell Scientific, 1-26.

- BRADFORD, M.M. (1976) A rapid and sensitive method for the quantitation of microgram quantities of protein utilizing the principle of protein-dye binding. *Analytical Biochemistry*, 72, 248-254.
- BRANDTZAEG, P. (1978) Polymeric IgA is complexed with secretory component (SC) on the surface of human intestinal epithelial cells. *Scand. J. Immunol.*, 8, 39-52.
- BRANDTZAEG, P., FJELLANGER, I. and GJERULDSSEN, S.T. (1970) Human secretory immunoglobulins. I. Salivary secretions from individuals with normal or low levels of serum immunoglobulins. *Scand. J. Haematol. Suppl.*, 12, 1-82.
- BRENNER, M.K. (1981) Investigation of human lymphocyte interaction *in vitro*. PhD Thesis, University of Cambridge, 1-192.
- BRENNER, M.K. and MUNRO, A.J. (1981) T-cell help in human *in-vitro* antibody-producing systems: role of inhibitory T cells in masking allogeneic help. *Cell. Immunol.*, 57, 201-208.
- BRENNER, M.K., NEWTON, C.A., NORTH, M.E., WEYMAN, C. and FARRANT, J. (1983) The interaction of specific T-cell help and non-specific B-cell growth factors in the production of anti-tetanus antibody by human B cells grown in serum-free microcultures. *Immunology*, 50, 377-385.
- BRENNER, M.K., NORTH, M.E., CHADDA, H.R. and FARRANT, J. (1984) Non-specific factor enhancement of human *in vitro* antigen-dependent antibody synthesis: role of B cell activation and T cell help. *Immunology*, 51, 783-791.
- BUCKLEY, R.H., DEES, S.C. and O'FALLON, W.M. (1967) Serum immunoglobulins: I. Levels in normal children and in uncomplicated childhood allergy. *Pediatrics*, 41, 600-611.
- BULLEN, C.W. and WILLIS, A.T. (1971) Resistance of the breast-fed infant to gastroenteritis. *Br. med. J.*, 3, 338-343.
- BULLEN, J.J. (1981) The role of milk and gut flora in protection of the newborn against infection. In "Immunological Aspects of Infection in the Fetus and Newborn", Eds. H.P. Lambert and C.B.S. Wood, Academic Press, 123-129.
- BULLEN, J.J., ROGERS, H.J. and LEIGH, L. (1972) Iron-binding proteins in milk and resistance to *Escherichia coli* infection in infants. *Br. med. J.*, 1, 69-75.
- BURGIO, G.R., LANZAVECCHIA, A., PLEBANI, A., JAYAKAR, S. and UGAZIO, A.G. (1980) Ontogeny of secretory immunity: levels of secretory IgA and natural antibodies in saliva. *Pediatr. Res.*, 14, 1111-1114.
- BUTLER, J.E. (1979) Immunologic aspects of breast feeding, anti-infectious activity of breast milk. *Seminars in Perinatology*, 3, 255-270.

- CALLARD, R.E. (1979) Specific *in vitro* antibody response to influenza virus by human blood lymphocytes. *Nature*, 282, 734-736.
- CANTEY, J.E. (1978) Prevention of bacterial infections of mucosal surfaces by immune secretory IgA. *Adv. exp. Med. Biol.*, 107, 461-470.
- CANTOR, H. (1979) Control of the immune system by inhibitor and inducer T lymphocytes. *Ann. Rev. Med.*, 30, 269-277.
- CARLSSON, B., GOTHEFORS, L., AHLSTEDT, S., HANSON, L.A. and WINBERG, J. (1976) Studies of *Escherichia coli* O antigen specific antibodies in human milk, maternal serum and cord blood. *Acta Paediatr. Scand.*, 65, 216-224.
- CARPENTER, G. (1980) Epidermal growth factor is a major growth-promoting agent in human milk. *Science*, 210, 198-199.
- CARR, M.C., STITES, D.P. and FUDENBERG, H.H. (1972) Cellular immune aspects of the human fetal-maternal relationship. I. *In vitro* response of cord blood lymphocytes to phytohaemagglutinin. *Cell. Immunol.*, 5, 21-29.
- CARR, M.C., STITES, D.P. and FUDENBERG, H.H. (1973) Dissociation of responses to phytohaemagglutinin and adult allogeneic lymphocytes in human foetal lymphoid tissue. *Nature (New Biology)*, 241, 279-281.
- CEBRA, J.J., GEARHART, P.J., HALSEY, J.F., HURWITZ, J.L. and SHAHIN, R.D. (1980) Role of environmental antigens in the ontogeny of the secretory immune response. *J. Reticuloendothel. Soc.*, 28, 61s-71s.
- CHANDRA, R.K. (1975) Food antibodies in malnutrition. *Arch. Dis. Childh.*, 50, 532-534.
- CHANDRA, R.K. (1978) Immunological aspects of human milk. *Nutr. Rev.*, 36, 265-272.
- CHANDRA, R.K. (1979) Prospective studies on the effect of breast-feeding on incidence of infection and allergy. *Acta Paediatr. Scand.*, 68, 691-694.
- CHANDRA, R.K. (1980) Immunology of nutritional disorders. *Current Topics in Immunology Series 12.*, Edward Arnold., 1-110.
- CHANDRA, R.K., COOPER, M.D., HITZIG, W.H., ROSEN, F.S., SELIGMANN, M., SOOTHILL, J.F. and TERRY, R.J. (1978) Immunodeficiency. Report of a WHO Scientific Group, Technical Report Series 630, 1-80.
- CITRON, M.O. and MICHAEL, J.G. (1981) Regulation of the immune response to bacterial lipopolysaccharide by adherent cells. *Infect. Immun.*, 33, 519-522.
- COHEN, A.B., GOLDBERG, S. and LONDON, R.L. (1970) Immunoglobulins in nasal secretions of infants. *Clin. exp. Immunol.*, 6, 753-760.

- COLTEN, H.R. and BIENENSTOCK, J. (1974) Lack of C3 activation through classical or alternate pathways by human secretory IgA anti-blood group antibody. *Adv. exp. Med. Biol.*, 45, 305-308.
- COOKE, J.V. and JONES, F.G. (1943) Duration of passive tetanus immunity and its effect on active immunisation with tetanus toxoid. *J. Am. med. Assoc.*, 121, 1201-1209.
- COOPER, M.D., LAWTON, A.R. and BOCKMAN, D.E. (1971) Agammaglobulinaemia with B lymphocytes. Specific defect of plasma-cell differentiation. *Lancet*, ii, 791-794.
- CRABBE, P.A. and HEREMANS, J.F. (1966) The distribution of immunoglobulin-containing cells along the human gastrointestinal tract. *Gastroenterology*, 51, 305-316.
- CRAGO, S.S., KULHAVY, R., PRINCE, S.J. and MESTECKY, J. (1981) Inhibition of the pokeweed mitogen-induced response of normal peripheral blood lymphocytes by humoral components of colostrum. *Clin. exp. Immunol.*, 45, 386-392.
- CRAIG, S.W. and CEBRA, J.J. (1971) Peyer's patches: An enriched source of precursors for IgA producing immunocytes in the rabbit. *J. exp. Med.*, 134, 188-200.
- CRAWFORD, J.M., TAUBMAN, M.A. and SMITH, D.J. (1975) Minor salivary glands as a major source of secretory immunoglobulin A in the human oral cavity. *Science*, 190, 1206-1209.
- CRUZ, J.R. (1983) Specific immune response in human milk to oral immunization with food proteins. *Ann. N.Y. Acad. Sci.*, 409, 808-809.
- CUNNINGHAM, A.S. (1977) Morbidity in breast-fed and artificially-fed infants. *J. Pediatr.*, 90, 726-729.
- CUNNINGHAM, A.S. (1979) Morbidity in breast-fed and artificially-fed infants. II. *J. Pediatr.*, 95, 685-689.
- DALLMAN, P.R. (1977) *Pediatrics*. Ed. A.M. Rudolph, New York Appleton-Century-Crofts Inc., 1178.
- DAVIS, R.H. and GALANT, S.P. (1975) Non-immune rosette formation. A measure of the newborn infants' cellular immune response. *J. Pediatr.*, 87, 449-452.
- DE LA CONCHA, E.G., OLDHAM, G., WEBSTER, A.D.B., ASHERSON, G.L. and PLATTS-MILLS, T.A.E. (1977) Quantitative measurements of T- and B-cell function in 'variable' primary hypogammaglobulinaemia: evidence for a consistent B-cell defect. *Clin. exp. Immunol.*, 27, 208-215.
- DELACROIX, D.L., HODGSON, H.J.F., MCPHERSON, A., DIVE, C. and VAERMAN, J.P. (1982) Selective transport of polymeric immunoglobulin A in bile. Quantitative relationships of monomeric and polymeric IgA, IgM and other proteins in serum, bile and saliva. *J. Clin. Invest.*, 70, 230-241.

- DEPARTMENT OF HEALTH AND SOCIAL SECURITY. (1974) Report on health and social subjects. Present-day practice in infant feeding. H.M.S.O., 9, 1-38.
- DIAZ-JOUANEN, E.P., STRICKLAND, R.G. and WILLIAMS JR, R.C. (1975) Studies of human lymphocytes in the newborn and the aged. *Am. J. Med.*, 58, 620-628.
- DIAZ-JOUANEN, E.P. and WILLIAMS, R.C. (1974) T and B lymphocytes in human colostrum. *Clin. Immunol. Immunopathol.*, 3, 248-255.
- DOSSET, J.H., WILLIAMS, R.C. and QUIE, P.G. (1969) Studies on interaction of bacteria, serum factors and polymorphonuclear leukocytes in mothers and newborns. *Pediatrics*, 44, 49-57.
- DOWD, P.S. and HEATLEY, R.V. (1984) The influence of undernutrition on immunity. *Clin. Science*, 66, 241-248.
- EARDLEY, D.D., STASKAWICZ, M.O. and GERSHON, R.K. (1976) Suppressor cells: dependence on assay conditions for functional activity. *J. exp. Med.*, 143, 1211-1219.
- EASTHAM, E.J., LICHAUCCO, T., GRADY, M.I. and WALKER, W.A. (1978) Antigenicity of infant formulas: Role of immature intestine on protein permeability. *J. Pediatr.*, 93, 561-564.
- EASTHAM, E.J. and WALKER, W.A. (1977) Effect of cow's milk on the gastrointestinal tract: A persistent dilemma for the pediatrician. *Pediatrics*, 60, 477-481.
- EASTHAM, E.J. and WALKER, W.A. (1979) Adverse effects of milk formula ingestion on the gastrointestinal tract. An update. *Gastroenterology*, 76, 365-374.
- EBBS, J.H. and MULLIGAN, F. (1942) The incidence and mortality of breast- and artificially-fed infants admitted to hospital with infections. *Arch. Dis. Childh.*, 17, 217-219.
- EDITORIAL. (1979) Sterilization of human milk. *Lancet*, i, 913.
- EIFE, R.F., EIFE, G., AUGUST, C.S., KUHERE, W.L. and STAEHR-JOHANSEN, K. (1974) Lymphotoxin production and blast cell transformation by cord blood lymphocytes: Dissociated lymphocyte function in newborn infants. *Cell. Immunol.*, 14, 435-442.
- EMODI, G. and JUST, M. (1974) Interferon production by lymphocytes in human milk. *Scand. J. Immunol.*, 3, 157-160.
- EVANS, R.T. and MERGENHAGEN, S.E. (1965) Occurrence of natural antibacterial antibody in human parotid fluid. *Proc. Soc. Exp. Biol. Med.*, 119, 815-819.
- FARRANT, J., CLARK, J.C., LEE, H., KNIGHT, S.C. and O'BRIEN, J. (1980) Conditions for measuring DNA synthesis in PHA stimulated human lymphocytes in 20 μ l hanging drops with various cell concentrations and periods of culture. *J. Imm. Methods*, 33, 301-312.

- FARRANT, J. and KNIGHT, S.C. (1979) Help and suppression by lymphoid cells as a function of cellular concentration. Proc. Natl. Acad. Sci. U.S.A., 76, 3507-3510.
- FARRANT, J., NEWTON, C.A., NORTH, M.E., WEYMAN, C. and BRENNER, M.K. (1984) Production of antibody by human B cells under serum-free conditions. J. Imm. Methods, 68, 25-34.
- FAUCI, A.S. and PRATT, K.R. (1976) Polyclonal activation of bone-marrow-derived lymphocytes from human peripheral blood measured by a direct plaque-forming cell assay. Proc. Natl. Acad. Sci., 73, 3676-3679.
- FAULK, W.P., GOODMAN, J.R., MALONEY, M.A., FUDENBERG, H.H. and YOPPEY, J.M. (1973) Morphology and nucleoside incorporation of human neonatal lymphocytes. Cellular Immunol., 8, 166-172.
- FERGUSON, A.C. and CHEUNG, S.C. (1981) Modulation of immunoglobulin M and G synthesis by monocytes and T lymphocytes in the newborn infant. J. Pediatr., 98, 385-391.
- FERGUSON, D.M., HORWOOD, L.J. and SHANNON, F.T. (1983) Asthma and infant diet. Arch. Dis. Childh., 58, 48-51.
- FIELD, E.J. and CASPARY, E.A. (1971) Is maternal lymphocyte sensitisation passed on to the child? Lancet, ii, 337-341.
- FRANCE, G.L., MARMER, D.J. and STEELE, R.W. (1980) Breast-feeding and Salmonella infection. Am. J. Dis. Child., 134, 147-152.
- GEHA, R.S., MUDAWWAR, P. and SCHNEEBERGER, E. (1977) The specificity of T-cell helper factor in man. J. exp. Med., 145, 1436-1448.
- GERRARD, J.W., KO, C.G., DALGLEISH, R. and TAN, L.K-T. (1977) Immunoglobulin levels in white and metis communities in Saskatchewan. Clin. exp. Immunol., 29, 447-456.
- GILL III, T.J., RABIN, B.S., HARINA, B.M. and TAYLOR, F.H. (1979) Relationship between the responsiveness of maternal and foetal lymphocytes to phytohaemagglutinin and to microbial antigens. J. Immunogen., 6, 197-214.
- GILL, J.L. (1978) Design and Analysis of Experiments. Vol 1, Iowa State University Press, 176-177.
- GITLIN, D. and BIASUCCI, A. (1969) Development of γ G, γ A, γ M, β 1C/ β 1A, C'1 esterase inhibitor, ceruloplasmin, transferrin, hemopexin, haptoglobin, fibrinogen, plasminogen, α 1-antitrypsin, orosomuroid, β -lipoprotein, α 2-macroglobulin and pre-albumin in the human conceptus. J. Clin. Invest., 48, 1433-1446.
- GLEESON, M., CRIPPS, A.W., CLANCY, R.L., HUSBAND, A.J., HENSLEY, M.J. and LEEDER, S.R. (1982) Ontogeny of the secretory immune system in man. Aust. N. Z. J. Med., 12, 255-258.

- GMELIG-MEYLING, F. and WALDMANN, T.A. (1981) Human λ -cell activation *in vitro*: augmentation and suppression by monocytes of the immunoglobulin production induced by various B cell stimulants. *J. Immunol.*, 126, 529-537.
- GOEL, K.M., HOUSE, F. and SHANKS, R.A. (1978) Infant feeding practices among immigrants in Glasgow. *Br. med. J.*, 2, 1181-1183.
- GOLDBLUM, R.M., AHLSTEDT, S., CARLSSON, B., HANSON, L.A., JODAL, U., LIDIN-JANSON, G. and SOHL-AKERLUND, A. (1975) Antibody forming cells in human colostrum after oral immunisation. *Nature*, 257, 797-799.
- GOLDMAN, A.S. (1977) Human milk, leucocytes and immunity. *J. Pediatr.*, 90, 167-168.
- GOLDMAN, A.S., GARZA, C., NICHOLS, B.L. and GOLDBLUM, R.M. (1982) Immunologic components in human milk during the first year of lactation. *J. Pediatr.*, 100, 563-567.
- GOLDMAN, A.S. and SMITH, C.W. (1973) Host resistance factors in human milk. *J. Pediatr.*, 82, 1082-1090.
- GOTHEFORS, L. and MARKLUND, S. (1975) Lactoperoxidase activity in human milk and in saliva of newborn infants. *Infect. Immun.*, 11, 1210-1215.
- GOTOFF, S.P. (1974) Neonatal immunity. *J. Pediatr.*, 85, 149-154.
- GOWANS, J.L. (1959) The recirculation of lymphocytes from blood to lymph in the rat. *J. Physiol. (Lond)*, 146, 54-69.
- GOWANS, J.L. and KNIGHT, E.J. (1964) The route of recirculation of lymphocytes in the rat. *Proc. Royal Soc. London B Biol. Sci.*, 159, 257-282.
- GREAVES, M. and JANOSSY, G. (1972) Elicitation of selective T and B lymphocyte responses by cell surface binding ligands. *Transpl. Rev.*, 11, 87-130.
- GROSS, S.J. and BUCKLEY, R.H. (1980) IgA in saliva of breast-fed and bottle-fed infants. *Lancet*, ii, 543.
- GRULEE, C.G., SANFORD, H.N. and HERRON, P.H. (1934) Breast and artificial feeding. Influence on morbidity and mortality of twenty thousand infants. *J. Am. med. Ass.*, 10³, 735-738.
- GUNN, R.A., KIMBALL, A.M., POLLARD, R.A., FEELY, J.C., FELDMAN, R.A., DUTTA, S.R., MATTHEW, P.P., MAHMOOD, R.A. and LEVINE, M.M. (1979) Bottle-feeding as a risk factor for cholera in infants. *Lancet*, 2, 730-732.
- GYORGY, P. (1971) The uniqueness of human milk. *Biochemical aspects. Am. J. clin. Nutr.*, 24, 970-975.
- HAND, L.W. and SMITH, J.W. (1981) Immunology of Enterobacterial infections. In 'Immunology of Human Infection' Eds. A.J.Nahmias and R.J.O'Reilly, Plenum N.Y., 221-247.

- HANEBERG, B. and AARSKOG, D. (1975) Human faecal immunoglobulins in healthy infants and children and in some with diseases affecting the intestinal tract or the immune system. *Clin. exp. Immunol.*, 22, 210-222.
- HANSON, L.A. (1961) Comparative immunological studies on the immune globulins of human milk and of blood serum. *Int. Arch. Allergy*, 18, 241-267.
- HANSON, L.A., AHLSTEDT, S., CARLSSON, B., FALLSTROM, S.P., KAIJSER, B., LINDBLAD, B.S., SOHL-AKERLUND, A. and SVANBORG EDEN, C. (1978) New knowledge in human milk immunoglobulin. *Acta Paediatr. Scand.*, 67, 577-582.
- HANSON, L.A. and BRANDTZAEG, P. (1980) The mucosal defence system. In 'Immunological Disorders in Infants and Children', (Ed. R.E.Stiehm and V.A.Fulginiti) W.B.Saunders Co., London, 137-164.
- HANSON, L.A., CARLSSON, B., AHLSTEDT, S., SVANBORG EDEN, C. and KAIJSER, B. (1975) Immune defense factors in human milk. *Annales Nestle*, 39, 33-42.
- HANSON, L.A. and WINBERG, J. (1972) Breast milk and defence against infection in the newborn. *Arch. Dis. Childh.*, 47, 845-848.
- HARRISON, R.A., LEE, H. and FARRANT, J. (1981) Variability of lymphocyte response to PHA in patients with operable breast carcinoma: effect of cell concentration, PHA dose, serum and period of cultivation. *Clin. Oncology*, 7, 205-212.
- HAWORTH, J.C. and DILLING, L. (1966) Concentrations of gamma-A-globulin in serum, saliva and nasopharyngeal secretions of infants and children. *J. Lab. Clin. Med.*, 67, 922-933.
- HAYWARD, A.R. and LAWTON, A.R. (1977) Induction of plasma cell differentiation of human fetal lymphocytes: evidence for functional immaturity of T and B cells. *J. Immunol.*, 119, 1213-1217.
- HAYWARD, A.R. and LYDYARD, P.M. (1979) B cell function in the newborn. *Pediatrics*, 64, 758-763.
- HEAD, J. (1977) Immunobiology of lactation. *Sem. Perinatol.*, 1, 195-210.
- HEDDLE, R.J., KNOP, J.K., STEELE, E.J. and ROWLEY, D. (1975) The effect of lysozyme on the complement-dependent bactericidal action of different antibody classes. *Immunol.*, 28, 10⁶1.
- HEIRD, W.C. and HANSEN, I.H. (1977) Effect of colostrum on growth of intestinal mucosa. *Pediatr. Res.*, 11, 406.
- HEREMANS, J.P. (1975) The secretory immune system. A critical appraisal. In "The immune system and infectious diseases." 4th Int. Convoc. Immunol., Karger, Basel, 376-385.

- HEREMANS, J.F., HEREMANS, M-TH. and SCHULTZE, H.E. (1959) Isolation and description of a few properties of the β 2A-globulin of human serum. *Clin. Chim. Acta*, 4, 96-102.
- HIRSCHBERG, H., RANKIN, B. and THORSBY, E. (1974) Production of blastogenic factor by mitomycin-treated cells in mixed lymphocyte cultures. *Transplantation*, 17, 323-325.
- HOERLEIN, A.B. (1957) The influence of colostrum on antibody response in baby pigs. *J. Immunol.*, 78, 112-117.
- HOLMES, G.E., HASSANEIN, K.M. and MILLER, H.C. (1983) Factors associated with infections among breast-fed babies and babies fed proprietary milks. *Pediatrics*, 72, 300-306.
- HOLMGREN, J., HANSON, L.A., CARLSSON, B., LINDBLAD, B.S. and RAHIMTOOLA, J. (1976) Neutralising antibodies against *Escherichia coli* and *Vibrio cholerae* enterotoxins in human milk from a developing country. *Scand. J. Immunol.*, 5, 867-872.
- HOLMGREN, J., SVENNERHOLM, A-M. and LINDBLAD, M. (1983) Receptor-like glycoconjugates in human milk that inhibit classical and El Tor *Vibrio cholerae* cell adherence (haemagglutination). *Infect. Immun.*, 39, 147-154.
- HORWITZ, D.A. and GARRETT, M.A. (1977) Distinctive functional properties of human blood L lymphocytes: A comparison with T lymphocytes, B lymphocytes and monocytes. *J. Immunol.*, 118, 1712-1721.
- HUNTER, W.M. and GREENWOOD, F.C. (1962) Preparation of iodine-131 labelled human growth hormone of high specific activity. *Nature*, 194, 495-496.
- HUSBAND, A.J. and GOWANS, J.L. (1978) The origin and antigen-dependent distribution of IgA-containing cells in the intestine. *J. exp. Med.*, 148, 1146-1160.
- HUTCHINS, D. and STEELE, C.M. (1983) Phytohaemagglutinin-induced proliferation of human T lymphocytes: differences between neonates and adults in accessory cell requirements. *Clin. exp. Immunol.*, 52, 355-364.
- IRONSIDE, A.G., TUXFORD, A.F. and HEYWORTH, B. (1970) A survey of infantile gastroenteritis. *Br. med. J.*, 3, 20-24.
- ISCOVE, N.N. and MELCHERS, F. (1978) Complete replacement of serum by albumin, transferrin and soybean lipid in cultures of lipopolysaccharide-reactive B lymphocytes. *J. exp. Med.*, 147, 923-933.
- JACOBS, D.M., ROBERTS, D.B., ELDRIDGE, J.H. and ROSENSPIRE, A.J. (1983) Binding of bacterial lipopolysaccharide to murine lymphocytes. *Ann. N.Y. Acad. Sci.*, 409, 72-80.
- JAKOBSSON, I. and LINDBERG, T. (1978) Cow's milk as a cause of infantile colic in breast-fed infants. *Lancet*, ii, 437-439.

- JANOSSY, G., GOMEZ DE LA CONCHA, E., LUQUETTI, A., SNAJDR, M.J., WAXDAL, M.J. and PLATTS-MILLS, T.A.E. (1977) T-cell regulation of immunoglobulin synthesis and proliferation in pokeweed (Pa-1)-stimulated human lymphocyte cultures. *Scand. J. Immunol.*, 6, 109-123.
- JELLIPPE, D.B. and JELLIPPE, E.F.P. (1978) Technological Urban Societies. In "Human Milk in the Modern World.", Oxford University Press, 182-210.
- JONES, W.R. (1968) *In-vitro* transformation of fetal lymphocytes. *Am. J. Obstet. Gynecol.*, 104, 586-592.
- KAWANISHI, H., SALTZMAN, L.E. and STROBER, W. (1983) Mechanisms regulating IgA class-specific immunoglobulin production in murine gut-associated lymphoid tissues. I. T cells derived from Peyer's patches that switch sIgM B cells *in vitro*. *J. exp. Med.*, 157, 433-450.
- KEIGHTLY, R.K., COOPER, M.D. and LAWTON, A.R. (1976) The T cell dependence of B cell differentiation induced by pokeweed mitogen. *J. Immunol.*, 117, 1538-1544.
- KELLER, M.A., KIDD, R.M., BRYSON, Y.J., TURNER, J.L. and CARTER, J. (1981) Lymphokine production by human milk lymphocytes. *Infect. Immun.*, 32, 632-636.
- KELLER, M.A., KIDD, R.M., LEAKE, R.D. and EVERATT, S.L. (1983) Lymphocyte-derived chemotactic factor production by neonatal lymphocytes. *Pediatr. Res.*, 17, 799-802.
- KENNY, J.F., BOESMAN, M.I. and MICHAELS, R.H. (1967) Bacterial and viral coproantibodies in breast-fed infants. *Pediatrics*, 39, 202-213.
- KIYONO, H., MCGHEE, J.R. and MICHALEK, S.M. (1980) Lipopolysaccharide regulation of the immune response: Comparison of responses to LPS in germ-free, *Escherichia coli*-monoassociated and conventional mice. *J. Immunol.*, 124, 36-41.
- KLAGSBURN, M. (1978) Human milk stimulates DNA synthesis and cellular proliferation in cultured fibroblasts. *Proc. Natl. Acad. Sci. U.S.A.*, 75, 5057-5061.
- KLAGSBURN, M. (1980) Bovine colostrum supports the serum-free proliferation of epithelial cells but not of fibroblasts in long-term culture. *J. cell. Biol.*, 84, 808-814.
- KLAGSBURN, M. and SHING, Y. (1984) Growth-promoting factors in human and bovine milk. In 'Growth and Maturation Factors' Vol. 2, John Wiley and Sons, Inc. N.Y., 161-192.
- KLETTER, B., GERY, I., FREIER, S. and DAVIES, A.M. (1971) Immune responses of normal infants to cow milk. II Decreased immune reactions in initially breast-fed infants. *Int. Arch. Allergy*, 40, 667-674.

- KOHLER, P.F. and PARR, R.S. (1966) Elevation of cord over maternal IgG immunoglobulin: Evidence for an active placental IgG transport. *Nature*, 210, 1070-1071.
- KOSHLAND, M.E. (1975) Structure and function of the J chain. *Adv. Immunol.*, 20, 41-69.
- KUNTZ, M.M., INNES, J.B. and WEKSLER, M.E. (1976) Lymphocyte transformation induced by autologous cells. IV. Human T-lymphocyte proliferation induced by autologous or allogeneic non-T lymphocytes. *J. exp. Med.*, 143, 1042-1054.
- LAGRANGE, P.H., MACKANESS, G.B., MILLER, T.E. and PARDON, P. (1975a) Effects of bacterial lipopolysaccharide on the immune induction and expression of cell mediated immunity. I. Depression of the afferent arc. *J. Immunol.*, 114, 442-446.
- LAGRANGE, P.H., MACKANESS, G.B., MILLER, T.E. and PARDON, P. (1975b) Effects of bacterial lipopolysaccharide on the immune induction and expression of cell mediated immunity. II. Stimulation of the efferent arc. *J. Immunol.*, 114, 447-451.
- LAMM, M.E. (1976) Cellular aspects of immunoglobulin A. *Adv. Immunol.*, 22, 223-290.
- LARSEN, B. and GALASK, R.P. (1977) Protection of the fetus against infection. *Seminars in Perinatology*, 1, 183-193.
- LAWLER, S.D., UKAEJIOFO, E.O. and REEVES, B.R. (1975) Interaction of maternal and neonatal cells in mixed lymphocyte cultures. *Lancet*, ii, 1185-1187.
- LAWTON, A.R. and COOPER, M.D. (1979) B cell ontogeny: Immunoglobulin genes and their expression. *Pediatrics*, 64, 750-757.
- LAWTON, J.W.M. and SHORTRIDGE, K.F. (1977) Protection factors in human breast milk and colostrum. *Lancet*, i, 253.
- LEBENTHAL, E., CLARK, B.A. and KIM, O. (1980) Immunoglobulin concentrations in duodenal fluid of infants and children. *Am. J. Dis. Child.*, 134, 834-837.
- LEIKEN, S. and OPPENHEIM, J.J. (1970) Differences in transformation of adult and newborn lymphocytes stimulated by antigen, antibody and antigen-antibody complexes. *Cell. Immunol.*, 1, 468-475.
- LEISSRING, J.C., ANDERSON, J.W. and SMITH, D.W. (1962) Uptake of antibodies by the intestine of the newborn infant. *Am. J. Dis. Child.*, 103, 160-165.
- LODINOVA, R., JOUJA, V. and WAGNER, V. (1973) Serum immunoglobulins and coproantibody formation in infants after artificial intestinal colonisation with *E.coli* 083 and oral lysozyme administration. *Pediatr. Res.*, 7, 659-669.
- LUCAS, A. and MITCHELL, M.D. (1980) Prostaglandins in human milk. *Arch. Dis. Childh.*, 55, 950-952.

- LUM, L.G., BENVENISTE, E. and BLAESE, R.M. (1980) Functional properties of human T cells bearing Fc receptors for IgA. I. Mitogen responsiveness, mixed lymphocyte culture reactivity and helper activity for B cell immunoglobulin production. *J. Immunol.*, 124, 702-707.
- MARTENSSON, L. and FUDENBERG, H.H. (1965) Gm genes and γ -globulin synthesis in the human fetus. *J. Immunol.*, 94, 514-520.
- MASSON, P.L., HEREMANS, J.F., PRIGNOT, J. and WAUTERS, J. (1966) Immunohistochemical localisation and bacteriostatic properties of an iron-binding protein from bronchial mucus. *Thorax*, 21, 538-544.
- MATA, L.J. and URRUTIA, J.J. (1971) Intestinal colonisation of breast-fed children in a rural area of low socioeconomic level. *Ann. N.Y. Acad. Sci.*, 176, 93-109.
- MCCLELLAND, D.B.L. and McDONALD, T.T. (1976) Antibodies to dietary proteins in human colostrum. *Lancet*, ii, 1251-1252.
- MCCLELLAND, D.B.L., McGRATH, J. and SAMSON, R.R. (1978) Antimicrobial factors in human milk. *Acta Paediatr. Scand.*, Suppl. 271, 1-20.
- MCCLELLAND, D.B.L., SAMSON, R.R., PARKIN, D.M. and SHEARMAN, D.J.C. (1972) Bacterial agglutination studies with secretory IgA prepared from human gastrointestinal secretions and colostrum. *Gut*, 13, 450-458.
- MCDERMOTT, M.R., CLARK, D.A. and BIENENSTOCK, J. (1980) Evidence for a common mucosal immunologic system. II. Influence of the estrus cycle on B immunoblast migration into genital and intestinal tissues. *J. Immunol.*, 124, 2536-2539.
- MCFARLANE, P.I. and MILLER, V. (1984) Human milk in the management of protracted diarrhoea of infancy. *Arch. Dis. Childh.*, 59, 260-265.
- McMURRAY, D.N. and REY, H. (1981) Immunological sequelae of intrauterine infection. *Clin. exp. Immunol.*, 44, 389-395.
- MELLANDER, O., VAHLQUIST, B. and MELLBIN, T. (1959) Breast-feeding and artificial feeding. A clinical, serological and biochemical study in 402 infants with a survey of the literature. The Norbotten Study. *Acta Paediatr.*, 48 (Suppl. 116), 1-108.
- MILLER, M.E. (1980) The immunodeficiencies of immaturity. In "Immunological Disorders of Infants and Children", Eds. R.E. Stiehm and V.A. Fulginiti; W.B. Saunders Co., London, 219-238.
- MILLER, R.A. (1941) Observations on the gastric acidity during the first month of life. *Arch. Dis. Childh.*, 16, 22.
- MIYAGAWA, Y., SUGITA, K., KOMIYAMA, A. and AKABANE, T. (1980) Delayed *in vitro* immunoglobulin production by cord blood lymphocytes. *Pediatrics*, 65, 497-500.

- MOHR, J.A. (1973) The possible induction and/or acquisition of cellular hypersensitivity associated with ingestion of colostrum. *J. Pediatr.*, 82, 1062-1064.
- MONTAZERI, G., CHIORAZZI, N., FU, S.M. and KUNKEL, H.G. (1980) Regulatory role of circulating monocytes in the differentiative and proliferative responses of human B lymphocytes. *Clin. Immunol. Immunopathol.*, 16, 1-10.
- MONTGOMERY, P.C., COHN, J. and LALLY, E.T. (1973) The induction and characterisation of secretory IgA antibodies. *Adv. exp. Med. Biol.*, 45, 453-462.
- MONTREUIL, J., CHOSSON, A., HAVEZ, R. and MULLET, S. (1960) Isolement de β -2A globulines du lait de femme. *C.R.Soc. Biol.*, 154, 732-736.
- MORETTA, L., WEBB, S.R., GROSSI, C.E., LYDYARD, P.M. and COOPER, M.D. (1977) Functional analysis of two human T-cell populations: help and suppression of B-cell responses by T cells bearing receptors for IgM or IgG. *J. exp. Med.*, 146, 184-200.
- MURILLO, G.J. and GOLDMAN, A.S. (1970) The cells of human colostrum. II. Synthesis of IgA and β lc. *Pediatr. Res.*, 4, 71-75.
- NAKAJIMA, S., BABA, A.S. and TAMURA, N. (1977) Complement system in human colostrum. *Int. Arch. Allergy Appl. Immunol.*, 54, 428-433.
- NETER, E., BERTRAM, L.F. and ARBESMAN, C.E. (1952) Demonstration of *Escherichia coli* O55 and O11 antigens by means of haemagglutination test. *Proc. Soc. exp. Biol. Med.*, 79, 255-257.
- NETER, E., WESTPHAL, O., LUDERITZ, O., GINO, R.M. and GORZYNSKI, E.A. (1955) Demonstration of antibodies against enteropathogenic *Escherichia coli* in sera of children of various ages. *Pediatrics*, 16, 801-807.
- NORDBRING, F. (1957) The appearance of antistreptolysin and antistaphylolysin in human colostrum. *Acta Paediatr. (Stockh.)*, 46, 481-496.
- NORTH, M.E. and BRENNER, M.K. (1983) Induction of immunoglobulin and antigen-dependent antibody synthesis in human lymphocytes, using supernatants from mitogen-stimulated cultures. *Immunology*, 48, 157-163.
- NORVAL, M.A. and KENNEDY, R.L.J. (1949) Illness within the first year of life. *J. Pediatr.*, 35, 43-48.
- NUTRITION COMMITTEE OF THE CANADIAN PAEDIATRIC SOC. (1978) Breast-feeding. A commentary in celebration of the Year of the Child, 1979. *Pediatrics*, 62, 591-601.
- O'BRIEN, J., KNIGHT, S.C., QUICK, N.A., MOORE, E.H. and PLATT, A.S. (1979) A simple technique for harvesting lymphocytes cultured in Terasaki plates. *J. Imm. Methods*, 27, 219-223.

- OGRA, P.L. (1979) Ontogeny of the local immune system. *Pediatrics*, 64, 774 (discussion).
- OGRA, S.S., WEINTRAUB, D. and OGRA, P.L. (1977) Immunologic aspects of human colostrum and milk. III Fate and absorption of cellular and soluble components in the gastrointestinal tract of the newborn. *J. Immunol.*, 119, 245-248.
- OGRA, S.S., WEINTRAUB, D.I. and OGRA, P.L. (1978) Immunologic aspects of human colostrum and milk: interaction with the intestinal immunity of the neonate. *Adv. exp. Med. Biol.*, 107, 95-107.
- ORLANS, E., PEPPARD, J., REYNOLDS, J. and HALL, J. (1978) Rapid active transport of immunoglobulin A from blood to bile. *J. exp. Med.*, 147, 588-590.
- OTTAWAY, C.A., ROSE, M.L. and PARROTT, D.M.F. (1979) The gut as an immunological system. in "International Review of Physiology. Gastrointestinal Physiology III" Vol. 19, Ed. R.K. Crane, University Press, Baltimore., 323-356.
- PARMELY, M.J., BEER, A.E. and BILLINGHAM, R.E. (1976) *In vitro* studies on the T-lymphocyte population of human milk. *J. exp. Med.*, 144, 358-370.
- PARMELY, M.J., REATH, D.B., BEER, A.E. and BILLINGHAM, R.E. (1977) Cellular immune responses of human milk T lymphocytes to certain environmental antigens. *J. exp. Med.*, 144, 358-370.
- PARROT, D.M.V. (1979) Source, identity and locomotor characteristics of lymphocyte populations migrating to mammary glands: Problems and predictions. In "Immunology of Breast Milk", Ed. P.L. Ogra and D. Dayton, Raven Press, N.Y., 131-141.
- PEPPARD, J., ORLANS, E., PAYNE, A.W.R. and ANDREW, E. (1981) The elimination of circulating complexes containing polymeric IgA by excretion in the bile. *Immunol.*, 42, 83-89.
- PETERSON, J.C. and CHRISTIE, A. (1951) Immunization of the young infant. *Am. J. Dis. Child.*, 81, 483-529.
- PIERCE, N.F. and GOWANS, J.L. (1975) Cellular kinetics of the intestinal immune response to cholera toxoid in rats. *J. exp. Med.*, 142, 1550-1563.
- PIERCE-CRETEL, A., PAMBLANCO, M., STRECKER, G., MONTREUIL, J. and SPIK, G. (1981) Heterogeneity of the glycans O-glycosidically linked to the hinge region of secretory immunoglobulins of human milk. *Eur. J. Biochem.*, 114, 169-178.
- PITT, J., BARLOW, B. and HEIRD, W.C. (1977) Protection against experimental necrotizing enterocolitis by maternal milk. I. Role of milk leukocytes. *Pediatr. Res.*, 11, 906-909.
- PITTARD III, W.B. and BILL, K. (1979a) Immunoregulation by breast milk cells. *Cell. Immunol.*, 42, 437-441.

- PITTARD III, W.B. and BILL, K. (1979b) Differentiation of cord blood lymphocytes into IgA-producing cells in response to breast milk stimulatory factor. *Clin. Immunol. Immunopathol.*, 13, 430-434.
- PITTARD III, W.B., MILLER, K. and SORENSEN, R.U. (1984) Normal lymphocyte responses to mitogens in term and preterm neonates following normal and abnormal intrauterine growth. *Clin. Immunol. Immunopathol.*, 30, 178-187.
- PITTARD III, W.B., POLMAR, S.H. and FANAROFF, A.A. (1977) The breast milk macrophage: a potential vehicle for immunoglobulin transport. *J. Reticuloendothel. Soc.*, 22, 597-603.
- PLANK, S.J. and MILANESI, M.L. (1973) Infant feeding and infant mortality in rural Chile. *Bull. W.H.O.*, 48, 203-210.
- PRYJMA, J., MUNOZ, J., GALBRAITH, R.M., FUDENBERG, H.H. and VIRELLA, G. (1980) Induction and suppression of immunoglobulin synthesis in cultures of human lymphocytes: Effects of pokeweed mitogen and *Staphylococcus aureus* Cowan I. *J. Immunol.*, 124, 656-661.
- PULLAN, C.R., TOMS, G.L., MARTIN, A.J., GARDNER, P.S., WEBB, J.K.G. and APPLETON, D.R. (1980) Breast-feeding and Respiratory Syncytial virus infection. *Br. med. J.*, 2, 1034-1036.
- RASMUSSEN, N.H. and RASMUSSEN, L.M. (1982) Predictive value of white blood cell count and differential cell count to bacterial infections in children. *Acta Paediatr. Scand.*, 71, 775-778.
- READ, L.C., UPTON, F.M., FRANCIS, G.L., WALLACE, J.C., DAHLENBERG, G.W. and BALLARD, F.J. (1984) Changes in the growth-promoting activity of human milk during lactation. *Pediatr. Res.*, 18, 133-139.
- REINHERZ, E.L., MORIMOTO, C., PENTA, A.C. and SCHLOSSMAN, S.F. (1981) Subpopulations of the T4+ inducer T cell subset in man: Evidence for an amplifier population preferentially expressing Ia antigen upon activation. *J. Immunol.*, 126, 67-70.
- REITER, B. (1978) Review of non-specific antimicrobial factors in colostrum. *Ann. Rech. Vet.*, 9, 205-224.
- REITER, B., PICKERING, A., ORAM, J.D. and POPE, G.S. (1963) Peroxidase-thiocyanate inhibition of Streptococci in raw milk. *J. gen. Micro.*, 33, xii.
- REMINGTON, J.S., VOSTI, K.L., LIETZE, A. and ZIMMERMAN, A.L. (1964) Serum proteins and antibody activity in human nasal secretions. *J. Clin. Invest.*, 43, 1613-1624.
- RESMAN, B.H., BLUMENTHAL, H.P. and JUSKO, W.J. (1977) Breast milk distribution of theobromine from chocolate. *J. Pediatr.*, 91, 477-480.
- RETHY, L. (1983) Immunomodulant activity of endotoxins in man. *Annales Immunologiae Hungaricae*, 23, 15-53.

- RICH, R.R. and PIERCE, C.W. (1973) Biological expressions of lymphocyte activation. I. Effects of phyto mitogens on antibody synthesis *in vitro*. *J. exp. Med.*, 137, 205-223.
- ROBBINS, J.B., KENNY, K. and SUTER, E. (1965) The isolation and biological activities of rabbit γ M- and γ G-anti-Salmonella typhimurium antibodies. *J. exp. Med.*, 122, 385-402.
- ROBERTS, S.A. and FREED, D.L.J. (1977) Neonatal IgA secretion enhanced by breast feeding. *Lancet*, ii, 1131.
- ROBERTS, S.A., WINCUP, G. and HARRIES, D.A. (1980) Mucosal receptor for IgA in the breast-fed neonate. *Early Human Development*, 4, 161-166.
- ROBINSON, M. (1951) Infant morbidity and mortality. A study of 3266 infants. *Lancet*, i, 788-794.
- ROGERS, H.J. and SYNGE, C. (1978) Bacteriostatic effect of human milk on *Escherichia coli*: the role of IgA. *Immunology*, 34, 19-28.
- ROSS, C.A.C. and DAVES, E.A. (1954) Resistance of the breast-fed infant to gastroenteritis. *Lancet*, i, 994-998.
- ROUX, M.E., McWILLIAMS, M., LAMM, M.E. and PHILLIPS-QUAGLIATA, J.M. (1979) Site of maturation of IgA plasma cell precursors. *Fed. Proc.*, 38, 1081.
- ROUX, M.E., McWILLIAMS, M., PHILLIPS-QUAGLIATA, J.M., WEISZ-CARRINGTON, P. and LAMM, M.E. (1977) Origin of IgA-secreting plasma cells in the mammary gland. *J. exp. Med.*, 146, 1311-1322.
- RUSCH, V., HYDE, R.M. and LUCKEY, T.D. (1983) Applications of *S. faecalis* and *E. coli* oral vaccines in humans and animals. *Prog. Fd. Nutr. Sci.*, 7, 39-52.
- RUTTER, J.M., JONES, G.W., BROWN, G.T.H., BURROWS, M.R. and LUTHER, P.D. (1976) Anti-bacterial activity in colostrum and milk associated with protection of piglets against enteric disease caused by K88-positive *Escherichia coli*. *Infect. Immun.*, 13, 667-676.
- RUUSKANEN, O., PITTARD III, W.B., SORENSEN, R.U. and POLMAR, S.H. (1980) Lymphocyte stimulation assay utilizing newborn heel skin puncture blood samples. *J. Clin. Lab. Immunol.*, 4, 111-114.
- SAARINEN, U.M., KAJOSAARI, M., BACKMAN, A. and SIIMES, M.A. (1979) Prolonged breast-feeding as prophylaxis for atopic disease. *Lancet*, ii, 163-166.
- SAARINEN, U.M., PELKONEN, P. and SIIMES, M.A. (1979) Serum immunoglobulin A in healthy infants: An accelerated postnatal increase in formula-fed compared to breast-fed infants. *J. Pediatr.*, 95, 410-412.
- SAGIE, E., TARABULUS, J., MAEIR, D.M. and PREIER, S. (1974) Diet and development of intestinal IgA in the mouse. *Israel J. Med. Sci.*, 10, 532-534.

- SAVILAHTI, E., JARVENPAA, A-L. and RAIHA, N.C.R. (1983) Serum immunoglobulins in preterm infants: comparison of human milk and formula feeding. *Pediatrics*, 72, 312-316.
- SCHLESINGER, J.J. and COVELLI, H.D. (1977) Evidence for transmission of lymphocyte responses to tuberculin by breast-feeding. *Lancet*, ii, 529-532.
- SCHUIT, K.E. and POWELL, D.A. (1980) Phagocytic dysfunction in monocytes of normal newborn infants. *Pediatrics*, 65, 501-504.
- SCHWARTZ, S. and HEIRD, W.C. (1981) Further studies of colostrum-stimulated enteric mucosal growth. *Pediatr. Res.*, 15, 546.
- SELNER, J.C., MERRILL, D.A. and CLAMAN, H.N. (1968) Salivary immunoglobulin and albumin: Development during the neonatal period. *J. Pediatr.*, 72, 685-689.
- SHANKEY, T.V., DANIELE, R.P. and NOWELL, P.C. (1981) Kinetics of mitogen-induced proliferation and differentiation of human peripheral blood B lymphocytes. *Clin. exp. Immunol.*, 44, 156-166.
- SHEARMAN, D.J.C., PARKIN, D.M. and McCLELLAND, D.B.L. (1972) The demonstration and function of antibodies in the gastrointestinal tract. *Gut*, 13, 483-499.
- SHUKLA, G.K. (1973) Some exact tests of hypotheses about Grubbs's estimators. *Biometrics*, 29, 373-377.
- SKOGH, T., EDEBO, L. and STENDAHL, O. (1983) Gastrointestinal uptake and blood clearance of antigen in the presence of IgA antibodies. *Immunol.*, 50, 175-180.
- SMELLIE, J.M. (1939) Infantile diarrhoea. *Lancet*, i, 969-973.
- SMITH, C.W. and GOLDMAN, A.S. (1968) The cells of human colostrum. I. *In-vitro* studies of morphology and function. *Pediatr. Res.*, 2, 103-109.
- SMITH, C.W. and GOLDMAN, A.S. (1970) Interactions of lymphocytes and macrophages from human colostrum. *J. Reticuloendothel. Soc.*, 8, 91-104.
- SOHL-AKERLUND, A., AHLSTEDT, S., HANSON, L.A. and JODAL, U. (1979) Antibody responses in urine and serum against *Escherichia coli* O antigen in childhood urinary tract infection. *Acta Path. Microbiol. Scand. Sect. C*, 87, 29-36.
- SPENCE, J.C. (1938) The modern decline of breast-feeding. *Br. med. J.*, 2, 729-733.
- SPIK, G., CHERON, A., MONTREUIL, J. and DOLBY, J.M. (1978) Bacteriostasis of a milk-sensitive strain of *Escherichia coli* by immunoglobulins and iron-binding proteins in association. *Immunology*, 35, 663-671.

- STE-MARIE, M.T., LEE, E.M. and BROWN, W.R. (1974)
Radioimmunologic measurements of naturally occurring antibodies: III. Antibodies reactive with *Escherichia coli* or *Bacteroides fragilis* in breast fluids and sera of mothers and newborn infants. *Pediatr. Res.*, 8, 815-819.
- STEPHENS, S., DOLBY, J.M., MONTREUIL, J. and SPIK, G. (1981)
Differences in inhibition of the growth of commensal and enteropathogenic strains of *Escherichia coli* by lactotransferrin and secretory immunoglobulin A isolated from human milk. *Immunol.*, 41, 597-603.
- STEPHENS, S., HARKNESS, R.A. and COCKLE, S.M. (1979)
Lactoperoxidase activity in guinea-pig milk and saliva: correlation in milk of lactoperoxidase with bactericidal activity against *Escherichia coli*. *Br. J. exp. Pathol.*, 60, 252-258.
- STEVENSON, S.S. (1947) The adequacy of artificial feeding in infancy. *J. Pediatr.*, 31, 616-630.
- STEWART, A. and WESTROPP, C. (1953) Breast-feeding in the Oxford Child Health Survey. Part II- Comparison of bottle- and breast-fed babies. *Br. med. J.*, 2, 305-308.
- STIEHM, E.R. and FUDENBERG, H.H. (1966) Serum levels of immune globulins in health and disease: A survey. *Pediatrics*, 37, 715-727.
- STIEHM, E.R., WINTER, H.S. and BRYSON, Y.J. (1979) Cellular (T cell) immunity in the human newborn. *Pediatrics*, 64, 814-821.
- STITES, D.P. and PAVIA, C.S. (1979) Ontogeny of human T cells. *Pediatrics*, 64, 795-801.
- STITES, D.P., WYBRAN, J., CARR, M.C. and FUDENBERG, H.H. (1972) Development of cellular immunocompetence in man. In 'Ontogeny of Acquired Immunity', Ciba Foundation Symposium, 113-128.
- STOLIAR, O.A., PELLELY, R.P., KANIEKI-GREEN, E., KLAUS, M.H. and CARPENTER, C.C.J. (1976) Secretory IgA against enterotoxins in breast milk. *Lancet*, i, 1258-1261.
- SUSSMAN, G.D. (1977) The end of the wet-nursing business in France, 1874-1914. *J. Family History*, 2, 237-258.
- SVANBORG EDEN, C., CARLSSON, B., HANSON, L.A., JANN, B., JANN, K., KORHONEN, T. and WADSTROM, T. (1979) Anti-pili antibodies in breast milk. *Lancet*, ii, 1235.
- SVIRSKY-GROSS, S. (1958) Pathogenic strains of Coli (O,111) among prematures and the use of human milk in controlling the outbreak of diarrhoea. *Ann. Paediatr.*, 190, 109-115.
- TAPPER, D., KLAGSBURN, M. and NEUMAN, J. (1979) The identification and clinical implications of human breast milk mitogen. *J. Pediatric Surgery*, 14, 803-808.

- TASSOVATZ, B. and KOTSITCH, A. (1961) Le lait de femme et son action de protection contra les infections intestinales chez le nouveaune. *Ann. Paediatr.*, 8, 285-288.
- TAYLOR, B., NORMAN, A.P., ORGEL, H.A., STOKES, C.R., TURNER, M.W. and SOOTHILL, J.F. (1973) Transient IgA deficiency and pathogenesis of infantile atopy. *Lancet*, ii, 111.
- TAYLOR, B., WADSWORTH, J., GOLDRING, J. and BUTLER, N. (1982) Breast-feeding, bronchitis and admission for lower-respiratory illness and gastroenteritis during the first five years. *Lancet*, i, 1227-1229.
- TAYLOR, S. and BRYSON, Y. (1981) Impaired production of immune (PHA-induced) interferon in newborns is due to a functionally immature macrophage. *Pediatr. Res.*, 15, 604.
- THOMAS, R.M. and LINCH, D.C. (1983) Identification of lymphocyte subsets in the newborn using a variety of monoclonal antibodies. *Arch. Dis. Childh.*, 58, 34-38.
- TLASKALOVA-HOGENOVA, H., STERZL, J., STEPANKOVA, R., DLABAC, V., VETVICKA, V., ROSSMANN, P., MANDEL, L. and REJNEK, J. (1983) Development of immunological capacity under germfree and conventional conditions. *Ann. N.Y. Acad. Sci.*, 409, 96-113.
- TOIVANEN, P. and GRANBERG, C. (1980) Mother/child mixed lymphocyte reaction: is it depressed? *Immunol. Today*, 1, 76-78.
- TOLO, K., BRANDTZAEG, P. and JONSEN, J. (1977) Mucosal penetration of antigen in the presence or absence of serum-derived antibody. An *in vitro* study of rabbit oral and intestinal mucosa. *Immunology*, 33, 733-743.
- TOMASI, T.B., TAN, E.M., SOLOMON, A. and PRENDERGAST, R.A. (1965) Characteristics of an immune system common to certain external secretions. *J. exp. Med.*, 121, 101-124.
- TREVES, A.J., BARAK, V. and FUKS, Z. (1980) Characterization of human lymphocytes which proliferate 'spontaneously' *in vitro*. *Eur. J. Immunol.*, 10, 883-887.
- UDALL, J.N., COLONY, P., FRITZE, L., PANG, K., TRIER, J.S. and WALKER, W.A. (1981) Development of gastrointestinal mucosal barrier. II. The effect of natural versus artificial feeding on intestinal permeability to macromolecules. *Pediatr. Res.*, 15, 245-249.
- UNANDER, A.M., HAMMARSTROM, L. and SMITH, C.I.E. (1983) Functional maturity of cord blood B lymphocytes: *Staphylococcus aureus* Cowan I induces IgG secretion in the human neonate. *Clin. exp. Immunol.*, 53, 703-708.
- VAHLQUIST, B. (1958) The transfer of antibodies from mother to offspring. *Adv. Pediatr.*, 10, 305-338.

- VAN DER WAAIJ, D. and HEIDT, P.J. (1977) Intestinal bacterial ecology in relation to immunological factors and to other defence mechanisms. in "Food and Immunology", Swedish Nutrition Foundation Symposium, 133-141.
- WADA, N., NISHIDA, N., INAKI, S., OHI, H., MIYANAKI, T., TANIGUCHI, N. and MIGITA, S. (1980) Neutralising activity against *Clostridium difficile* toxin in the supernatants of cultured colostrals cells. *Infect. Immun.*, 29, 545-550.
- WALDMANN, T.A. and BRODER, S. (1982) Polyclonal B-cell activators in the study of the regulation of immunoglobulin synthesis in the human system. *Adv. Immunol.*, 32, 1-63.
- WALKER, W.A. (1977) Development of intestinal host defence mechanisms and the passive protective role of human milk. Mead Johnson Symposium on Perinatal and Developmental Medicine., 11, 39-48.
- WARA, D.W. and BARRETT, D.J. (1979) Cell-mediated immunity in the newborn: Clinical aspects. *Pediatrics*, 64 (Suppl.), 822-826.
- WARDLAW, A.C. (1962) The complement-dependent bacteriolytic activity of normal human serum. *J. exp. Med.*, 115, 1231-1249.
- WATKINS, C.J., LEEDER, S.R. and CORKHILL, R.T. (1979) The relationship between breast and bottle feeding and respiratory illness in the first year of life. *J. Epidemiol. Commun. Hlth.*, 33, 180-182.
- WEAVER, E.A., TSUDA, H., GOLDBLUM, R.M., GOLDMAN, A.S. and DAVIS, C.P. (1982) Relationship between phagocytosis and immunoglobulin A release from human colostrals macrophages. *Infect. Immun.*, 38, 1073-1077.
- WEBER, T.H., SANTESSON, B. and SKOOG, V.T. (1973) The activation of fetal lymphocytes. *Scand. J. Haematol.*, 11, 177-183.
- WEISZ-CARRINGTON, P., ROUX, M.E., McWILLIAMS, M., PHILLIPS-QUAGLIATA, J.M. and LAMM, M.E. (1978) Hormonal induction of the secretory immune system in the mammary gland. *Proc. Natl. Acad. Sci.*, 75, 2928-2932.
- WELLIVER, R.C. and OGRA, P.L. (1978) Importance of local immunity in enteric infections. *J. Am. Vet. Med. Assoc.*, 173, 560-564.
- WELSH, J.K. and MAY, J.T. (1979) Anti-infective properties of breast milk. *J. Pediatr.*, 94, 1-9.
- WHARTON, B. (1982) A quinquennium in infant feeding. *Arch. Dis. Childh.*, 57, 895-897.
- WHORWELL, P.J., HOLDSTOCK, G., WHORNELL, G.M. and WRIGHT, R. (1979) Bottle feeding and early gastroenteritis and inflammatory bowel disease. *Br. med. J.*, 1, 382.
- WIENER, A.S. (1951) The half-life of passively acquired antibody globulin molecules in infants. *J. exp. Med.*, 94, 213-221.

- WILLIAMS, R.C. and GIBBONS, R.J. (1972) Inhibition of bacterial adherence by secretory immunoglobulin A: a mechanism of antigen disposal. *Science*, 177, 697-699.
- WILLIAMS, R.C. and GIBBONS, R.J. (1975) Inhibition of Streptococcal attachment to receptors of human buccal epithelial cells by antigenically similar salivary glycoproteins. *Infect. Immun.*, 11, 711-718.
- WINBERG, J. and WESSNER, G. (1971) Does breast milk protect against septicaemia in the newborn? *Lancet*, i, 1091-1094.
- WINER, B.J. (1971) *Statistical principles in experimental design*. McGraw-Hill, Kogakusha, Tokyo, 514-559.
- WINTER, H.S., BRYSON, Y.J., GARD, S.E., FISCHER, T.J. and STIEHM, E.R. (1978) Deficiency of monocyte migration inhibition factor and immune interferon production in lymphocytes of normal newborns. *Pediatr. Res.*, 12, 488.
- WU, L.Y.F., BLANCO, A., COOPER, M.D. and LANTON, A.R. (1976) Ontogeny of B-lymphocyte differentiation induced by pokeweed mitogen. *Clin. Immunol. Immunopathol.*, 5, 208-217.
- YAP, P.L., PRYDE, A., LATHAM, P.J. and MCLELLAND, D.B.L. (1979) Serum IgA in the neonate. Molecular size, concentration and effect of breast-feeding. *Acta Paediatr. Scand.*, 68, 695-700.
- YENGAR, L. and SELVARAJ, R.J. (1972) Intestinal absorption of immunoglobulins by newborn infants. *Arch. Dis. Childh.*, 47, 411-414.
- YOPPEY, J.M., RON, A., PRINDULL, G. and YAFFE, P. (1978) Earlier onset of DNA synthesis in mitogen-stimulated lymphocytes of cord blood than in lymphocytes of adult blood. *Clin. Immunol. Immunopathol.*, 9, 491-498.
- ZLABINGER, G.J., MANNHALTER, J.W. and EIBL, M.M. (1983) Cord blood macrophages present bacterial antigen (*Escherichia coli*) to paternal T cells. *Clin. Immunol. Immunopathol.*, 28, 405-412.
- ZOPPI, G., CASPARINI, R., MANTOVANELLI, F., GOBIO-CASALI, L., ASTOLFI, R. and CROVARI, P. (1983) Diet and antibody response to vaccination in healthy infants. *Lancet*, ii, 11-14.

APPENDIX

COMPOSITION OF INFANT FEEDS (per 100ml)

	HUMAN	SMA	OSTERMILK	COW AND GATE
PROTEIN g	1.2	1.5	1.8	2.4
FAT g	3.8	3.6	3.0	1.9
CARBOHYDRATE g	7.0	7.2	9.3	7.0
Na mg	15	15	45	41
K "	55	55	83	104
Cl "	43	41	68	-
Ca "	33	42	60	84
Mg "	4	4	6.2	8.9
P "	15	33	50	65
Fe "	0.15	0.8	1.0	0.5
Cu µg	40	40	-	12.6
Zn mg	0.4	0.3	-	0.2
Na meq/l	6.5	6.5	19.6	17.8
K "	14.1	14.1	21.2	26.6
Cl "	12.1	11.5	19.0	-
Vit A µg	58	80	105	100
Vit C mg	4.3	5.3	7.0	3.5
Vit D µg	0.01	1.1	1.0	1.1

Values from DHSS report, 1974