

PICASO  
A  
COMPUTER LANGUAGE  
FOR  
ART & DESIGN

by

J A Vince

1975

BRUNEL UNIVERSITY

## ABSTRACT

PICASO is a computer language specifically designed to enable the artist/designer to use the digital computer as a graphic tool.

It is a unique development in that it provides the artist for the first time, an integrated range of sophisticated graphic software in a format meaningful to the non-numerate user.

This thesis examines the problem area of art and design, and reviews relevant computer software that is currently available. It continues to define the software requirements of the artist and designer, and illustrates how these are met by PICASO.

	<u>CONTENTS</u>	<u>PAGE</u>
1	<u>INTRODUCTION</u>	1
2	<u>STATEMENT OF THE PROBLEM</u>	3
	2.1 COMPUTER ART	
	2.2 THE GROWTH OF COMPUTER ART	
	2.3 THE PRESENT PROBLEM	
3	<u>STATE OF THE ART</u>	8
	3.1 COMPUTER GRAPHICS IN EDUCATION	
	3.2 COMPUTER GRAPHICS IN ART & DESIGN	
4	<u>COMPUTER ART SOFTWARE REQUIREMENTS</u>	10
	4.1 LANGUAGE TYPE	
	4.2 LANGUAGE PHILOSOPHY	
	4.3 EXISTING SOFTWARE	
5	<u>PICASO</u>	20
	5.1 DESIGN PHILOSOPHY	
	5.2 SYSTEM STRUCTURE	
	5.3 LANGUAGE SYNTAX AND SEMANTICS	
	5.4 PICASO SPATIAL CONVENTIONS	
	5.5 PICASO STRUCTURES	
	5.6 STRUCTURE MANIPULATION	
	5.7 PICASO DRAWING COMMANDS	
	5.8 PICASO STRUCTURE ANALYSIS COMMANDS	
	5.9 PICASO SURFACES	
	5.10 PICASO SPECIAL EFFECTS	
	5.11 PICASO FUNCTIONS	
	5.12 PICASO ARRAY HANDLING COMMANDS	

	<u>PAGE</u>
6	71
<u>PICASO EXAMPLES</u>	
6.1	EXAMPLE OF THE 2-D LIBRARY
6.2	EXAMPLE OF THE 3-D LIBRARY
6.3	SHAPE MANIPULATION
6.4	SURFACES
6.5	SPECIAL EFFECTS
6.6	VARIOUS EXAMPLES
7	89
<u>APPLICATION AREAS FOR PICASO</u>	
7.1	ART & DESIGN
7.2	MATHEMATICS
7.3	ENGINEERING
8	95
<u>CONCLUSIONS</u>	
9	98
<u>APPENDICES</u>	
9.1	SUMMARY OF PICASO SYSTEM COMMANDS
9.2	SUMMARY OF PICASO INPUT/OUTPUT COMMANDS
9.3	SUMMARY OF PICASO SHAPES
9.4	SUMMARY OF PICASO OBJECTS
9.5	SUMMARY OF PICASO STRUCTURE MANIPULATING COMMANDS
9.6	SUMMARY OF PICASO PLOTTING COMMANDS
9.7	SUMMARY OF PICASO STRUCTURE ANALYSIS COMMANDS
9.8	SUMMARY OF PICASO FUNCTIONS
9.9	SUMMARY OF SPECIAL EFFECTS
9.10	SUMMARY OF ARRAY HANDLING COMMANDS

9.11	SUMMARY OF PICASO SURFACE COMMANDS	
9.12	PICASO DATA STRUCTURE	
9.13	WINDOWING ALGORITHM	
9.14	ISOMET ALGORITHM	
10	<u>REFERENCES</u>	120
11	<u>PICASO USER MANUAL</u>	122

## 1 INTRODUCTION

There has never been a deliberate attempt to create and develop computer art, its existence and evolution has always been unstable and uncontrolled which has accounted for considerable waste of effort and time in rediscovering well established graphic concepts. Consequently, artists working with computers have a serious communication handicap in that there is not available a universal language to interface the artist to the computer, which requires them to master unsuitable programming languages to achieve relatively primitive graphic effects.

PICASO is a modular structured language developed by the author for the artist or designer, enabling him to manipulate real and abstract graphic concepts without the burden of advanced programming. PICASO has also been designed to work with a small digital computer with the minimum of graphic hardware, namely a graph plotter, and yet produce sophisticated graphic output.

The creation of PICASO is the result of several years research by the author into computer graphics to discover and establish the important problem areas encountered by the novice, and its development has been influenced considerably by the opinions of artists working with computers.

## 1 INTRODUCTION Continued.

This thesis describes the problems encountered by computer artists and how PICASO offers a real and original contribution to the development of computer graphics in the areas of art and design.

## 2 STATEMENT OF THE PROBLEM

### 2.1 COMPUTER ART

Computer art is an art form that has emerged over the past two decades involving the digital computer and graphic peripherals to express graphic ideas. The art form is unique in that it permits the artist to explore techniques that were avoided due to the time and skills required, and also provides a vast source of graphic effects that are unique to the computer.

The earliest forms of computer art consisted of generating pictures on a line printer to create images from patterns of characters and over-printing them to create shading. Obviously, this had limited applications but was a first step to realising the potential of the computer as a graphic tool.

The development of the digital plotter and the graphic display provided two important tools for the artist, as these permitted the creation of simple line drawings. However, the control of these ideas demanded a programming expertise that is not common among artists. This severe user restriction has inhibited the growth of computer art as a universally available art form.



## 2.2 THE GROWTH OF COMPUTER ART

As early as 1960, the Boeing Company were using the computer to draw three-dimensional human figures to assist designers in the ergonomics of cockpit design, and since this pioneer work computer graphics has continued to play a major role in computer aided design. Computer art however, emerged in the wake of computer graphics exploiting software primarily designed for engineers to the advantage of the artist.

The lack of specific software at this time severely restricted the growth of computer art, as it has been estimated that in 1971 no more than 1000 researchers were working on computer art in the entire world.<sup>(1)</sup>

Even today in 1975 there is still a real problem with the availability of software, whilst one institution might have access to advanced graphic hardware and the latest software, another might not be beyond the stage of reproducing simple geometric patterns on a graph plotter. So the problem with growth is not just a question of rate, but that it has not been geographically uniform.

### 2.3 THE PRESENT PROBLEM

Investigations have shown that the majority of computers in educational establishments with graphic equipment are not exploiting the full capability of this equipment, due to the limited software available. This situation is so serious that immediate steps have been taken to organise at a national level the acquisition of graphic software, and the redistribution to educational users.<sup>(2)</sup> Therefore the present problems are the lack of general graphic software at a global level and specifically software for the artist/designer.

It is incorrect to believe that there is a total absence of graphic software, obviously it must and does exist, but it tends to fall into various categories.

#### Machine dependent software

It is not always possible to design software to be independent of hardware, for example a language like SPROGS<sup>(3)</sup> has been specifically designed to operate a SD4020 microfilm recorder, but there is software available that is machine dependent from the aspects of core requirement and compiler availability. Often one can attempt to implement algorithms developed on large machines, only to discover that the programmer made no attempt to conserve core space, with the result that the user with a small or medium size computer is unable to use the program. There exists also other software that requires associated programming languages such as PL1<sup>(4)</sup> and APL<sup>(5)</sup>, languages that are still not universally

available.

### Specialist software

The nature of computer graphics is such that it is not, and probably will not be supported in the near future by a universal language; this has resulted in the use of existing languages and the development of specialist graphic languages to cope with individual problem areas.

(6) MULTIPATCH a language for interactive design and COMPAX (7) a language for scene analysis are totally different in structure, syntax and application, but they are both useful graphic languages. This specialisation of languages presents a problem to the user investigating several problem areas simultaneously, but is of little assistance to the artist/designer who is unable to define the extent of his problem area.

### Expensive software

All software is expensive, and Licklider's article in (8) 1969 'A Picture is Worth a Thousand Words- and It Costs' still holds true today.

(9) The DISSPLA package is probably one of the most sophisticated graphic software systems available. It is machine and device independent, implemented in FORTRAN, works in two and three dimensions with or without hidden-line removal, but as one can appreciate it has a correspondingly high outright purchase price. The educational user might require DISSPLA's features, but could not afford them.

Here then is the dilemma. On one hand the artist needs graphic software, and on the other, software is available but is either too expensive, unproven, unsuitable, too specialised or machine dependent.

In spite of these limitations, computer art has managed to survive and grow into a world-wide activity, and has had considerable influence on art and design.

### 3 STATE OF THE ART

#### 3.1 COMPUTER GRAPHICS IN EDUCATION

With the advent of mini-computer graphic systems, computer graphics is now within the budget of many educational institutions. It has already influenced many areas of education, and it is difficult to isolate one subject that has remained untouched.

The author's personal work alone has involved him in civil engineering, electrical engineering, control-engineering, music, mathematics, fine art, and graphic design. Unfortunately this influence has been local rather than global, and has created privileged areas of activity where there exists adequate expertise, but many under privileged areas where there is a desire to enjoy the same facilities, but no expertise available.

#### 3.2 COMPUTER GRAPHICS IN ART & DESIGN

Computer graphics finds its way into art and design through courses like DipAD in Fine Art, Graphic Design and Interior Design. The course content depends entirely upon the graphics system implemented, and consequently varies considerably. This is an unfortunate state of affairs, but little can be done until the software aspect is formalized.

In the author's experience, computers can produce a wide variety of responses from art students, ranging

from a total rejection to complete absorption in computer techniques, neither of which is totally healthy. An initial reaction is to regard the computer as totally non-creative, which is true in some respects, but difficult to prove until the student has had a chance to experience using the machine. At first, the whole concept of using computers in the area of art appears foreign, but students who study the subject with an open mind discover that there is a real place for the computer.

A good graphics system can teach art students many things about their own subject. It can help formalize many abstract concepts concerning space, symmetry, perspective etc., and even provide a completely new insight into shapes and objects and their topological properties.

There will always be students who remain unconvinced about the use of computer techniques in art, and perhaps the image of the computer together with unsuitable software, has a lot to answer for in this context. Perhaps the next generation of software will assist in providing greater cohesion in this entire subject area.

## 4 SOFTWARE REQUIREMENTS FOR ART & DESIGN

### 4.1 LANGUAGE TYPE

The most popular language for implementing graphic programs is FORTRAN, as it provides features for expressing mathematical ideas that can directly represent graphic concepts. However, for an artist the use of FORTRAN creates two major problems; the first is learning FORTRAN, and the second is the acquisition of programming techniques such as data structure handling, algorithms, and possibly vector analysis, coordinate geometry, topology and matrix theory. The author has actually taught FORTRAN to artists and discovered from first-hand experience the conceptual problems this language poses to the artistic intellect.

The artist obviously requires a language that handles directly graphic concepts, and therefore calls for a special language. Although many languages have been developed there is not one that has managed to acquire the status of a language like FORTRAN or ALGOL. Some of these existing languages are described in Section 4.3.

### 4.2 LANGUAGE PHILOSOPHY

The majority of problem-oriented languages enable a user to identify system elements, groups, procedures and operations with names familiar and relevant to the user. Therefore any graphics language must be capable of handling ideas such as space, form,

movement, texture and colour etc, in a way that is natural for the artist. He must be able to express his thoughts in a notation that will not hide the meaning of his ideas. The following features are considered essential requirements for such a language.

#### 4.2.1 SPACE

The language must permit the user to handle two and three-dimensional spaces so that 3-D objects may be manipulated together with 2-D shapes with equal ease.

#### 4.2.2 FORM

The data structure handling shapes and objects should enable essential features of form to be controlled such as: vertices, surfaces, visibility, size, displacement etc..

#### 4.2.3 VIEWPOINT

A two-dimensional space presents no unusual problems regarding a viewpoint, however, three-dimensional systems must provide natural perspective transformations for all viewpoints.

#### 4.2.4 MOVEMENT

Both the observer and object must be capable of movement within space.

#### 4.2.5 SCENE ANALYSIS

A graphic scene must be available for analysis to



permit development by the user before a final drawing is created.

#### 4.2.6 LANGUAGE SYNTAX

The hardest aspect of learning any computer language, is understanding the syntax, therefore the non-numerate user must not be faced with problems such as precedence relationships, evaluation procedures and algorithm design.

#### 4.2.7 LANGUAGE SEMANTICS

The language semantics must be clear and precise, with meaningful graphic names associated with programming elements with the minimum amount of symbolic notation.

#### 4.2.8 IMPLEMENTATION

Assuming that the previous graphic requirements can be met, the remaining features relate to the method of implementation.

If the language is to enjoy a wide range of users, it must be implemented in a language that is readily available, and also be independent of hardware configurations.

The life of the language will depend upon its effectiveness in solving problems, and as the boundaries of art and design are virtually undefined, its life will ultimately depend on how far it can be extended.

#### 4.3 EXISTING SOFTWARE

(10)

In May 1963, L.G. Roberts published a paper illustrating a solution to the hidden-line problem. During the following twelve years many researchers developed other elegant solutions to the same problem, notably, Warnock,<sup>(11)</sup> Loutrel,<sup>(12)</sup> and Matsushita.<sup>(13)</sup>

It is strange that what appears on the surface to be a trivial problem, has attracted so much devoted attention. Even today this one aspect of computer graphics still attracts the inquisitive mind, to discover new methods of resolving the problem.

This complete problem area is concerned with similar conceptual problems, and the deep underlying complexity has created virtual world-wide activity in computer graphics, from the formulation of graphic languages, to the production of computer aided motion pictures.

Solutions to these problems tend to be of a mathematical or logical nature, and demand a skill in computer programming to implement them. Obviously the non-numerate person would be unable to cope in this situation, and is why the majority of artists are unable to develop their own software.

Knowlton describes programmers and artists as "creative, imaginative, intelligent, energetic, industrious,

competitive, and driven", but programmers were "logical, inhibited, methodical...", whilst artists were "alogical (14) impulsive, and intuitive". This gross difference in behaviour, in the author's opinion, is why the artist is unable to cope with the algorithmic nature of scientific programming languages.

Knowlton's collaboration with Mrs. Schwartz (15) although resulted in several creative productions, had similar problems. The programmer (Knowlton) was unable to influence the artistic content of the project, and the artist (Schwartz) was unable to contribute to the programming side of the work. This division of effort is completely unrealistic from both sides, for ideally there should be no need for a programmer. The artist must be in a position to control and guide the entire project from concept, through implementation to the final goal.

In comparison to technical graphic software systems, there are very few systems supporting the art and design area. However the relevant systems are discussed below.

#### 4.3.1 TARPS (KNOWLTON 1971)

TARPS (Two-dimensional Alphanumeric Raster Picture System) was written by Knowlton at the University of California. He describes this language as a set of macros written in terms of BELFIX which describe

operations on a large 92x126 array of alphanumeric characters. The films he produced with Vanderbeek were rather limited in their scope, as they were only concerned with the manipulation of patterns of characters. Knowlton's own criticism was <sup>(14)</sup> "I was disappointed in the language- it seemed too restrictive".

#### 4.3.2 EXPLOR (KNOWLTON 1970)

EXPLOR (EXplicit Patterns, Local Operation and Randomness). This was also written at the University of California and was developed in a collaboration with Lillian Schwartz, resulting in the films "UFO's and Pixillation".

Again, Knowlton was not completely satisfied with the language because of the lack of feedback into the language design process by the users.

It should be realised that TARPS and EXPLOR were not attempts to completely interface the artist to the computer, one can regard them as exploratory systems in the area of animation.

EXPLOR is currently being implemented at Imperial College London.

#### 4.3.3 PDL (G.WYVILL 1972)

PDL (Pictorial Description Language) was written by WYVILL at the University of Bradford, to produce computer drawings with a small budget. This might only

consist of a mini-computer, teletype and a digital plotter.

It is aimed at the artist/designer and includes important language features such as programmer defined words for shapes, simple syntax and an efficient data base system. The main restriction with PDL is its limitation to work in two dimensions. A completely new design philosophy is required to include the handling of 3-D structures.

#### 4.3.4 SPROGS (R.E.THOMAS 1974)

SPROGS (SD 4020 PDP15 Rapid Output Graphics System) was developed by Thomas at the Atlas Computer Laboratory. It is a language consisting of a set of FORTRAN subroutines that interface the user to the SD 4020 microfilm recorder, and VT04 refreshed display.

It is an extremely powerful language to handle an equally powerful computer system. In some respects this is a disadvantage as its user is restricted to the sophisticated computer hardware necessary to drive the recorder.

The language does not appear to contain a large library of shapes, and those that do exist are two-dimensional. The creation of 3-D objects is left to the user. SPROGS also requires a reasonable ability in FORTRAN programming, and thus restricts its use in the area of art and design.

#### 4.3.5 CAMP & CAMPER (FRANCIS, HOPGOOD & RALPHS 1973)

CAMP (Computer Aided Motion Pictures) was developed at the Atlas Computer Laboratory, from an original idea by S.Anderson to produce an efficient picture language for producing computer animated films.

CAMPER is basically a 3-D extension of the 2-D CAMP package.

The authors of the system claim that no knowledge of computer programming languages is required to use it. The user writes a program by creating a sequence of CAMP statements that have a standard format. In this way the beginner need not be concerned with memorizing different statement structures.

The prime objective of CAMP is to interface the user to a microfilm recorder without the user being aware of the underlying complexity that actually exists. So often when a problematical hardware feature is disguised by software, the problem is not always removed, but transformed. CAMP seems to overcome this aspect.

#### 4.3.6 GINO (WOODFORD et al 1965)

GINO (Graphical INput and Output) was developed by the University of Cambridge Computer Aided Design Group, and was designed and implemented as a general purpose graphics package.

The GINO system is accessed via a high-level language

normally FORTRAN, which enables the user to develop, manipulate and eventually display a graphic scene. Probably the greatest advantage of this system is its ability to be interfaced with any system of hardware.

It includes all the features one expects from a sophisticated commercial package and consequently demands a high-level programming expertise from the user. GINO has not been designed to cater for the user working in art and design, but could play an important role in implementing such a system.

#### 4.3.7 ART1 (NASH & WILLIAMS 1970)

ART1 was developed at the University of New Mexico to permit students to produce graphic output using a line-printer or teletype. Obviously the limitations are considerable, but it presents a simple and practical method of introducing computing concepts to art students.

At present Teeside Polytechnic are using the package in their DipAD and are hoping to develop an interactive version.

#### 4.3.8 PLAD (SAUNDERS, R 1972)

PLAD (Programming Language for Art and Design) was written by Roger Saunders as a B.Sc. project at Brighton Polytechnic. It is based upon the language ART1, but provides a formal problem-oriented language

to express primitive graphic ideas that is not available in ART1. The output is in the form of patterns of characters that may be overprinted to achieve shading, and therefore has limited applications.

Although this is an excellent tool for the artist, it still does not provide a language that can be used with a wide variety of graphic problems.



## 5 PICASO

### 5.1 DESIGN PHILOSOPHY

PICASO has been designed to satisfy a need for software in the area of art and design. The design specification for the language was as follows:

- 1) allow the user to manipulate graphic concepts in a meaningful way,
- 2) maintain language syntax and semantics at a non-technical level,
- 3) ensure an extensible language,
- 4) machine independent,
- 5) permit interfacing with various graphic peripherals,
- 6) permit implementation on small memory computers, and
- 7) be easily implemented by other users.

The design of any program normally requires some sort of compromise in the design specification or mode of implementation to ensure a successful completion to the project. If any compromise occurred in the design of PICASO it was rarely detrimental to the above specification, but did cause great concern when algorithms were developed to produce surfaces with hidden-line removal, and still allow them to be implemented on small machines.

The small-machine environment makes great demands upon a programmer's creativity, especially in discovering algorithmic techniques to implement

ideas that at first sight demand a vast memory.

Whenever there was a choice between object run-time and memory, the former was sacrificed, but to help offset this, the coding stage was greatly influenced by statement execution times with the emphasis on efficiency.

The project demanded extensive research to establish existing software and the retrieval of papers concerned with important concepts such as hidden-line removal, windowing, perspective etc. Although this was an essential exercise, the author was unable to implement these ideas without sacrificing the design specification. As a result of this, considerable time and effort was devoted to research into algorithms to solve the same problems within the small machine environment. The outcome of this work established a highly integrated structure that enabled PICASO to be designed in modules. From the outset, the complete modularity of the system permitted it to be thoroughly tested with the introduction of a new module which has given PICASO a high level of integrity.

A detailed evaluation of how the system was implemented follows.

## 5.2 SYSTEM STRUCTURE

PICASO is derived from the words:

Picture Computer Algorithms Subroutine Orientated, and consists of an integrated system of procedures that are sensitive to a common data structure to handle two and three-dimensional graphic structures.

The system is implemented in FORTRAN IV to ensure that it is machine independent and easily implemented by other users.

Figure 5.2.1 shows a block diagram illustrating the underlying concepts employed in PICASO. The user is permitted to work in two and three-dimensional space in the same program and manipulate shapes and objects with equal ease. The shape and object libraries supply a comprehensive range of structures including polygons, ellipses, cubes, cones, spheres etc., and external structures may be input via any peripheral capable of communicating coordinate data.

Algorithms may then be used to manipulate structures within the conceptual and projection spaces before finally being realised on the projection space which represents the computer graphic media, such as a digital plotter or display screen.

The realisation of 2-D shapes is a simple process of interpreting the shape's spatial frame of reference as the projection frame of reference, but 3-D objects are realised by locating an observer within the object's conceptual space, and viewing through a picture plane which represents the projection space. The mode of

viewing may be true three-point perspective or wide-angle perspective, but could be extended to include any type of mathematical projection.

To permit the user to optimise a scene, algorithms are available to reference the conceptual and projection spaces and supply spatial and graphic information back to the user who is then able to control the growth and development of his work.

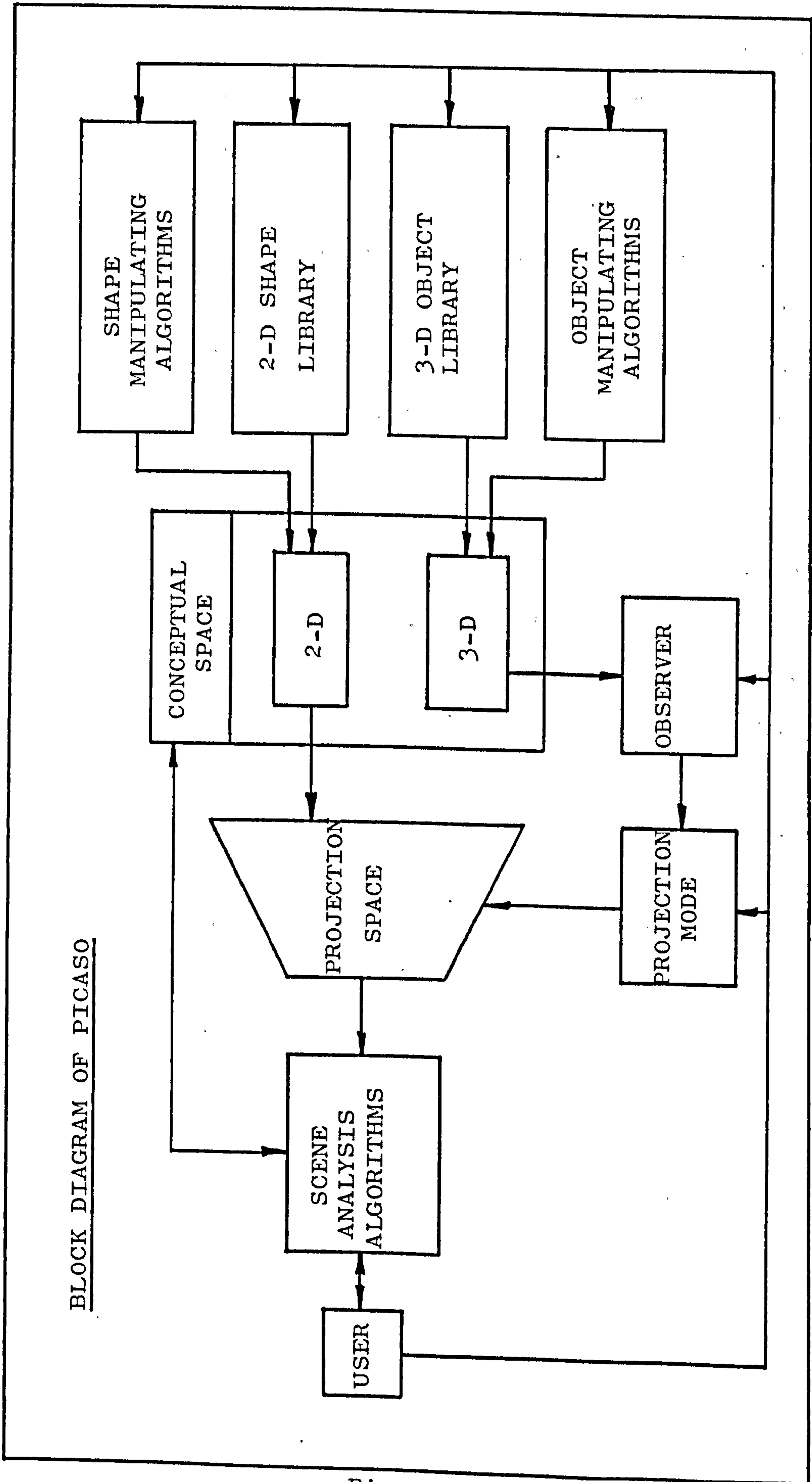

Figure 5.2.1

### 5.3 LANGUAGE SYNTAX AND SEMANTICS

PICASO is an integrated set of FORTRAN subroutines and functions that may be called or referenced by a main program. The modularity is such, that a beginner is required to know extremely little about the syntax of FORTRAN apart from the CALL statement, however, there are three programming concepts that must be understood, namely: numbers (INTEGER and REAL), variables and sequential processing, but these are relatively easy to comprehend.

A typical program will only consist of CALL statements, apart from STOP and END, with the underlying complexity of the system completely transparent to the user, but the language semantics are made self-evident by the choice of procedure names. The following program might be attempted by someone who has only had approximately two to three hours tuition in PICASO, but allows him to immediately appreciate and handle three-dimensional objects and realise perspective views.

```

CALL START
CALL ORIGIN(           )
CALL EYE(              )
CALL CUBE(BOX,         ) arguments are
CALL ROW3D(BOX,        ) omitted for clarity.
CALL FINISH(          )
STOP
END

```

The objective of the program is to initialise plotting, (CALL START) establish a new origin on the paper, (CALL ORIGIN) and locate an observer in the 3-D conceptual space (CALL EYE). A cube is called from the object library (CALL CUBE) and given the name BOX, and a regular row of cubes is drawn in perspective as seen by the observer (CALL ROW3D). Finally, plotting is terminated, the program stopped (CALL FINISH and STOP).

The ability to identify structures by real-world names is an essential requirement of any graphics language, and what the PICASO user is actually doing when he identifies an object by a name, is reference a FORTRAN vector that stores the vertex data of the structure.

Once the user has written several programs consisting entirely of CALL statements, he is in a position to use arithmetic statements and the DO statement which provide programming techniques to solve quite complex problems. Independent of the language chosen, the user would have to master and understand its syntax and semantics, and it is believed that these aspects of PICASO have been maintained at a level that is acceptable to the non-numerate user.

#### 5.4 PICASO SPATIAL CONVENTIONS

As described in section 5.2, PICASO employs a conceptual and projection space that are referenced by conventional methods. The axial systems are shown in Figure 5.4.1.

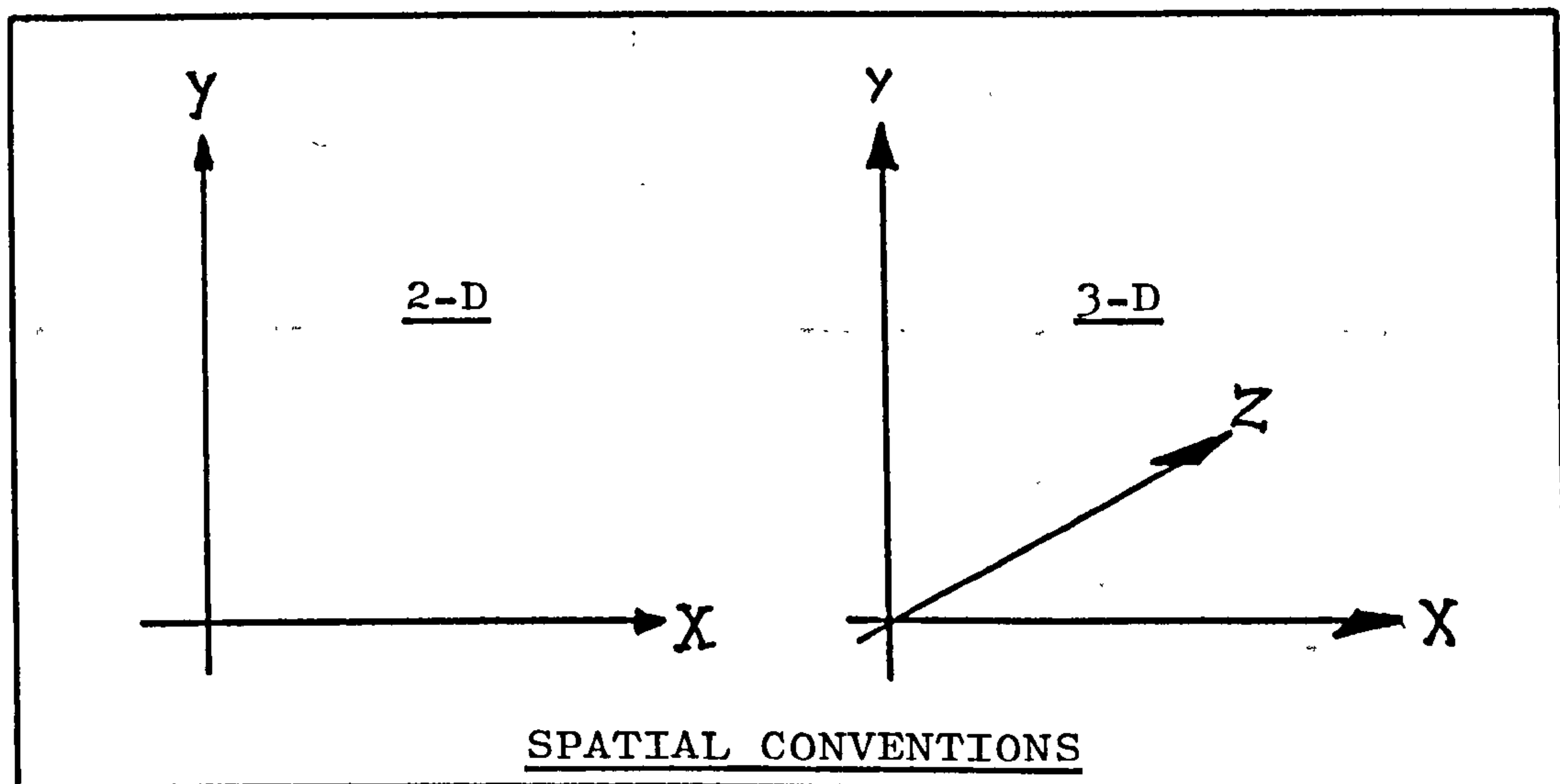

Figure 5.4.1

For the two-dimensional mode the conceptual and projection space origins are coincident, whereas the three-dimensional mode enables the origin of the projection space picture plane, to be located anywhere on the line connecting the observer's eye, and the point under observation in the 3-D conceptual space. Figure 5.4.2 illustrates this transformation process diagrammatically.

A common feature of algorithms creating perspective transformations, is their excessive execution time due to the use of trigonometric functions, consequently, PICASO employs a labelled-common block to hold partially evaluated data concerning direction cosines, the eye



location and the point under observation; this avoids the repetitive evaluation of items that are constant for a given observer's location. The common block also communicates the mode of projection which can either be true or wide-angle perspective, but as these transformations are produced by one module, any future requirement can be catered for by substitution of this module.

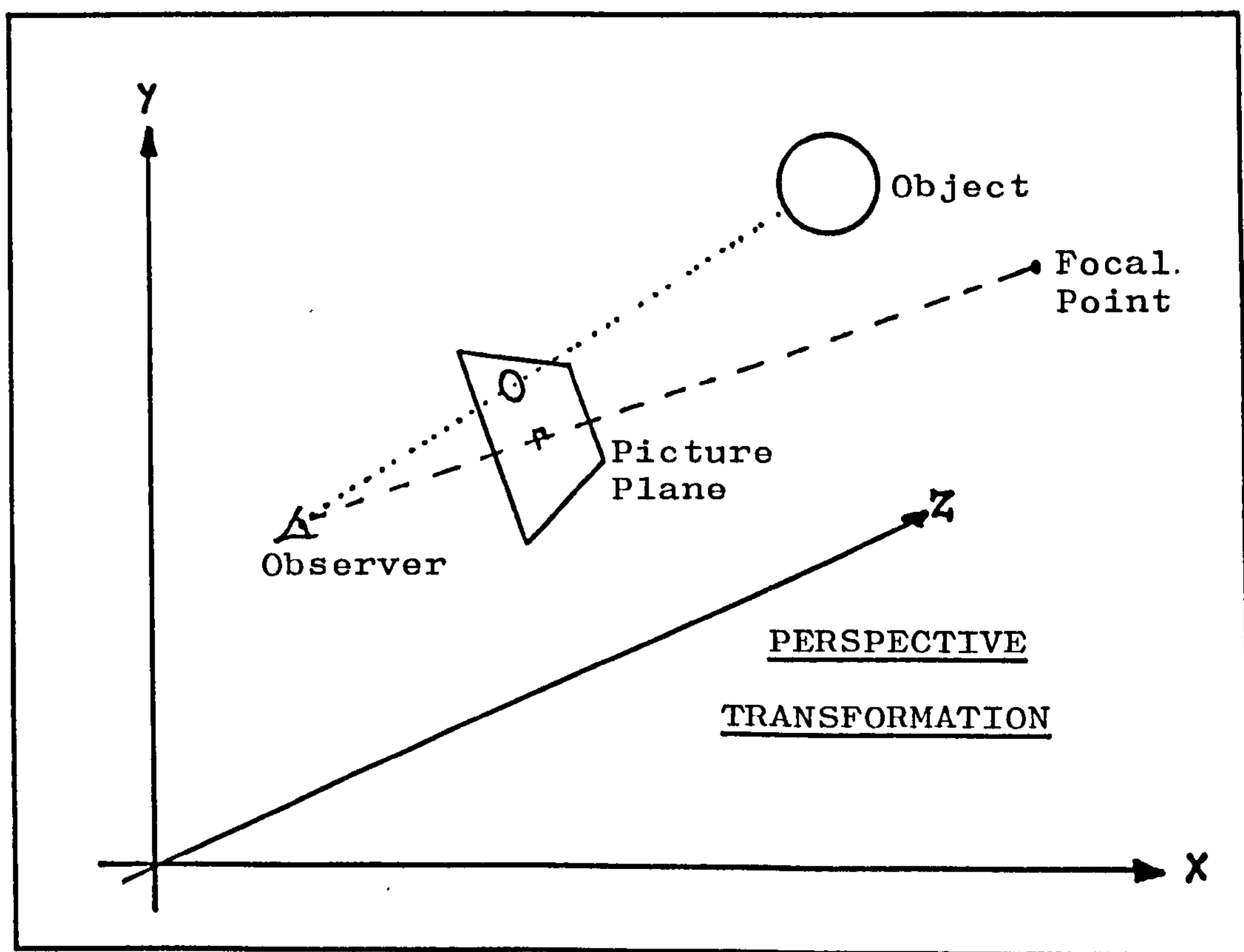

Figure 5.4.2

## 5.5 PICASO STRUCTURES

A PICASO structure may either be a two-dimensional shape or a three-dimensional object, and is stored in a FORTRAN vector as shown in Appendix XII.

A structure may consist of one or more continuous sequences of vertices, that are eventually connected by straight lines when realised on the projection space. These contours may be open or closed depending on whether the first vertex is referenced again as a terminal vertex. A 2-D contour is nothing more than a line existing on a surface, namely the picture plane, however, a 3-D contour may be interpreted as a surface existing in conceptual space and be used to assemble transparent or opaque objects.

The vertex sequence has great significance, as it is used to provide hidden-line removal, masking, windowing and shading, but this is explained later in section 5.7.

PICASO permits the user to access structures in two modes, either from the internal library, or from an external source via an input peripheral. The contents of the 2 and 3-D libraries is shown in appendices III and VI.

The author believes that a structure library is an extremely important aspect of any graphics language, as it can determine whether the user will succeed in mastering the system, or surrender through frustration

in being unable to reproduce any form of graphic output.

At present, the subroutine SHAPE and OBJECT are used to access structures from punched cards, future routines are planned to access vertex data from other sources of coordinate data.

The majority of shapes are generated by functions, but the system includes others such as HORSE, FACE and BUTFLY (butterfly) etc., that are actually stored in coordinate form; this is included because the beginner is then able to handle familiar shapes and thus acquire an immediate confidence in the language.

Obviously this aspect of PICASO is completely extensible and will depend entirely upon the needs of the user.

The family of function derived shapes consists of standard mathematical forms and provides the user with anything from a line to a hypotrochoid.

All structures are assigned a programmer defined REAL FORTRAN name, and are manipulated and drawn by reference to this name.

## 5.6 STRUCTURE MANIPULATION

An essential feature of computer graphics is structure manipulation, and PICASO includes a powerful system of commands enabling the user to control and manipulate precisely any PICASO structure. These commands are listed in appendix V.

The basic operations to control size, displacement and rotation are obvious requirements, but the artist is always interested in transformations that probably have no direct application in standard graphic systems, but are useful from an artistic point of view.

Consequently, the author designed many unusual algorithms to complement the standard list of procedures; some of these are now explained.

### 5.6.1 CYCLE

Any PICASO contour consists of vertices connected by straight lines. What CYCLE does, is to move the position of a vertex to a new position on the line connecting it to its neighbour. If this process is repeated continuously, some effective designs result. Three examples are shown in Figure 5.6.1.

### 5.6.2 ASMDSH

PICASO's graphic power derives from the ability to handle complex geometric structures by name, and manipulate them as an entity. At an early stage in this project, the author considered the graphic

analogue of the FORTRAN arithmetic statement. For example, the following statement:

$$I=J+KxL$$

could be written in graphic concepts as:

$$\text{Ⓛ} = \square + \triangle * \bigcirc$$

where a triangle is multiplied by a circle and added to a square, producing some resultant shape. ASMDSH (Add, Subtract, Multiply and Divide SHapes) is the result of considerable research into this problem, and performs four arithmetic operations upon any PICASO structure by manipulating the numeric values of the vertex coordinates. When structures contain unequal numbers of vertices, linear interpolation establishes intermediate positions. ASMDSH provides a powerful method of generating families of shapes that would be extremely difficult to define mathematically, due to the nature of their derivation.

Figure 5.6.2 shows the effects of adding, subtracting, multiplying and dividing a circle and a triangle.

### 5.6.3 FORM3D

Provides a quick method of creating distorted 3-D surfaces from 2-D shapes. The user supplies a PICASO shape, together with a open 2-D contour which 'forms' the z-coordinate thus forming the third dimension.

Figure 5.6.3 shows the result of an elephant formed by a bend.

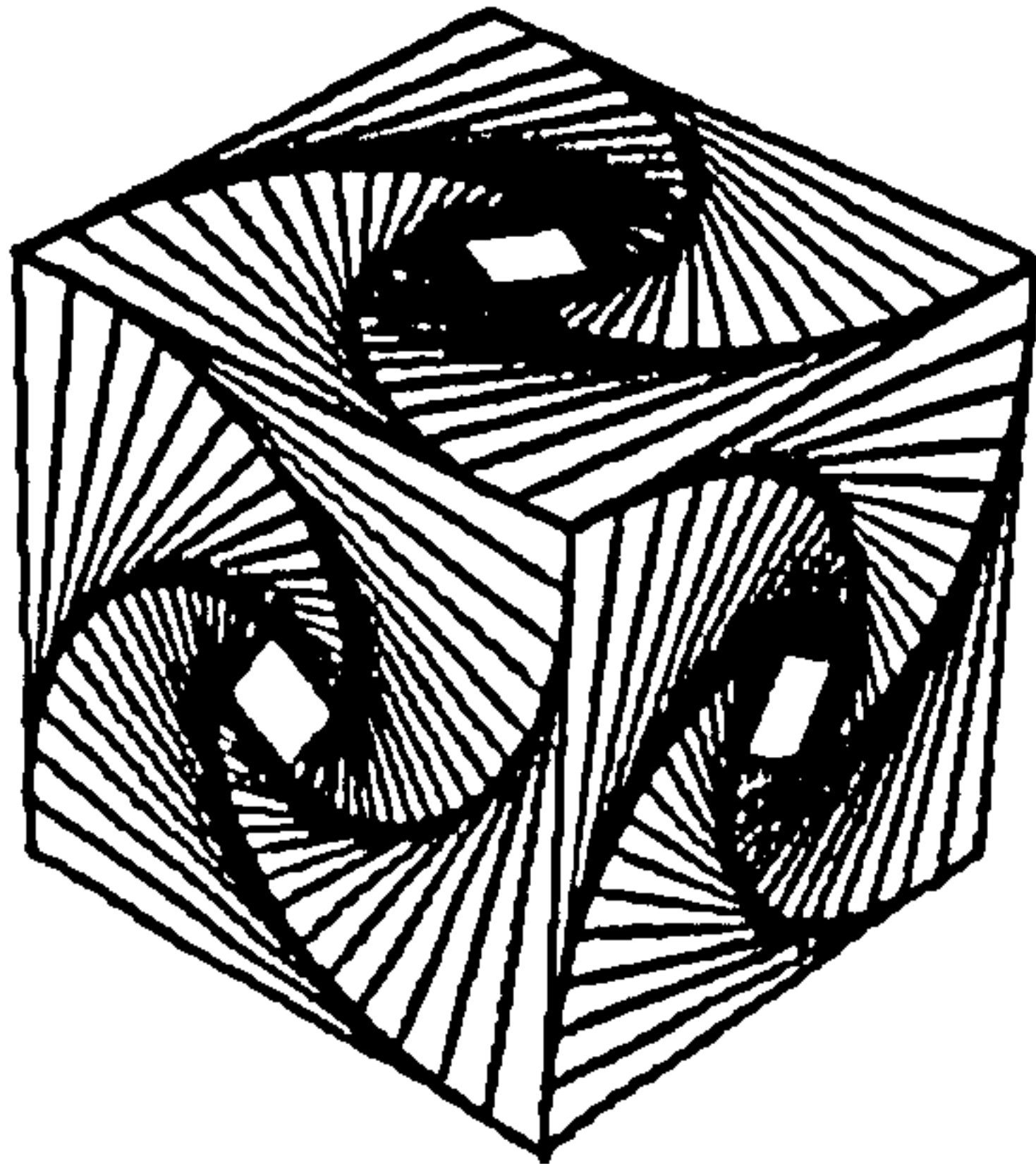
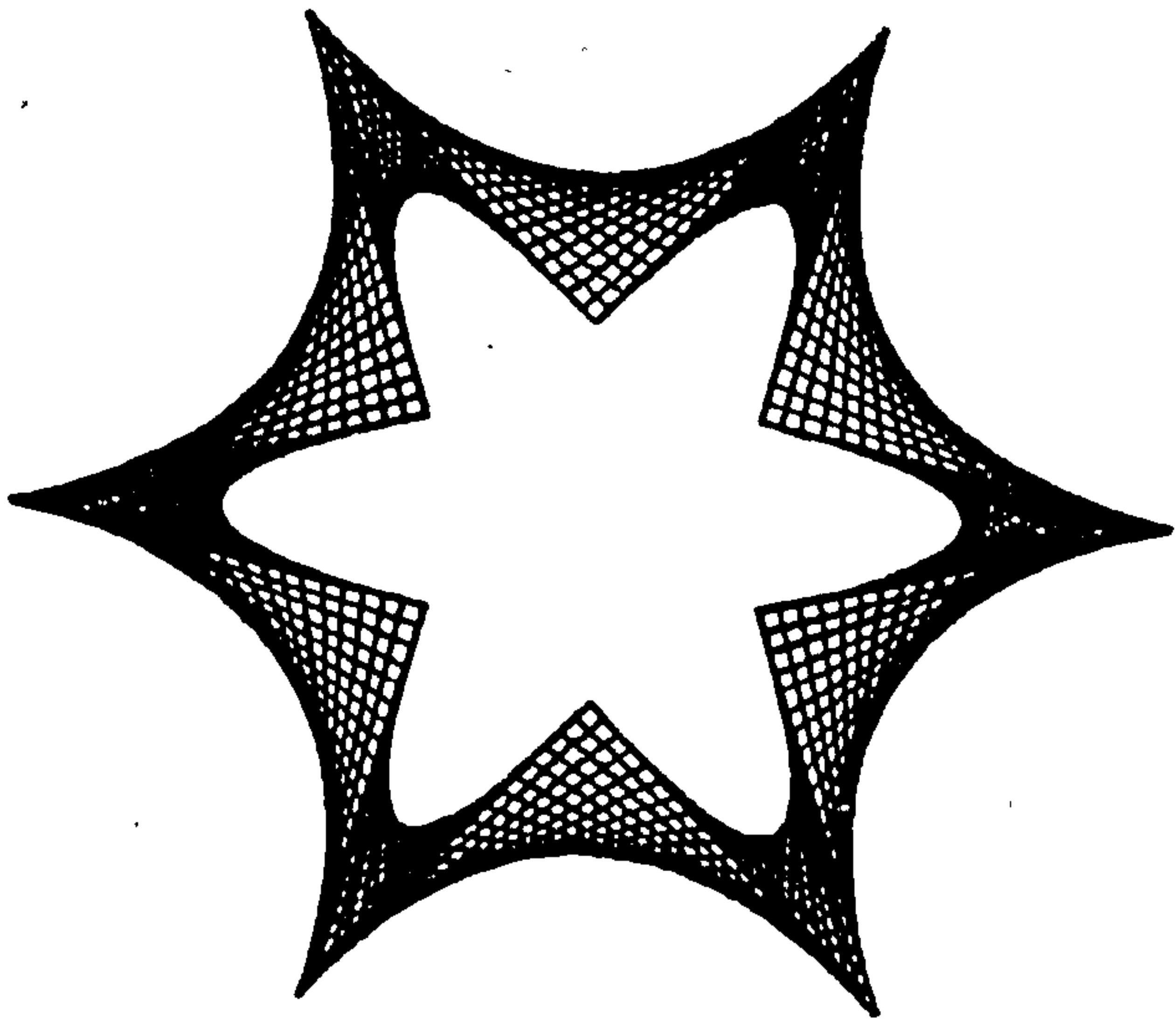
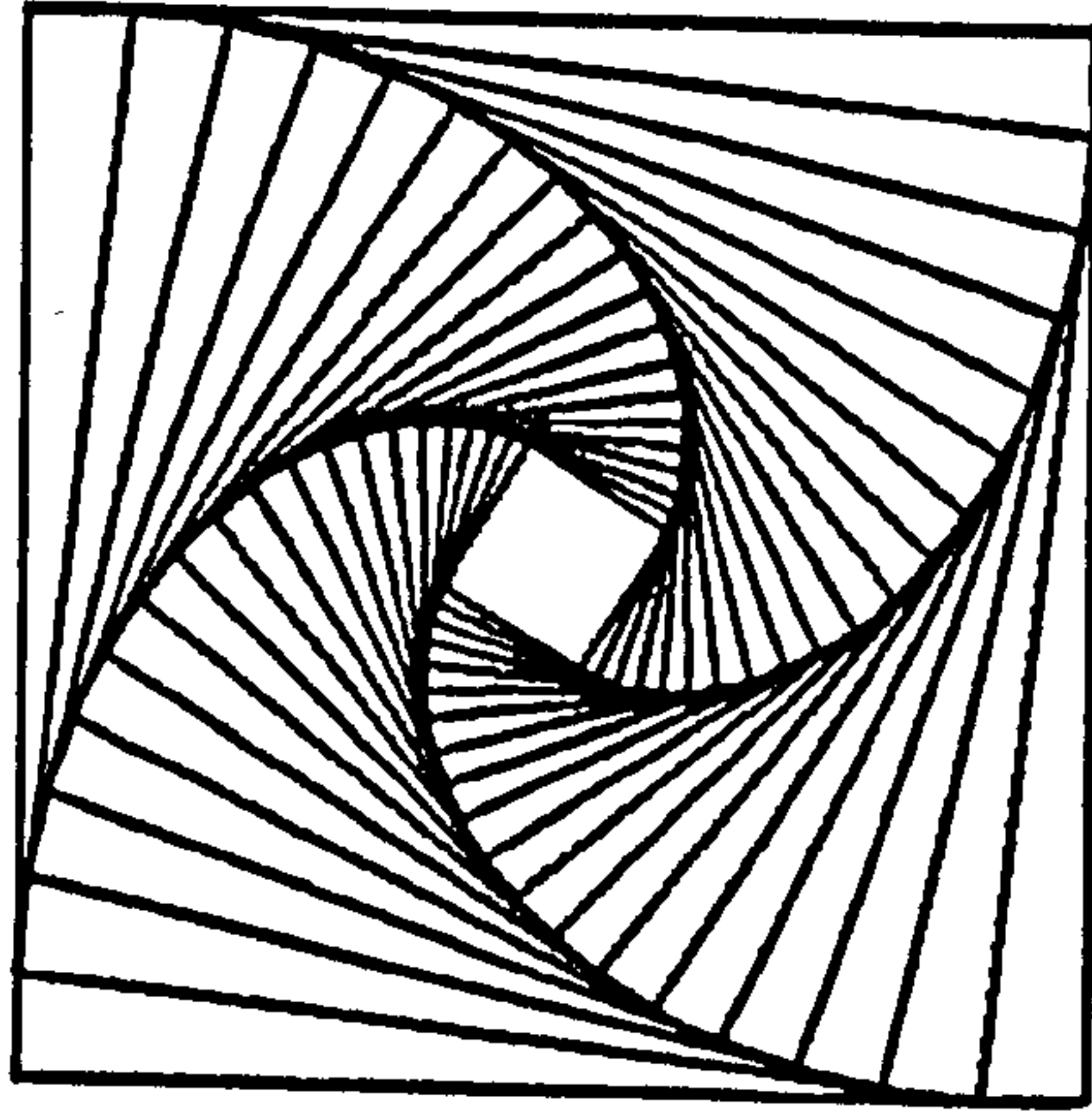

CYCLE

Figure 5.6.1

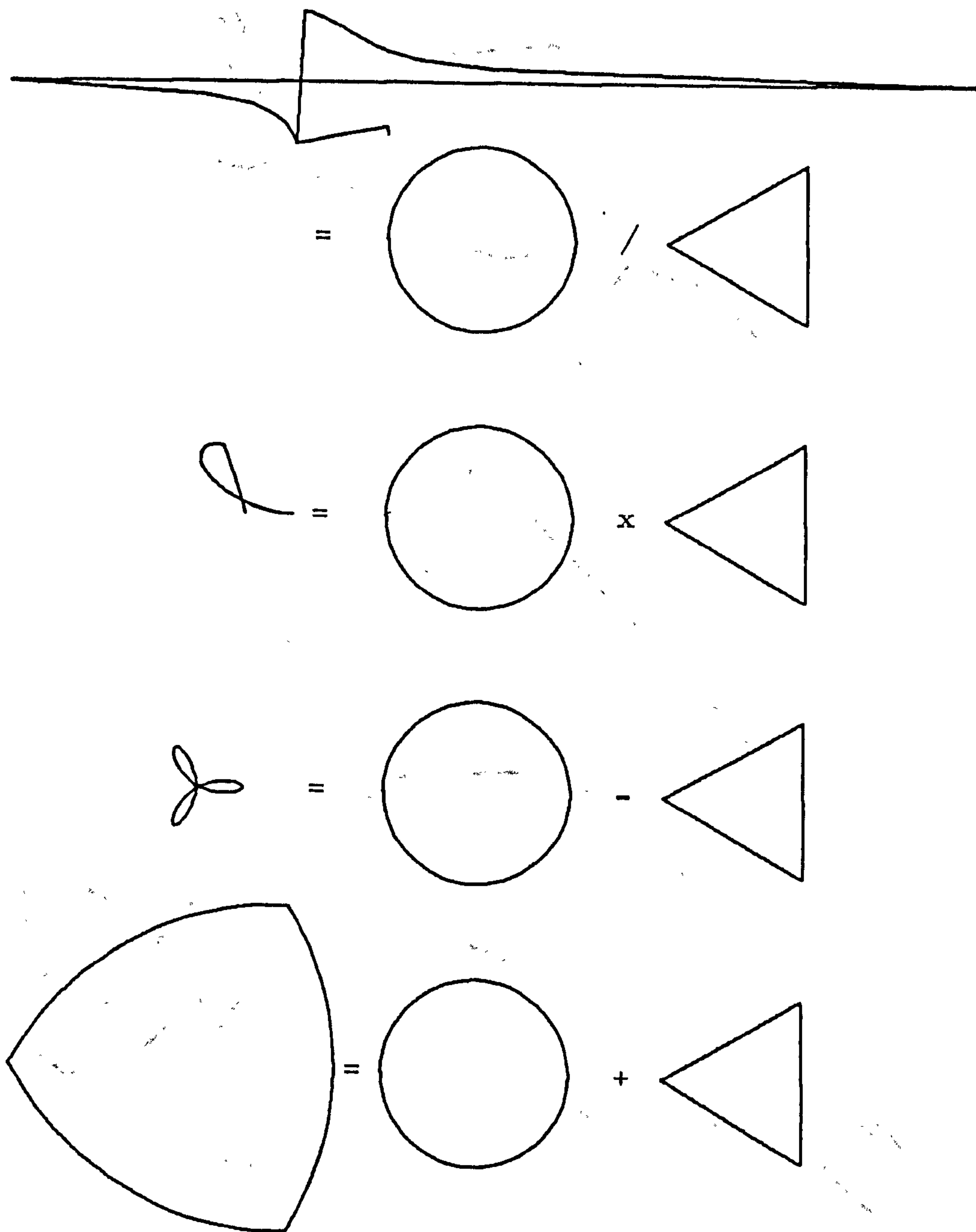

ASMDSH

Figure 5.6.2

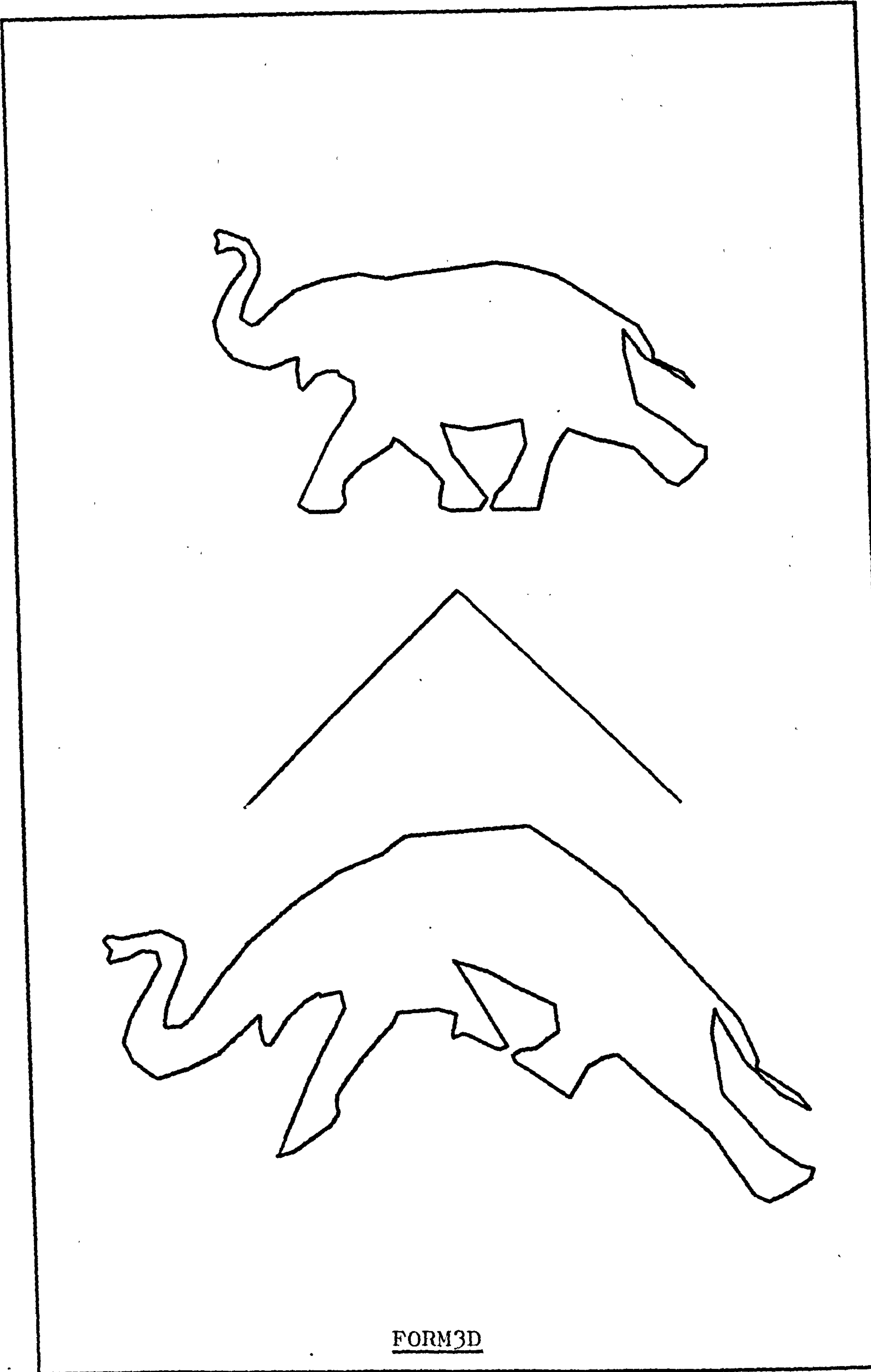

FORM3D

Figure 5.6.3



#### 5.6.4 TRACE

TRACE generates a new shape that results from tracing a point a specified distance in or outside some PICASO shape. The result depends entirely upon the convex and concave features of the original shape, and often surprises the user. Figure 5.6.4 illustrates the effect of tracing around a horse and tracing inside a butterfly.

#### 5.6.5 TRANSH

Shape transformation has often been exploited in computer art, and PICASO is supplied with the subroutine TRANSH to transform any 2-D contour into another, or any 3-D surface into another. When a sequence of transformations are superimposed upon one another, a distinctive and effective picture results. Figure 5.6.5 shows a square-law transformation of a face into a square.

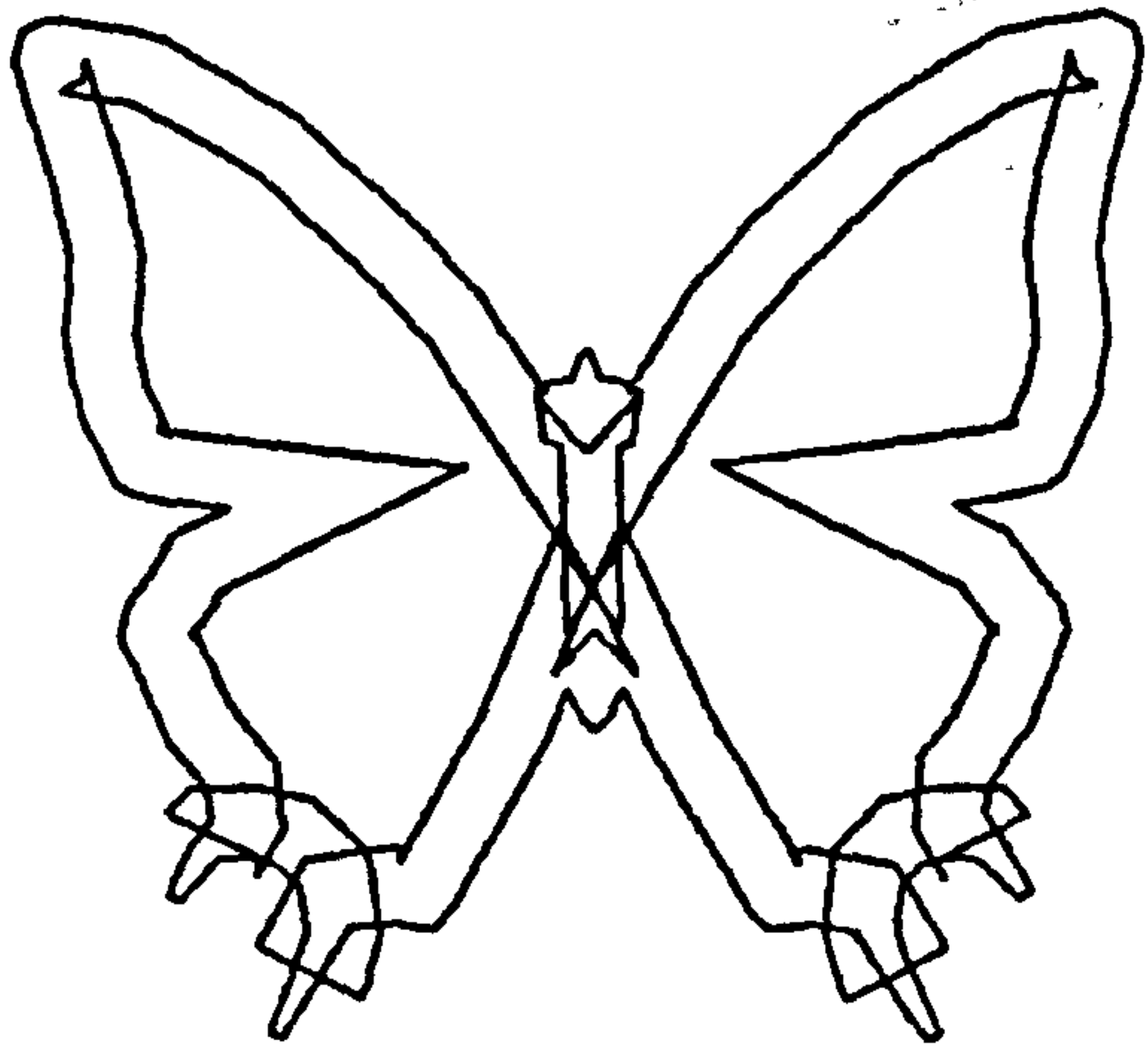
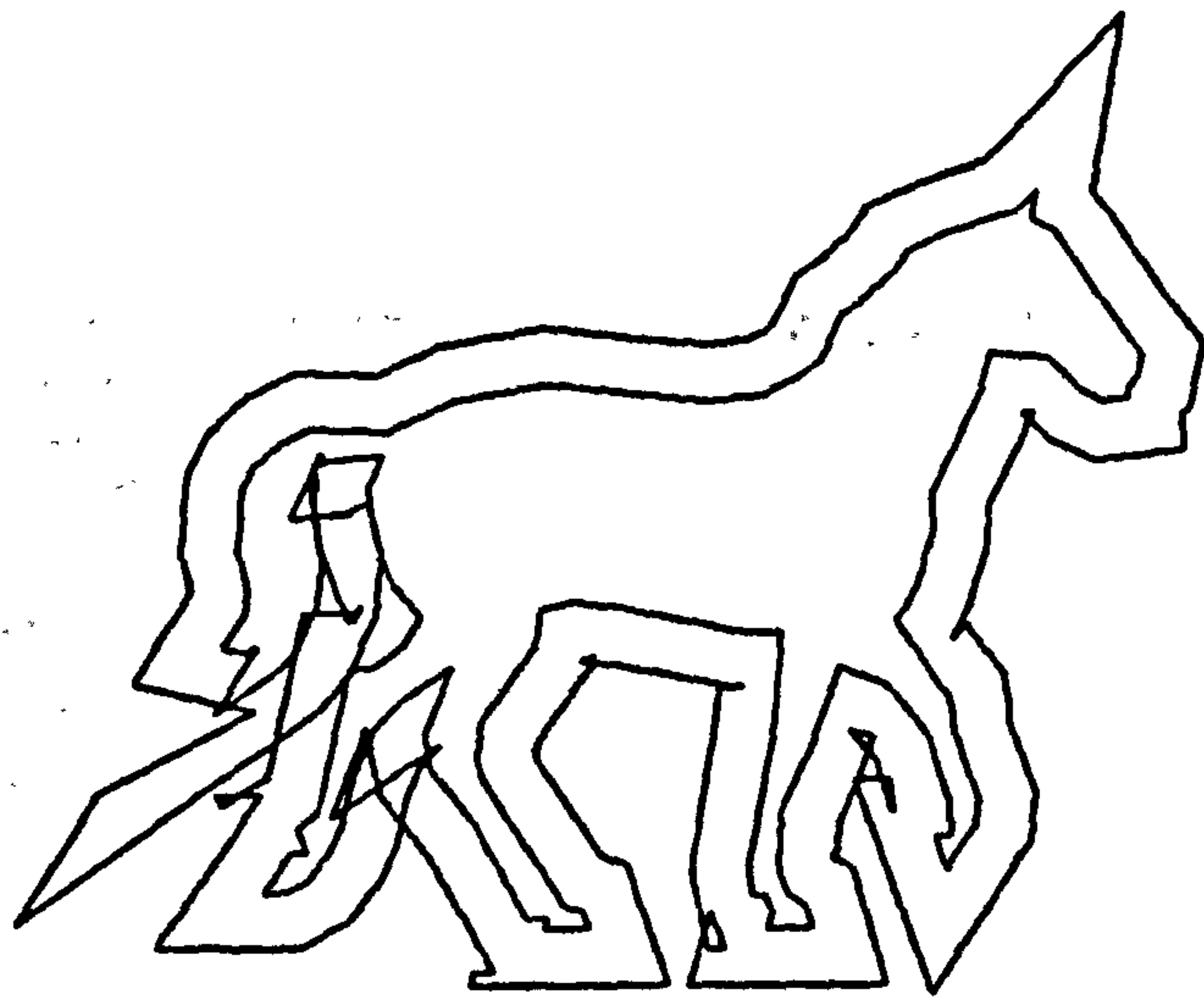

TRACE

Figure 5.6.4

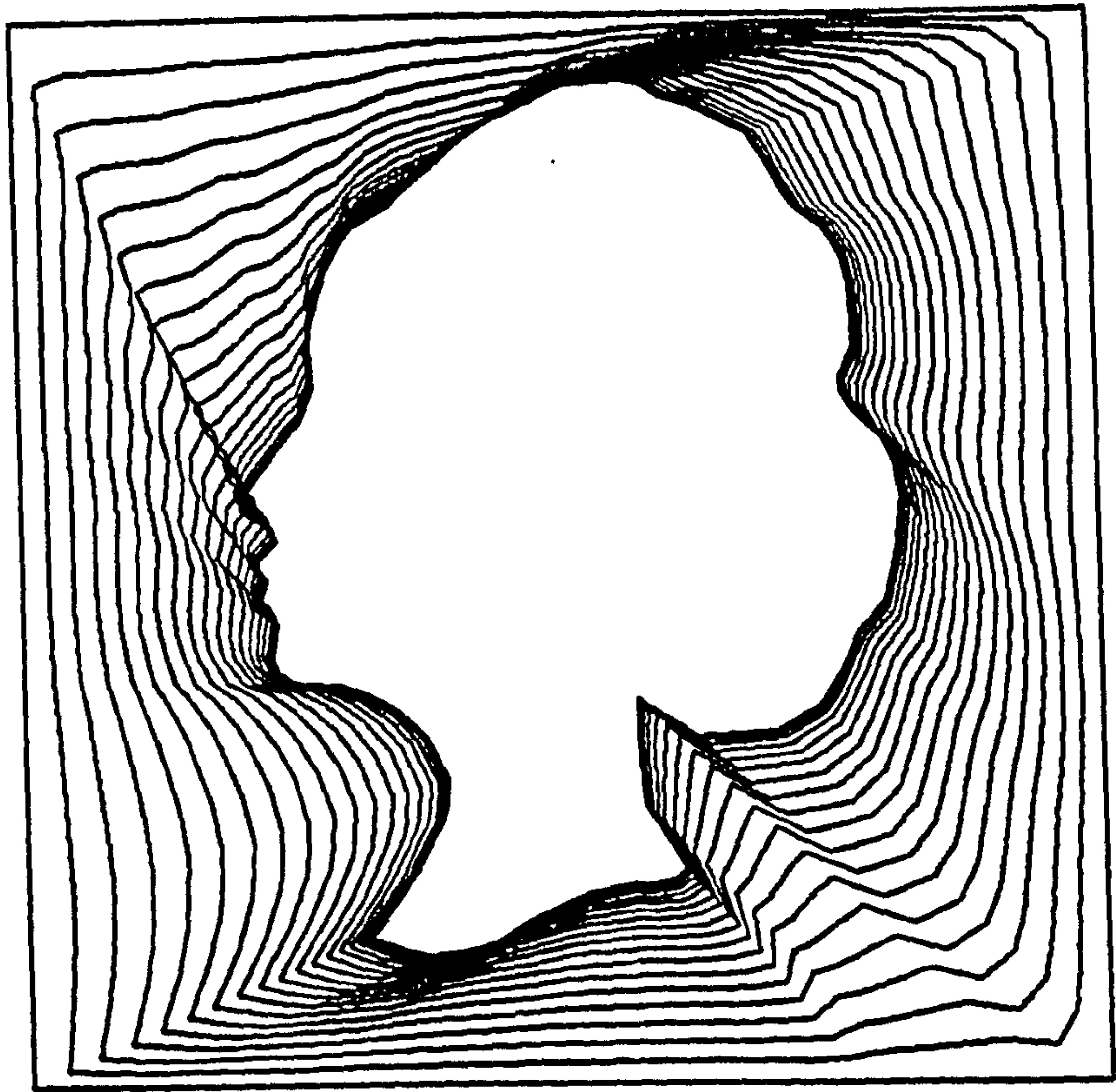

TRANSH

Figure 5.6.5

### 5.6.6 WARP2D & WARP3D

These two subroutines enable the user to establish different laws to control the conceptual space, thus creating 'space-warp' effects. For example, it might be required to apply a logarithmic law to the z-direction, a hyperbolic law to the y-direction, and a square law to the x-direction, and then view a system of objects through a wide-angle lens. The less esoteric operation of folding about the x-axis could be achieved by making the x-coordinate function equal to :  $F(x) = \text{ABS}(x)$ ; this effect is shown in Figure 5.6.6 with a rhinosceros.

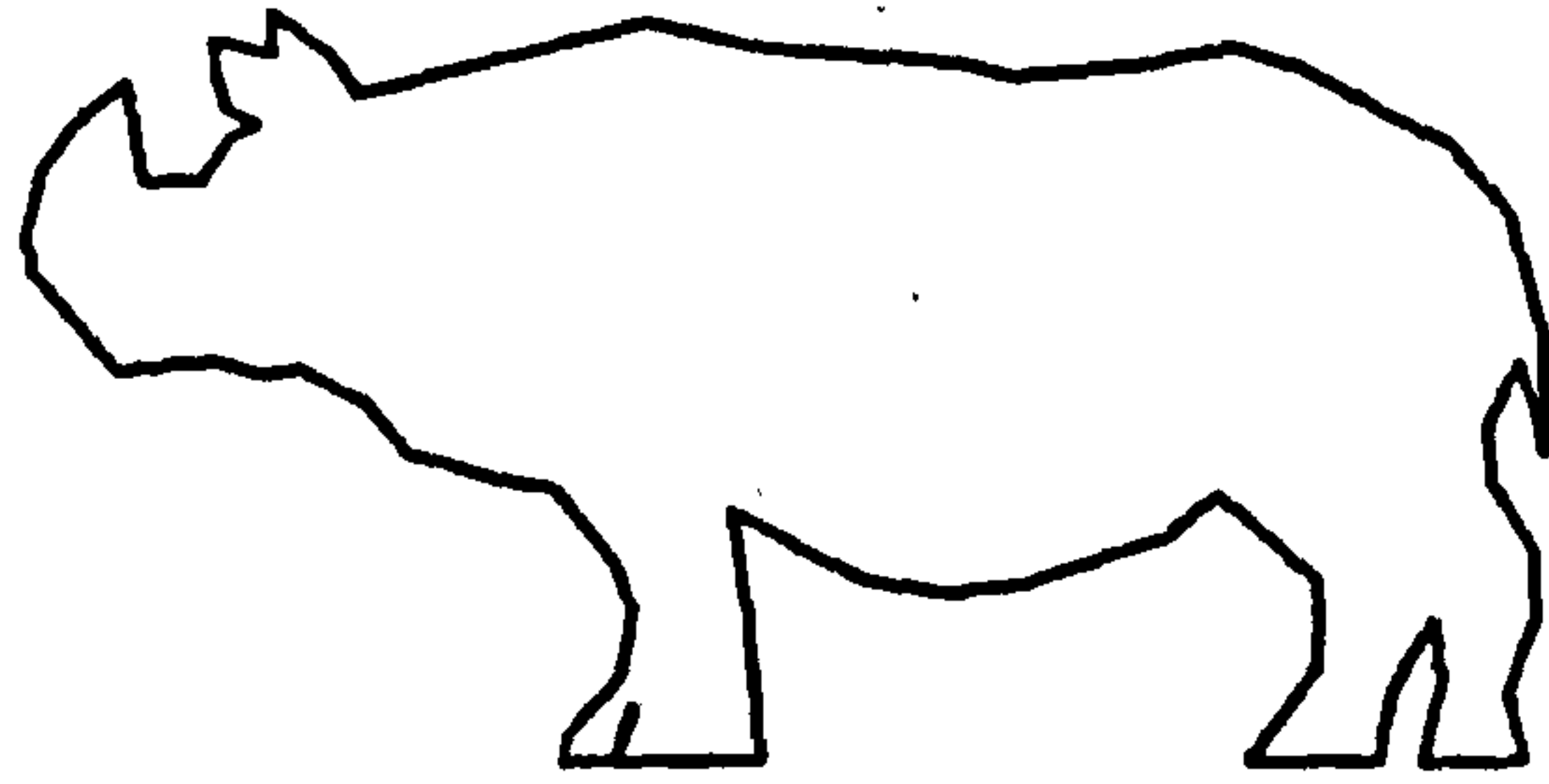

WARP2D

Figure 5.6.6

## 5.7 PICASO DRAWING COMMANDS

The PICASO drawing commands transform data from the conceptual space to the projection space. At the individual structure level this includes DRAW and DRAW3D which manipulate a single shape or object respectively; but at the group structure level, shapes and objects may be referenced by rows and two types of regular grids.

One practical problem with the projection space is being capable of containing the contents of the transformed conceptual space. To safeguard the user from drawing beyond the boundaries available, a powerful windowing facility is included which accepts any multiple contour PICASO shape to window the projection space. If the window shape contains contours with their vertices specified in a clockwise sense, then these behave as transparent windows, but counter-clockwise contours mask the drawing. The example shown in Figure 5.7.1 is of a scene with and without a window. The technique employed in this process is explained in Appendix XIII.

When an observer is located in 3-D conceptual space, care must be taken to ensure a location is chosen that is physically meaningful, as this can result in a confused distorted projection. For example, if the observer's eye was inside an object, vertices behind the eye would not be seen and must be clipped

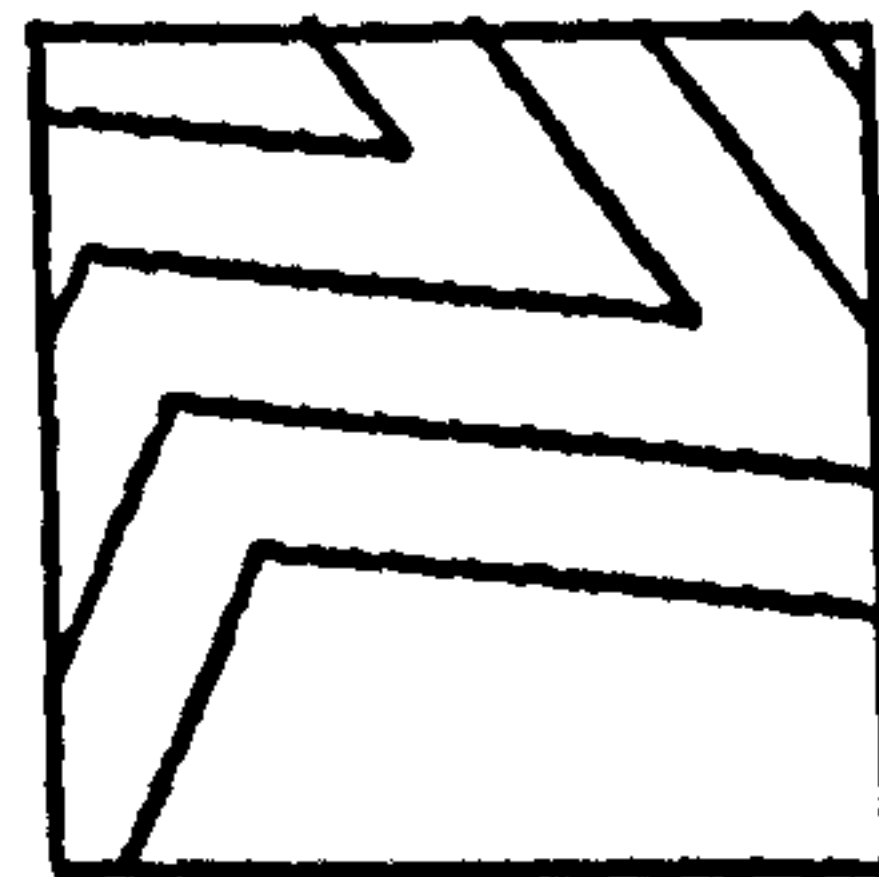
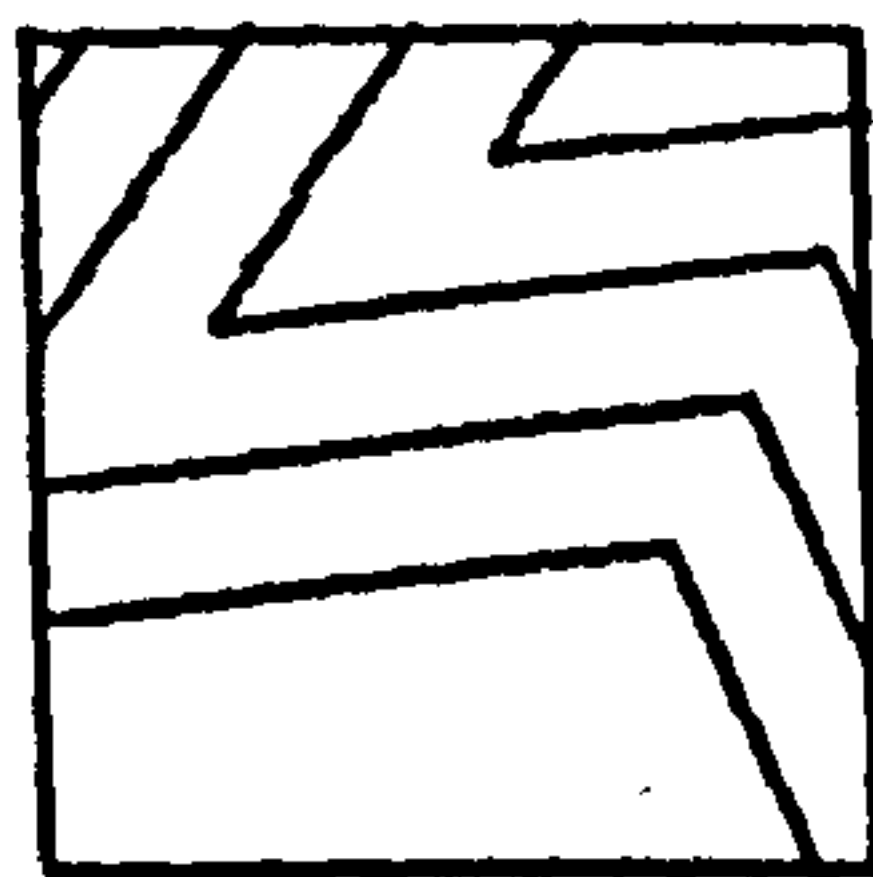
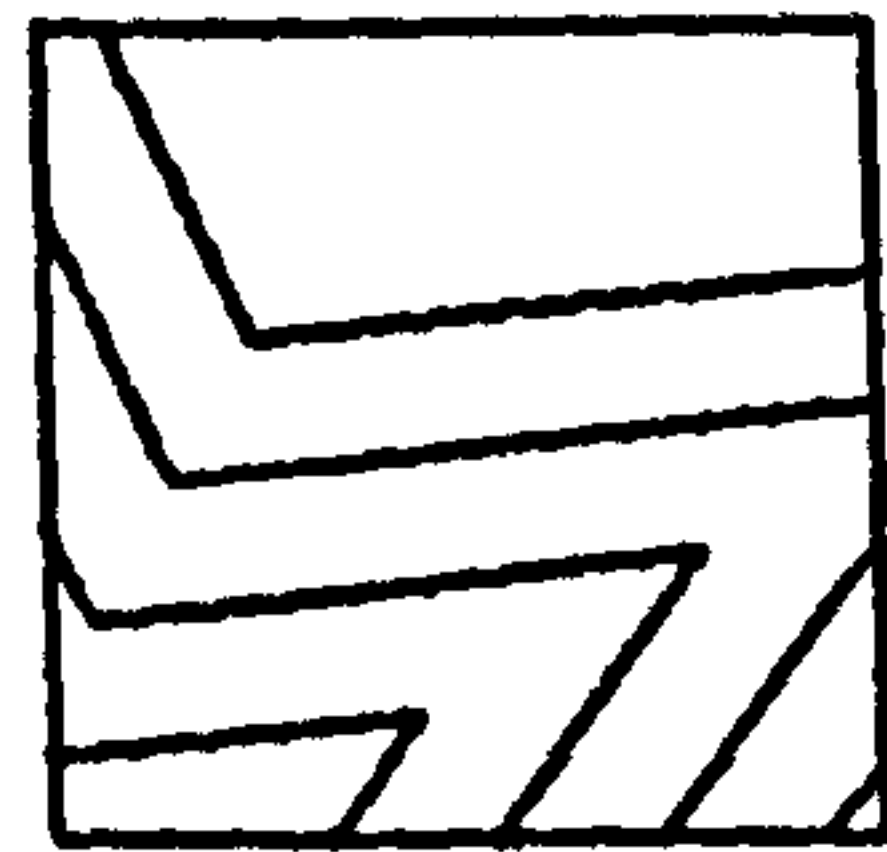
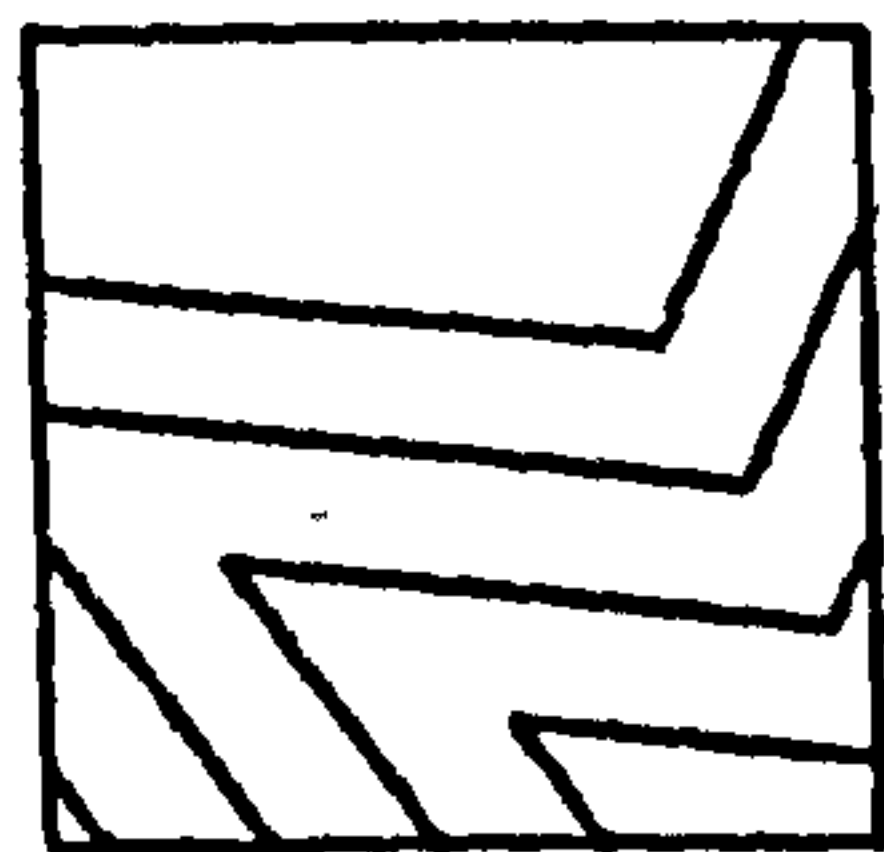
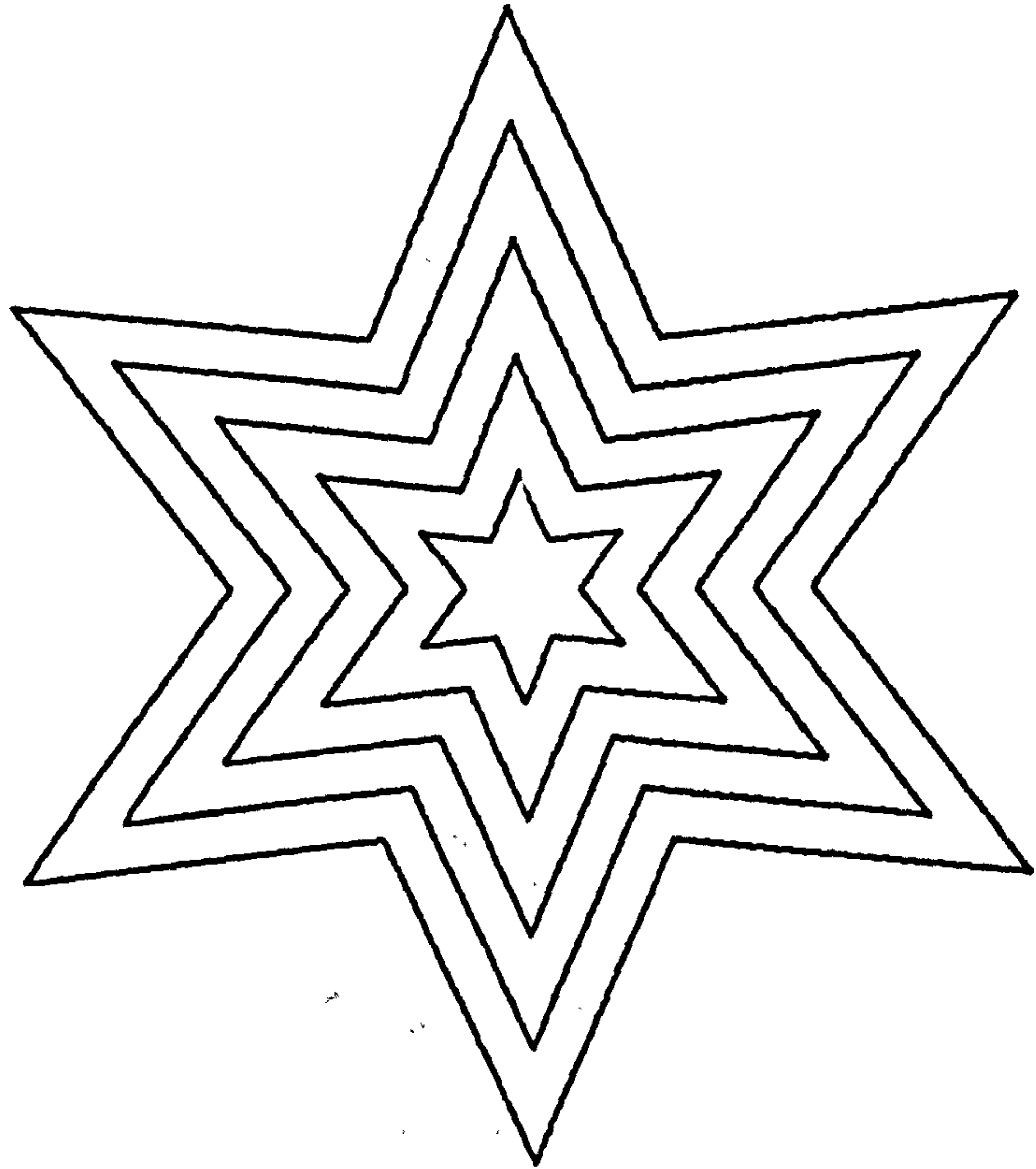

WINDOW

Figure 5.7.1

4

UNSEEN

3

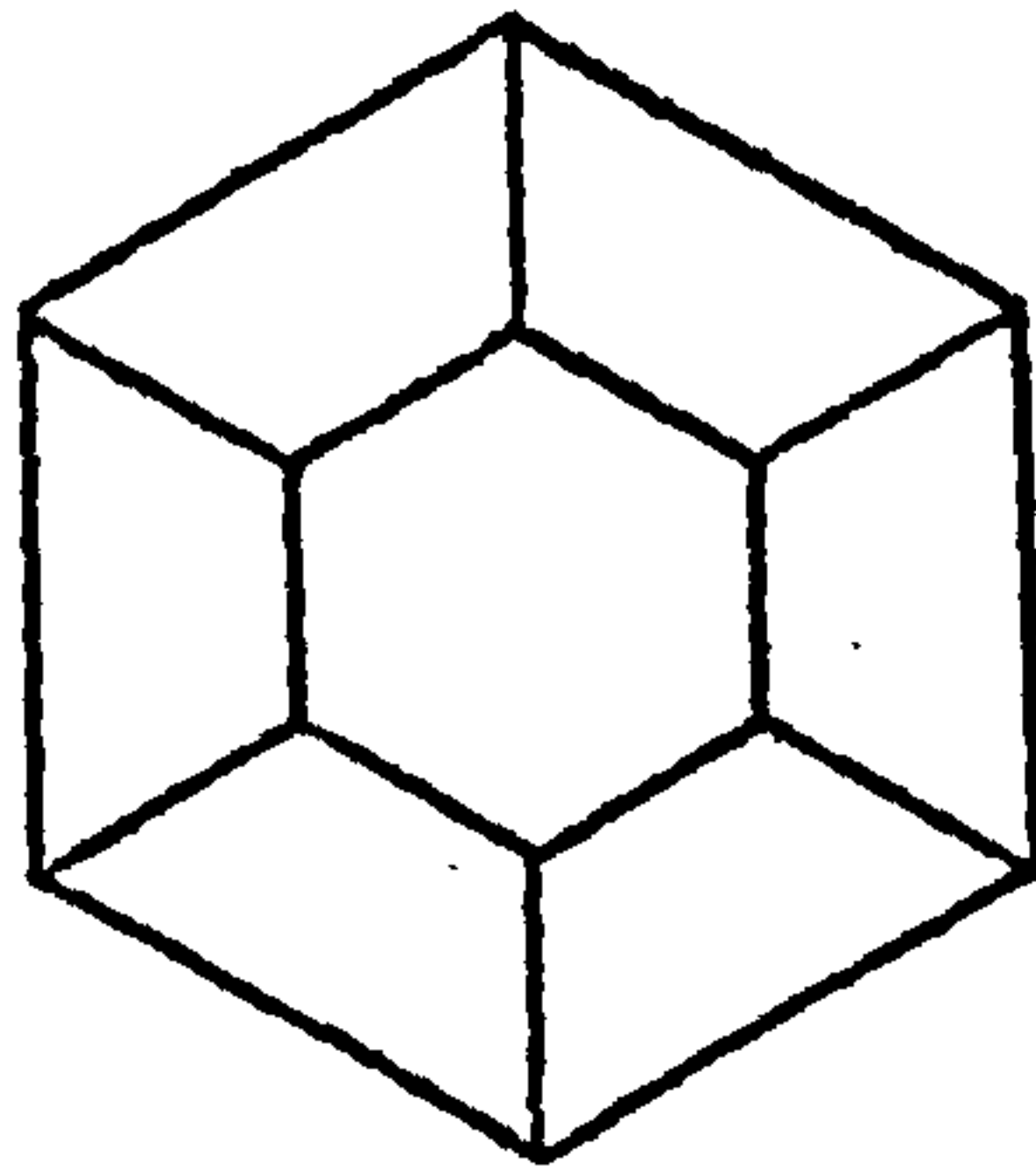

2

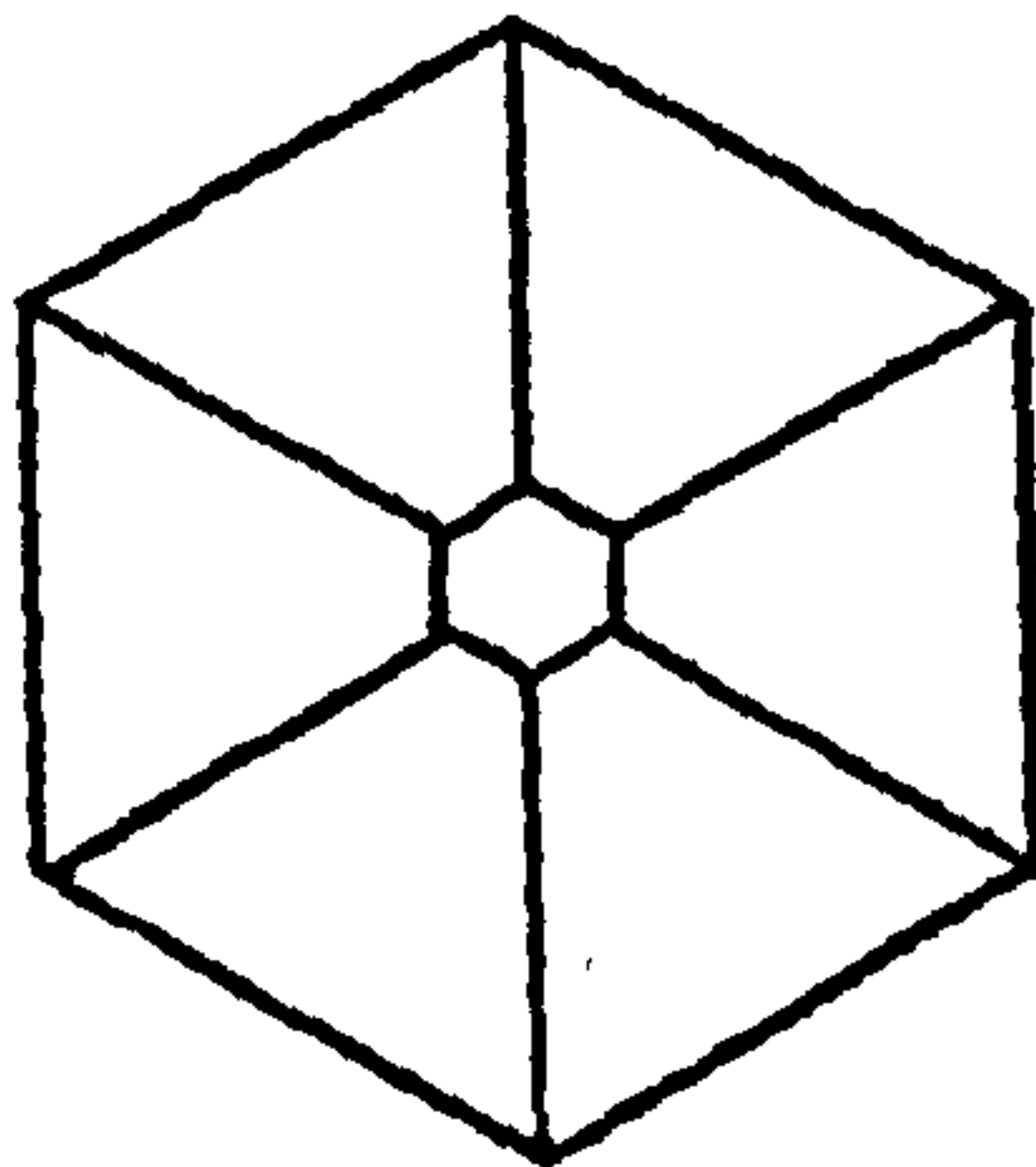

1

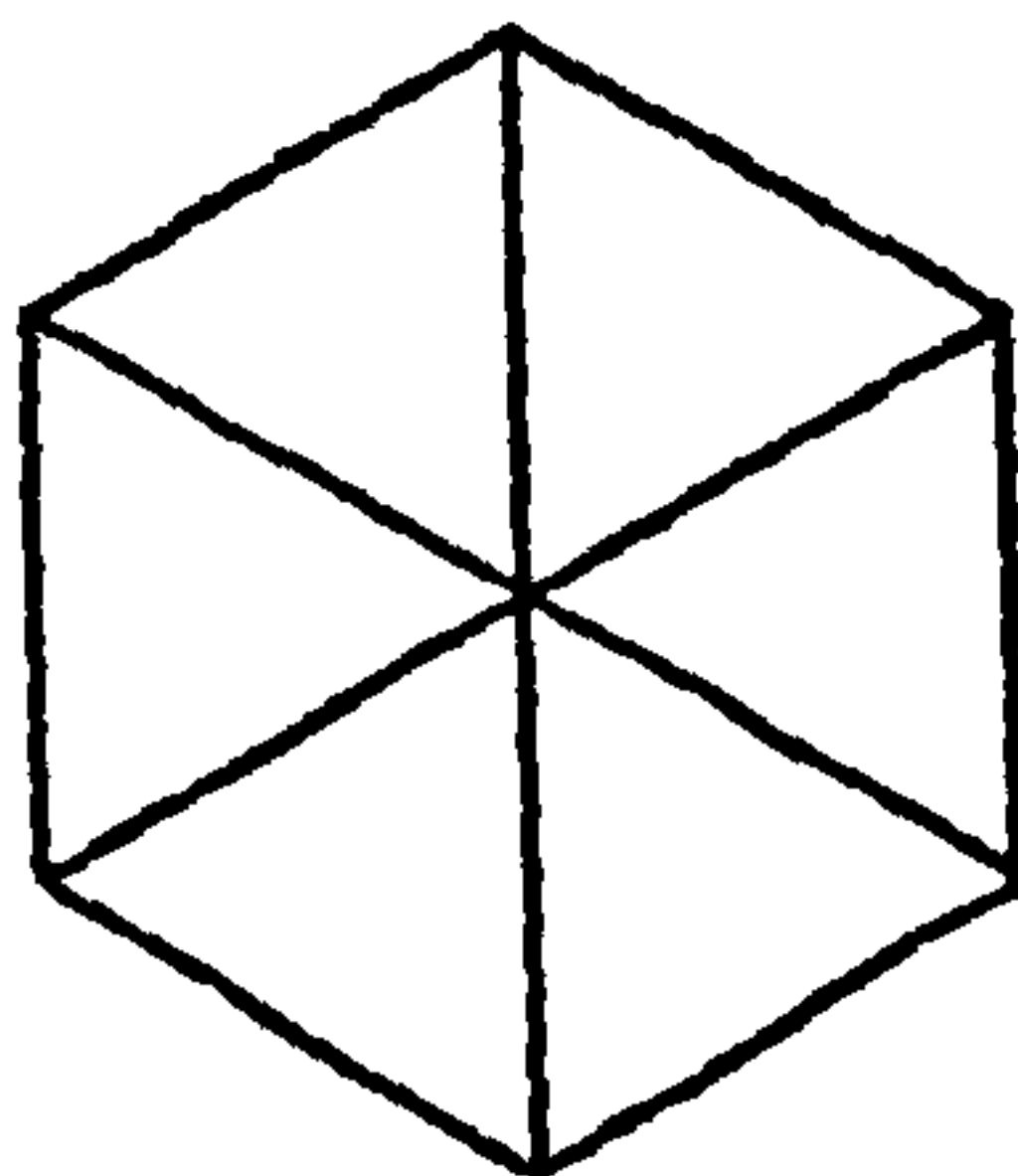

DRAW3D

Figure 5.7.2



from the final projection. DRAW3D which realises projections of objects, includes this clipping feature. The minimum distance before clipping occurs, is normally 1.0 inch, but this is adjustable to enable cross-sections of objects to be produced. Figure 5.7.2 shows views of a cone as the observer moves through its interior.

Hidden-line removal only occurs at the individual structure level, and is achieved by testing the sense of the vertices when a surface is projected onto the picture plane. If the vertex sense is found to be counter-clockwise, then it is being viewed from behind, and may be removed by the user. Figure 5.7.3 shows a cube and cone with and without hidden-lines removed. This feature requires initially that all surfaces are declared in a clockwise sequence, which is a PICASO convention.

Two simple methods are available for producing texture, and they are HATCH and STIPPLE. HATCH will draw a series of parallel lines within a PICASO shape at any angle or separation; STIPPLE will create a random pattern of dots inside any PICASO shape. Figure 5.7.4 shows examples of HATCH and STIPPLE.

Although it is assumed that PICASO structures consist of vertices joined by straight lines, it is very useful to be able to join them together with a smooth curve.

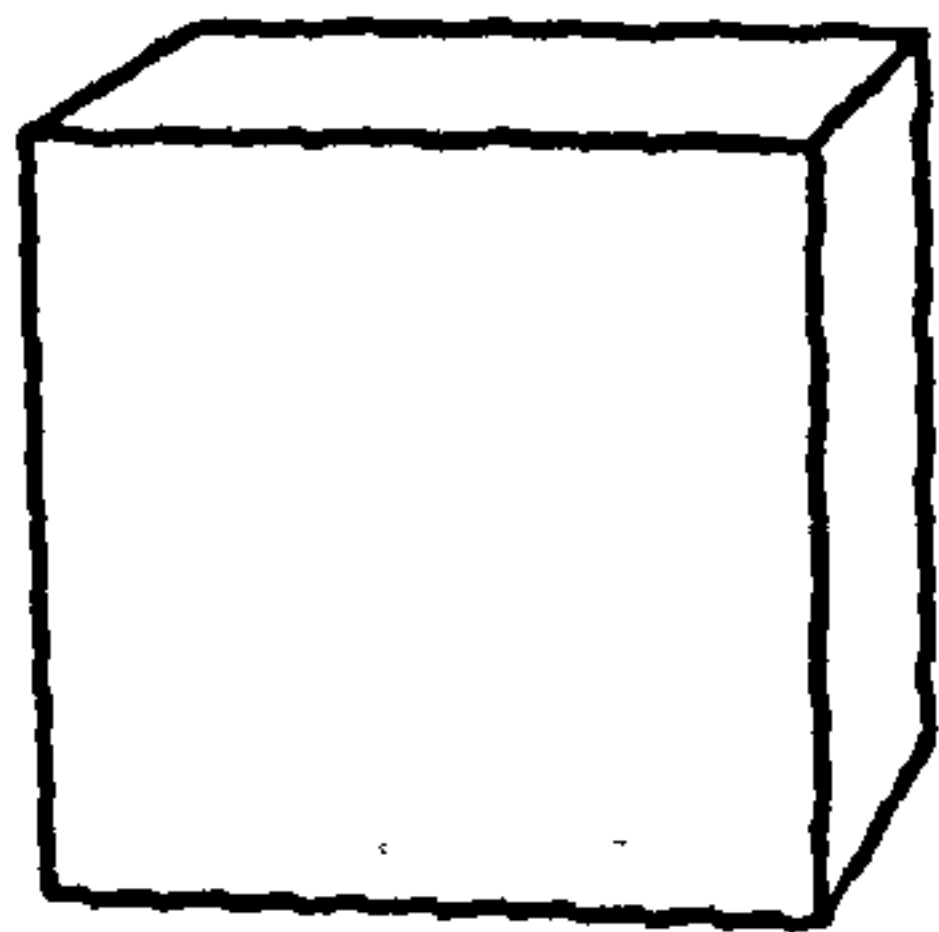
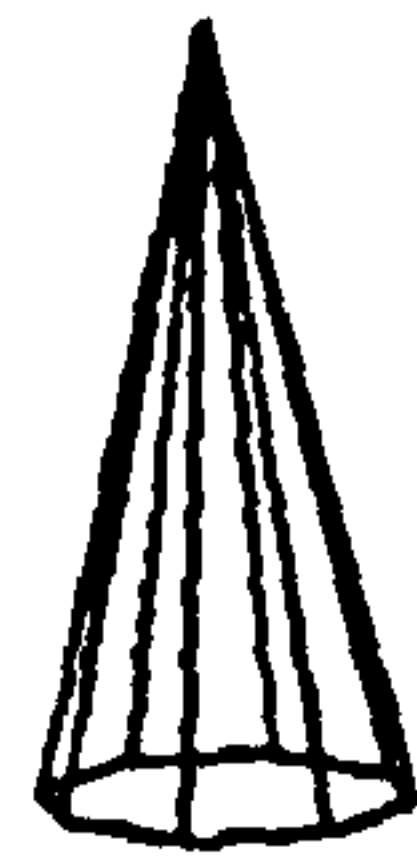
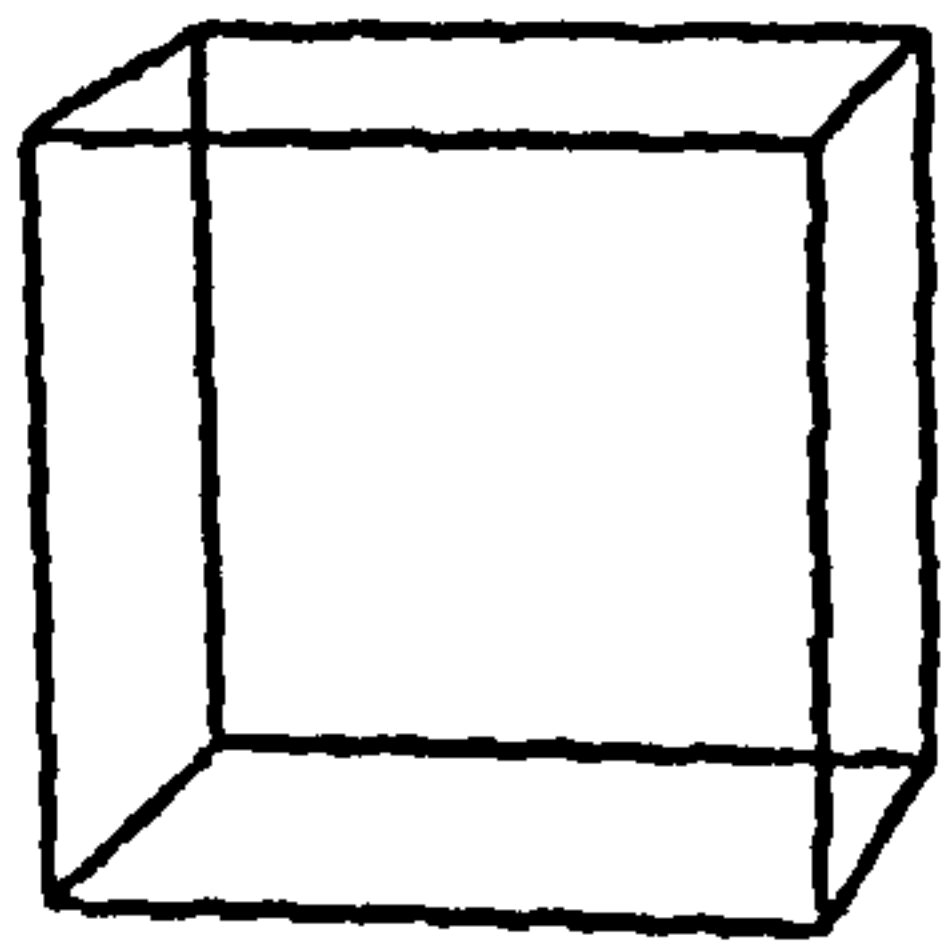

DRAW3D

Figure 5.7.3

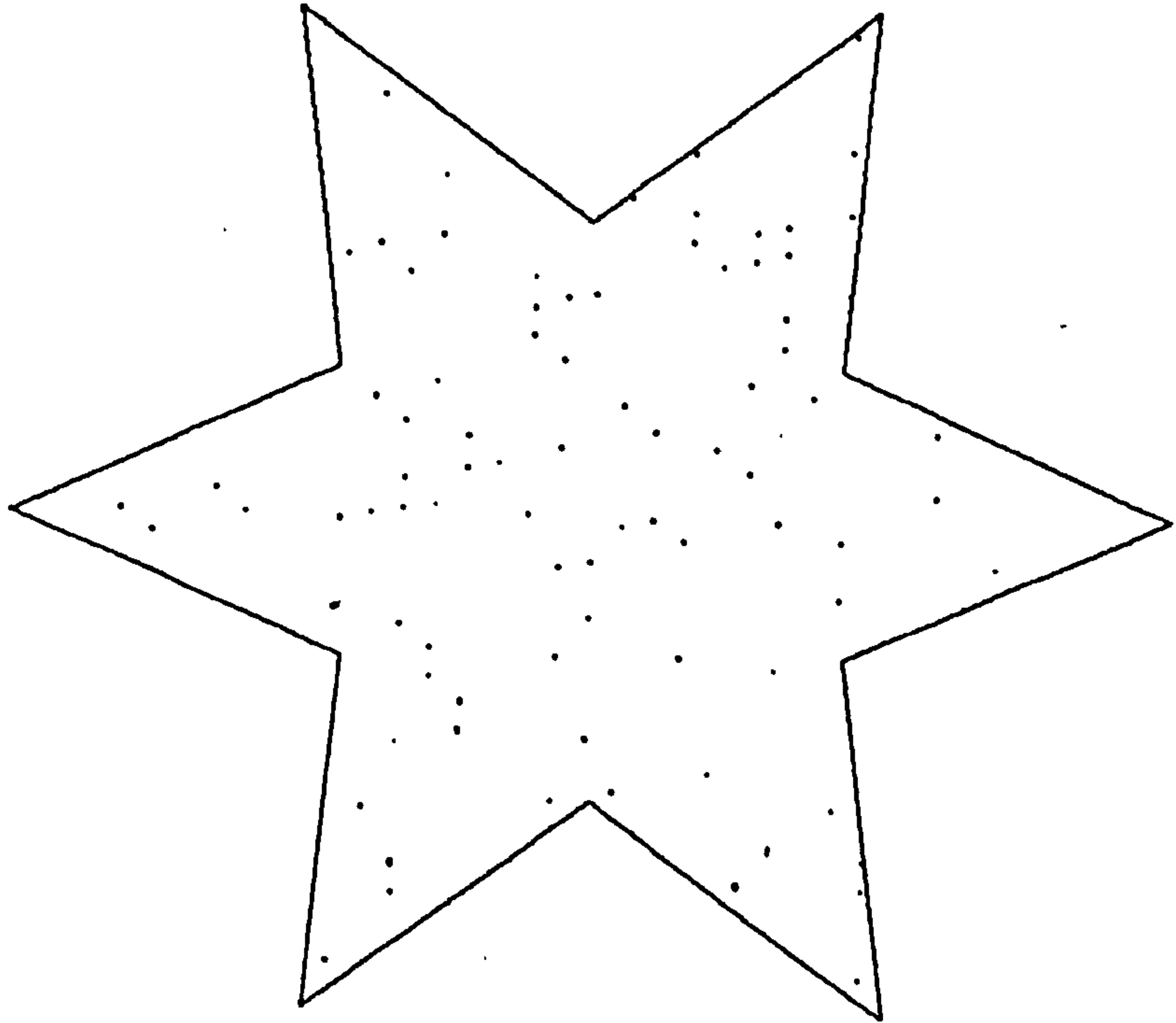

STIPPLE

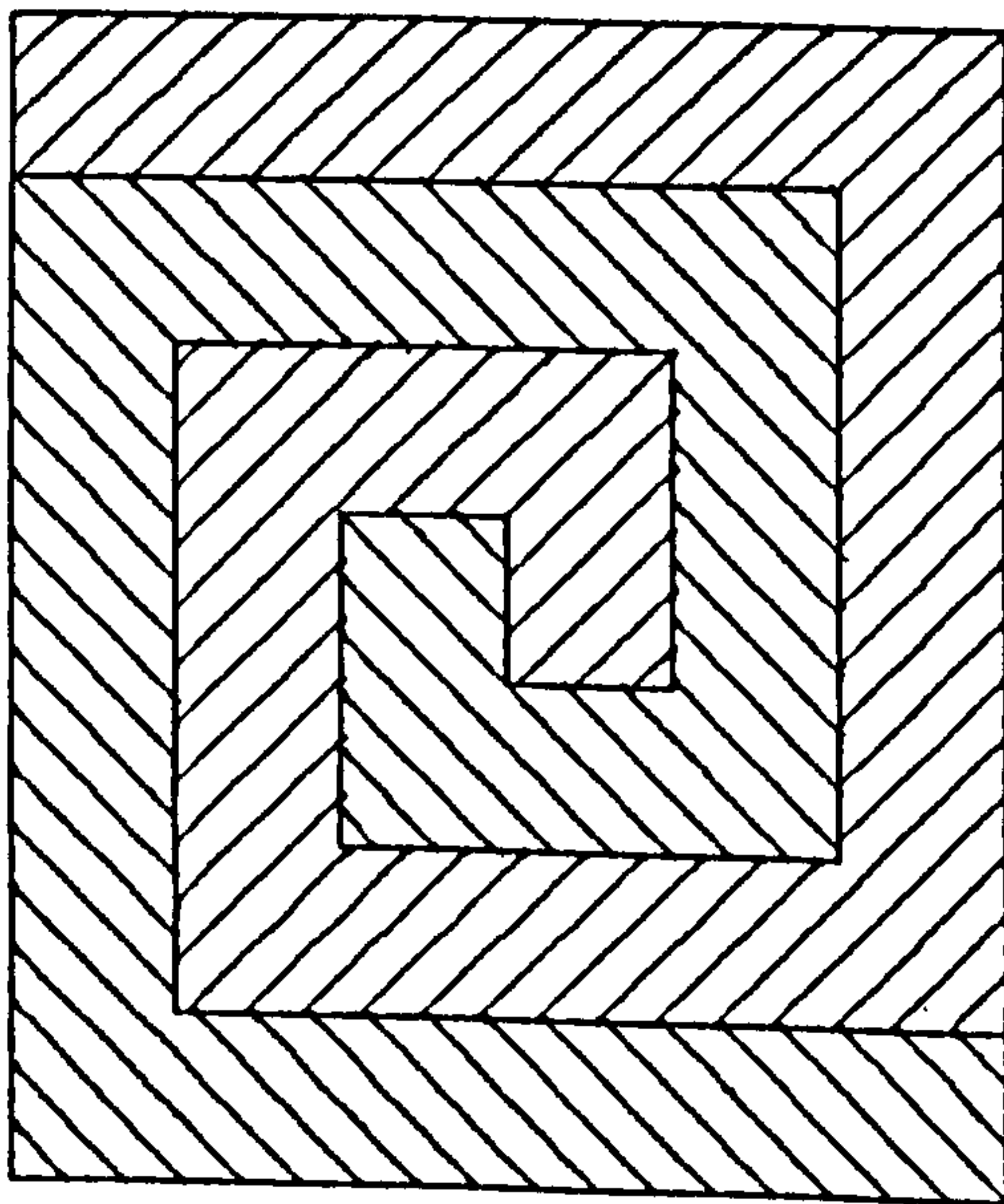

HATCH

Figure 5.7.4

(16)  
An existing algorithm was modified to accept the data structure of PICASO, which uses a cubic spline to join together vertices. This routine SMOOTH, works for open or closed contours and an example is shown in Figure 5.7.5.

A complete list of plotting commands is shown in Appendix VI.

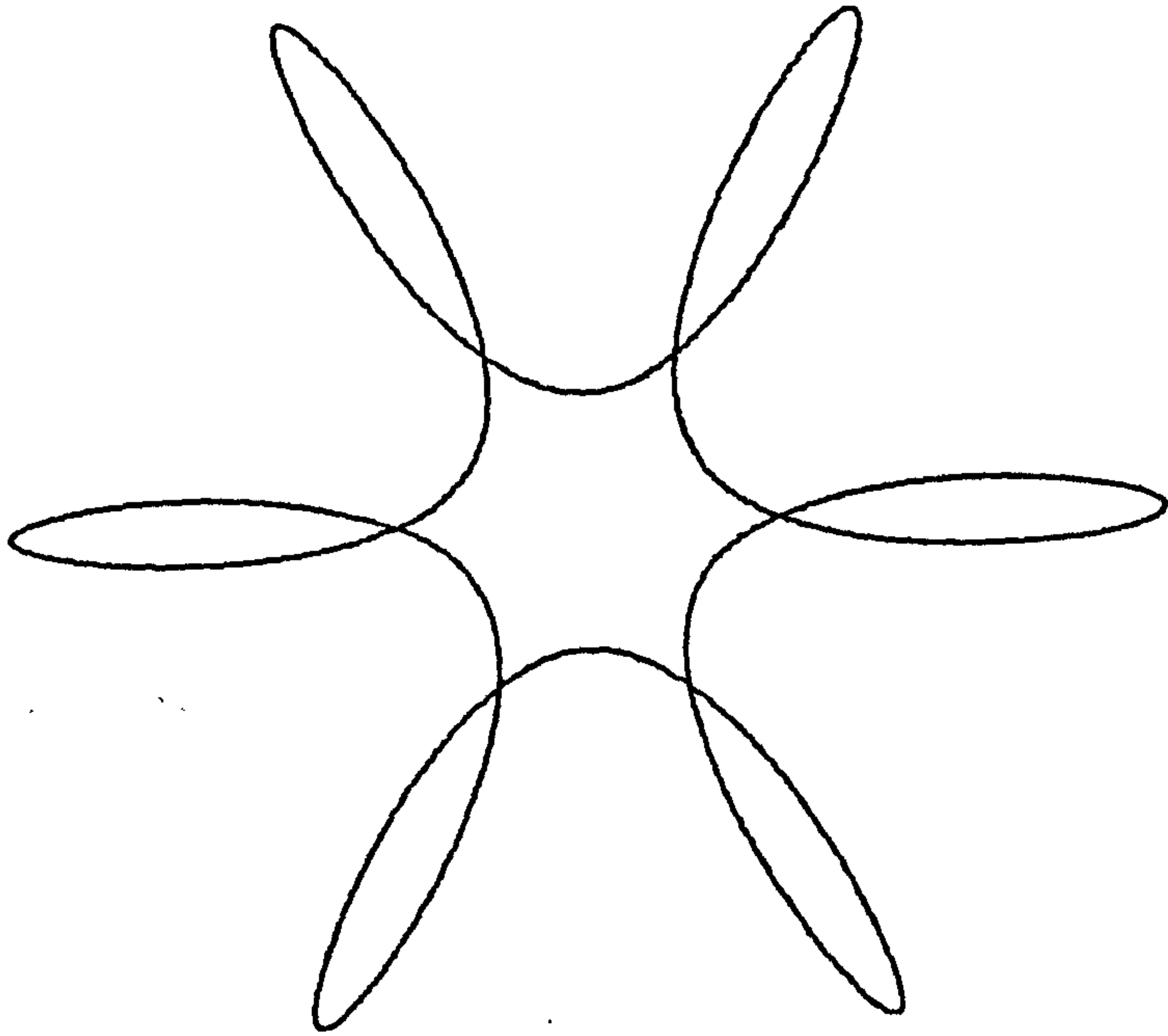

SMOOTH

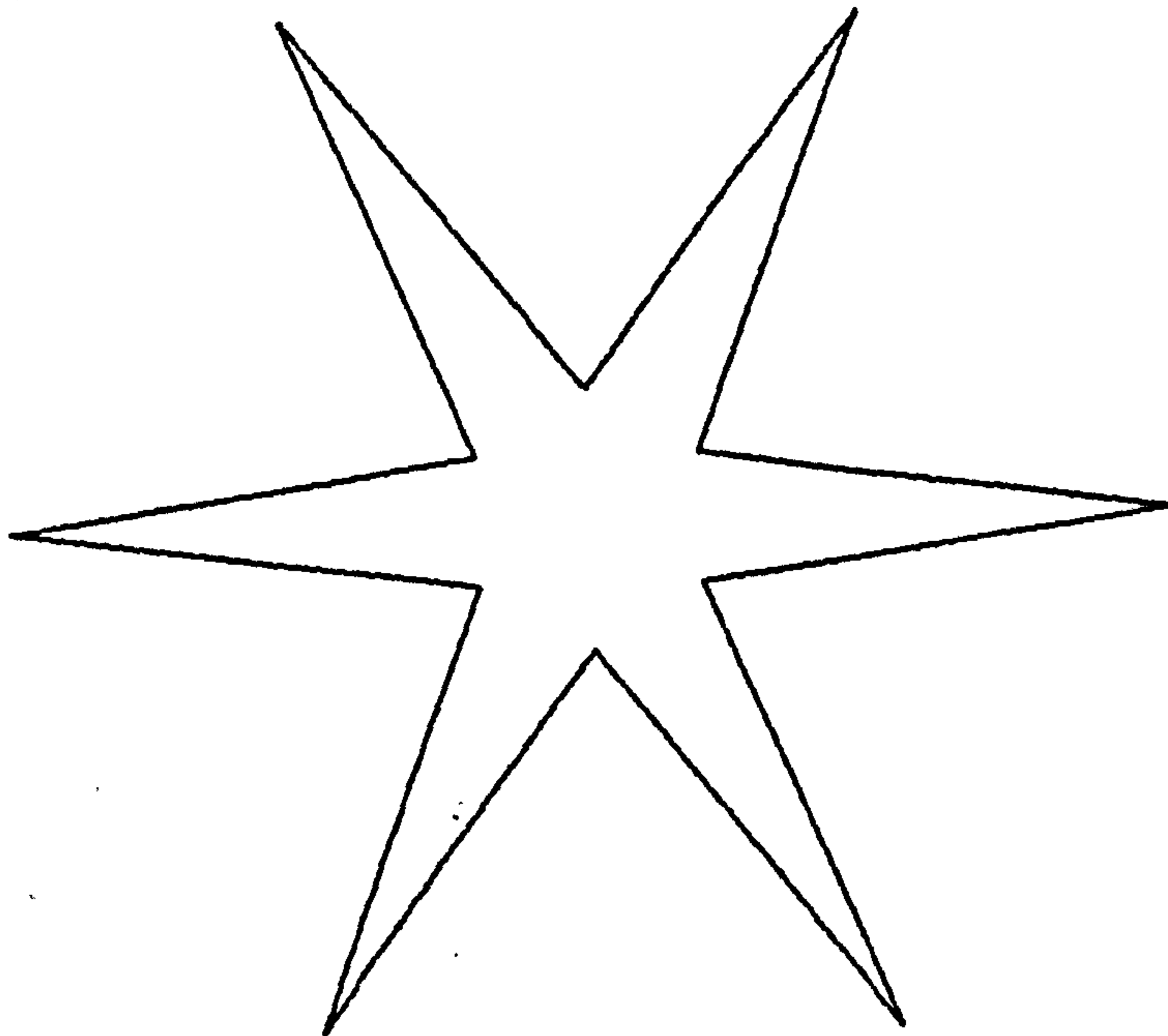

DRAW2D

Figure 5.7.5

## 5.8 PICASO STRUCTURE ANALYSIS COMMANDS

The analytical commands represent an important feature of PICASO in that they permit graphic problem solving in a non-interactive mode. It is not essential that all graphic programs have to engage the user in a real-time dialogue with the program, many types of problems may be solved by advance analysis which develops useful skills in problem solving, and can provide a deeper understanding to the problem area. Appendix VII contains the list of commands at present available in PICASO, but is expected to grow in content as other graphic effects are demanded.

The concept of inside and outside is quite important to many aspects of computer graphics, therefore, a special function was developed for PICASO, this is INSIDE. INSIDE is a logical function that returns a value of .TRUE. if a given point is found to be 'inside' a specified PICASO shape. The shape may be multiple-contour, and the vertex sequence of these contours is highly significant to the operation of INSIDE.

When a PICASO contour has vertices in a clockwise sense, INSIDE will be .TRUE. for all points 'inside' the contour, but for a counter-clockwise contour INSIDE will be .FALSE.. By altering the sense of contours with REVERS, the user is able to create

complex shapes that include holes. Figure 5.8.1 shows two systems of contours and the interpretation of inside and outside.

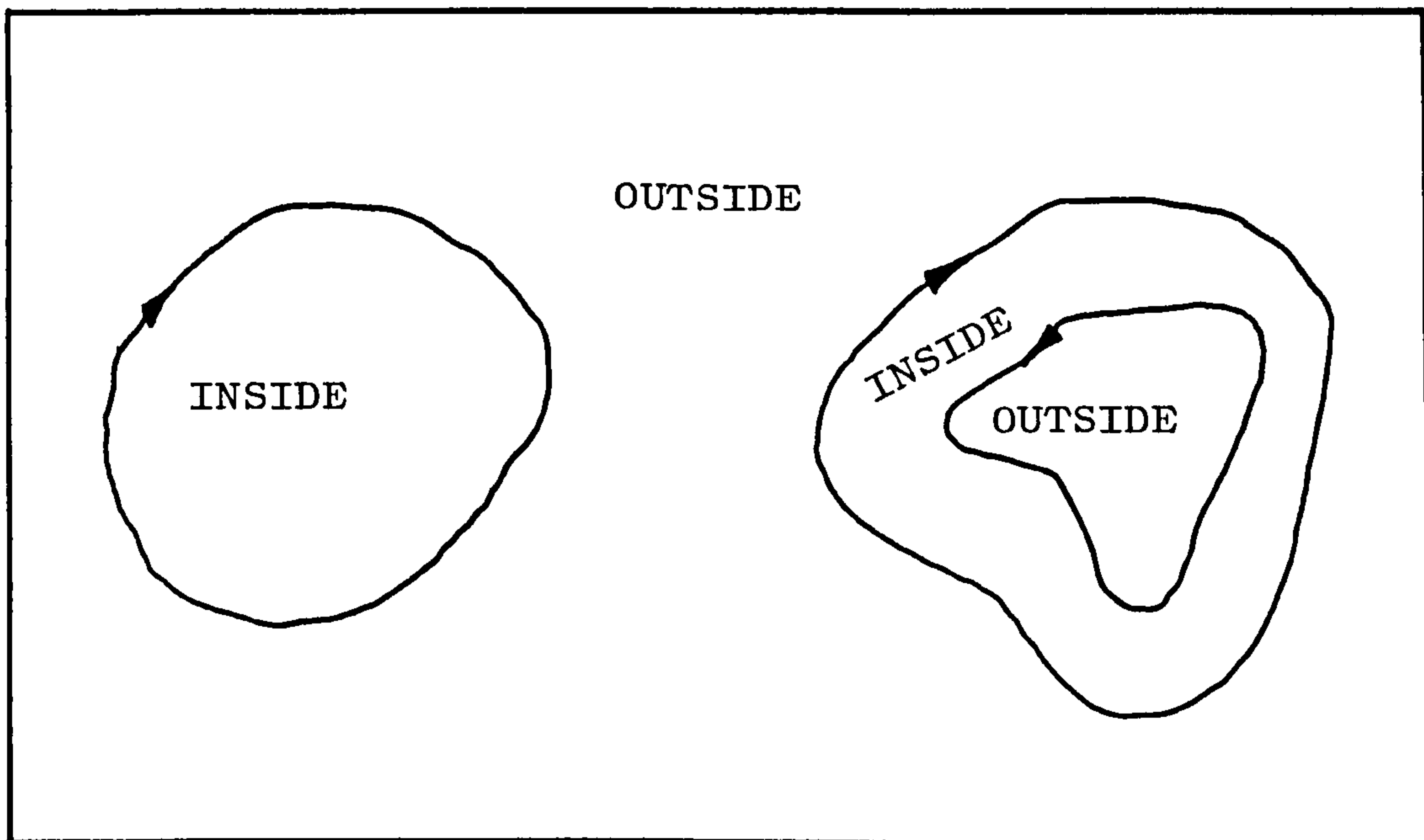

Figure 5.8.1

The two functions CLOCK and CLOK3D may be used to detect the vertex sense of 2 and 3-D contours respectively, and CLOK3D is actually used by DRAW3D to produce hidden-line removal. This type of function is very useful in software writing as it permits statements such as:

```
IF(CLOCK(A,1)) CALL REVERS(A,1)
```

which represents a powerful graphic operation.

Further shape and object analysis is performed by the functions:

NDIMEN which returns the dimension of the  
structure,

NLINES which returns the number of contours in  
a structure,

NPOINT which returns the number of vertices in  
a contour,

and the three general type functions:

XCOORD }  
YCOORD } which return the respective coordinate  
ZCOORD } of a vertex.

These permit the user to retrieve important  
characteristics of structures in conceptual space.



## 5.9 PICASO SURFACES

Computer drawn surfaces have always played a useful means of communicating large quantities of data effectively, they are also aesthetically pleasing to the 'artistic eye', and have already been used in computer art.<sup>(17)</sup>

PICASO includes a variety of simple ways of creating three-dimensional surfaces that may be exploited to create very effective graphic output.

There are basically three ways of simulating surfaces on a plotter or visual display. The first consists of reducing the surface to a number of parallel lines, the second divides the surface into rectangular tiles, and the third, shades the surface either with dots for the plotter, or alters the screen intensity for a graphic display. PICASO incorporates all three techniques, however the shading algorithms are still in the process of development.

The subroutine SURFAC uses the first technique of assembling a surface from a number of lines, and includes an effective hidden-line algorithm.

SURFAC produces a front-elevation view of a surface that is generated by spinning a PICASO open contour about some vertical axis. The user supplies information concerning the contour, position of

rotation, the angle of elevation etc, and SURFAC provides a realistic surface. Two such surfaces are illustrated in Figure 5.9.1.

The subroutine ISOMET generates a surface composed of rectangular opaque tiles viewed in isometric projection. Again the user supplies similar information as supplied to SURFAC, and the drawings in Figure 5.9.2 result.

The style of surface created by SURFAC and ISOMET is limited as they only permit symmetrical surfaces.

Consequently, two extra routines were developed to enable irregular line and tiled surfaces to be drawn, these are HIDE and ASOMET.

HIDE draws out one line supplying hidden-line removal based upon the previous lines drawn, and the user develops a surface by calling HIDE with new data.

ASOMET accepts a matrix of numbers, that represent vertical measurements on a surface at regular positions. From this, an isometric view is produced. An example is shown in Figure 5.9.3.

The isometric view is popular in computer graphics as it allows a simple algorithm to remove hidden-lines; a perspective view made from any point in space requires considerable execution time and memory.

However, a technique employed in SURF3D, breaks up a surface into rectangular tiles and then tests to see if it is seen. Although there are areas where the

surface remains transparent. It is still very effective. Figure 5.9.4 shows two views of the same surface, with and without hidden-lines.

Contour maps are extensively used in geographic problems, but were included in PICASO to complete the range of surface techniques.

MAP2D produces a plan view of a contour map whilst MAP3D realises a 3-D perspective view, with each contour in its true position in space. Data are supplied in the form of a matrix together with a range of heights to search for. Figure 5.9.5 shows how the same set of data is interpreted by the two programs.

Surfaces that form solid objects may also be created with equal ease by the subroutine SILUET. This develops a tiled opaque or transparent surface by rotating an open 2-D PICASO shape about a vertical axis, the resulting envelope creates the surface. Figure 5.9.6 illustrates various examples produced by SILUET.

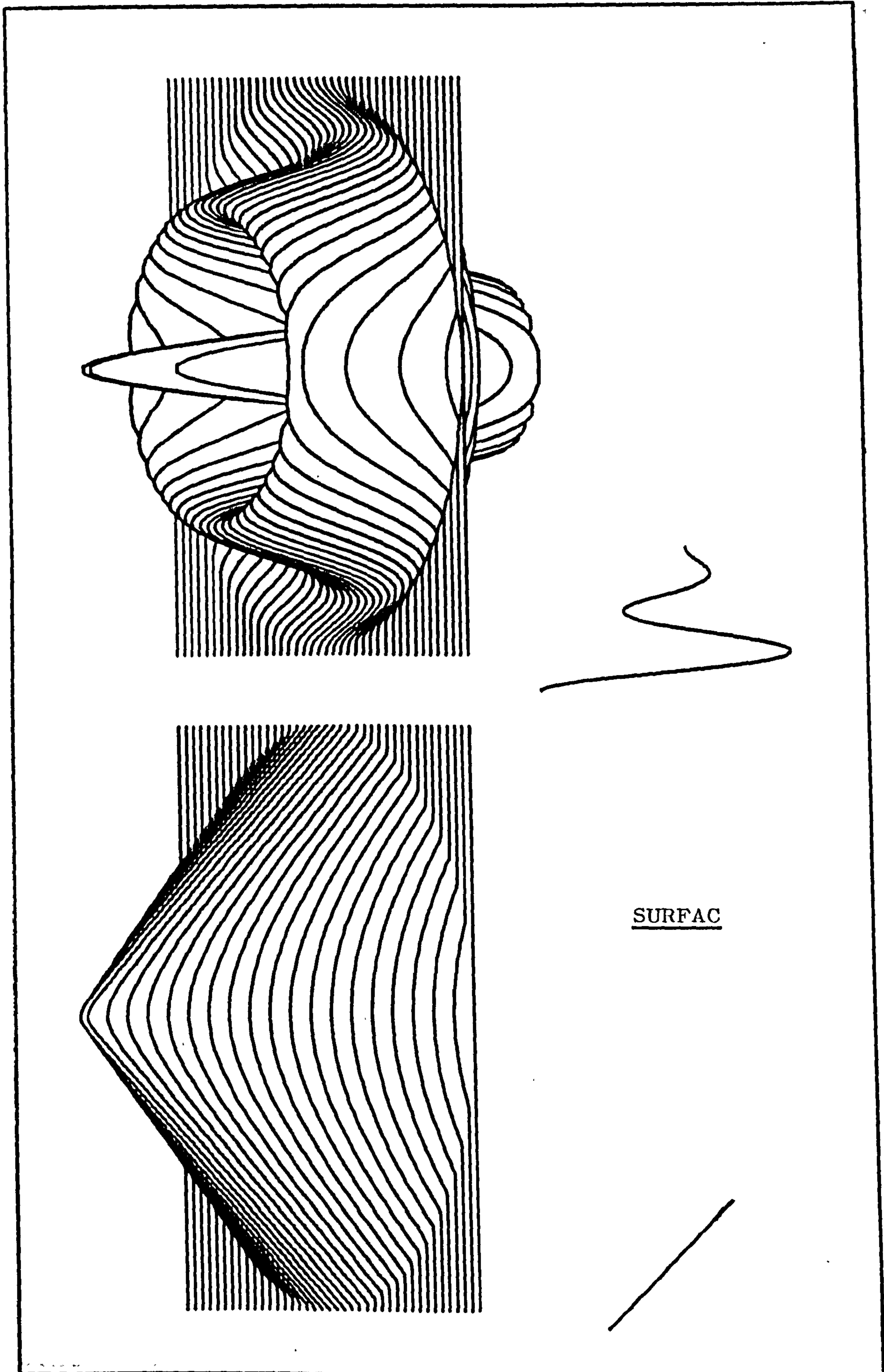
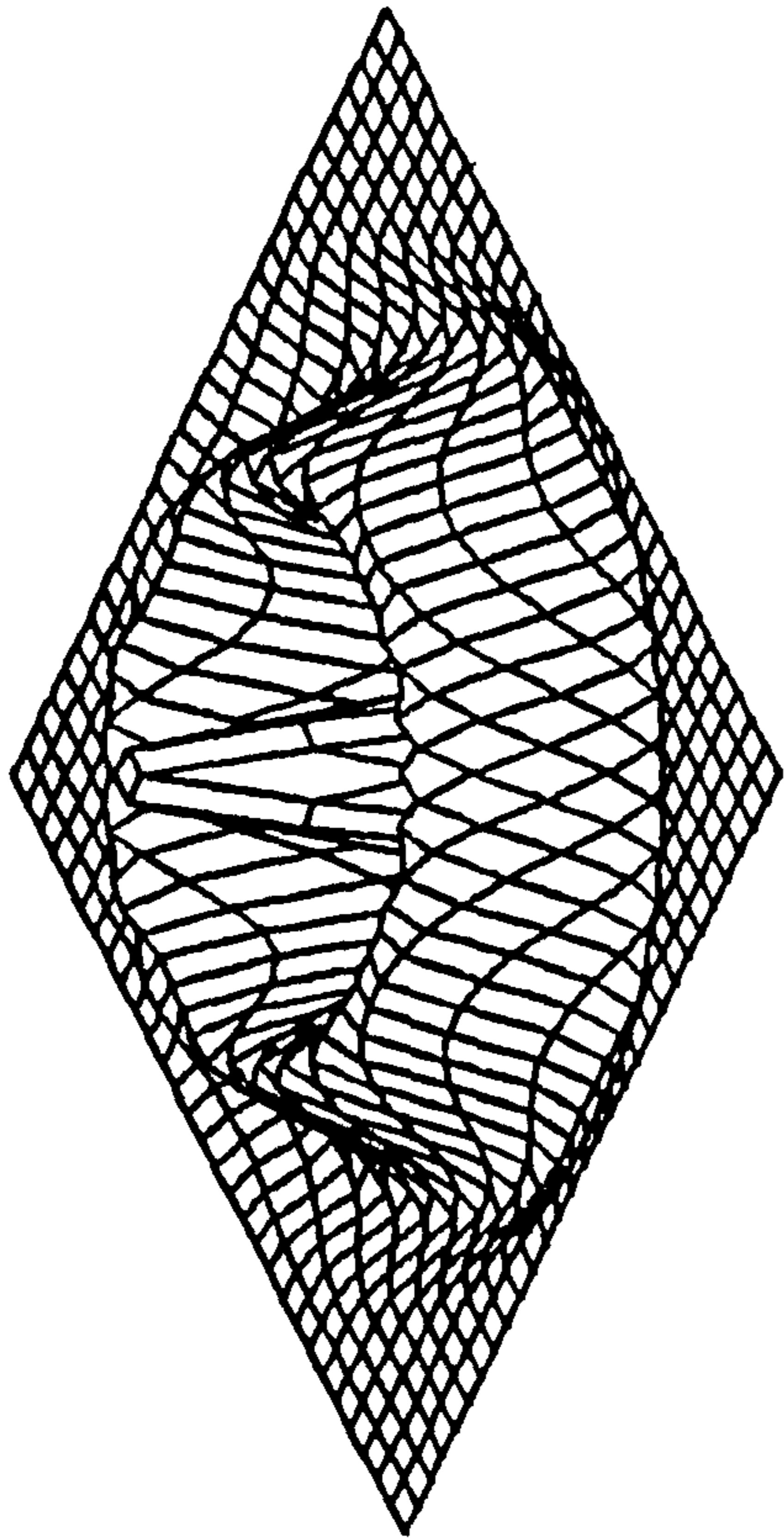

Figure 5.9.1



ISOMET

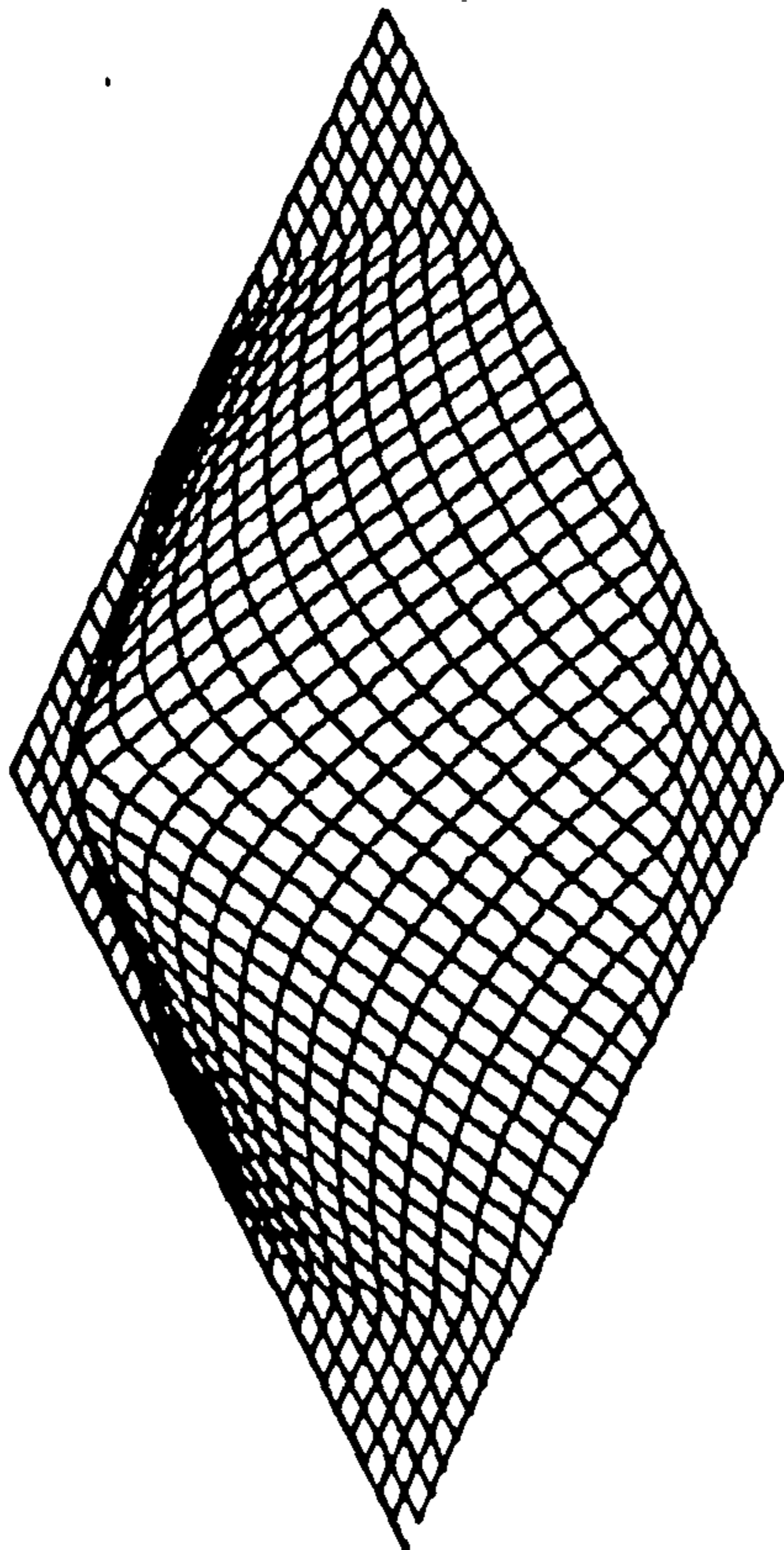
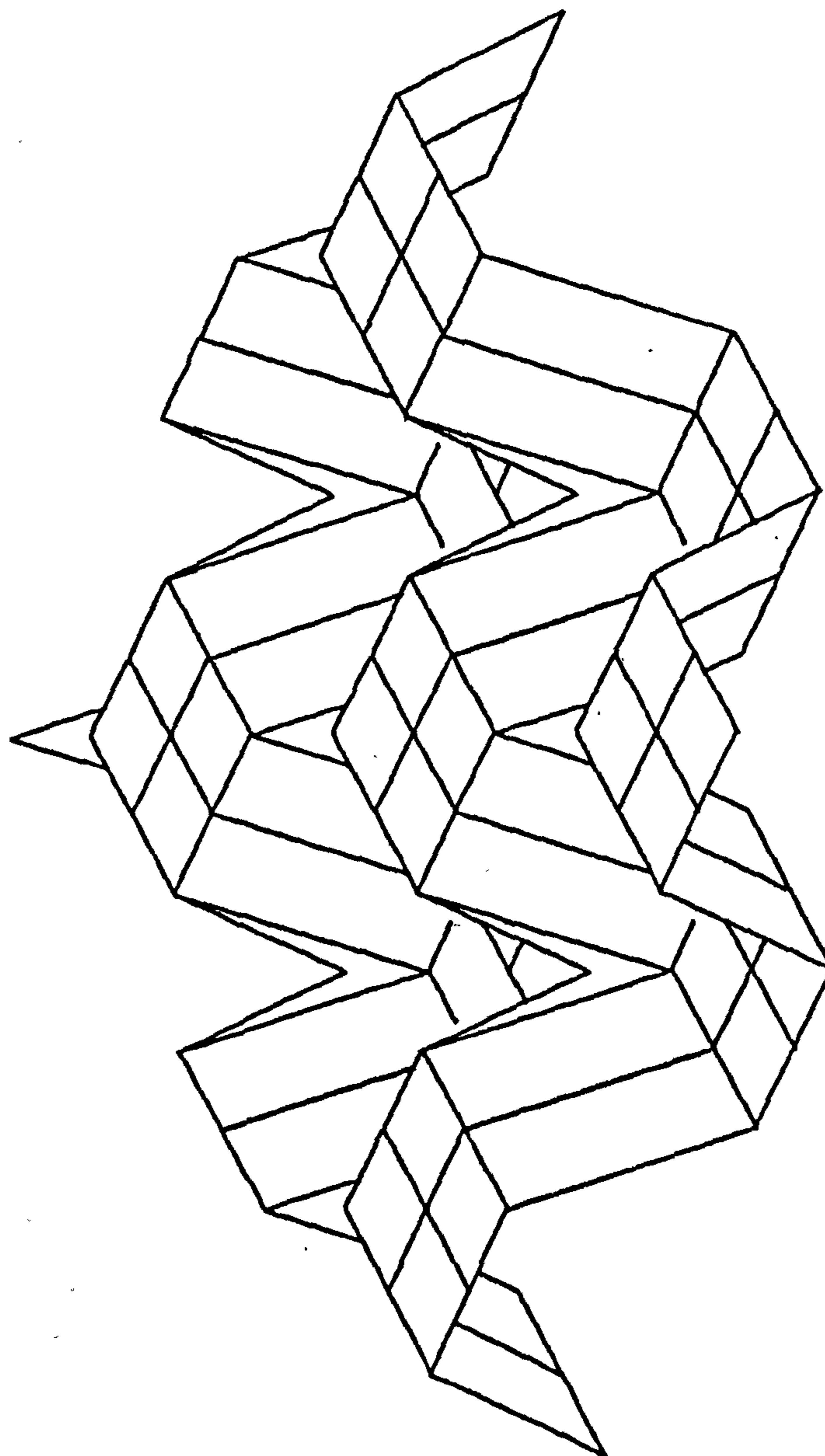
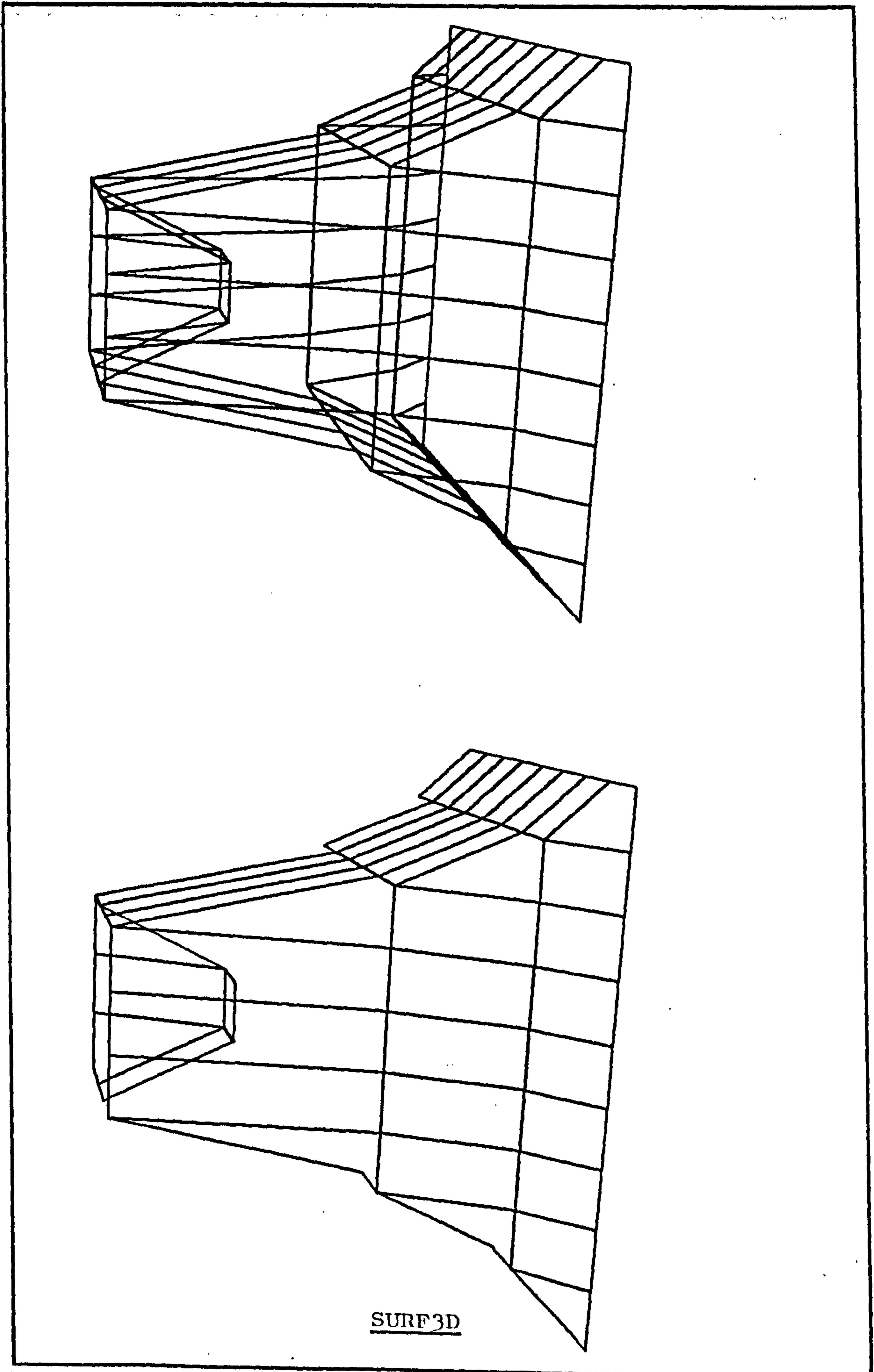

Figure 5.9.2



ASOMET

Figure 5.9.3



SURF3D

Figure 5.9.4

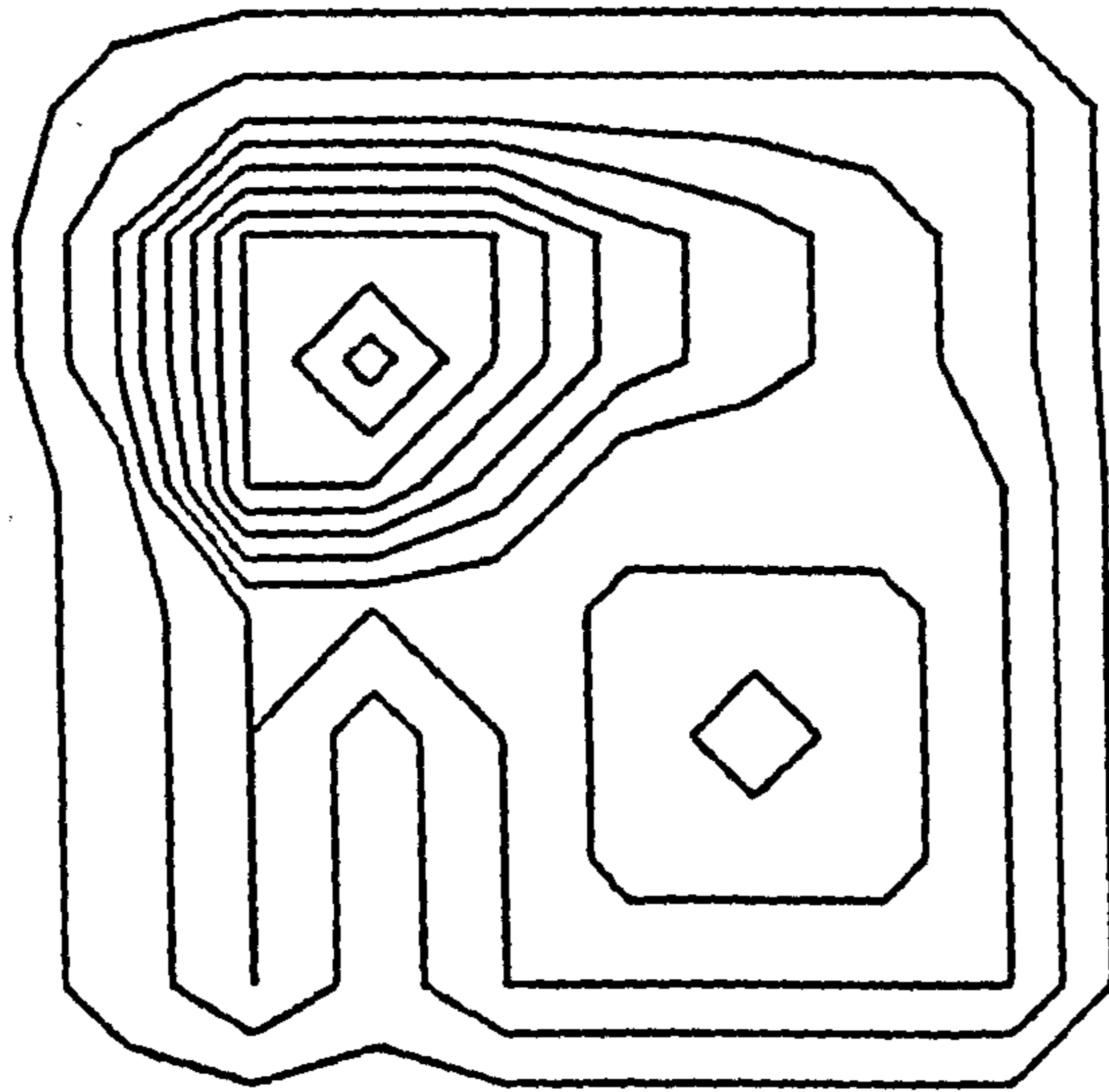

MAP2D

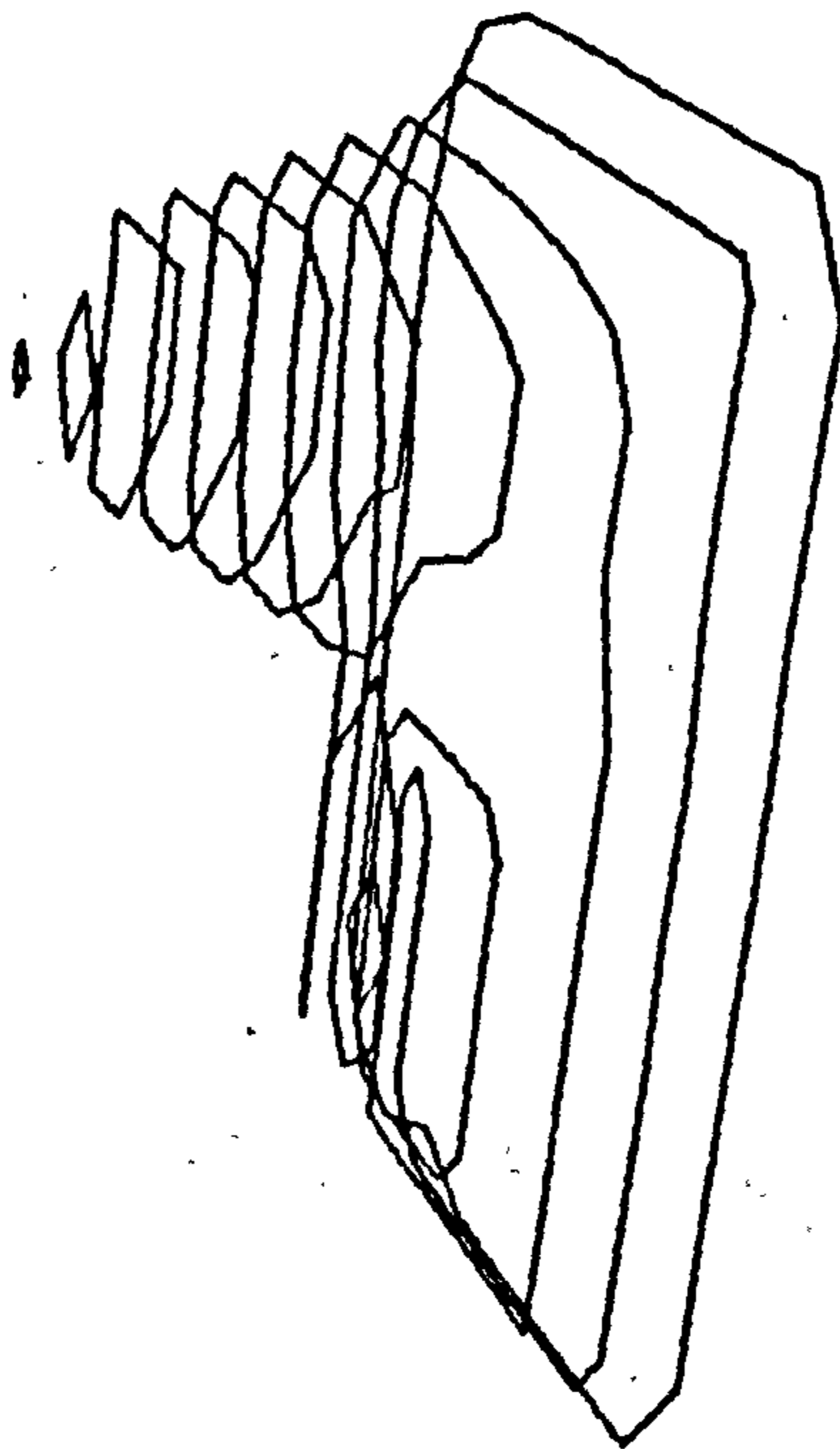

MAP3D

Figure 5.9.5



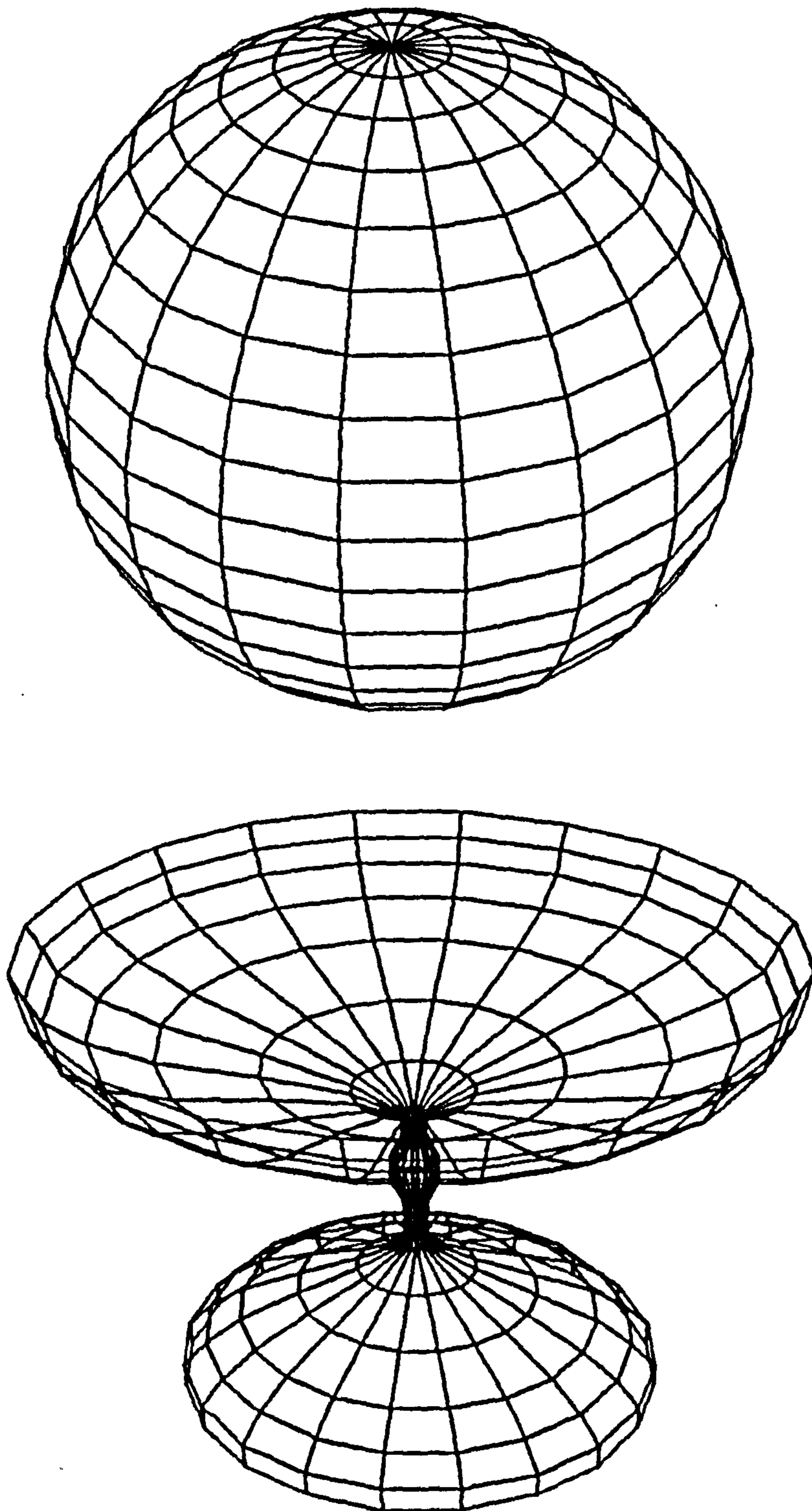

SILUET

Figure 5.9.6

### 5.10 PICASO SPECIAL EFFECTS

PICASO special effects are created by a series of subroutines that produce a final graphic effect, without the requirement of user programming. These are useful from an educational aspect when teaching the beginner, as programs consisting of no more than six statements can produce surprising graphic output. Perhaps the best example of this is the routine CONECT, which produces a popular example of computer art. CONECT accepts a PICASO shape and joins every vertex to every other vertex by a straight line. Two examples of CONECT are shown in Figure 5.10.1. A three-dimensional version CONEC3 performs the same operation on PICASO objects.

GROW, GROW2D, and GROW3D are a family of subroutines to simulate recursive growth patterns. In the 2-D mode (GROW), a shape is drawn, and the same shape is drawn at every vertex of the original shape; this process may be continued to any depth, but excessive execution time dictates a final limit. Figure 5.10.2 shows a pentagon 'grown' to a depth of two.

MODSH is derived from the words 'modulate shape'. This performs a substitution process on a PICASO shape by replacing a line joining two vertices by an open 2-D PICASO contour, creating a simple modulation effect. The process may be repeated to a

depth that is dictated by available memory space. Figure 5.10.3 shows the result of modulating a hexagon by a parabola.

SNOW is another type of recursive program which turns every line joining two vertices into a small 'snow-flake'. The process may be repeated to any depth, but requires enormous amounts of processor time when the shape is large and the depth exceeds four. Figure 5.10.4 shows an original five-pointed star and a snowflake version grown to a depth of three.

These subroutines are only written as an aid to the beginner, but it is clear that they will grow in number as future demands are made upon the system

A complete list of subroutines is given in Appendix IX.

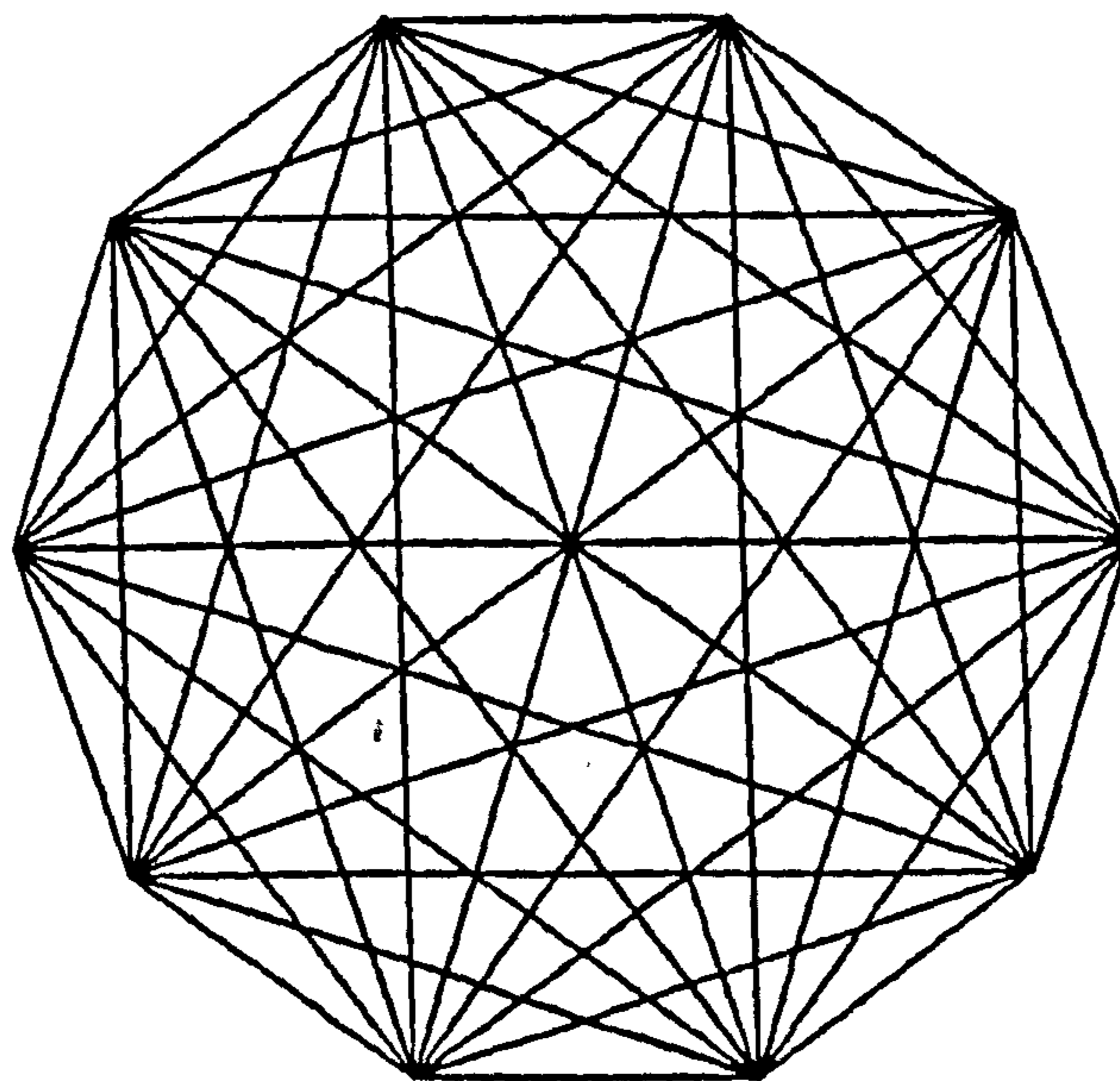
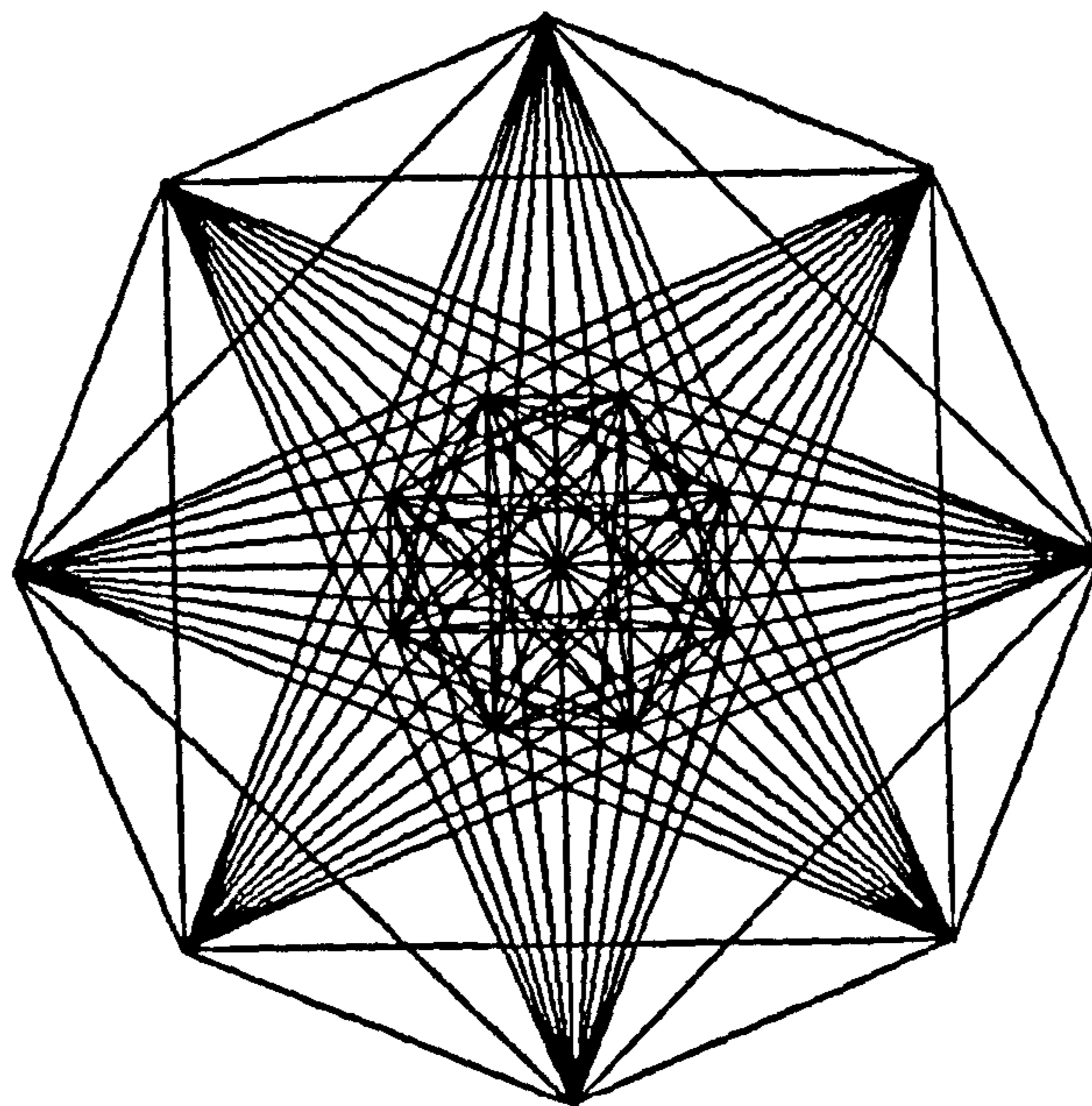

CONNECT

Figure 5.10.1

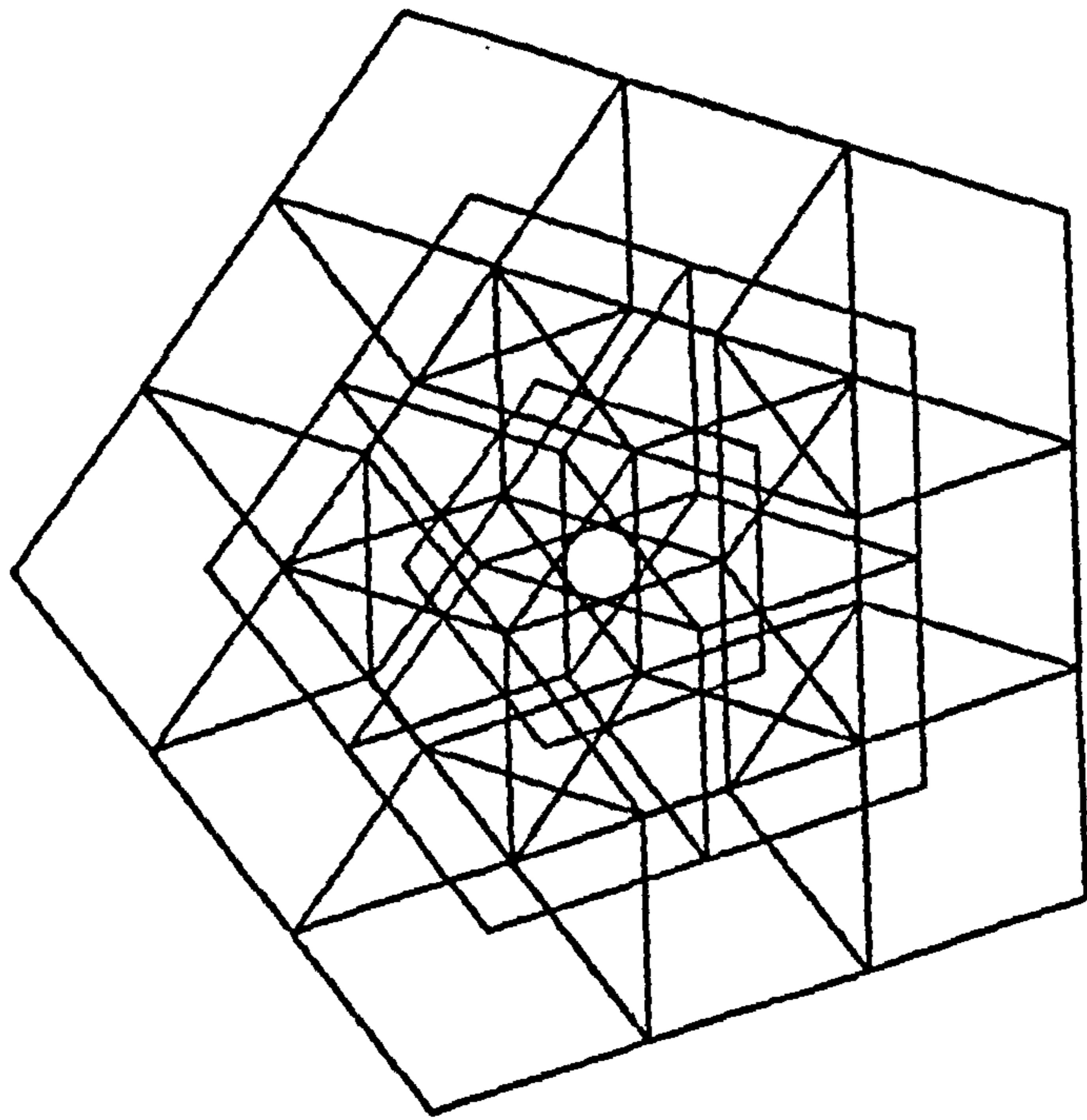

GROW2D

Figure 5.10.2

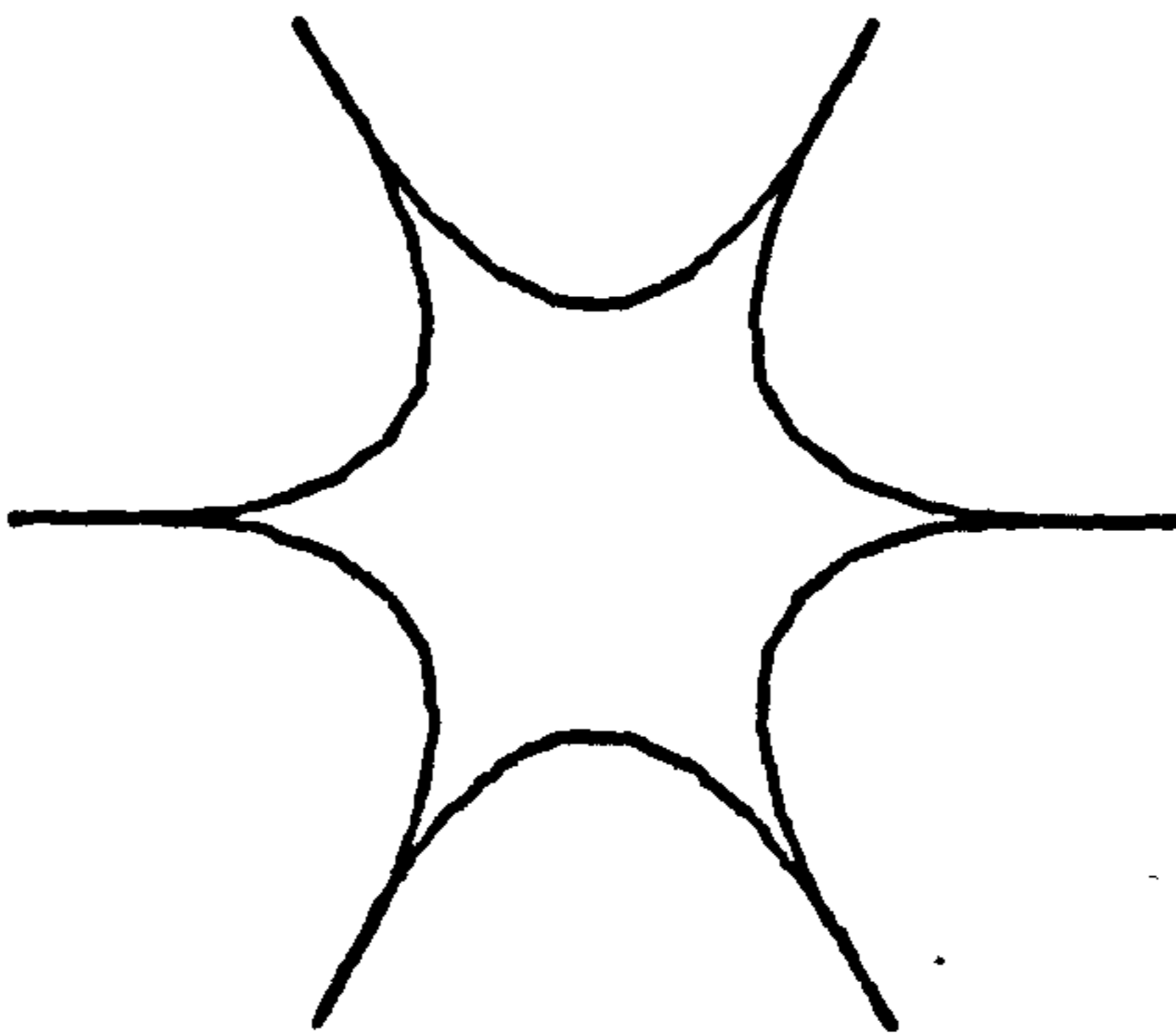
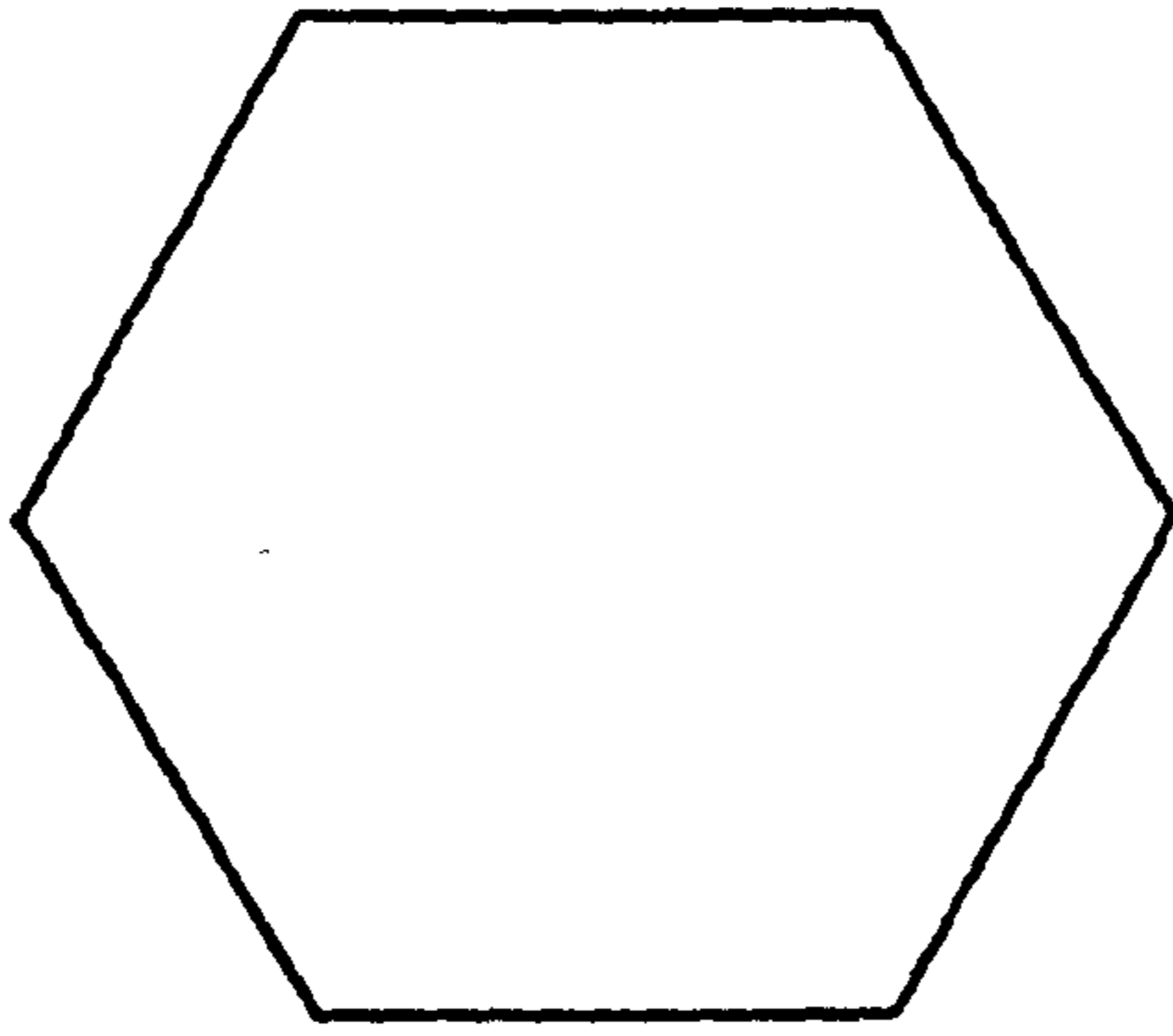

MODSH

Figure 5.10.3

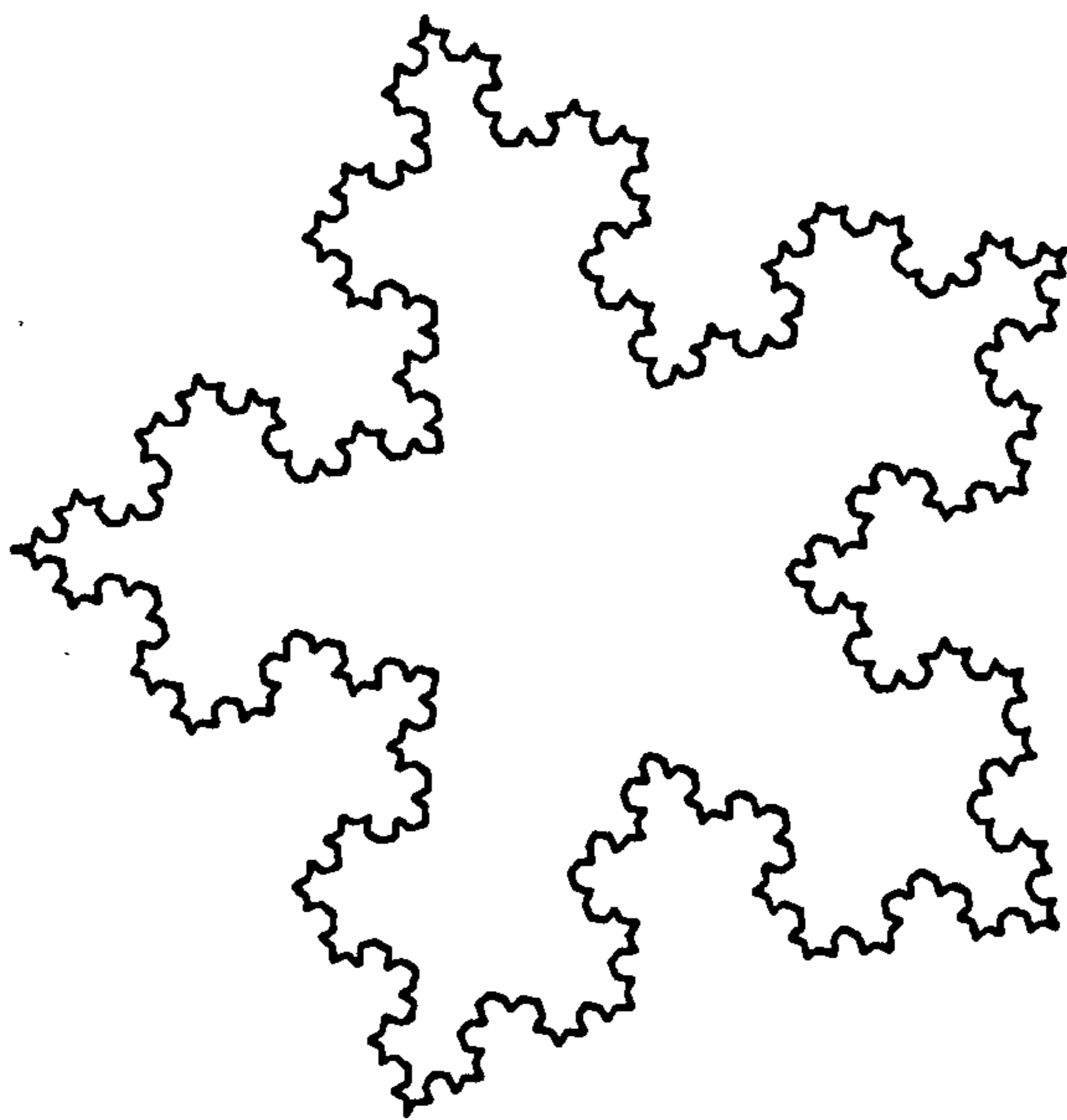
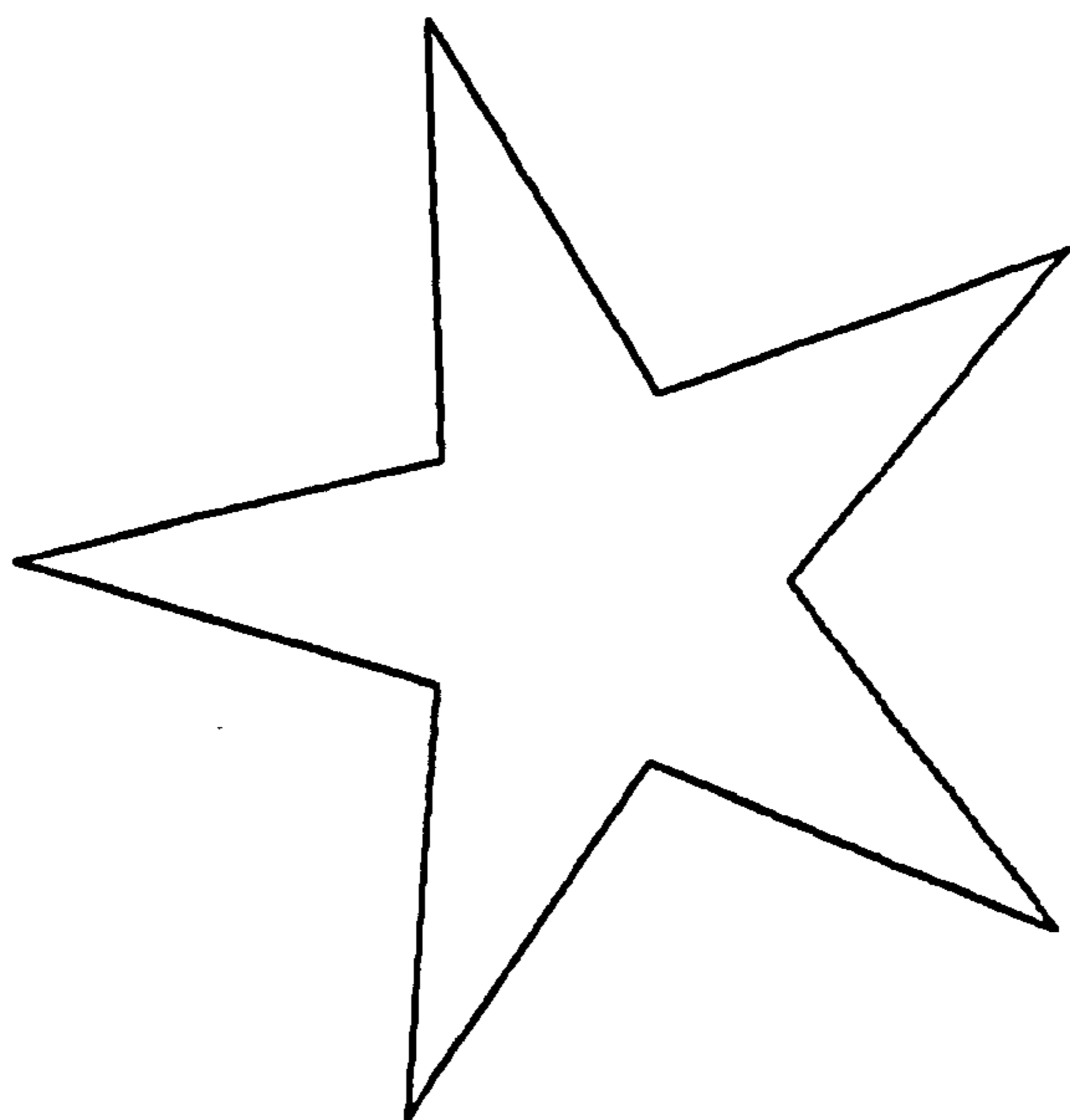

SNOW

Figure 5.10.4

### 5.11 PICASO FUNCTIONS

Generally, students learning to use PICASO tend to experiment with the structure handling routines before working with functions. Functions are only normally used when conventional methods break-down, or an effect relies entirely upon their use.

The majority of the functions are related to shape generation, and duplicate the shapes contained in the PICASO shape library. The functions always begin with an X or Y, for example XPARAB & YPARAB identify the coordinates of a particular point on a parabolic curve. When three dimensional trajectories are required, they may be created from combinations of these generators. For example, a 3-D spiral could be formed from a 2-D Archimedean spiral (XASPIR & YASPIR) and a line (XYZLIN), the actual orientation in space would depend on how the functions were assigned to the axes of space.

To maintain user mathematics at a bare minimum, the functions are supplied with general characteristics of the shape together with the vertex required relative to the total number of vertices on the shape, e.g. the third vertex out of 20. This procedure is found to work very well in practice.

Other functions include TAKE and ITAKE which return



a pseudo-random REAL or INTEGER number respectively from a specified range. These functions are useful when a random element is needed to control the size and position of structures in space. An example is shown in Figure 5.11.1 which illustrates a wide-angle view of cubes with random size and position in space.

A complete list of functions is shown in Appendix VIII.

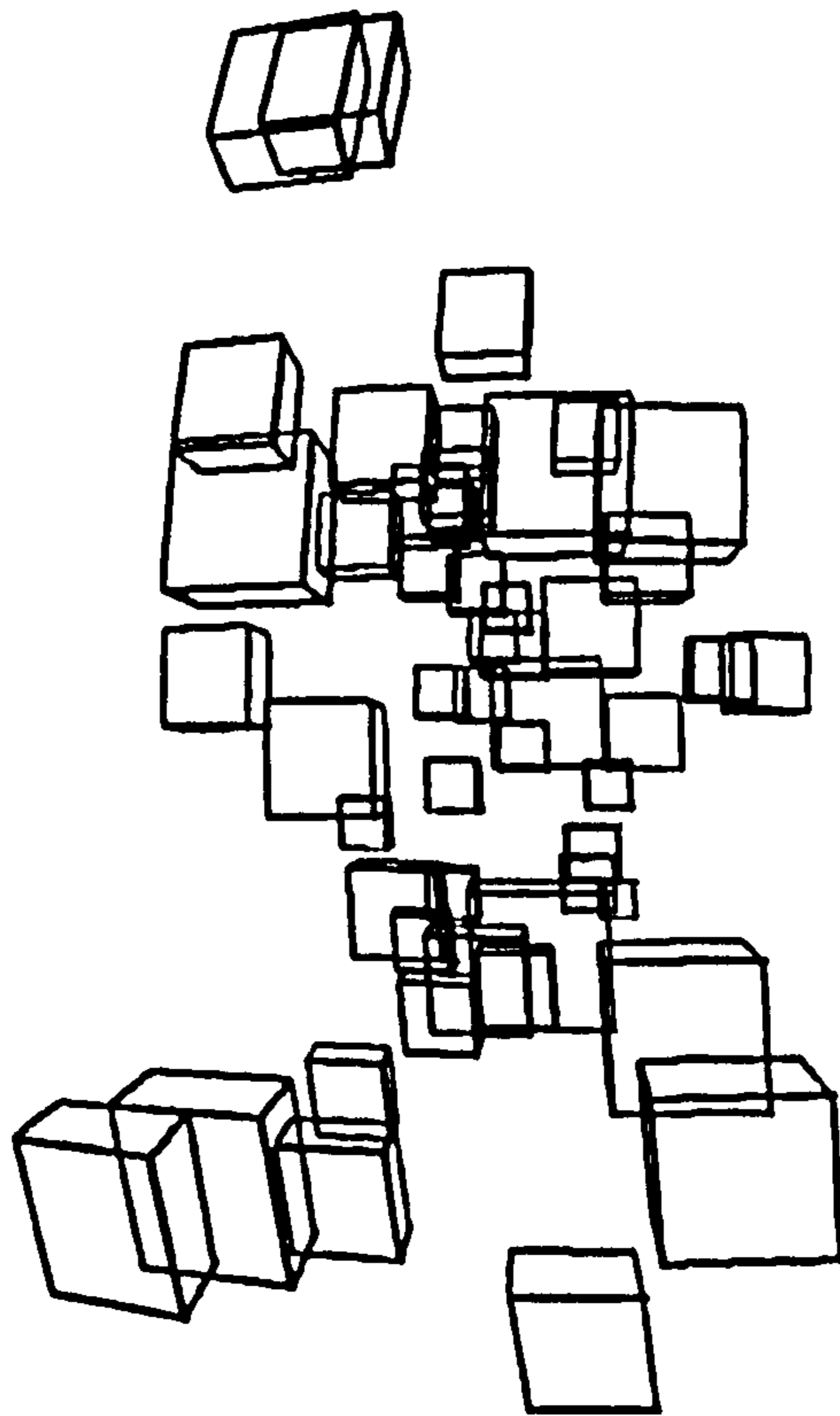

TAKE & FISHI

Figure 5.11.1

## 5.12 PICASO ARRAY HANDLING COMMANDS

The majority of FORTRAN compilers only permit 2-D arrays. This was regarded as a severe limitation to a graphics language, that worked in a three dimensional mode. Consequently, an entire range of subroutines and functions was designed to access and initialise one, two and three-dimensional REAL, INTEGER and LOGICAL arrays; these are listed in Appendix X.

## 6 EXAMPLES OF PICASO PROGRAMS

This section is concerned with the practical aspects of PICASO, but as it is impossible to explore every facet of the language various small programs have been written that illustrate typical graphic output.

### 6.1 EXAMPLE OF THE 2-D LIBRARY

An Archimedean spiral has been chosen to illustrate the multitude of effects that can be realised with just one basic curve.

The format for the spiral is:

```
CALL ASPIRA (ARRAY, RADIUS, CYCLES, N)
```

where:

```
ARRAY   is the name given to the spiral
RADIUS  is the final radius of the spiral
CYCLES  is the number of convolutions
N       is the number of points on the
        spiral.
```

An example could be:

```
CALL ASPIRA (SPIRAL, 2.0, 4.0, 201)
```

This statement generates an Archimedean spiral SPIRAL, consisting of 201 points, with four convolutions and a final radius of two inches.

If the user wanted to actually plot out this curve, the following program would be required:

```
DIMENSION SPIRAL(405)
CALL START
CALL ORIGIN(5.0, 5.0)
```

```
CALL ASPIRA(SPIRAL,2.0,4.0,201)
CALL DRAW(SPIRAL,1.0,0.0,0.0)
CALL FINISH(10.0)
STOP
END
```

and the output would be as shown in Figure 6.1.1.

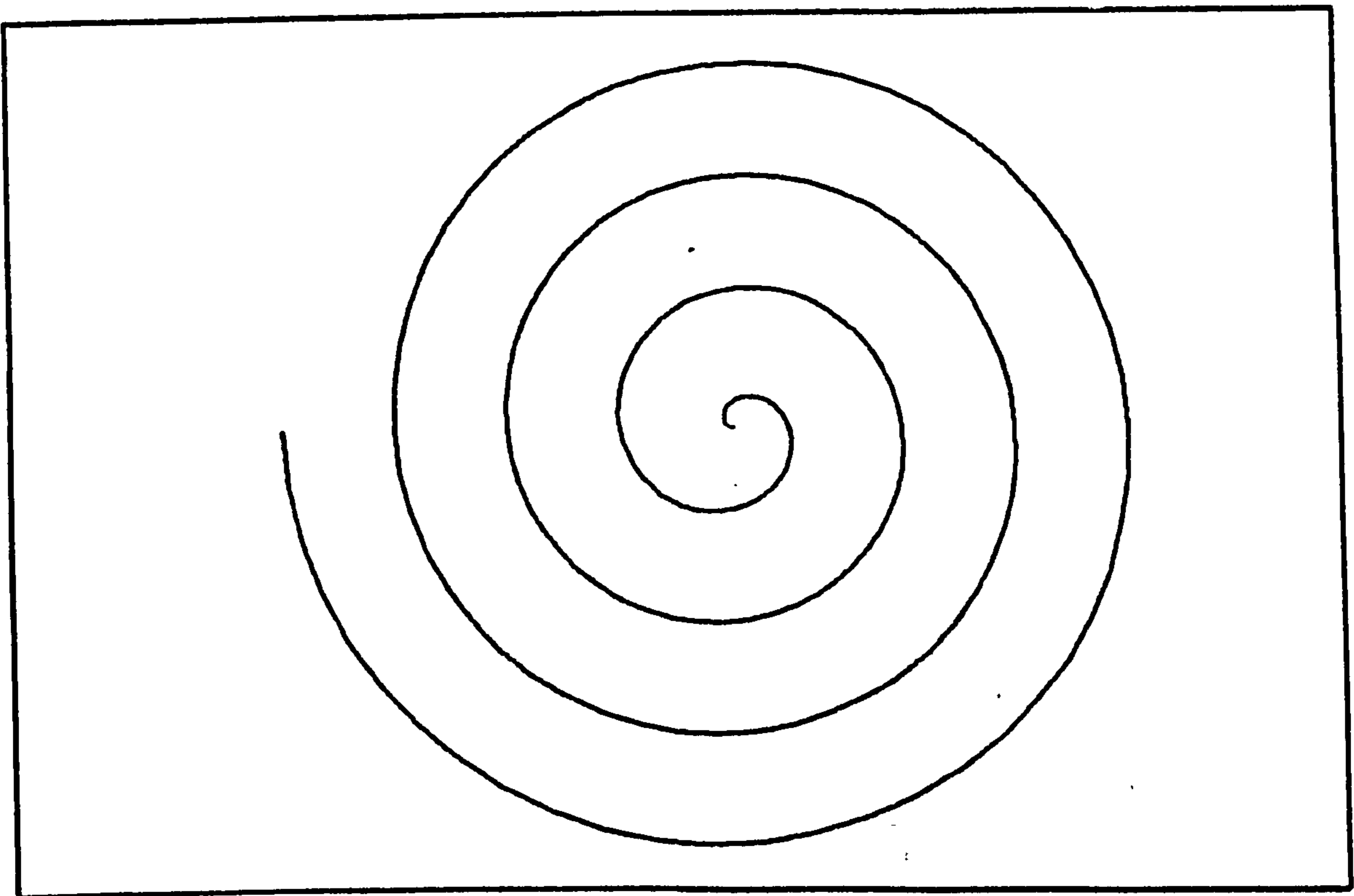
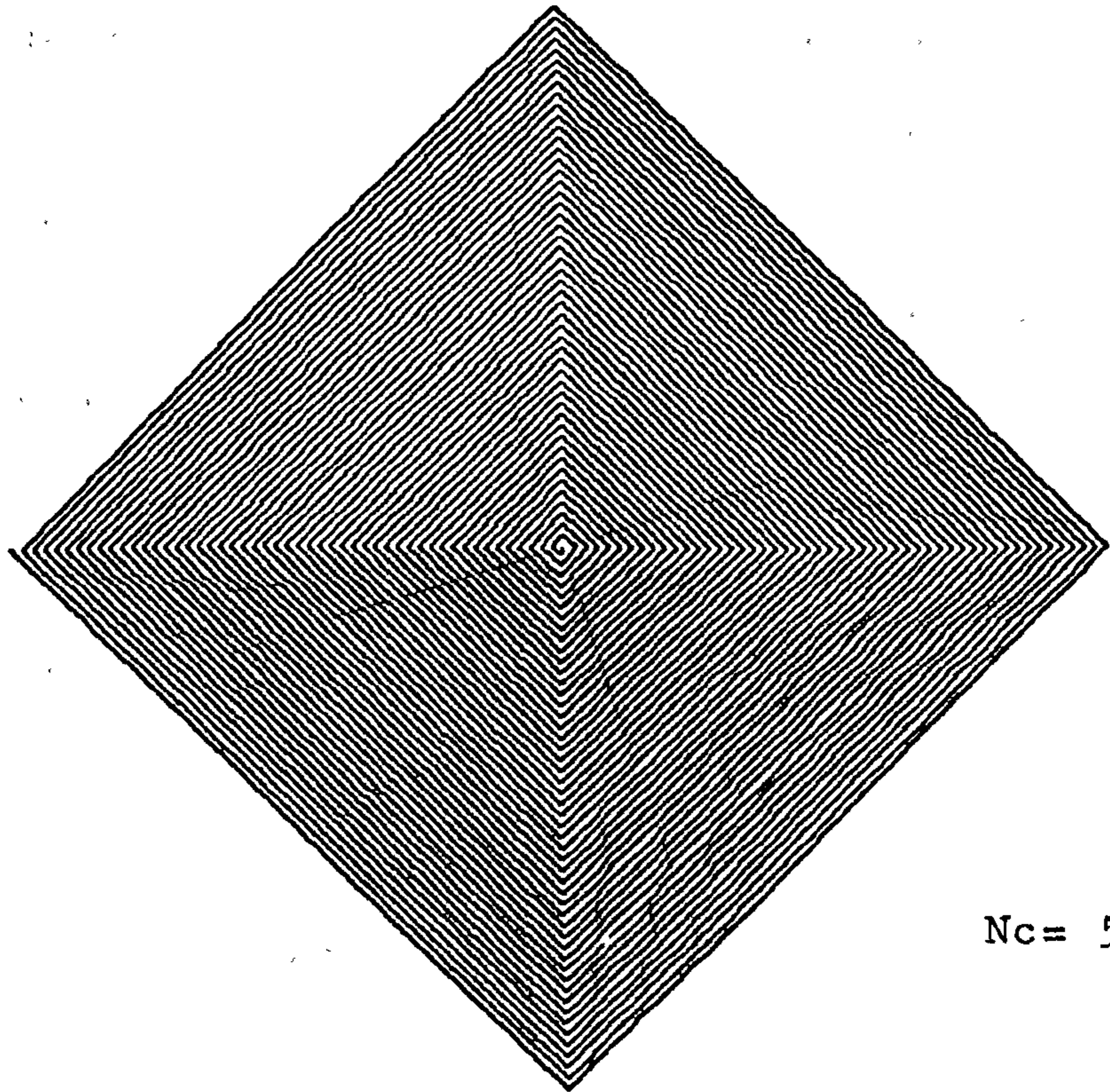

Figure 6.1.1

A slight modification to this program produces the examples shown in Figure 6.1.2. The actual change is in the number of convolutions.



$N_c = 50$

ASPIRA

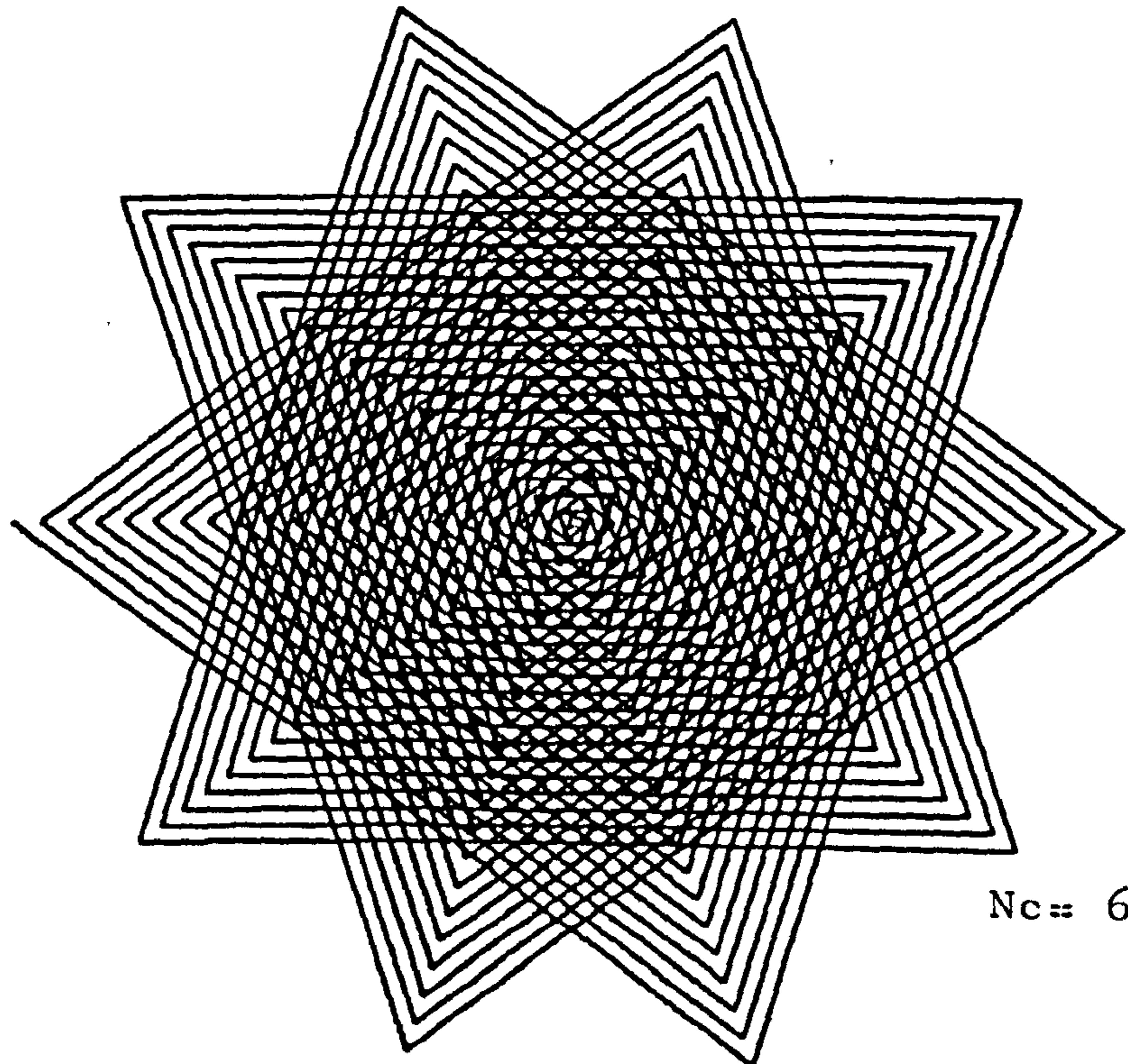

$N_c = 60$

Figure 6.1.2

## 6.2 EXAMPLE OF THE 3-D LIBRARY

This example illustrates how a wide-angle view could be made of a 20 by 20 grid of cubes. The stages of the program design are:

- 1) Initialise plotting.
- 2) Select an origin on the plotter paper.
- 3) Generate one cube.
- 4) Select a point of observation.
- 5) Draw a 3-D grid.
- 6) Terminate plotting.

The output shown in Figure 6.2.1 was produced by the following program:

```
DIMENSION C(98)
CALL START
CALL ORIGIN(5.0,5.0)
CALL CUBE(C,1.0)
CALL FISHI(5.0,5.0,-20.0,5.0,5.0,0.0,4.0)
CALL GRID3D(C,2.0,20,1.5,20,1.5,0.0,0.0,0.0,-1)
CALL FINISH(10.0)
STOP
END
```

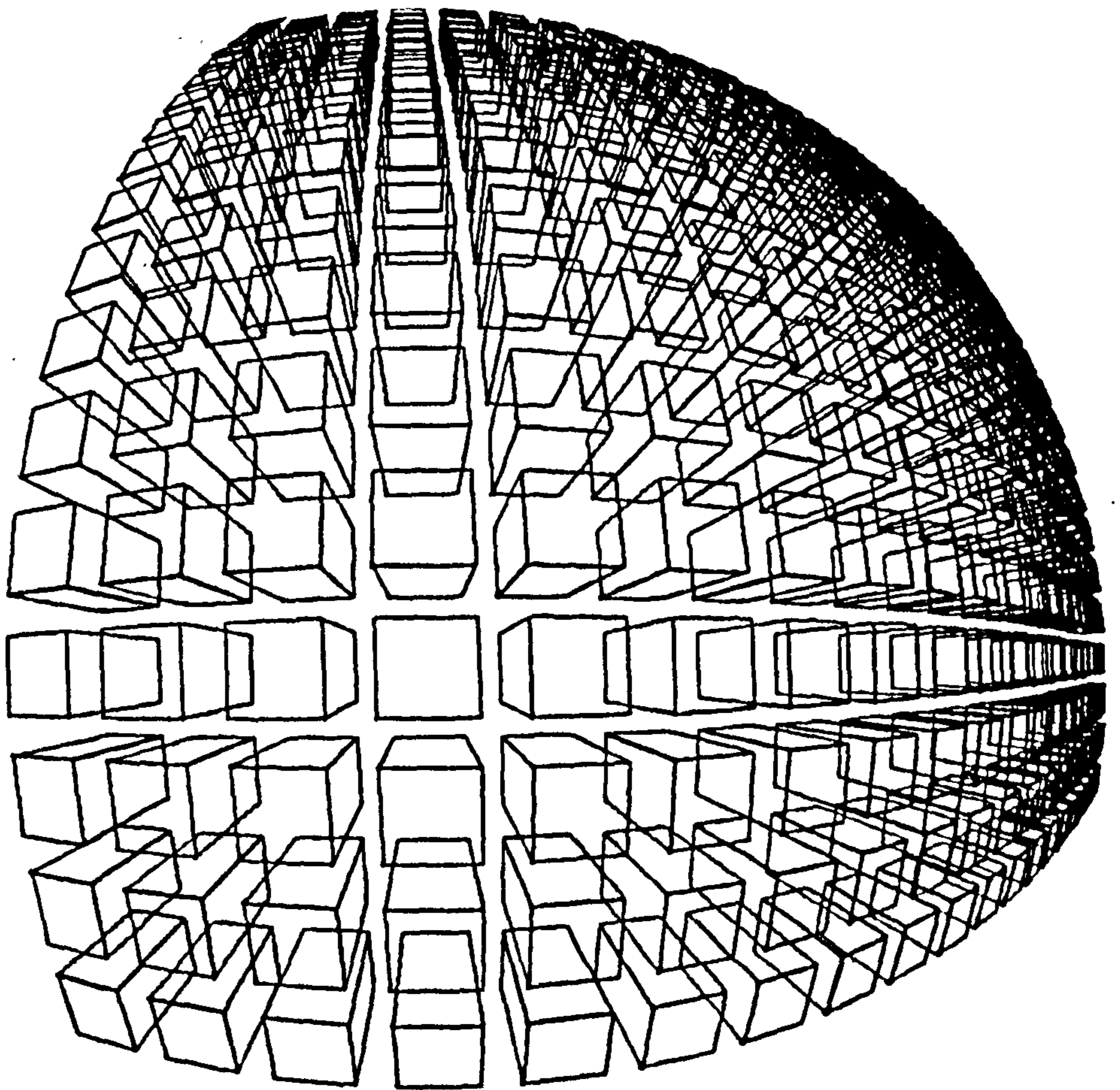

GRID3D & FISHI

Figure 6.2.1



### 6.3 EXAMPLE OF SHAPE MANIPULATION

An interesting manipulative command is PULL, which distorts shapes by pulling or compressing them in a specified direction.

This example draws out four views of a horse that is being compressed vertically. The program design stages are:

- 1) Initialise plotting.
- 2) Select an origin on the plotter paper.
- 3) Generate a horse.
- 4) Repeat four times.
  - 4.1) Pull horse
  - 4.2) Draw horse
  - 4.3) Change origin
- 5) Terminate plotting.

The output shown in Figure 6.3.1 was produced by the following program:

```

      DIMENSION H(237),P(237)
      CALL START
      CALL ORIGIN(5.0,2.0)
      CALL HORSE(H)
      DO 1 I=1,4
      CALL PULL(H,0.0,0.0,90.0,FLOAT(I)/4.0,P)
      CALL DRAW(P,1.0,0.0,0.0)
      CALL ORIGIN(0.0,1.0)
1  CONTINUE
      CALL FINISH(10.0)
      STOP
      END

```

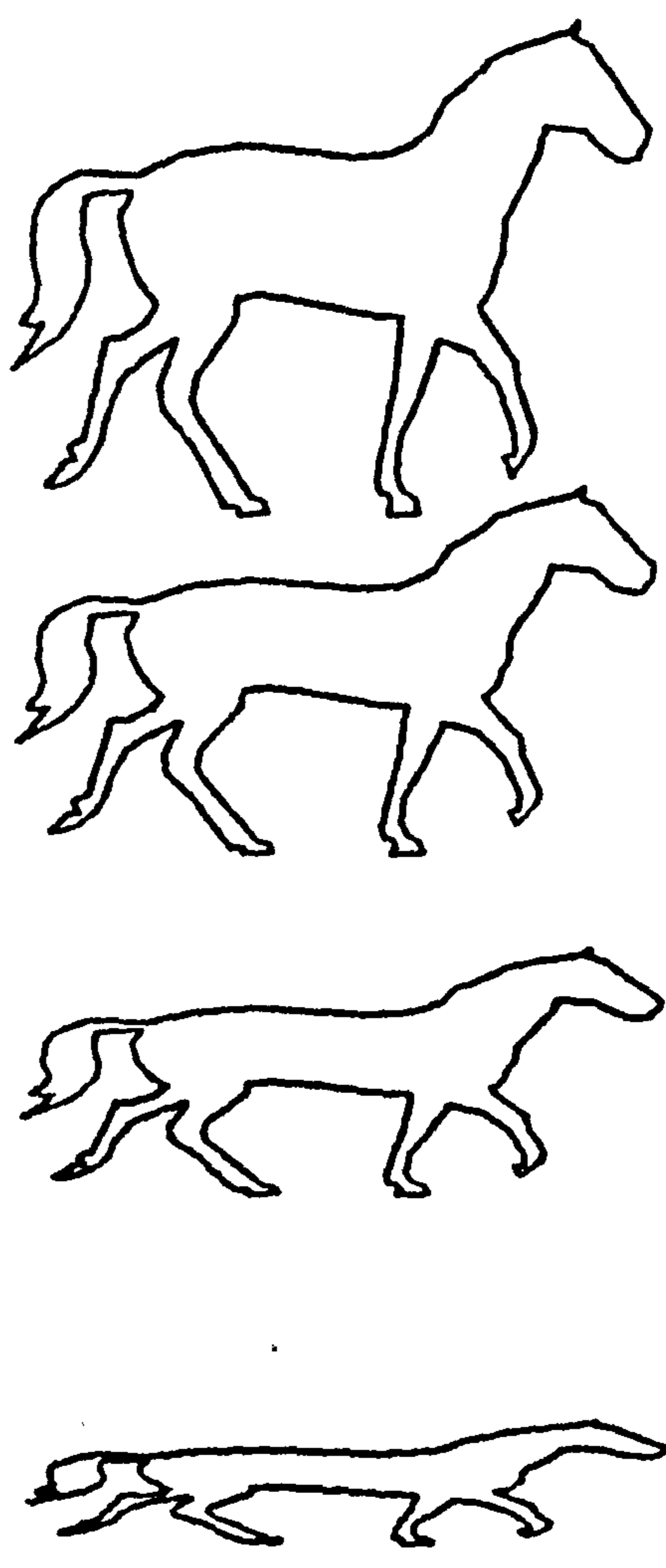

PULL

Figure 6.3.1

#### 6.4 EXAMPLE OF SURFACES

This example shows how shapes may be generated from others, and their eventual use in sweeping out a surface.

The requirements of this program are to create a surface of a waveform which consists of a linearly damped cosine wave.

The design stages of the program are:

- 1) Initialise plotting.
- 2) Select an origin on the plotting paper.
- 3) Generate a cosine wave.
- 4) Generate a line.
- 5) Create a damped cosine wave with ASMDSH.
- 6) Draw the surface with SURFAC.
- 7) Terminate plotting.

The surface in Figure 6.4.1 was produced by the following program:

```

DIMENSION A(203),B(7),W(200),OV(200),UN(200)
CALL START
CALL ORIGIN(5.0,5.0)
CALL SINE(A,1.0,4.0,90.0,1260.0,100,0.0,1.0)
CALL LINE(B,1.0,1.0,1.0,0.0,2)
CALL ASMDSH(A,1,B,1,A,3)
CALL SURFAC(A,6.0,200,6.0,50,30.0,3.0,3.0,
1          W,OV,UN,0.0,0.0)
CALL FINISH(10.0)
STOP
END

```

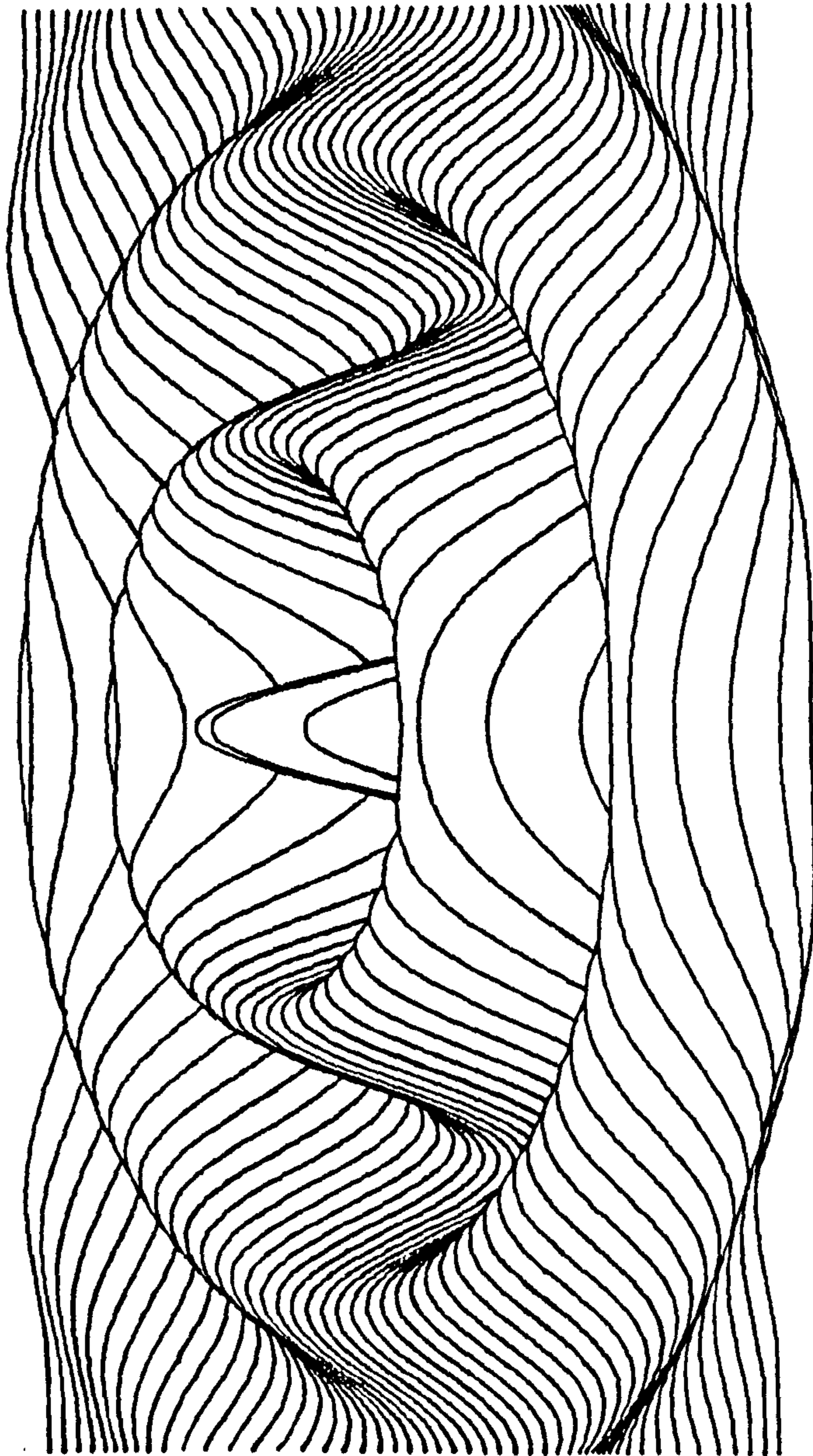

SURFAC

Figure 6.4.1

## 6.5 EXAMPLE OF SPECIAL EFFECTS

In this example, CONECT is used to join together vertices on a 20 pointed star.

The program design stages are:

- 1) Initialise plotting.
- 2) Select an origin on the plotter paper.
- 3) Generate a 20 pointed star.
- 4) Call CONECT.
- 5) Terminate plotting.

The following program produced the output shown in Figure 6.5.1.

```
DIMENSION A(50)
CALL START
CALL ORIGIN(5.0,5.0)
CALL STAR(A,20,2.0,0.5)
CALL CONECT(A,1.0,0.0,0.0)
CALL FINISH(10.0)
STOP
END
```

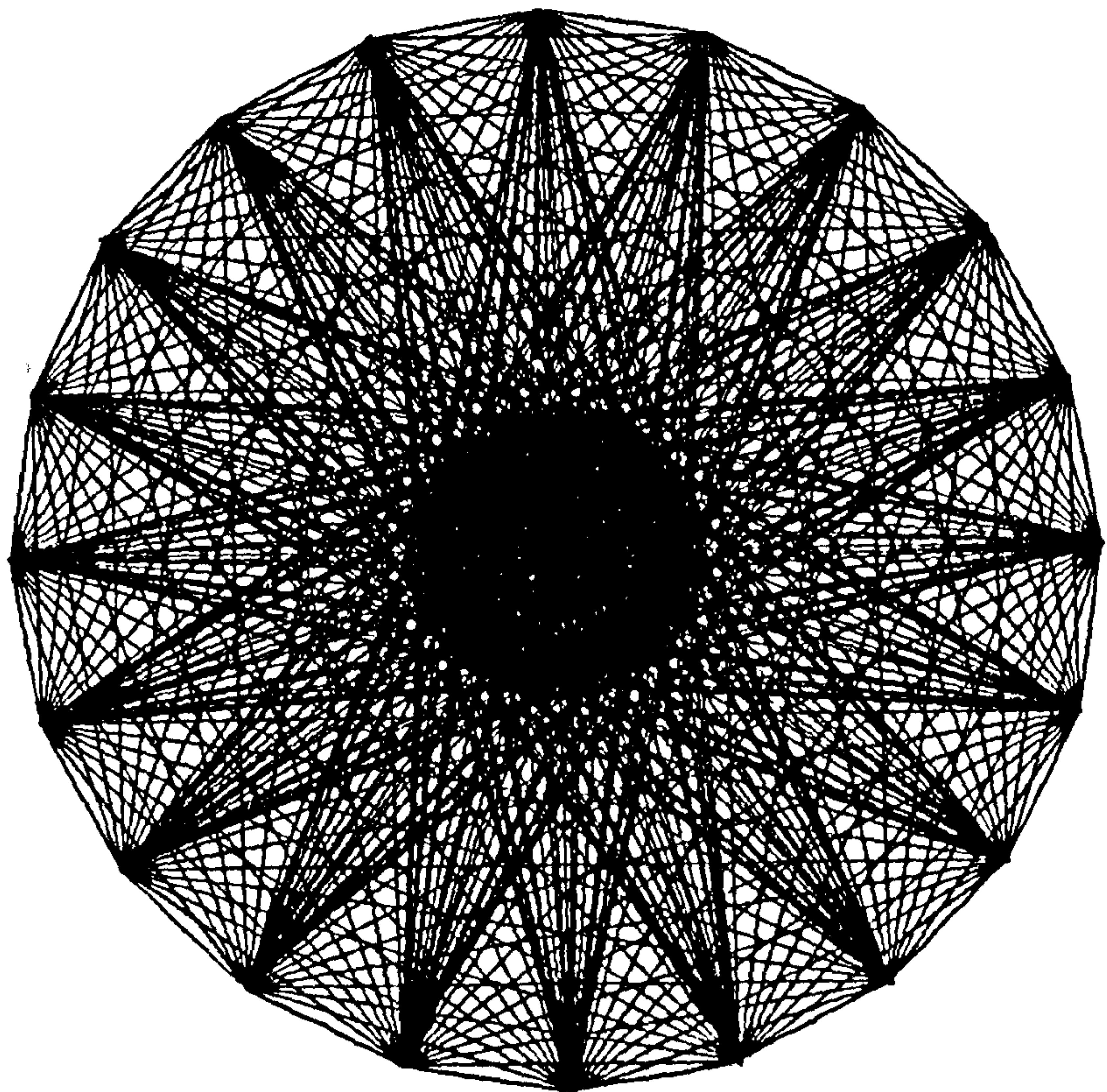

CONNECT

Figure 6.5.1

## 6.6 VARIOUS EXAMPLES

### EXAMPLE I

Reference to Figure 6.6.1 will show a 5 by 20 grid of cubes that have been 'cycled' 10 times. The secret of the solution is to identify that the complete drawing consists of two different rows of cubes interwoven together.

The first row has the cubes displaced by:

X=cube width

Y=0.0

Z=cube width

and the second row has the cubes offset by:

X=cube width

Y=1.0

Z=cube width

The program design stages are:

- 1) Initialise plotting.
- 2) Select an origin on the plotter paper.
- 3) Generate a cube.
- 4) Select an observation point.
- 5) Repeat the following 10 times:
  - 5.1) Repeat the following 10 times:
    - 5.1.1) Draw row of cubes.
    - 5.1.2) Draw row of offset cubes.
    - 5.1.3) Change offset variables.
  - 5.2) Cycle cube.
- 6) Terminate plotting.

The output illustrated in Figure 6.6.1 was produced by the following program:

```
DIMENSION C(98)
CALL START
CALL ORIGIN(0.0,1.0)
CALL CUBE(C,1.0)
CALL EYE(10.0,10.0,-20.0,0.0,0.0,0.0)
DO 1 I=1,10
Y=0.0
Z=0.0
DO 2 J=1,10
CALL ROW3D(C,1.0,5,1.0,0.0,1.0,0.0,Y,Z,-1)
CALL ROW3D(C,1.0,5,1.0,0.0,1.0,1.0,Y+1.0,
1          Z+1.0,-1)
Y=Y+2.0
Z=Z+1.0
2 CONTINUE
CALL CYCLE(C,1,0.1,C)
1 CONTINUE
CALL FINISH(10.0)
STOP
END
```

A similar drawing is shown in Figure 6.6.2, but the scene is seen through a wide-angle lens.



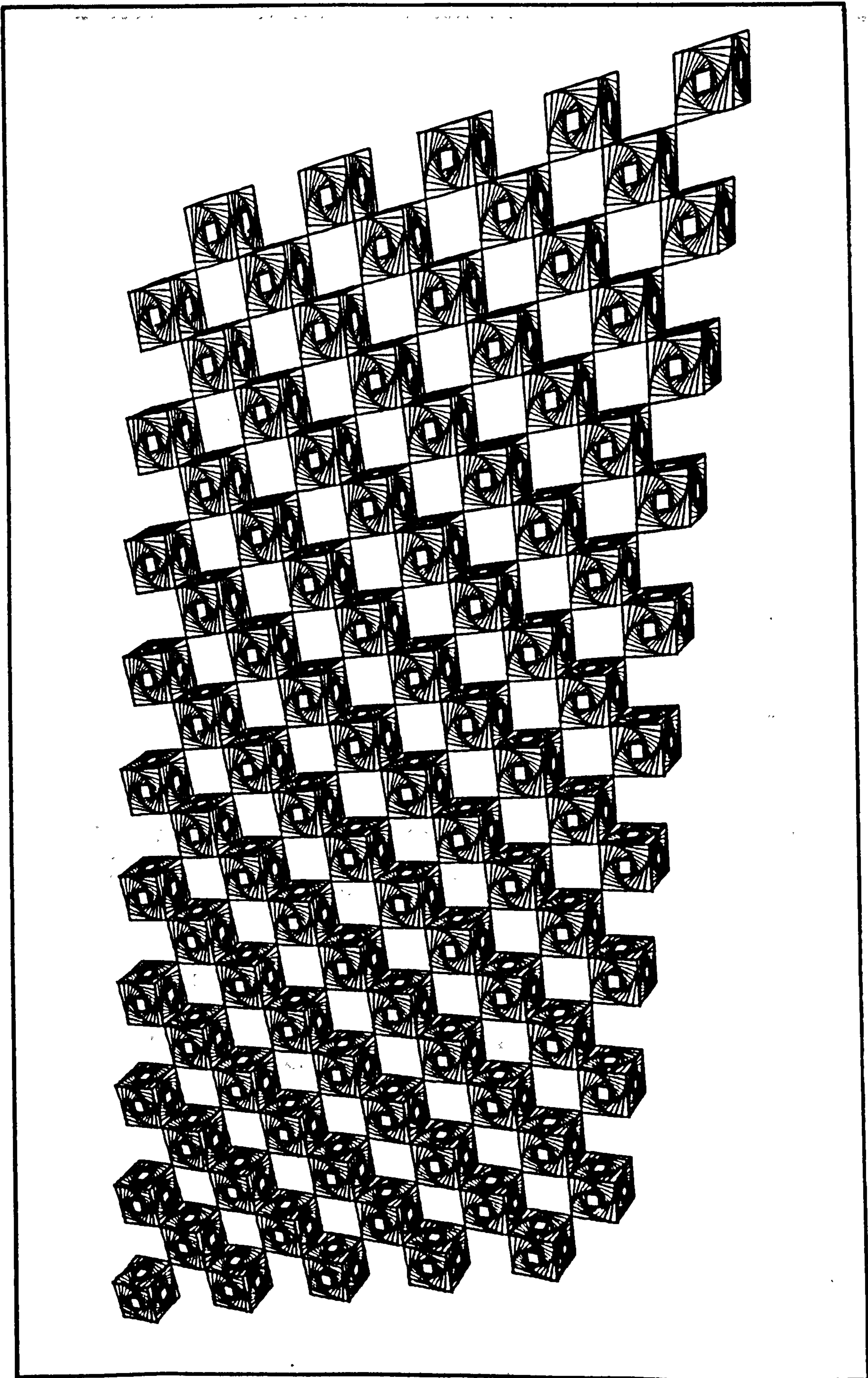

Figure 6.6.1

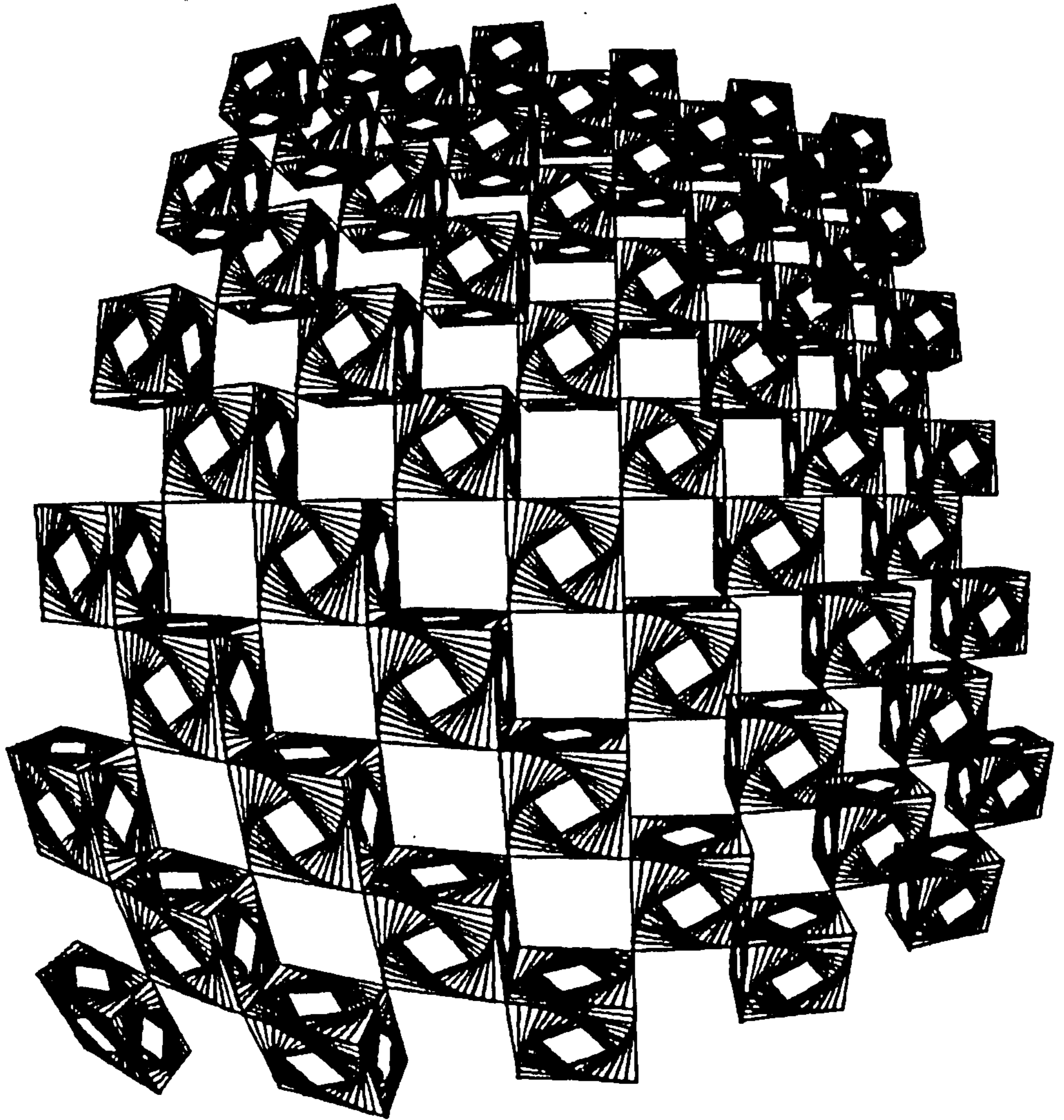

Figure 6.6.2

EXAMPLE II

The butterfly shown in Figure 6.6.3 was created by repeatedly tracing around the contour of a butterfly at distances increasing according to a square law.

The program design stages are:

- 1) Initialise plotting.
- 2) Select an origin on the plotter paper.
- 3) Generate a butterfly.
- 4) Repeat 20 times:
  - 4.1) Draw butterfly.
  - 4.2) Increase tracing distance.
- 5) Terminate plotting.

The following program produced the drawing shown in Figure 6.6.2.

```

DIMENSION B(209),C(209)
CALL START
CALL ORIGIN(5.0,5.0)
CALL BUTFLY(B)
DO 1 I=1,20
CALL TRACE(B,FLOAT((I-1)x(I-1))/400.0,C)
CALL DRAW(C,1.0,0.0,0.0)
1 CONTINUE
CALL FINISH(10.0)
STOP
END

```

A similar drawing shown in Figure 6.6.4 was produced by the same program with more tracing.

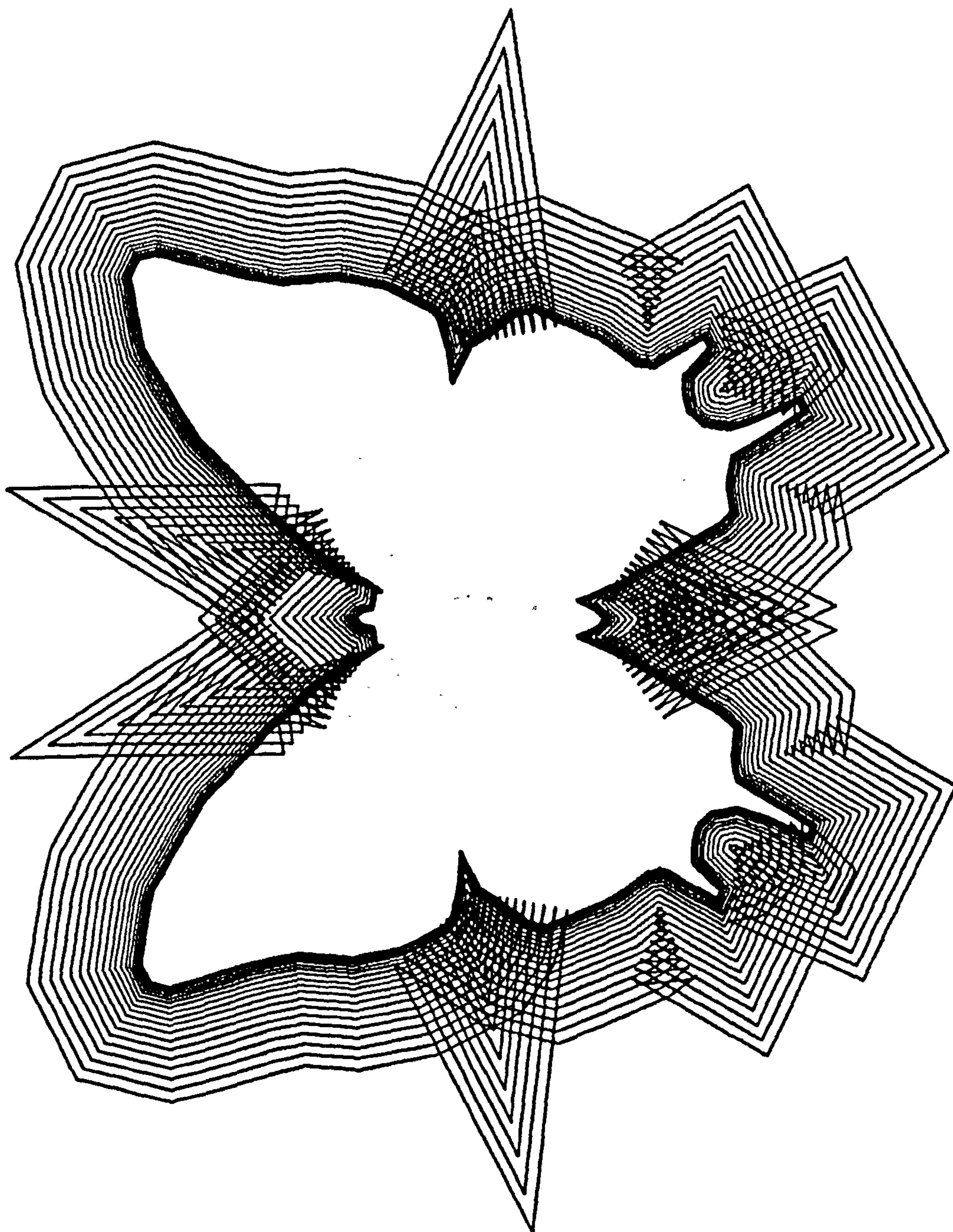

TRACE

Figure 6.6.3

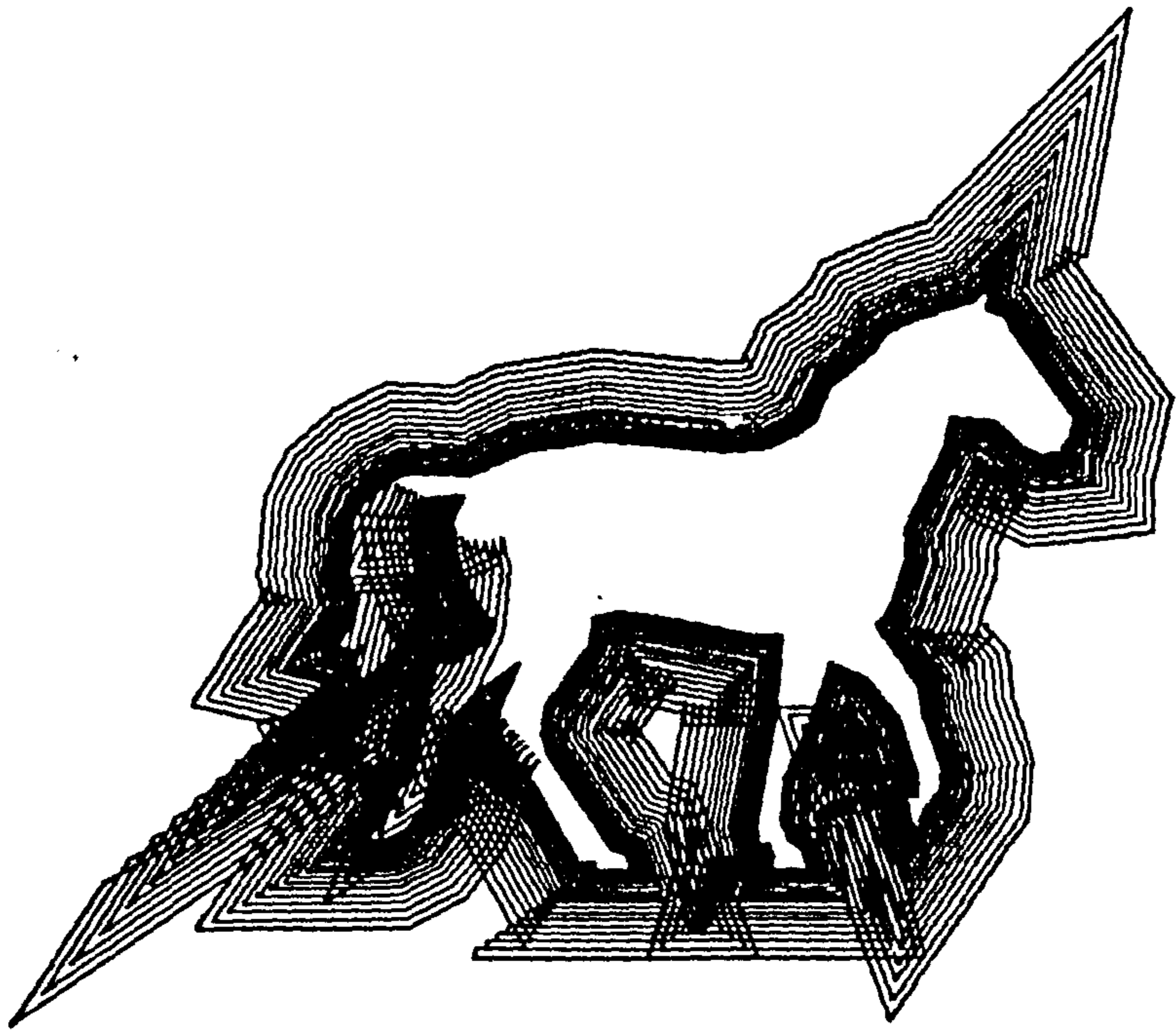

TRACE

Figure 6.6.4

## 7. APPLICATION AREAS FOR PICASO

The terms of reference for this project were to develop a computer graphics system, that could be easily used by people working in the areas of art and design. The result has been the graphics system PICASO.

Throughout the evolution of PICASO, the author has been aware of its potential as a general purpose graphics system. In fact it is difficult to specify a technical area that could not in some way use the system to some advantage. This section continues to examine three different application areas where PICASO is already having some influence.

## 7.1 ART & DESIGN

PICASO has been primarily designed to enable the artist/designer to use the graphic capabilities of the digital computer. The contents of the language has been formalised to anticipate the requirements of this type of user and the program examples in Section 6 illustrate the effectiveness and simplicity of the language.

The author has been teaching PICASO with a high degree of success to the following courses:

DipAD Fine Art (FT) Middlesex Polytechnic.

DipAD Graphic Design (FT) Middlesex Polytechnic

Computer Graphics in Middlesex Polytechnic.

Art & Design.

The system has also been implemented at the Slade School of Art on an IBM 360 system, and is being used by post-graduate students in Fine Art. It is also to be implemented at the Royal College of Art in the near future.

There are numerous application areas for computer graphics in art and design, some of them being:

- 1) Pattern generation,
- 2) Fabric design,
- 3) Animation,
- 4) Technical drawing aid for 2 and 3-D work,
- 5) Sculpture,
- 6) Cover design,

## 7) Fine art.

In all of these areas there is a place for computer graphics to assist the design process, not as a replacement for artistic creativity, but as a stimulus to explore and invent.



## 7.2 MATHEMATICS

Much of mathematics is concerned with the analysis of systems existing in space, and even when there is not a direct association with space, the spatial analogue can present a very realistic interpretation of the system.

As PICASO was developing, the author became aware of the potential of the system in teaching geometric concepts in mathematics. So often in mathematics, a concept is misunderstood because the student cannot visualise what is really happening in space; but with PICASO, the student has a means of simulating the mathematical model graphically. For example, there are two subroutines MATOP2 and MATOP3 which perform matrix multiplication upon two and three-dimensional structures. These allow the student to experiment and investigate directly, the relationships between matrices and the movement of objects in space.

The solution of equations is often taught from a graphical aspect, and PICASO has features that could be employed in this area.

Functions of the form:

$$\text{Constant} = f(x, y)$$

could be represented as a two-dimensional array and viewed as a three-dimensional surface. This type of picture reveals so much data that a truer insight is often gained by this approach.

Other areas of mathematics that could be affected include:

- 1) Function generation,
- 2) Rotations and reflections
- 3) Mappings,
- 4) Surfaces,
- 5) Vectors.

### 7.3 ENGINEERING

Engineering can cover so many different areas that it might be useful to mention just two application areas with which the author has been associated.

The first is in civil engineering. Students studying for the BSc in Civil Engineering at Middlesex Polytechnic are taught PICASO as a general purpose graphics language. It is used in a wide variety of ways, from the analysis of experimental data, to the realisation of three-dimensional views of bridges and buildings. As this type of student already has an understanding of FORTRAN, the teaching of PICASO is just a natural extension to the language, and presents no problem to the student.

The second application is in control engineering, where PICASO is being employed as a method of identifying conditions of stability in hypothetical non-linear control systems. The technique employed, is to interpret the stability equation as a three-dimensional surface, draw this with PICASO and then identify the topological characteristics that reflect the stability of the system.

It is believed that this combination of activities is unique in this field, and that it could develop into a general method of systems analysis. Students studying control systems at Middlesex Polytechnic are to be taught PICASO in order that they might use it in this mode of analysis.

## 8 CONCLUSIONS

Although PICASO has only been operational for a few months, it is already implemented in one University and three Polytechnics, with the prospect of being adopted by every Polytechnic in Great Britain. It is also to be made available to every interested educational institution.

This immediate response reflects the success of PICASO, for no matter how sophisticated a graphics language might be, unless it can provide quality drawings for the non-technical user, it has failed. The art-work supplied with this thesis illustrates the wide range of graphic effects that can be achieved with PICASO. They have been produced by the author, who is not an artist, not for any artistic end, but simply to express the effectiveness of PICASO in various graphic modes.

PICASO has already been taught by the author to many types of students working in art and design, engineering and mathematics to establish any weaknesses in the language. Although minor adjustments have been made, the underlying structure has withstood this exacting and final method of testing computer packages.

PICASO has for the first time enabled the author to successfully teach computer graphics to the non-numerate student. Previous attempts had failed

due to technical problems raised by students, such as:

"What is a radian?"

"What is the distance between these  
two points?"

"Do these lines intersect?"

"How can I shade this shape?"

"How can I test this point to see if  
it is inside this shape?"

These problems and many more, destroyed the normal teaching continuity, and eventually displaced the objective of the course to such a distance, that this goal was never achieved.

The teaching methodology with PICASO is completely different. A course begins with a brief talk about computers and how they can be made to draw. The student is then introduced to essential concepts of the language such as numbers, variables, space and then shown how to code. He is then given the PICASO User Manual shown in Section 11, and then taken through some simple example programs. After this introduction, he writes his first program and this is normally after one hours tuition. Subsequent programs require very little effort as they have a consistent format.

Some time can be spent on two-dimensional work, but

the student often wishes to explore three-dimensions and surfaces; this demands an explanation of the 3-D spatial conventions and the significance of the picture plane. The student then continues to use PICASO in various projects where he develops his ideas in greater depth.

PICASO is an extensible language and already includes many additions proposed by students on previous courses. The ease with which this can be performed is essential to the continued use of PICASO, and the author is determined that PICASO will continue to enjoy its early success by supporting the software until some independent scheme can be arranged to maintain it.

PICASO has been designed to be used. The author now hopes that it will be used to design.

9.1 APPENDIX I

Summary of PICASO system commands.

EYE	Establishes the position of the observer in the 3-D conceptual space.
FINISH	Terminates plotting.
FISHI	Establishes the position of a wide-angle observer in the 3-D conceptual space.
ORIGIN	Establishes a new origin on the 2-D projection space.
PLANE	Alters the distance between the picture plane and the observer.
START	Initializes plotting.
WINDOW	Creates a virtual window on the 2-D projection plane.

9.2 APPENDIX II

Summary of PICASO input/output commands.

ARRAY1	Reads from punched cards a REAL one-dimensional array.
ARRAY2	Reads from punched cards a REAL two-dimensional array.
ARRAY3	Reads from punched cards a REAL three-dimensional array.
IRRAY1	Reads from punched cards an INTEGER one-dimensional array.
IRRAY2	Reads from punched cards an INTEGER two-dimensional array.
IRRAY3	Reads from punched cards an INTEGER three-dimensional array.
LRRAY1	Reads from punched cards a LOGICAL one-dimensional array.
LRRAY2	Reads from punched cards a LOGICAL two-dimensional array.
LRRAY3	Reads from punched cards a LOGICAL three-dimensional array.
OBJECT	Reads from punched cards a PICASO 3-D object.
PRINT	Prints to a line-printer a PICASO structure.
PUNCH	Punches onto punched cards a PICASO structure.
SHAPE	Reads from punched cards a PICASO 2-D shape.



9.3 APPENDIX III

Summary of PICASO shapes.

AGNESI	Fermat's 'Witch of Agnesi' curve.
ARC	Circular arc.
ASPIRA	Archimedean spiral.
ASTROI	Astroid.
BUTFLY	Butterfly.
CARDI	Cardioid.
CUBPAR	Cubic parabola.
DLINE	Dashed line.
DELTOI	Deltoid.
DOT	Dot.
ELLIPS	Ellipse.
EPITRO	Epitrochoid.
FACE	Human face.
GRILL	Regular grill of lines.
HORSE	Horse.
HYPERB	Hyperbola.
HYPOTR	Hypotrochoid.
LEFANT	Elephant.
LINE	Line.
LISSAJ	Lissajous figure.
LSPIRA	Logarithmic spiral.
PARAB	Parbola.
POLYGN	Regular polygon.
RECTNG	Rectangle.
RHINO	Rhinosceros.

APPENDIX III Continued.

RHODON	Rhodon.
SHARK	Shark.
SINE	Sinusoid.
SQUARE	Square.
STAR	Regular star.

9.4 APPENDIX IV

## Summary of PICASO objects.

BOX	Box.
CONE	Cone.
CYLIND	Cylinder.
DOT3D	Dot.
GRIL3D	Regular grill of lines.
LINE3D	Line.
SPHERE	Sphere.

9.5 APPENDIX V

Summary of PICASO structure manipulating commands.

- ASMDSH Adds, subtracts, multiplies and divides two PICASO STRUCTURES.
- COPYSH Makes a copy of a PICASO structure.
- CYCLE Moves vertices along lines to their nearest neighbour.
- EXTSH Extracts a contour or surface from a PICASO structure.
- FIT Adjusts a 2-D PICASO contour to fit between two points.
- FORM3D Creates a 3-D PICASO surface from a 2-D shape moulded to some contour.
- JOIN Augments a PICASO structure by another.
- MATOP2 Performs a 2 by 2 matrix multiplication on a PICASO shape.
- MATOP3 Performs a 3 by 3 matrix multiplication on a PICASO object.
- MIRROR Produces a mirror image of a PICASO shape.
- MIX2D Exchanges X and Y coordinates in a PICASO shape.
- MIX3D Exchanges X, Y and Z coordinates in a PICASO object.
- NORMAL Adjusts a vertex to a specific position and makes corresponding adjustments to the rest for a PICASO shape.
- NORM3D Adjusts a vertex to a position and makes corresponding adjustments to the rest for PICASO object.

9.5 APPENDIX V Continued.

PERSHP	Generates a PICASO shape from a perspective view of a PICASO object.
PULL	Distorts a PICASO shape in a specified direction.
REMOVE	Removes a contour or surface from a PICASO STRUCTURE.
REVERS	Reverses the vertex sequence in a PICASO structure.
RIPPLE	Alters the starting vertex for a PICASO CONTOUR OR SURFACE.
ROTATE	Rotates a PICASO shape about a fixed point.
SHIFT	Shifts a PICASO shape in a given direction.
SHIFT3	Shifts a PICASO object in a given direction.
SIZE	Alters the size of a PICASO shape.
SIZE3	Alters the size of a PICASO object.
STICK	Sticks two open PICASO contours together.
THICK	Creates a 3-D extrusion of a PICASO shape.
THIN	Creates a 2-D projection of a PICASO object.
TRACE	Traces around a PICASO shape.
TRANSH	Transforms one PICASO structure into another.
TRANSP	Transposes a PICASO shape into a 3-D PICASO SURFACE.
TURN3D	Rotates a PICASO object about an axis.
WARP2D	Subjects a PICASO shape to new laws of space
WARP3D	Subjects a PICASO object to new laws of space.

9.6 APPENDIX VI

Summary of PICASO plotting commands.

DRAW	Draws out a PICASO shape.
DRAW2D	Draws out a PICASO shape in perspective.
DRAW3D	Draws out a PICASO object.
DSHAPE	Draws out a dashed PICASO shape.
DSLNE	Draws out a dashed line.
FILL	Draws out a tessellation of PICASO shapes.
FILL2D	Draws out a tessellation of PICASO shapes in perspective.
FILL3D	Draws out a tessellation of PICASO objects.
GRID	Draws out a regular grid of PICASO shapes.
GRID2D	DRAWS out a regular grid of PICASO shapes in perspective.
GRID3D	Draws out a regular grid of PICASO objects.
HATCH	Hatches in a PICASO shape with parallel lines.
MASK	Draws out a PICASO shape masked by another.
ROW	Draws out a row of PICASO shapes.
ROW2D	Draws out a row of PICASO shapes in perspective.
ROW3D	Draws out a row of PICASO objects.
PLIT	Moves the plotter pen to a new position.
SMOOTH	Draws out a PICASO shape with its vertices connected by a cubic spline curve.
STIPLE	Draws a specified number of random dots inside a PICASO shape.

9.7 APPENDIX VII

Summary of PICASO structure analysis commands.

- CLOCK      Determines whether a PICASO contour is clockwise or counter-clockwise.
- CLOK3D     Determines whether a PICASO surface is clockwise or counter-clockwise.
- CLOSE      Closes a PICASO contour.
- CLOSED     Determines whether a PICASO contour or surface is closed or open.
- CROSS      Determines whether two lines intersect and the nature of the intersection.
- HULL       Determines the rectangular hull of a PICASO shape.
- INSIDE     Determines whether a given point is in or outside a PICASO shape.
- NDIMEN     Determines the core requirement of a PICASO structure.
- NLINES     Determines the number of contours or surfaces in a PICASO structure.
- NPOINT     Determines the number of vertices in a PICASO contour or surface.
- NSUB       Determines the data structure position for the start of a PICASO contour or surface.
- NXSUB      Determines the data structure position for the X-coordinate of a given vertex.
- NYSUB      Determines the data structure position for the Y-coordinate of a given structure.

9.7 APPENDIX VII Continued.

NZSUB      Determines the data structure position  
            for the Z-coordinate of a given vertex.

SENSE      Determines the spatial relationship  
            between a point and a line.

SLOPE      Determines the slope of a line joining  
            two vertices in a PICASO shape.



9.8 APPENDIX VIII

Summary of PICASO functions.

ITAKE	Generates a ranom INTEGER number between two boundaries.
PERSP	Calculates the picture plane position of a point in 3-D space.
TAKE	Generates a random REAL number between two boundaries.
XARC	Returns the X-coordinate of a point on a circular arc.
XCOORD	Returns the X-coordinate of a given vertex.
XELLIP	Returns the X-coordinate of a point on an ellipse.
XEPIT	Returns the X-coordinate of a point on an epitrochoid.
XHYPER	Returns the X-coordinate of a point on a hyperbola.
XHYPOT	Returns the X-coordinate of a point on a hypotrochoid.
XLISS	Returns the X-coordinate of a point on a Lissajous figure.
XLSPIR	Returns the X-coordinate of a point on a logarithmic spiral.
XMIRRO	Returns the X-coordinate of the reflection of a point.
XPARAB	Returns the X-coordinate of a point on a parabola.

9.8 APPENDIX VIII Continued.

XPERSP	Returns the X-coordinate of the picture plane position of a point in 3-D space.
XPOLY	Returns the X-coordinate of a point on a regular polygon.
XROT	Returns the X-coordinate of a point rotated about a given fixed point.
XSIN	returns the X-coordinate of a point on a sinusoid.
XYVLIN	Returns the X, Y or Z-coordinate of a point on a line.
YARC	Returns the Y-coordinate of a point on a circular arc.
YCOORD	Returns the Y-coordinate of a given vertex.
YELLIP	Returns the Y-coordinate of a point on an ellipse.
YEPIT	Returns the Y-coordinate of a point on an epitrochoid.
YHYPER	Returns the Y-coordinate of a point on a hyperbola.
YHYPOT	Returns the Y-coordinate of a point on a hypotrochoid.
YLISS	Returns the Y-coordinate of a point on a Lissajous figure.
YLSPIR	Returns the Y-coordinate of a point on a logarithmic spiral.
YMIRRO	Returns the Y-coordinate of the point reflected about a line.

9.8 APPENDIX VIII Continued.

- YPARAB Returns the Y-coordinate of a point on a parabola.
- YPERSP Returns the Y-coordinate of the picture plane position of a point in 3-D space.
- YPOLY Returns the Y-coordinate of a point on a regular polygon.
- YROT Returns the Y-coordinate of a point rotated about a given fixed point.
- YSIN Returns the Y-coordinate of a point on a sinusoid.
- ZCOORD Returns the Z-coordinate of a given vertex.

9.9 APPENDIX IX

Summary of special effects.

- CONNECT      Connects every vertex on a PICASO shape to every other vertex, with lines.
- CONEC3      Connects every vertex on a PICASO object to every other vertex with lines.
- GROW         Draws a PICASO shape located at every vertex of itself to any depth.
- GROW2D      Draws a PICASO shape located at every vertex of itself to any depth, in perspective.
- GROW3D      Draws a PICASO object located at every vertex of itself to any depth.
- MODSH       Modulates the boundary of a PICASO shape by an open PICASO contour.
- SNOW        Transforms a PICASO shape into a crystalline form to any depth.

9.10 APPENDIX X

Summary of array handling commands.

- FIND1 Searches a one-dimensional REAL array for the occurrence of a value.
- FIND2 Searches a two-dimensional REAL array for the occurrence of a value.
- FIND3 Searches a three-dimensional REAL array for the occurrence of a value.
- GET1 Returns a value from a one-dimensional REAL array.
- GET2 Returns a value from a two-dimensional REAL array.
- GET3 Returns a value from a three-dimensional REAL array.
- IFIND1 Searches a one-dimensional INTEGER array for the occurrence of a value.
- IFIND2 Searches a two-dimensional INTEGER array for the occurrence of a value.
- IFIND3 Searches a three-dimensional INTEGER array for the occurrence of a value.
- IGET1 Returns a value from a one-dimensional INTEGER array.
- IGET2 Returns a value from a two-dimensional INTEGER array.
- IGET3 Returns a value from a three-dimensional INTEGER array.
- IPUT1 Assigns a value to a one-dimensional INTEGER array.

9.10 APPENDIX X Continued.

IPUT2	Assigns a value to a two-dimensional INTEGER array.
IPUT3	Assigns a value to a three-dimensional INTEGER array.
LPUT1	Assigns a value to a one-dimensional LOGICAL array.
LPUT2	Assigns a value to a twodimensional LOGICAL array.
LPUT3	Assigns a value to a three-dimensional LOGICAL array.
PUT1	Assigns a value to a one-dimensional REAL array.
PUT2	Assigns a value to a two-dimensional REAL array.
PUT3	Assigns a value to a three-dimensional REAL array.

9.11 APPENDIX XI

Summary of PICASO surface commands.

- HIDE        Draws out a contour masked by the previous drawn contour.
- ISOMET     Produces an isometric projection of a surface generated by a rotated PICASO contour.
- MAP2D      Produces a 2-D contour map of vertical data stored in an array.
- MAP3D      Produces a 3-D contour map of vertical data stored in an array.
- SILUET     Produces a 3-D surface by spinning a PICASO contour.
- SURFAC     Produces a front-elevation view of a surface generated by rotating a PICASO contour.
- SURF3D     Realises a mesh type perspective surface from an array containing vertical data.

9.12 APPENDIX XII

PICASO Data structure

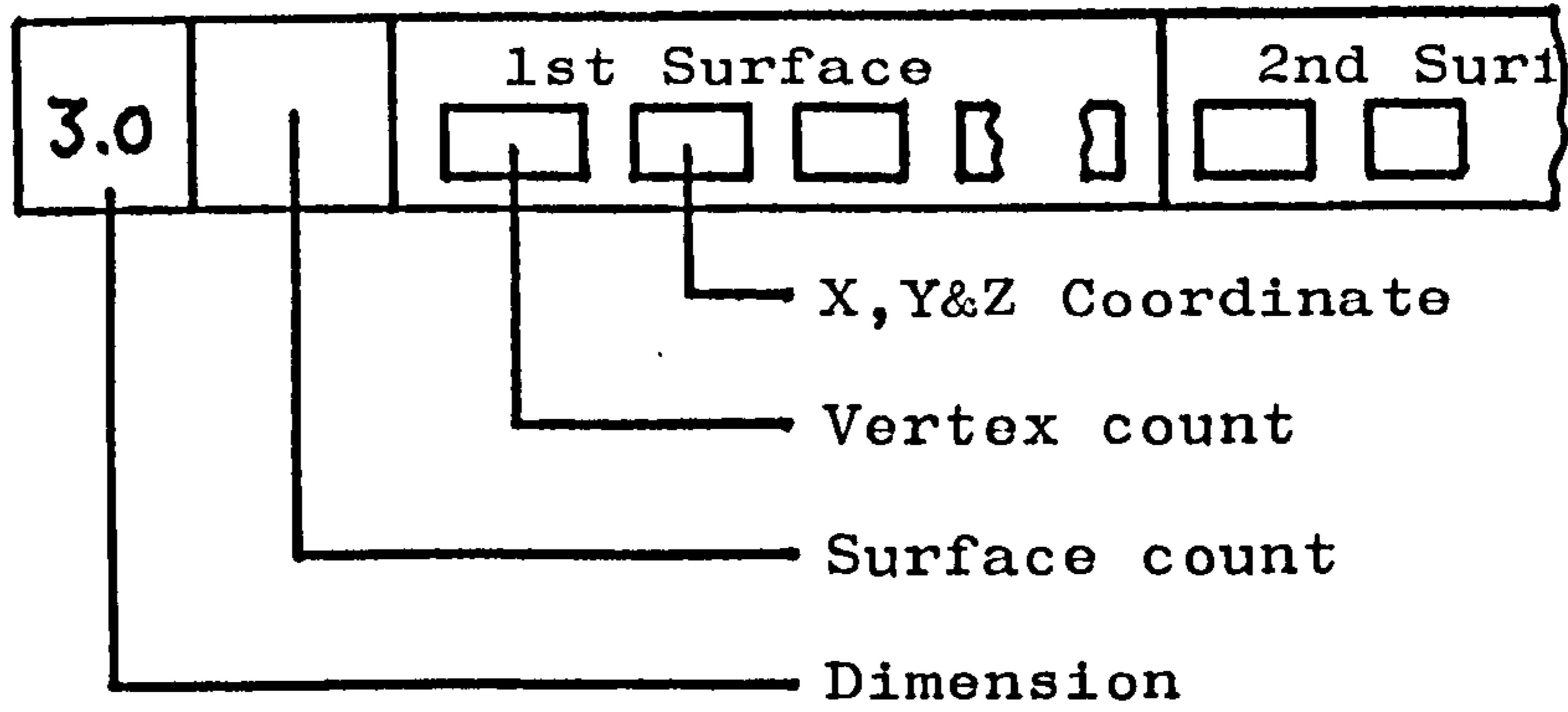
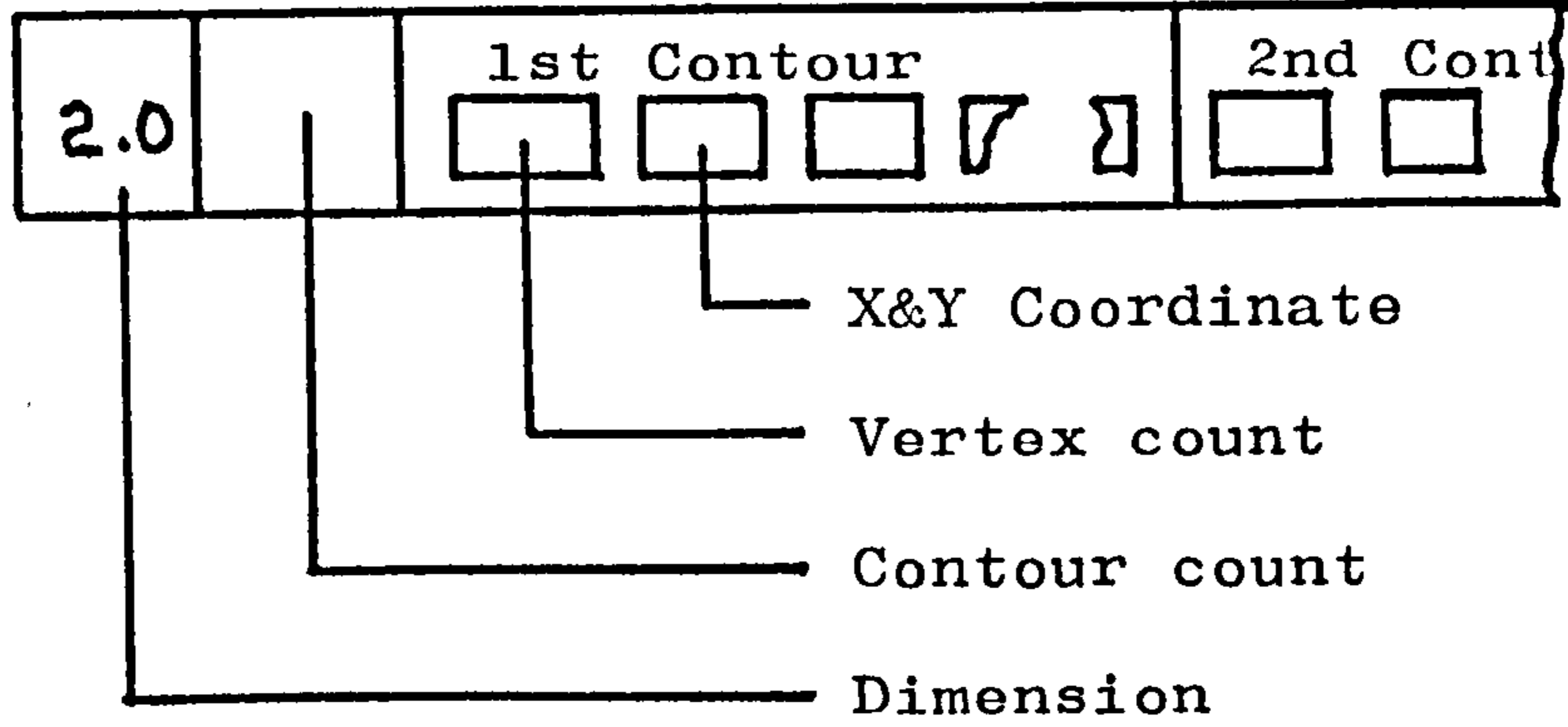



### 9.13 APPENDIX XIII

Windowing algorithm.

The function SENSE determines whether a point is to the left, coincident or to the right of a given line segment. Using this function it is possible to detect if two lines intersect and the nature of the intersection.

As PICASO uses a convention that clockwise contours create transparent windows and counter-clockwise opaque, the function CROSS can return the mode of intersection when a line segment is tested against the windowing shape. A line intersecting a clockwise contour is -ve, and a counter-clockwise is +ve. Thus when all the intersections have been detected, they are sorted using a binary tree sort, and the plotter pen lowered for each -ve intersection and raised for each +ve value as the line is drawn.

Figure 9.13.1 illustrates a complex window and the intersections a line segment makes.

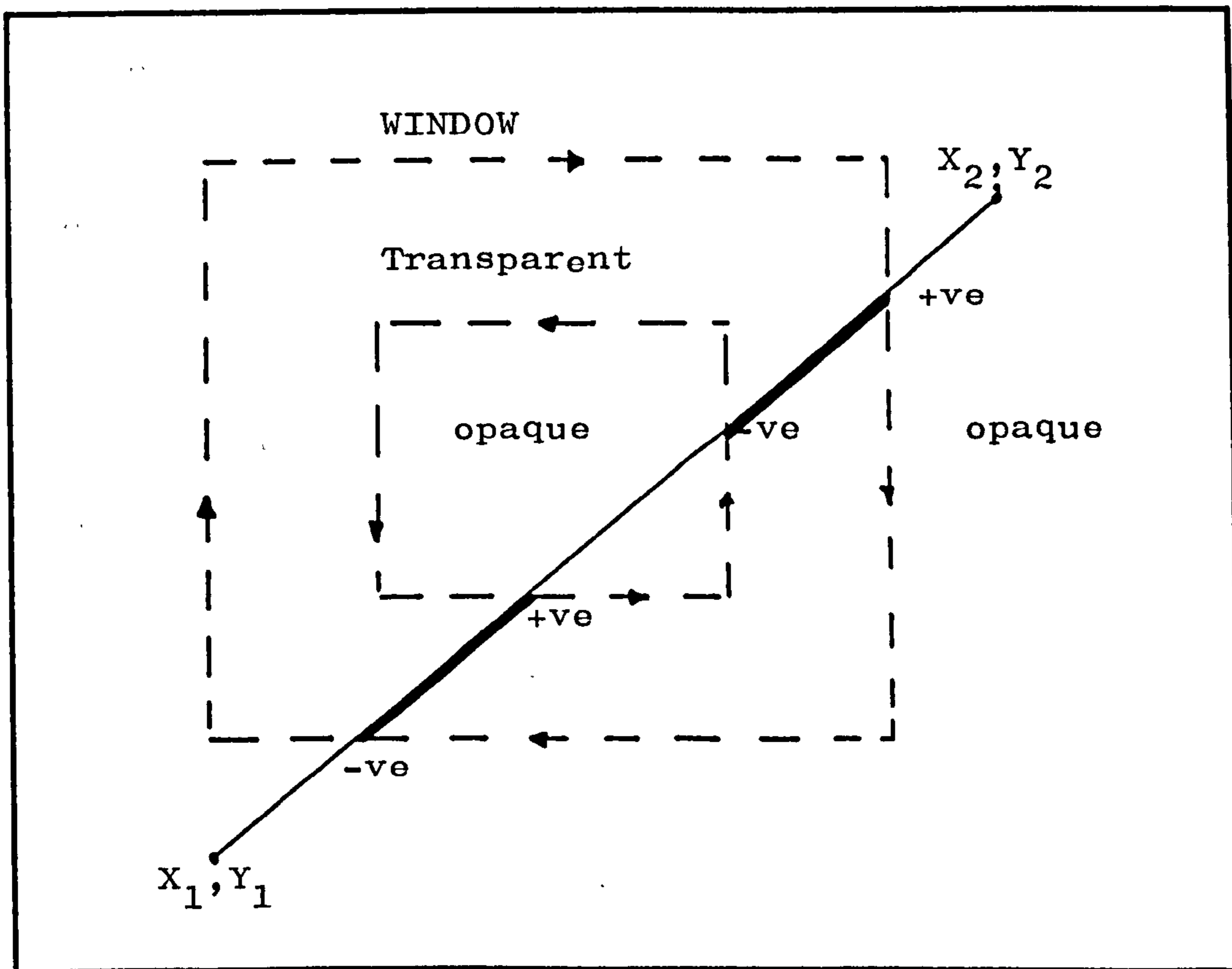
9.13 APPENDIX XIII Continued.Figure 9.13.1

9.14 APPENDIX XIV

## ISOMET Algorithm.

The conventional procedure of using two vectors is employed to maintain the current upper and lower horizons, but a space domain technique achieves hidden-line removal.

The picture plane is divided into the six domains shown in Figure 9.14.1, and they are defined as follows:

- 1) the domain above the upper-horizon
- 2) the domain below the lower-horizon
- 3) the domain between the two horizons
- 4) the domain where the two horizons meet
- 5) the domain on the upper-horizon
- 6) the domain on the lower-horizon.

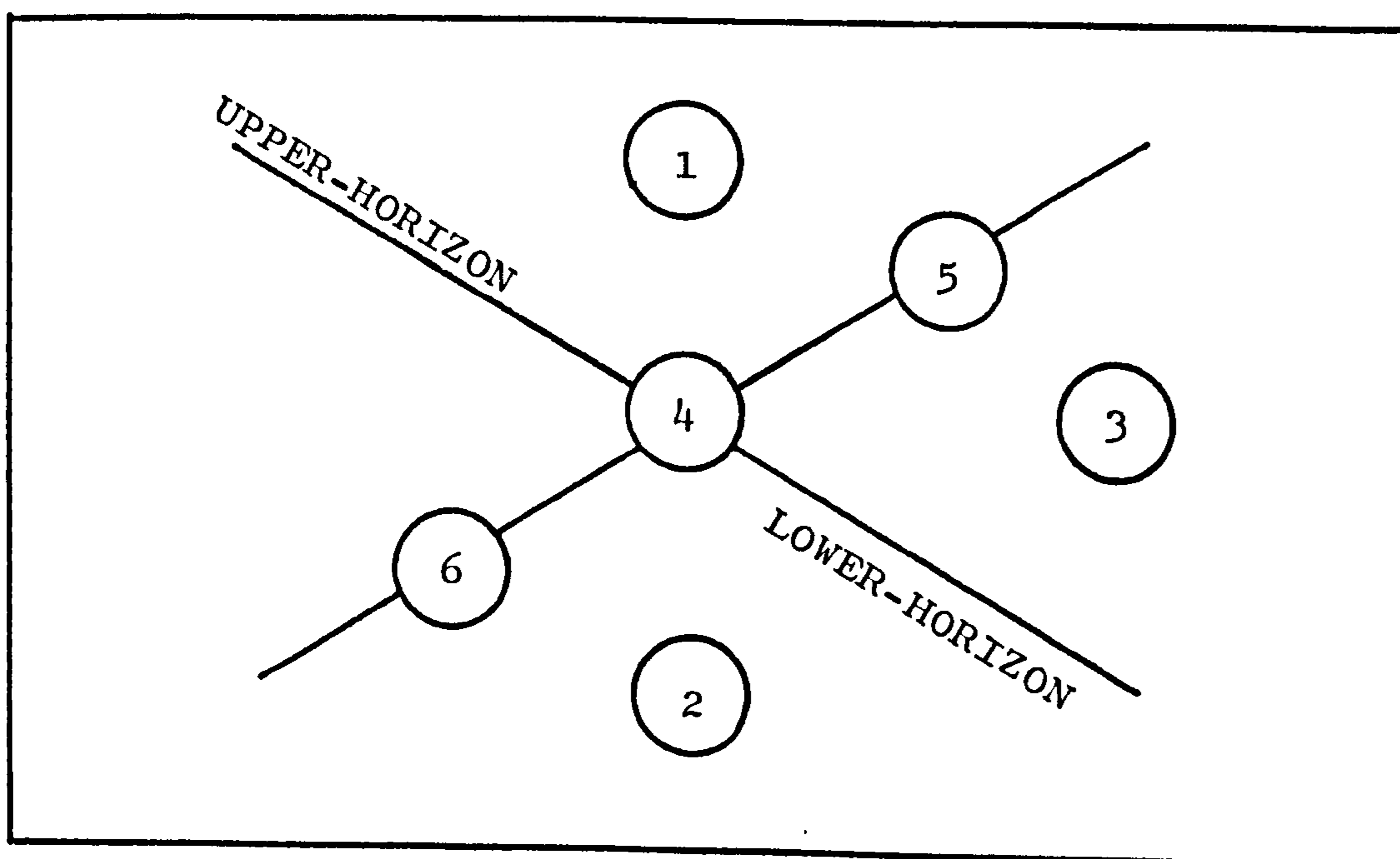

Figure 9.14.1

9.14 APPENDIX XIV Continued

Any line-segment to be drawn must either stay in one domain or cross to another, therefore a state table can describe the action to take under any condition. For example, a move from domain one to two requires the following actions:

- a) calculate the intersection with the upper-horizon and draw this line segment,
- b) calculate the intersection with the lower-horizon and ignore this segment,
- c) draw the remaining line segment and update the lower horizon.

To ensure that the surface is completely opaque, it is created and drawn in small rectangular tiles as shown in Figure 5.9.3.

10 REFERENCES

- 1 Reichardt, J.  
The Computer in Art, Page 8  
Studio Vista,  
London
- 2 Association of Computer Units in Colleges  
of Higher Education,  
CHESS Working Party,  
North Staffs. Polytechnic,  
Blackheath Lane,  
Stafford
- 3 Thomas, R.E.  
SPROGGS Manual (1974)  
Atlas Computer Laboratory,  
Didcot,  
Berkshire OX11 0QY
- 4 George, J.E.  
GEMS A Graphical Meta System  
Department of Computer Science,  
Colorado State University,  
Colorado, USA
- 5 Bork, A.M.  
APL for the SIGMA  
XEROX User Group Proceedings (Dec 7 8 1972)  
XEROX  
London
- 6 Armit, A.P.  
MULTIPATCH, A Language for interactive Design  
Computer Aided Design Autumn 1971 Page 10
- 7 Narasimham, R. & Reddy, V.S.N.  
Some Experiments in Scene Generation using COMPAX  
Tata Institute of Fundamental Research,  
IFIP Working Conference on Graphical Languages,  
North-Holland Press
- 8 Licklider, J.C.R.  
A Picture is worth a thousand Words... and it costs.  
SJCC 1969  
AFIPS Press,  
Montvale,  
New-Jersey, 617
- 9 DISSPLA (Display Integrated Software System and  
Plotting Language)  
Integrated Software Systems Corporation,  
San Diego,  
California, USA

- 10 Roberts, L.G.  
Machine Perception of Three Dimensional Solids  
Technical Report 315 (may 1963)  
MIT Lincoln Laboratory,  
Cambridge, USA
- 11 Warnock, J.E.  
A Hidden Surface Algorithm for Computer  
Generated Half-tone Pictures  
Technical Report 4-15 (1969)  
Computer Science Department,  
University of Utah,  
Salt Lake City, USA
- 12 Loutrel, P.P.  
A Solution to the Hidden line Problem for  
Computer Drawn Polyhedra,  
IEEE Transactions on Computers,  
Vol C-19 No 3 March 1970 Page 205
- 13 Matsushita, Y.  
Hidden line Elimination from a rotating object,  
CACM Vol 15 No 4 Page 245 April 1972
- 14 Knowlton, K.  
Graphic Languages,  
Proceedings of the Working Conference on  
Graphic Languages (1972)  
North-Holland Press
- 15 Knowlton, K. & Schwartz  
Films "PIXILLATIONS & UFO'S" (1970 1971)  
University of California,  
Department of Computer Science,  
Santa-Cruz, USA
- 16 Bush, D.J. & Bell, M.  
SPLINT, ACubic Spline Package (1974)  
Middlesex Polytechnic,  
Computer Centre,  
Queensway,  
Enfield,  
Middlesex
- 17 Csurí, C.  
The Computer in Art, Page 40  
Jasia Reichardt,  
Studio Vista,  
London

11 PICASO USER MANUAL

EYE

FINISH

FISHI

ORIGIN

START

WINDOW

FACTOR



DRAW  
DRAW2D  
DRAW3D  
DSHAPE  
DSHLNE  
FILL  
FILL2D  
GRID  
GRID2D  
HATCH  
HIDE  
ISOMET  
MASK  
PLIT  
ROW  
ROW2D  
SHADE  
SILUET  
SMOOTH  
STIPLE  
SURFAC

AGNESI  
ARC  
ASPIRA  
ASTROI  
CARDI  
CUBPAR  
DELTOI  
DOT  
ELLIPS  
EPITRO  
GRILL  
HYPERB  
HYPOTR  
LINE  
LINE<sup>3D</sup>  
LISSAJ  
LSPIRA  
PARAB  
POLYGN  
RECTNG  
RHODON  
SINE  
SQUARE  
STAR

BOX  
CUBE  
PYRAM

COPYSH  
EXPLOD  
EXTSH  
FIT  
FORM3D  
JOIN  
MIRROR  
MIX2D  
MIX3D  
NORMAL  
PERSHP  
PULL  
REMOVE  
REVERS  
RIPPLE  
ROTATE  
SHIFT  
SHIFT3  
SIZE  
STICK  
TRACE  
TRANSH  
TRANSP  
TURN3D

CLOCK  
CLOK3D  
CLOSED  
CROSS  
HULL  
INSIDE  
NDIMEN  
NLINES  
NPOINT  
NSUB  
NXSUB  
NYSUB  
NZSUB  
SENSE  
SLOPE

ITAKE  
PERSP  
POSCON  
TAKE  
XARC  
XCOORD  
XELLIP  
XEPIT  
XHYPER  
XHYPOT  
XLISS  
XLSPIR  
XMIRRO  
XPARAB  
XPERSP  
XPOLY  
XROT  
XSIN  
XYZLIN  
YARC  
YCOORD  
YEPIT  
YELLIP  
YHYPER  
YHYPOT  
YLISS  
YLSPIR  
YMIRRO  
YPARAB  
YPERSPS  
YPOLY  
YROT  
YSIN  
ZCOORD

CONECT  
CYCLE  
GROW  
GROW2D  
MODSH  
SNOW

NAME           AGNESI (Witch of Agnesi)

FUNCTION       Stores Fermat's Witch of Agnesi curve in an array

ARGUMENTS     (*ARRAY, XSPAN, YSPAN, N*)

*ARRAY*       (Real array) stores the 2-d *Picasso* Agnesi curve

*XSPAN*       (Real inches) is the width of the curve

*YSPAN*       (Real inches) is the height of the curve

*N*           (Integer) is the number of steps in the curve

EXAMPLE       *CALL AGNESI(A, 5.0, 5.0, 20)*

This statement stores in *A* the Witch of Agnesi curve 5.0 inches wide and 5.0 inches high, in 20 steps

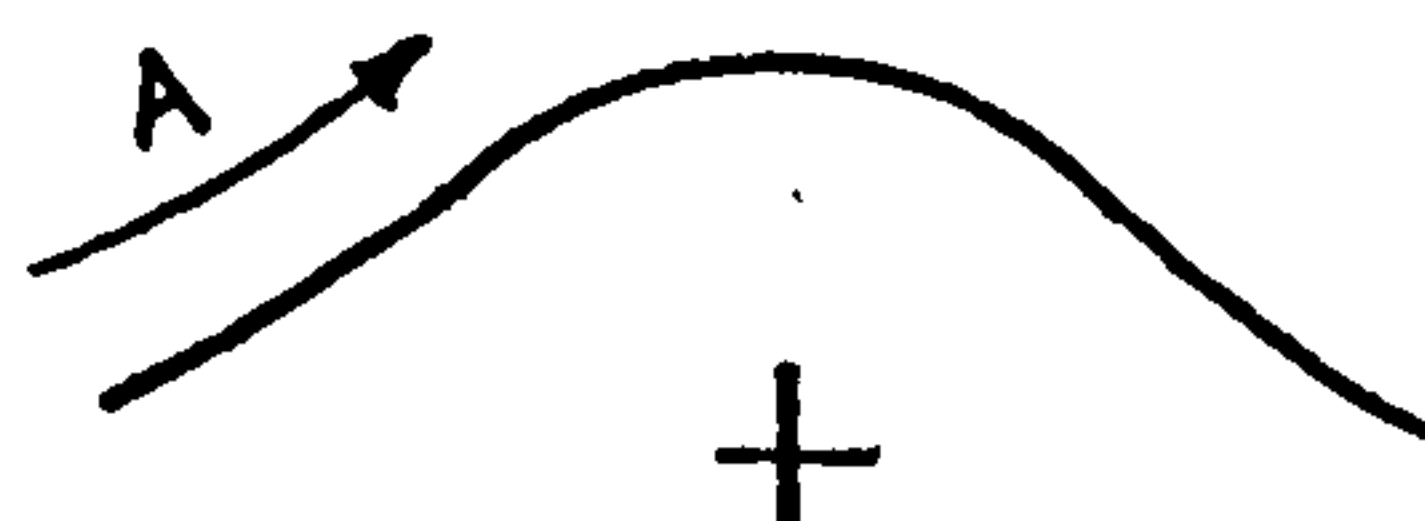

NOTES         1. No plotting takes place



NAME        ARC

FUNCTION    Stores a circular Arc in array

ARGUMENTS  (*ARRAY, X, Y, RADIUS, THETA, PHI, N*)

*ARRAY*    (Real array) stores the Arc

*X, Y*      (Real inches) is the centre of revolution

*RADIUS*   (Real inches) is the radius of curvature

*THETA*    (Real degrees) is the starting angle of the  
Arc

*PHI*      (Real degrees) is the angle of rotation in a  
clockwise sense

*N*        (Integer) is the number of steps to perform  
the rotation

EXAMPLE    *CALL ARC(S, 0.0, 0.0, 5.0, 90.0, 90.0, 20)*

This statement stores an Arc in *S* with the centre of revolution at the origin and radius 5.0 inches. The starting angle is  $90.0^\circ$  and the rotated angle is  $90.0^\circ$ .

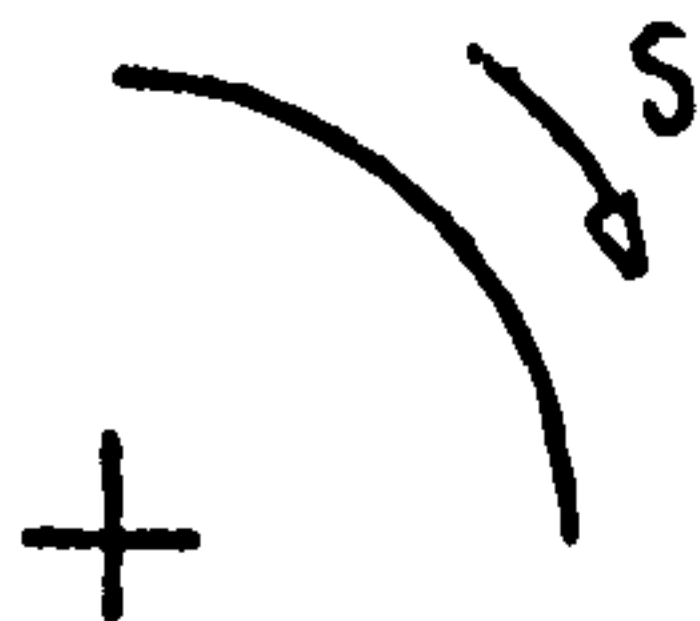

NOTES      1. No plotting takes place

NAME ARRAY1 (One Dimension Array)

FUNCTION Reads in punched card data and stores it in a One Dimension Array

ARGUMENTS (ARRAY, COL)

ARRAY (Real array) is the name of the array

COL (Integer) is the number of columns in the array

SAMPLE CALL ARRAY1(B, 20)

This statement reads in sufficient cards to store 20 numbers in B.

NOTES

1. The format of the cards is (10F8.0) therefore a decimal point should be punched in the data. A number must be punched within its allocated 8 columns.
2. For the above example 2 cards are required but partially punched cards are accepted as the final card.

## PICASO SYSTEM

## ARRAY2

NAME        ARRAY2 (Two Dimension Array)

FUNCTION    Reads in punched card data and stores it in a Two  
             Dimension Array

ARGUMENTS  (*ARRAY, COL, ROW*)

*ARRAY*    (Real array) is the name of the array

*COL*        (Integer) is the number of columns in the  
                      array

*ROW*        (Integer) is the number of rows in the array

EXAMPLE    *CALL ARRAY2(B, 18, 2)*

             This statement reads in sufficient cards to  
             store 36 numbers in *B*.

NOTES        1. The format of the cards is (10F8.0) therefore a  
             decimal point should be punched in the data.  
             A number must be punched within its allocated 8  
             columns.  
             2. For the above example 4 cards are required.

NAME ASPIRA (Archimedean Spiral)

FUNCTION Stores an Archimedean Spiral in array

ARGUMENTS (*ARRAY, RADIUS, CYCLES, N*)

*ARRAY* (Real array) stores the spiral

*RADIUS* (Real inches) is the final radius of the spiral

*CYCLES* (Real) is the number of rotations in the spiral

*N* (Integer) is the number of points in the curve

EXAMPLE *CALL ASPIRA(S, 4.0, 2.0, 60)*

This statement stores an archimedean spiral in the array *S* with 2.0 cycles and a final radius of 4.0 inches.

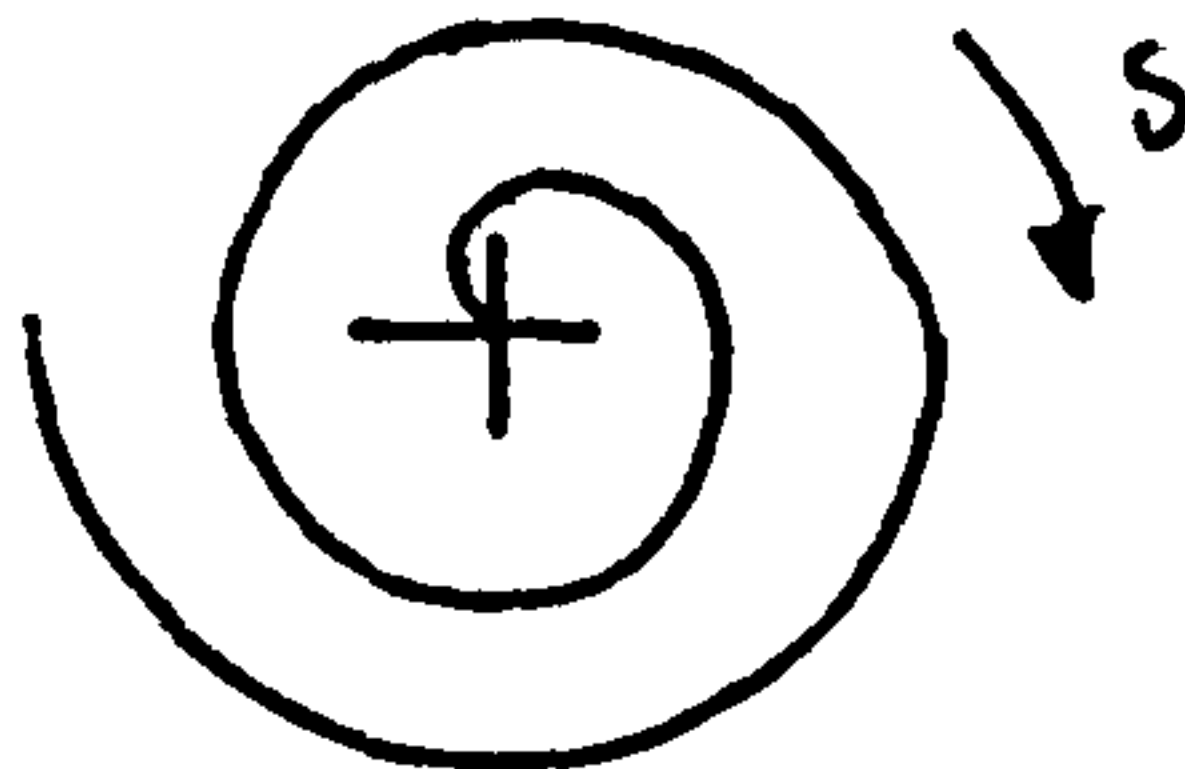

NOTES 1. No plotting takes place

PICASO SYSTEM

ASTROI

**NAME**           ASTROI (Astroid Roemer 1674)

**FUNCTION**   Stores an astroid in array

**ARGUMENTS** (*ARRAY,WIDTH,N*)

*ARRAY*   (Real array) stores the astroid

*WIDTH*   (Real inches) is the maximum radius of the  
astroid

*N*       (Integer) is the number of points in the curve

**EXAMPLE**    *CALL ASTROI(A,2.0,60)*

This statement stores an astroid of 2.0 inches  
radius in A.

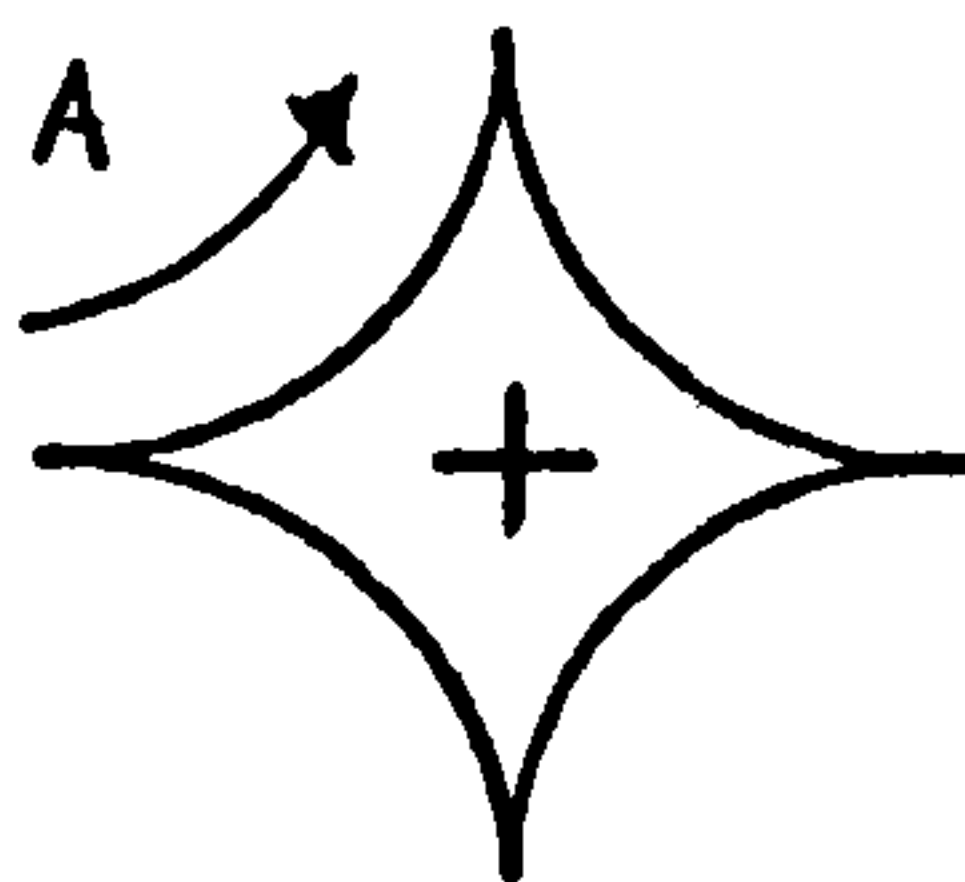

**NOTES**       1. No plotting takes place

NAME BOX

FUNCTION Stores a 3-d *Picasso* box in array

ARGUMENTS (*ARRAY, LENGTH, HEIGHT, WIDTH*)

*ARRAY* (Real array) stores the 3-d *Picasso* box

*LENGTH* (Real inches) is the X-length of the box

*HEIGHT* (Real inches) is the Y-height of the box

*WIDTH* (Real inches) is the Z-depth of the box

EXAMPLE *CALL BOX(B, 2.0, 1.0, 1.0)*

This statement stores a *box* in *B* 2.0 inches long 1.0 inch high and 1.0 inch deep

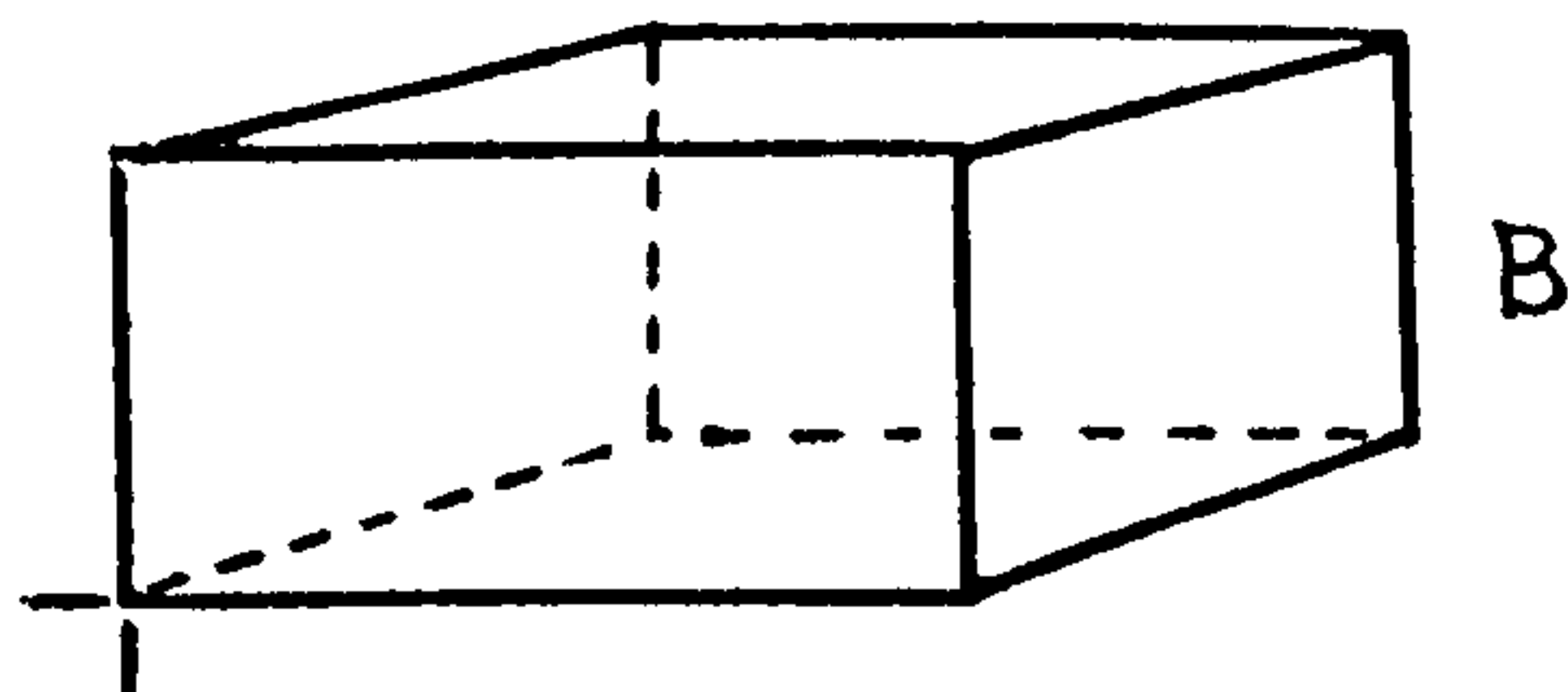

NOTES

1. No plotting takes place
2. Array must be dimensioned (98)

NAME       CARDI (Cardioid)

FUNCTION   Stores a cardioid curve in an array

ARGUMENTS (*ARRAY, XSPAN, N*)

*ARRAY*    (Real array) stores the 2-d *Picasso* cardioid curve

*XSPAN*    (Real inches) is the width of the cardioid from the origin to the right-hand end intersection with the X-axis

*N*         (Integer) the number of steps in the curve

EXAMPLE    *CALL CARDI(C, 4.0, 50)*

This statement stores in array *C* a cardioid curve 4.0 inches wide in 50 steps

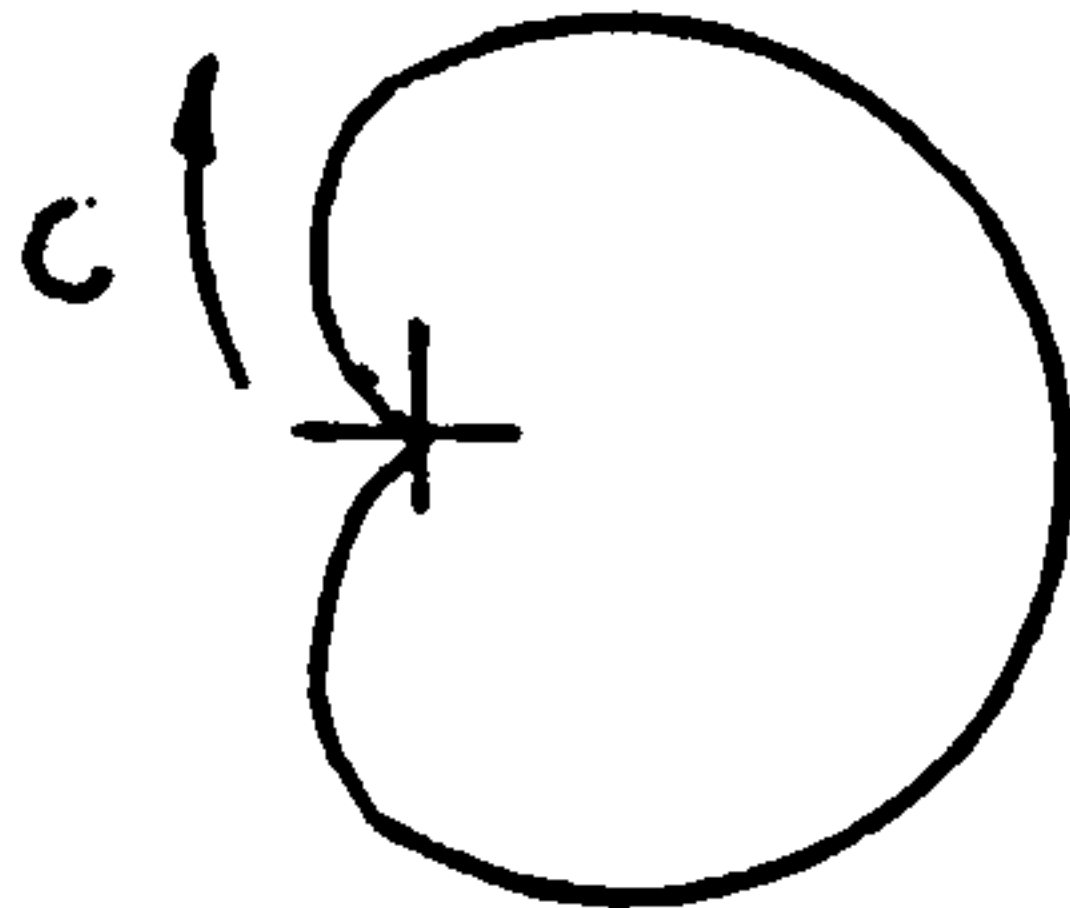

NOTES      1. No plotting takes place

NAME       CLOCK (Clockwise)

FUNCTION   Determines whether a 2-d *Picaso* contour is clockwise  
            or anti-clockwise

ARGUMENTS  (*ARRAY,N*)

*ARRAY*   (Real array) stores a 2-d *Picaso* shape

*N*       (Integer) is the number of the contour

EXAMPLE    *I=CLOCK(BOX,1)*

            This statement sets *I.TRUE.* if the first  
            contour of *box* is clockwise else *I* is *.FALSE.*

NOTES       1. Clock is a logical function



**NAME** CLOK3D (Clockwise 3-d)

**FUNCTION** Determines whether a 3-d *Picaso* contour is clockwise or anti-clockwise

**ARGUMENTS** (*ARRAY,N,SIZE,X,Y,Z*)

*ARRAY* (Real array) stores a 3-d *Picaso* object

*N* (Integer) references the contour

*SIZE* (Real) is the degree of enlargement or reduction

*X,Y,Z* (Real) is the amount of shift applied to the object

**EXAMPLE** *I=CLOK3D(BOX,1,1.0,0.0,0.0,0.0)*

This statement sets *I* *.TRUE.* if the 1st contour of *box* is clockwise else *I* is set *.FALSE.*

**NOTES** 1. Clok3d is a logical function

NAME           CLOSED

FUNCTION       Determines whether a 2-d *Picasso* contour is open or  
                  closed

ARGUMENTS     (*ARRAY,NC*)

*ARRAY*       (Real array) stores a 2-d *Picasso* shape

*NC*           (Integer) is the number of the contour

EXAMPLE       *J=CLOSED(BOX,1)*

*J* is set *.TRUE.* if the first contour of *box*  
is closed, else *J* is *.FALSE.*

NAME            CONECT (Connect)

FUNCTION       Draws out a 2-d *Picaso* shape and connects every vertex with every other vertex with lines

ARGUMENTS     (*ARRAY, SIZE, XS, YS*)

*ARRAY*        (Real array) stores a 2-d *Picaso* shape

*SIZE*         (Real) is the degree of enlargement or reduction of the drawn shape relative to the original stored in array

*XS, YS*       (Real inches) is the degree of shift applied to the shape

EXAMPLE       *CALL CONECT(HEX, 1.0, 0.0, 5.0)*

This statement draws out the shape shown below, assuming that *hex* stores a hexagon

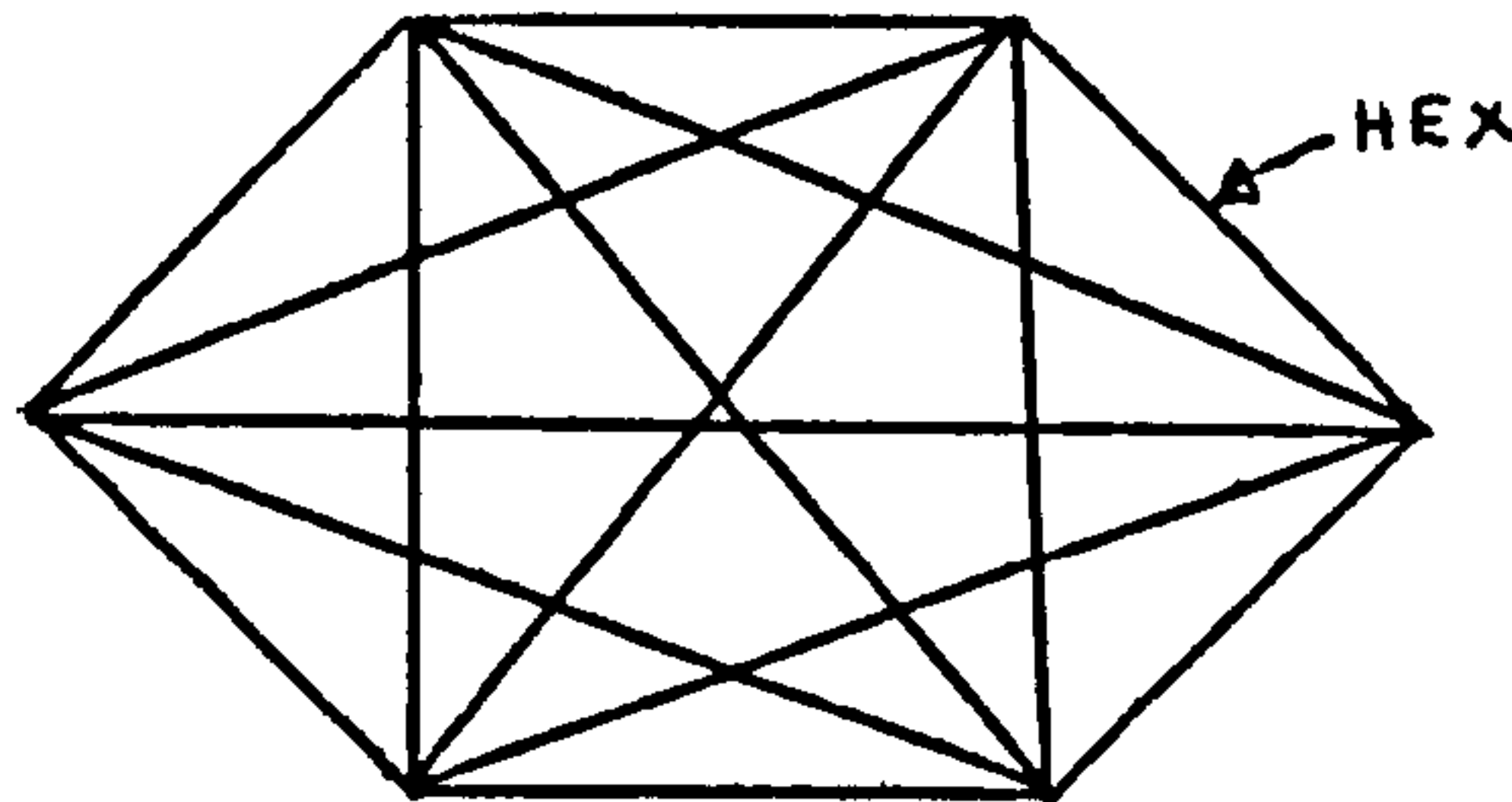

NOTES          1. The *Picaso* shape may be open or closed

(1)26.03.75

**NAME** COPYSH (Copy Shape)

**FUNCTION** Makes a copy of a *Picaso* shape

**ARGUMENTS** (*ARRAY1*,*ARRAY2*)

*ARRAY1* (Real array) stores a *Picaso* shape or object

*ARRAY2* (Real array) stores a copy of the shape or object stored in *Array1*.

**EXAMPLE** *CALL COPYSH(A,B)*

This statement copies the shape or object stored in *A* into *B*.

**NOTES** 1. No plotting takes place

NAME CROSS

FUNCTION Determines whether two lines cross, and the nature and type of intersection

ARGUMENTS  $(X1, Y1, X2, Y2, X3, Y3, X4, Y4, XI, YI)$

$X1, Y1$  (Real) is the first point on the reference line

$X2, Y2$  (Real) is the last point on the reference line

$X3, Y3$  (Real) is the first point on the test line

$X4, Y4$  (Real) is the last point on the test line

$XI, YI$  (Real) is the point of intersection if the lines cross or touch

EXAMPLE  $I=CROSS(0.0, 0.0, 1.0, 1.0, XA, YA, XB, YB, XI, YI)$

This statement determines if the given two lines intersect

NOTES 1. The following illustrate the type of intersections

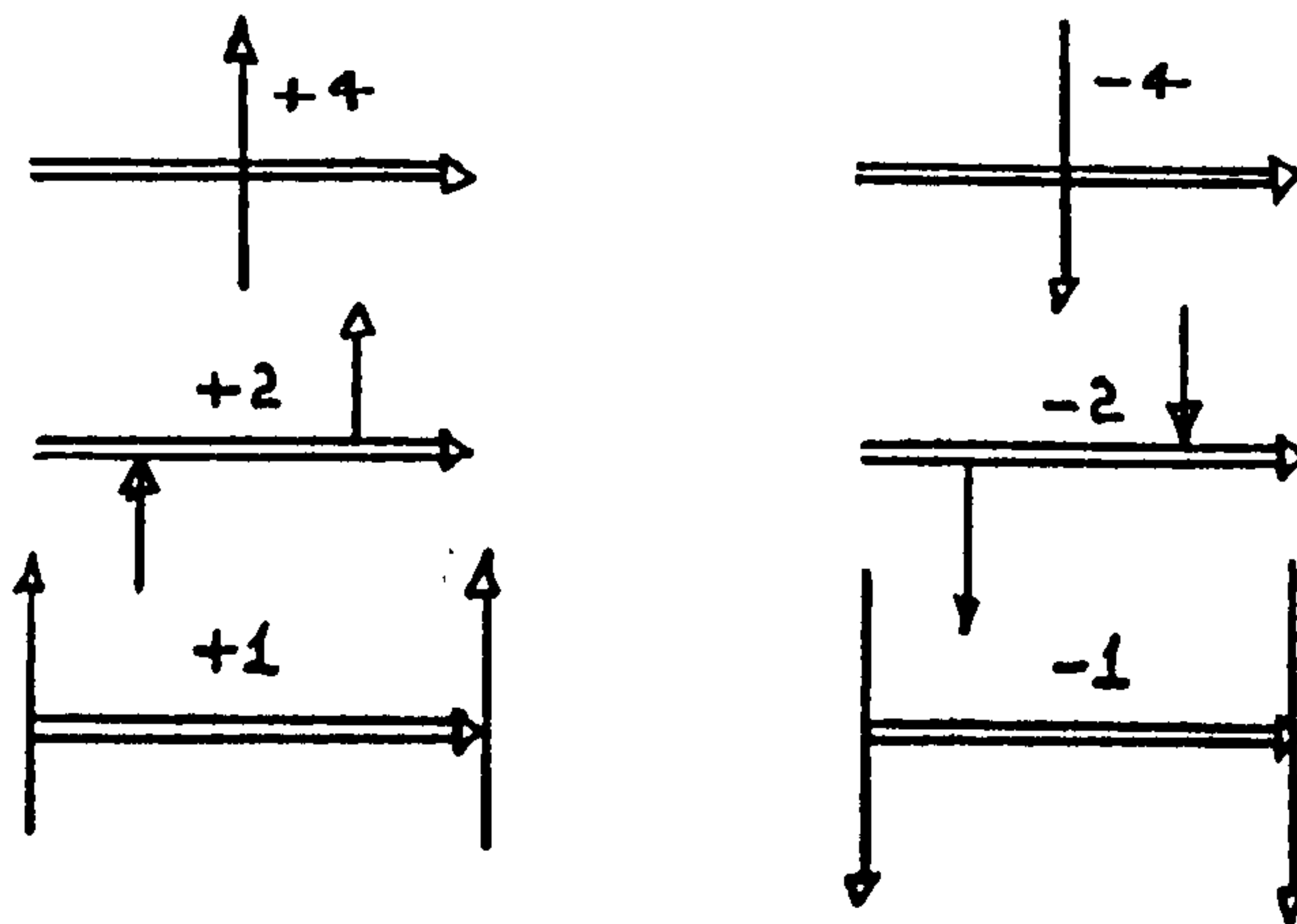

2. Cross is an integer type function

NAME CUBE

FUNCTION Stores a regular cube in a *Picasso* array

ARGUMENTS (*ARRAY*, *SIDE*)

*Array* (Real array) receives the cube

*Side* (Real inches) is the size of the cube

EXAMPLE *CALL CUBE(C,1.0)*

This statement stores a *cube* size 1.0" in *C*  
Array *C* must be dimensioned *C(98)*

NOTES

1. All surfaces are clockwise
2. The lower left-hand corner is on the origin

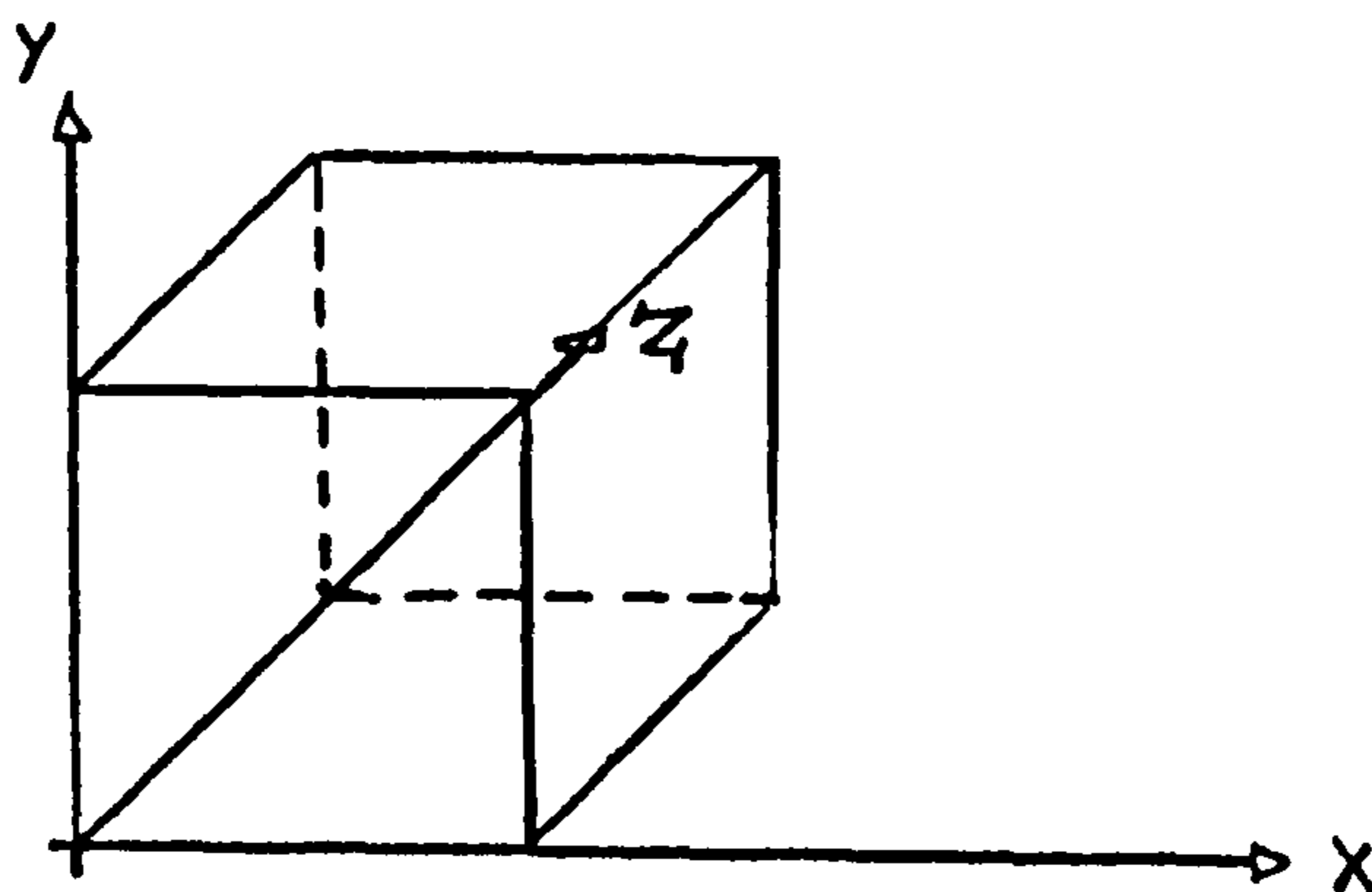

NAME CUBPAR (Cubic Parabola)

FUNCTION Stores a cubic parabola in array

ARGUMENTS (*ARRAY, XSPAN, YSPAN, N*)

*ARRAY* (Real array) stores the cubic parabola

*XSPAN* (Real inches) is the X-width of the curve  
from the origin

*YSPAN* (Real inches) is the height of the curve

*N* (Integer) is the number of points in the  
curve

EXAMPLE *CALL CUBPAR(C, 2.0, 2.0, 20)*

This statement stores a cubical parabola in  
*C* 4.0 inches wide 2.0 inches high

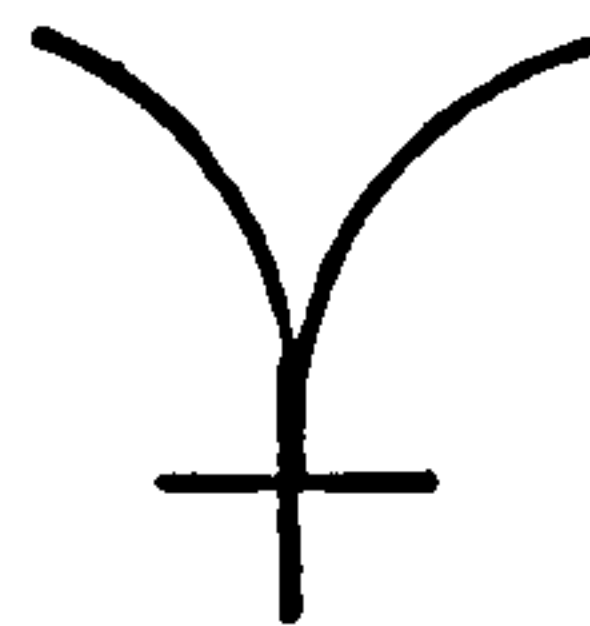

NOTES 1. No plotting takes place

NAME CYCLE (Re-cycle coordinates)

FUNCTION Takes every point defining a 2-dimensional *Picasso* shape and moves it clockwise or anti-clockwise towards its nearest neighbour

ARGUMENTS (*ARRAY, K, F, ARRAY1*)

*ARRAY* (Real array) stores a 2-dimensional *Picasso* shape

*K* (Integer) +VE = Clockwise  
-VE = Anti-clockwise

*F* (Real) is the degree of rotation minimum value = 0.0 max = 1.0

*ARRAY1* (Real array) stores the cycled shape

EXAMPLE *CALL CYCLE(SQUARE, 1, 0.5, SQUARE)*

This statement takes the shape stored in *square* and rotates the points clockwise by 50%. The cycled shape is re-stored in *square*.

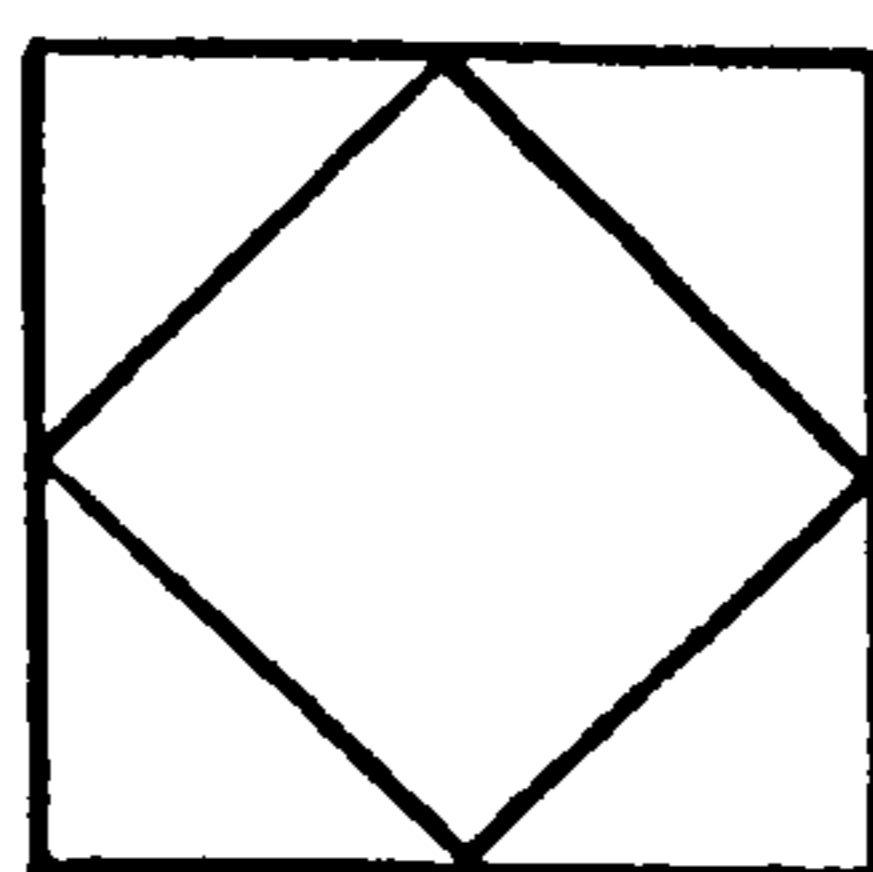

NOTES 1. No plotting takes place



NAME DELTOI (Deltoid)

FUNCTION Stores a deltoid curve in array

ARGUMENTS (*ARRAY,RADIUS,N*)

*ARRAY* (Real array) stores the deltoid curve

*RADIUS* (Real inches) is the maximum radius of the deltoid

*N* (Integer) is the number of points in the curve

EXAMPLE *CALL DELTOI(D,1.0,50)*

This statement stores a *Deltoid* in *D* of radius 1.0 using 50 points

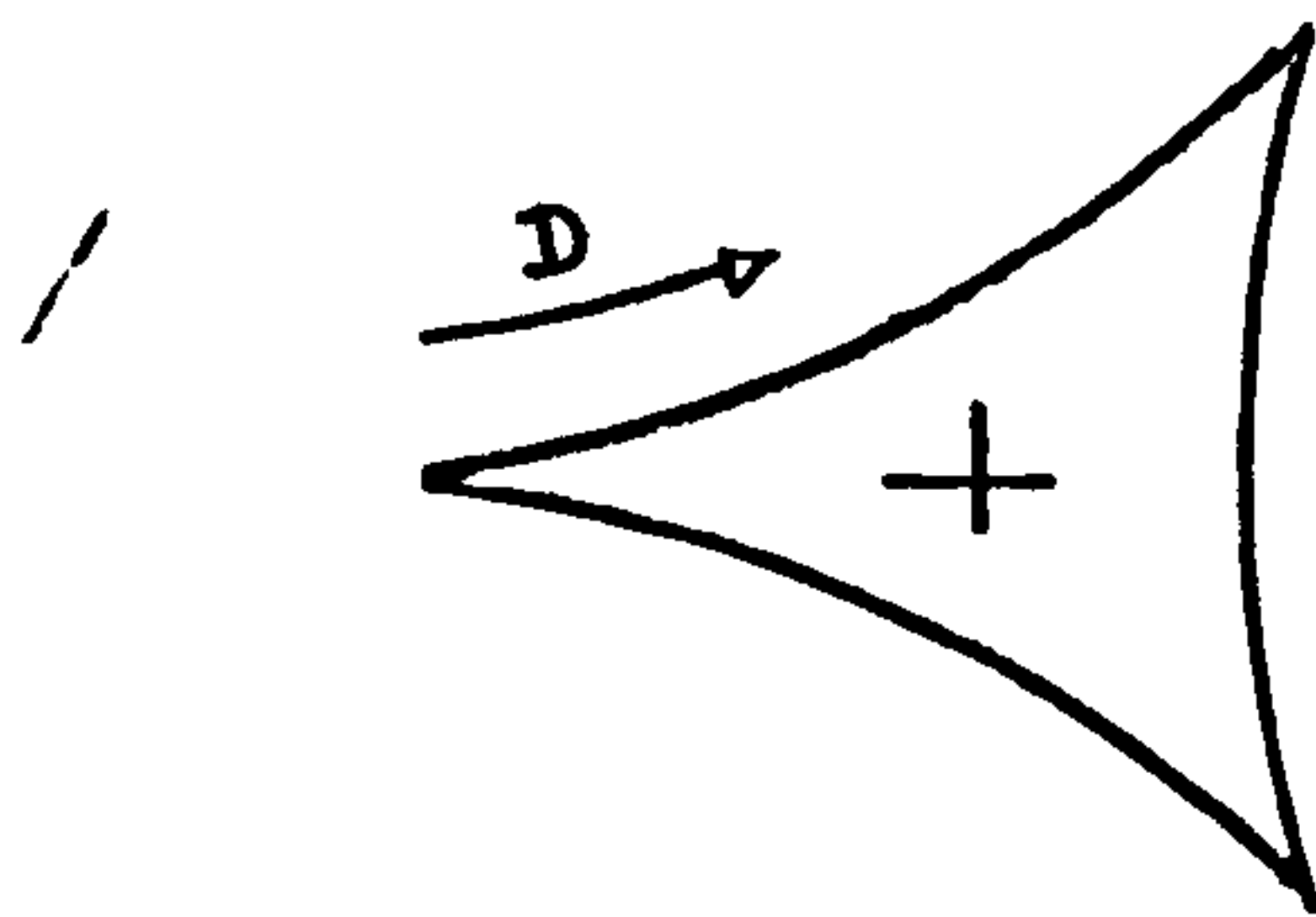

NOTES 1. No plotting takes place

NAME            DOT

FUNCTION      Stores the coordinates of a point

ARGUMENTS    (*ARRAY, X, Y*)

*ARRAY*       (Real array) stores the dot

*X, Y*        (Real inches) is the dot location

EXAMPLE      *CALL DOT(D, 5.0, 5.0)*

              This statement stores the position of a *dot*  
              in *D*.

• (**DOT**)

NOTES        1. No plotting takes place

NAME DRAW

FUNCTION Plots a 2-dimensional *Picaso* shape

ARGUMENTS (*ARRAY, SIZE, X, Y*)

*ARRAY* (Real array) stores a 2-d *Picaso* shape

*SIZE* (Real) is the degree of enlargement or reduction of the drawn shape relative to the original stored in array

*X, Y* (Real inches) is the amount of shift applied to the drawn shape

EXAMPLE *CALL DRAW(BOX, 2.0, 5.0, 5.0)*

This statement draws out the shape stored in *box* twice its original size displaced 5.0 inches along the *X-axis* and 5.0 inches along the *Y-axis*.

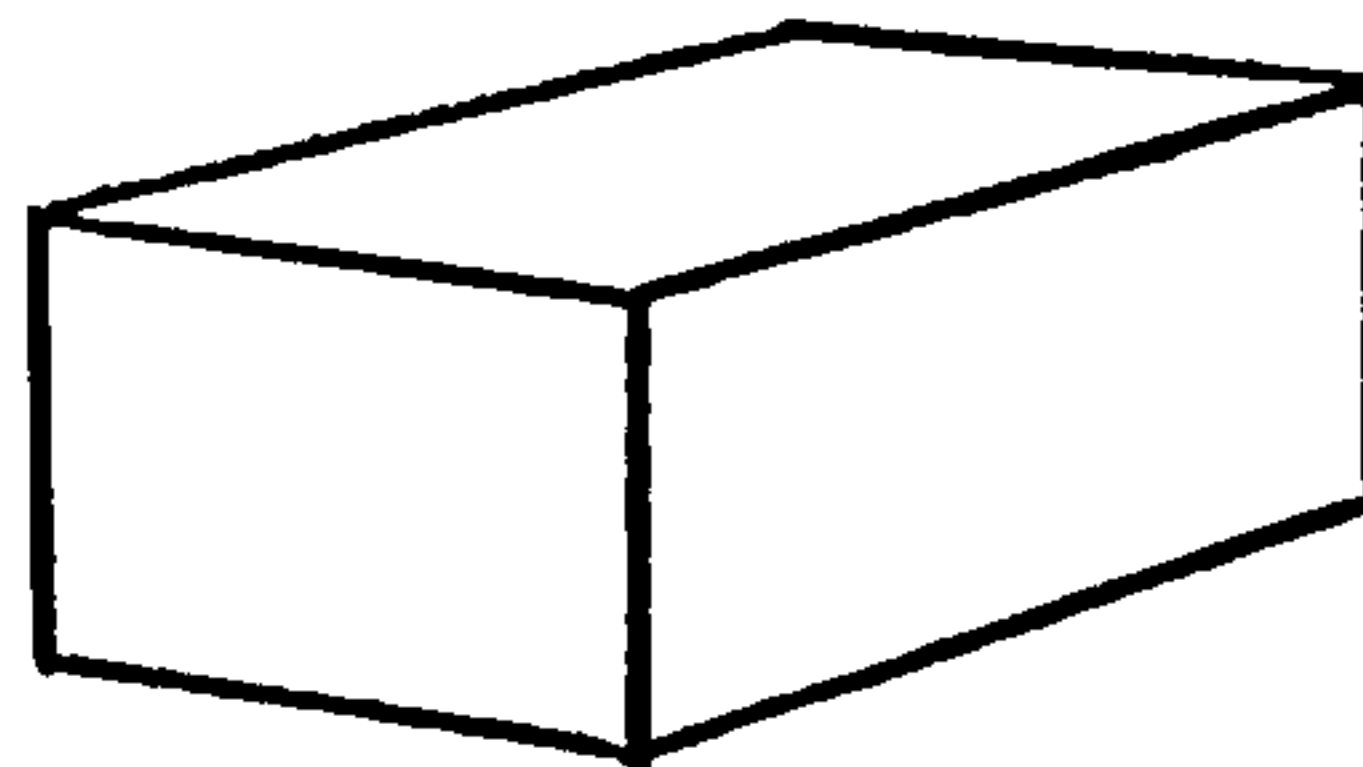

NOTES 1. All size changes are made relative to the origin, for example the point (1.0,1.0) with a size value of 2.0 is transformed to (2.0,2.0).

NAME DRAW2D (Draw a 2-d shape in 3-d)

FUNCTION Draws out a 3-d version of a 2-d *Picasso* shape by transposing coordinates

ARGUMENTS (ARRAY, SIZE, X, Y, N1, N2, N3, V)

ARRAY (Real array) stores a 2-d *Picasso* shape

SIZE (Real) is the degree of enlargement or reduction

X, Y (Real) is the degree of shift applied to the 2-d shape

N1, N2, N3 (Integer) determine the transposition

N1	N2	N3	X	Y	Z	IN 3-D
1	2	3	X	Y	V	
1	3	2	X	V	Y	
2	1	3	Y	X	V	
3	1	2	V	X	Y	IN 2-D
2	3	1	Y	V	X	
3	2	1	V	Y	X	

V (Real) is the value for the third dimension

EXAMPLE `CALL DRAW2D(A, 1.0, 0.0, 0.0, 3, 1, 2, 2.0)`

This statement produces the following transformation

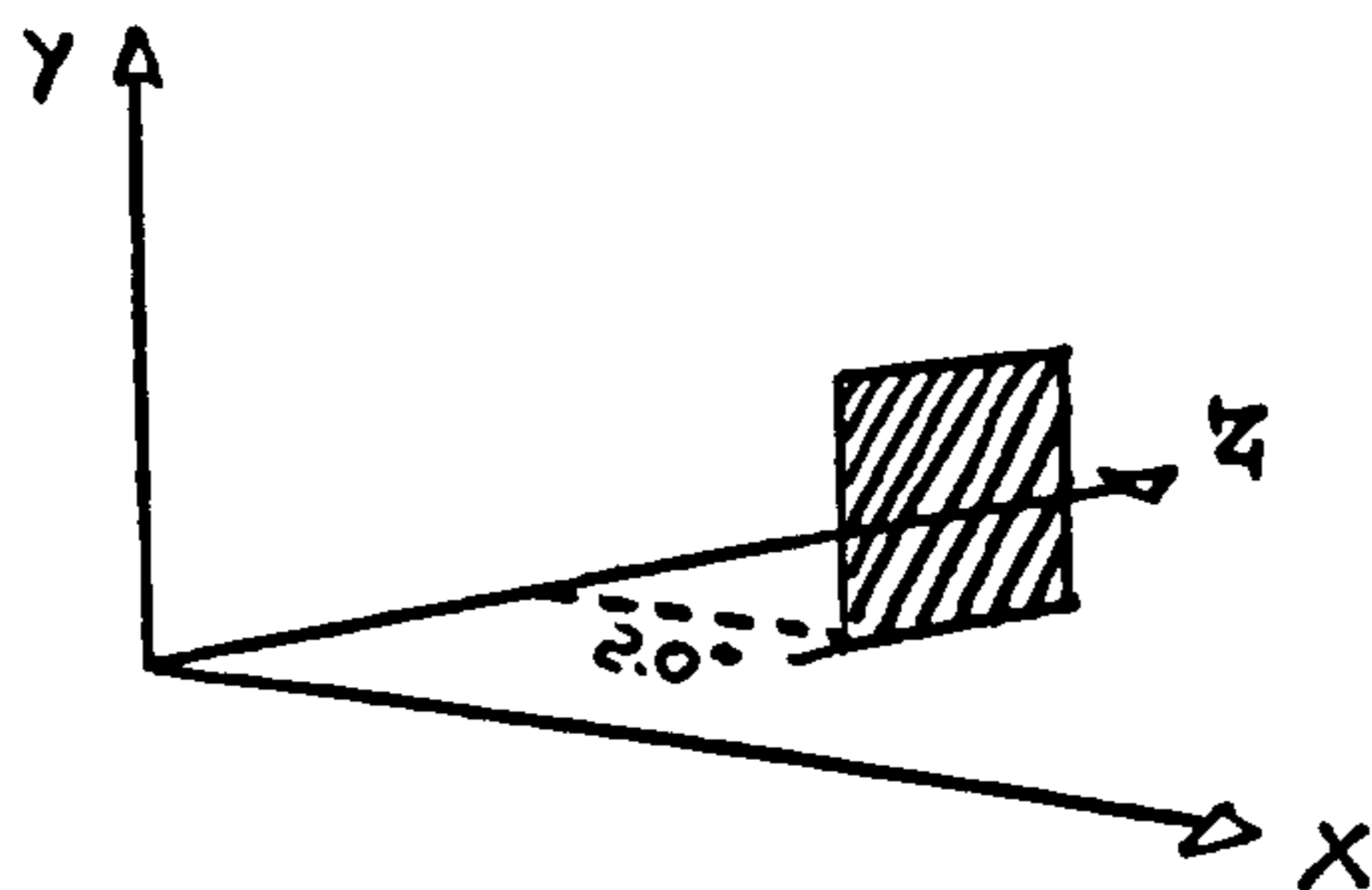

NOTES 1. The position of the eye is set by 'eye'

NAME DRAW3D (Draw a 3-d Object)

FUNCTION Draws out a 3-d view of a 3-d *Picaso* object

ARGUMENTS (*ARRAY, SIZE, X, Y, Z, L*)

*ARRAY* (Real array) stores a 3-d *Picaso* object

*SIZE* (Real) is the degree of enlargement or reduction

*X, Y, Z* (Real) is the degree of shift applied to the object

*L* (Integer) if *L* is +VE all lines are drawn. If *L* is -VE some hidden-line removal occurs

EXAMPLE *CALL DRAW3D(BOX, 1.0, 0.0, 0.0, 0.0, -1)*

This statement draws out the object stored in *box* with hidden-line removal

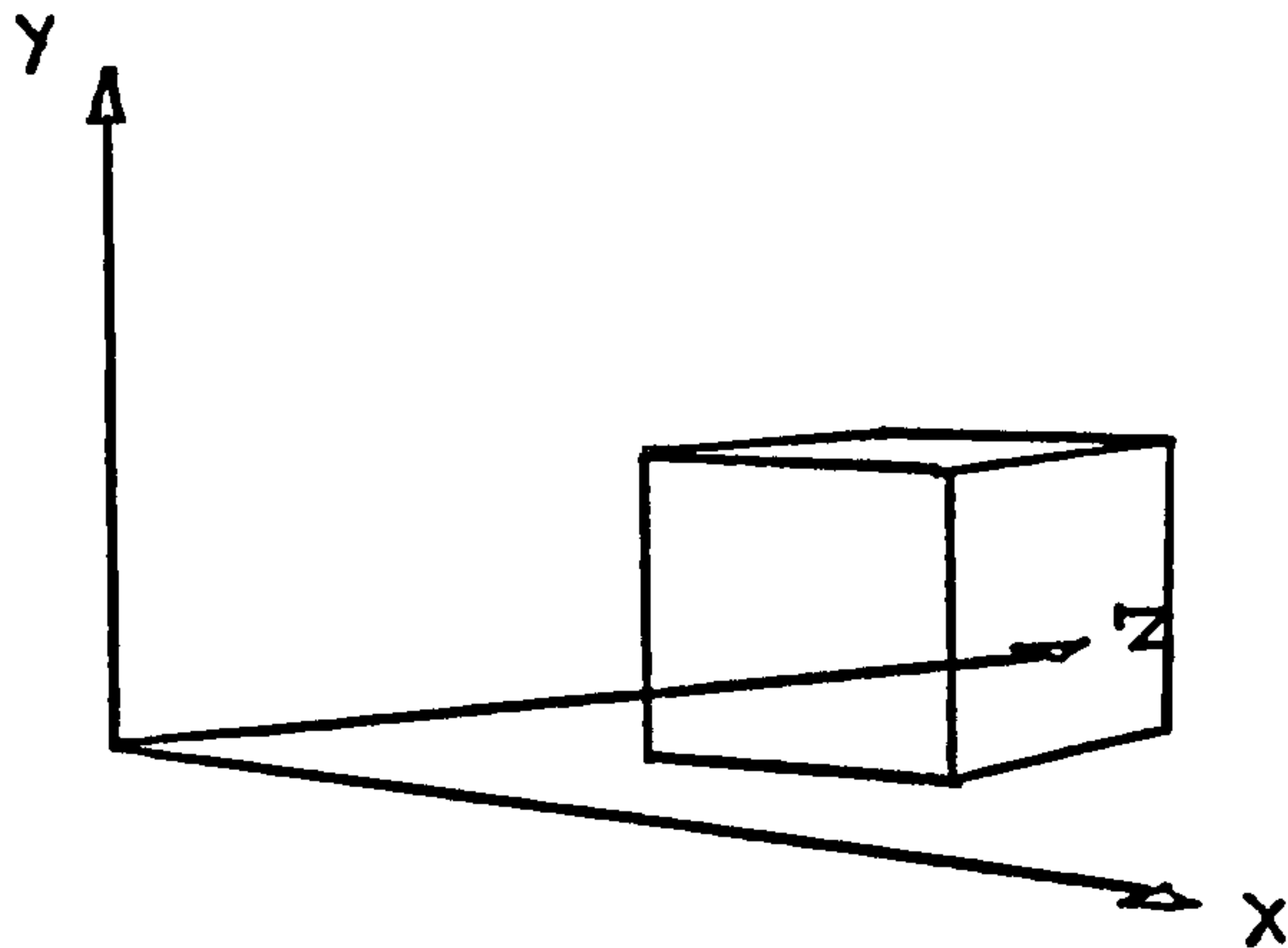

NOTES The position of the eye is set up by 'eye' or 'fishi'

NAME DSHAPE (Dash Shape)

FUNCTION Draws out the 2-dimensional *Picasso* shape with broken lines

ARGUMENTS (*ARRAY, SIZE, X, Y, DASH*)

*ARRAY* (Real array) stores a 2-d *Picasso* shape

*SIZE* (Real) is the degree of enlargement or reduction of the drawn shape relative to the original stored in array

*X, Y* (Real inches) is the amount of shift applied to the drawn shape

*DASH* (Real inches) is the length of the dash

EXAMPLE *CALL DSHAPE(BOX, 1.0, 0.0, 0.0, 0.1)*

This statement draws out the shape stored in *box* at its original size with zero displacement. The broken line is 0.1 inch

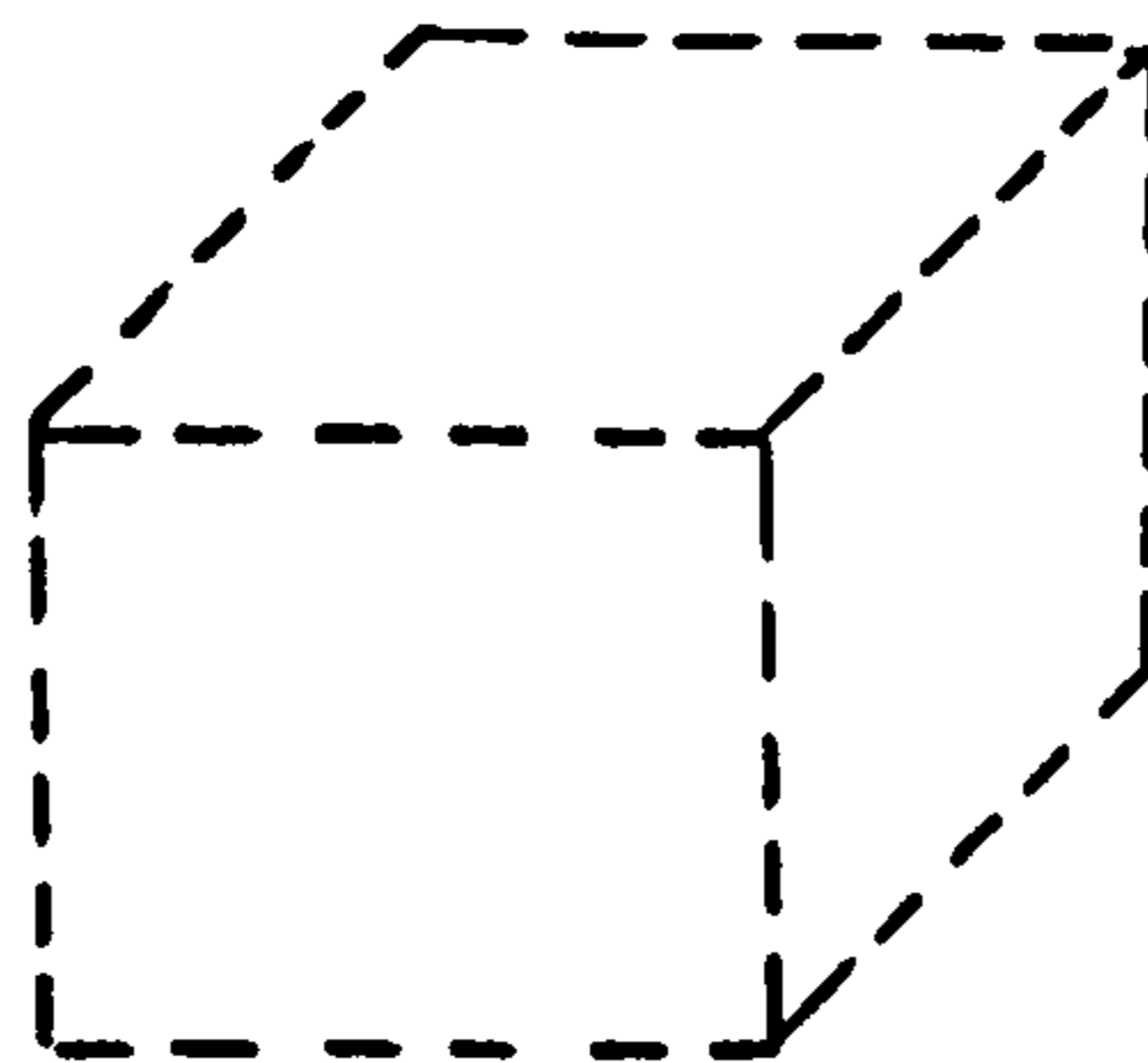

## PICASO SHAPE

## DSHLNE

NAME DSHLNE (Dashed Line)

FUNCTION Draws a broken line between two points

ARGUMENTS  $(X1, Y1, X2, Y2, DASH)$

$X1, Y1$  (Real inches) coordinate of 1st point

$X2, Y2$  (Real inches) coordinate of 2nd point

$DASH$  (Real inches) is the length of the broken line

EXAMPLE *CALL DSHLNE (0.0,0.0,4.0,5.0,0.25)*

This statement draws a broken line in lengths  $\frac{1}{4}$  inch long between the origin and the point  $(4.0, 5.0)$ .

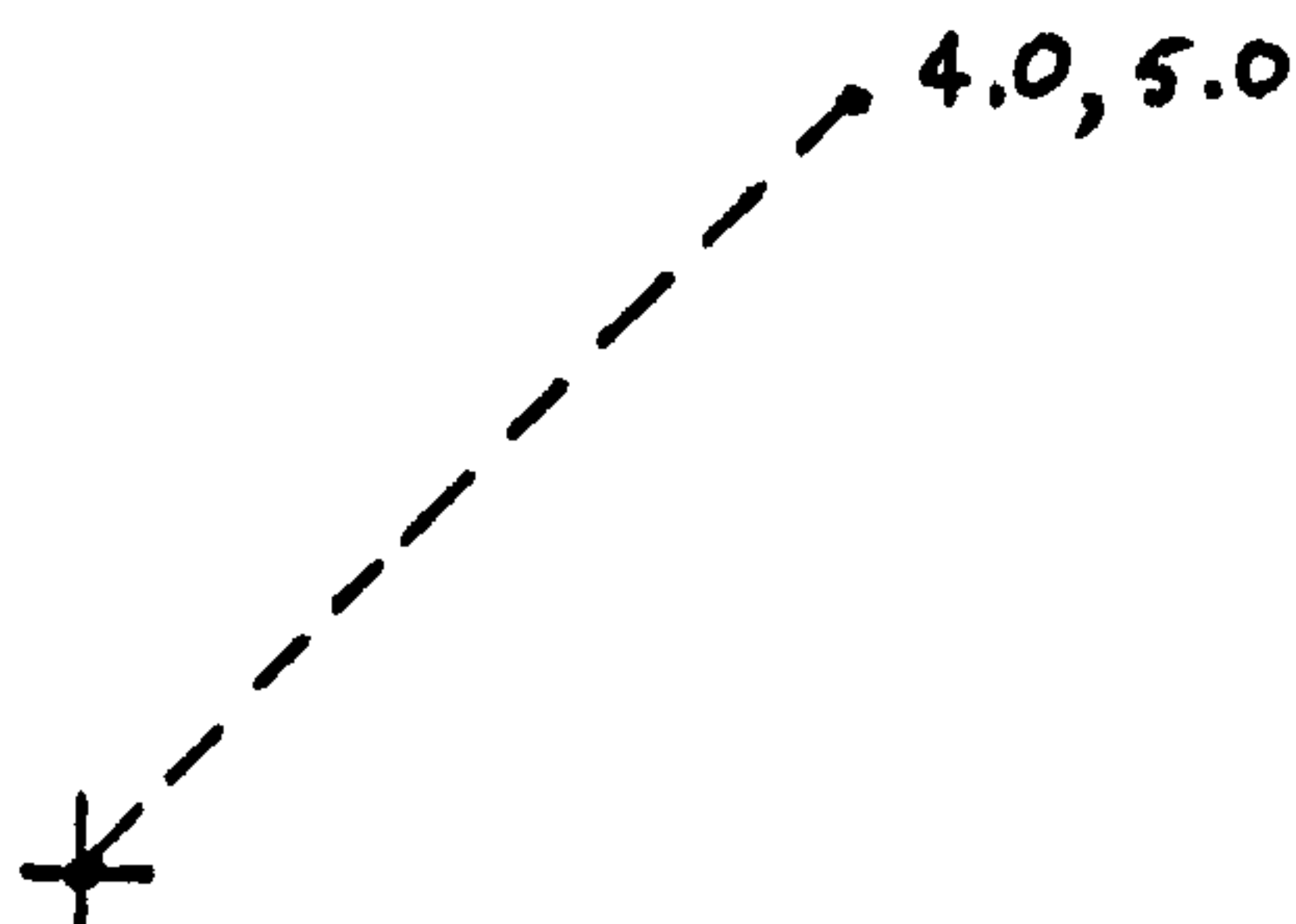

NAME        ELLIPS (Ellipse)

FUNCTION   Stores an ellipse in array

ARGUMENT   (*ARRAY, MAJOR, MINOR, N*)

*ARRAY*    (Real array) stores the ellipse

*MAJOR*    (Real inches) is the major radius of the ellipse

*MINOR*    (Real inches) is the minor radius of the ellipse

*N*        (Integer) is the number of points on the curve

EXAMPLE    *CALL ELLIPS(E, 4.0, 2.0, 60)*

This statement stores an *Ellipse* in *E* with diameters 8.0 inches by 4.0 inches

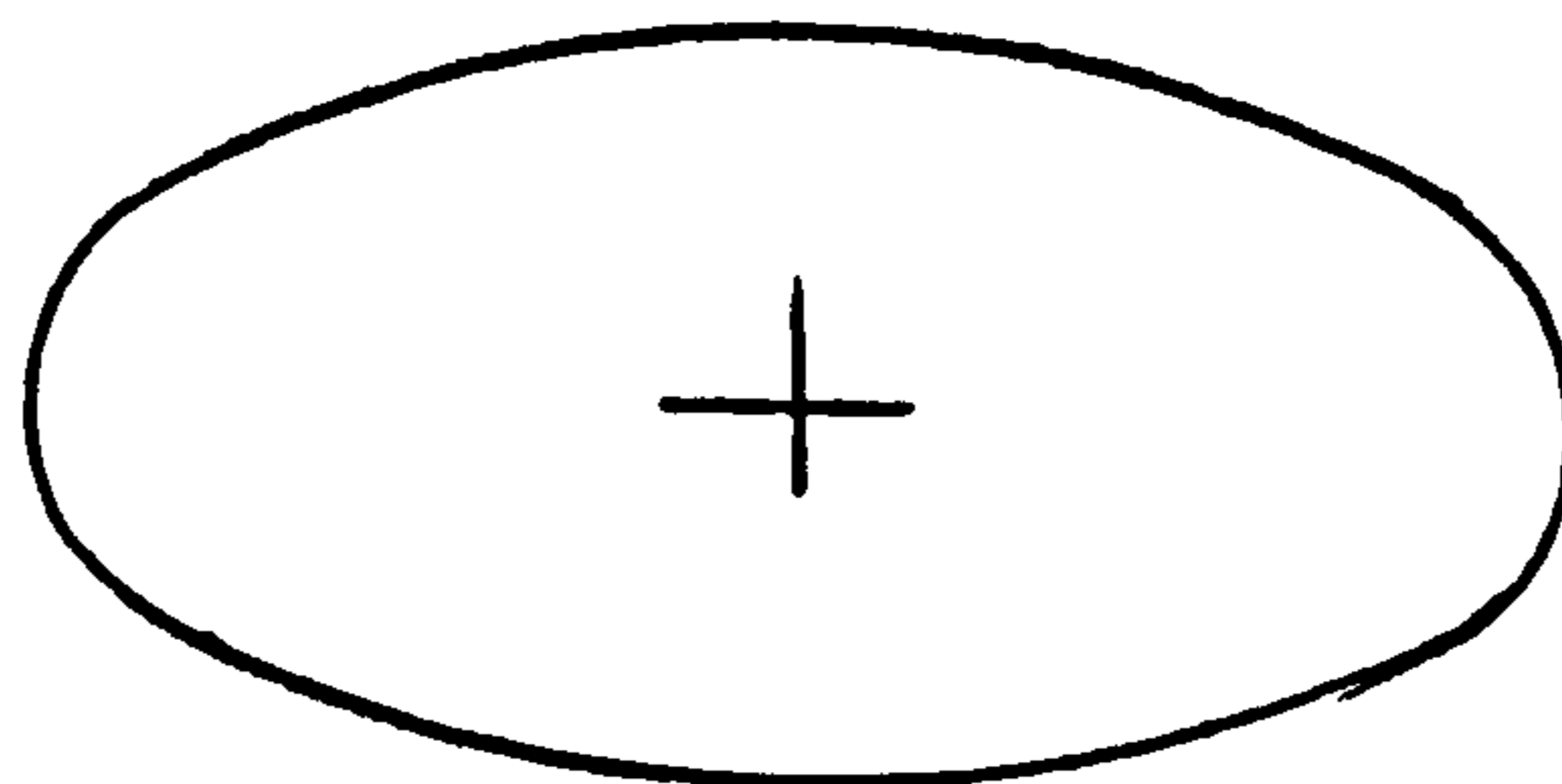

NOTES      1. No plotting takes place



NAME EPITRO (Epitrochoid)

FUNCTION Stores a epitrochoid in array

ARGUMENTS (*ARRAY,RADFIX,RADMOV,DIST,N*)

*ARRAY* (Real array) stores the 2-d epitrochoid

*RADFIX* (Real inches) is the radius of the fixed circle

*RADMOV* (Real inches) is the radius of the moving circle

*DIST* (Real inches) is the distance of the traced point that exists on the moving circle to its centre

*N* (Integer) is the number of points on the curve

EXAMPLE *CALL EPITRO(E,2.0,1.0,1.0,60)*

This statement represents a 1.0" radius circle moving around a fixed 2.0" radius circle. The point traced is 1.0" from the centre.

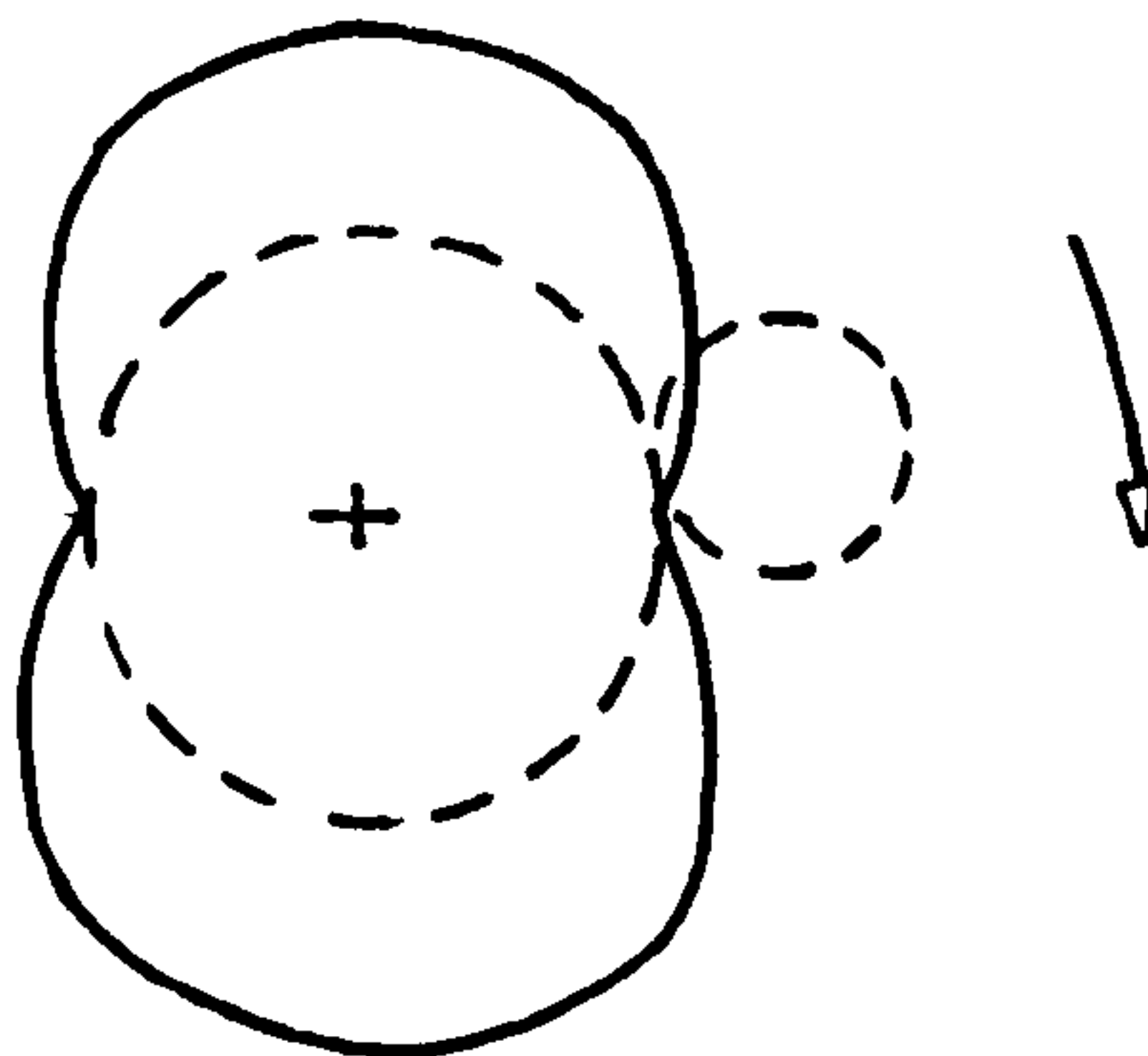

NAME EXPLOD (Explode)

FUNCTION Adjusts the size of a shape relative to a specified point

ARGUMENTS (*ARRAY,XP,YP,F,ARRAY2*)

*ARRAY* (Real array) stores the two-dimension *Picaso* shape

*XP,YP* (Real inches) is the centre of the explosion

*F* (Real) is the degree of size change

*ARRAY2* (Real array) stores the exploded shape

EXAMPLE *CALL EXPLOD(BOX,0.0,0.0,2.0,BOX)*

This statement doubles the size of the shape stored in *box* about the origin

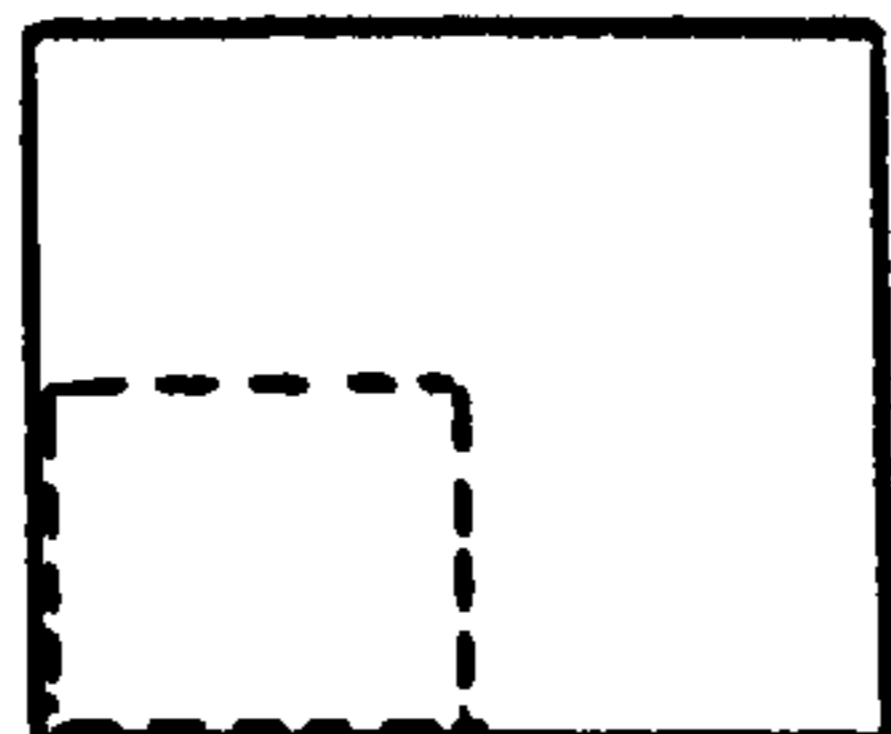

NOTES 1. No plotting takes place

NAME EXTSH (Extract shape)

FUNCTION Extracts a contour from a 2-dimensional *Picaso* shape

ARGUMENTS (*ARRAY, NC, CONTOR*)

*ARRAY* (Real array) stores the 2-d *Picaso* shape

*NC* (Integer) references the contour to be extracted

*CONTOR* (Real array) receives the extracted contour

EXAMPLE *CALL EXTSH(BOX,1,C)*

This statement extracts the *first* contour of *box* and stores it in *C*.

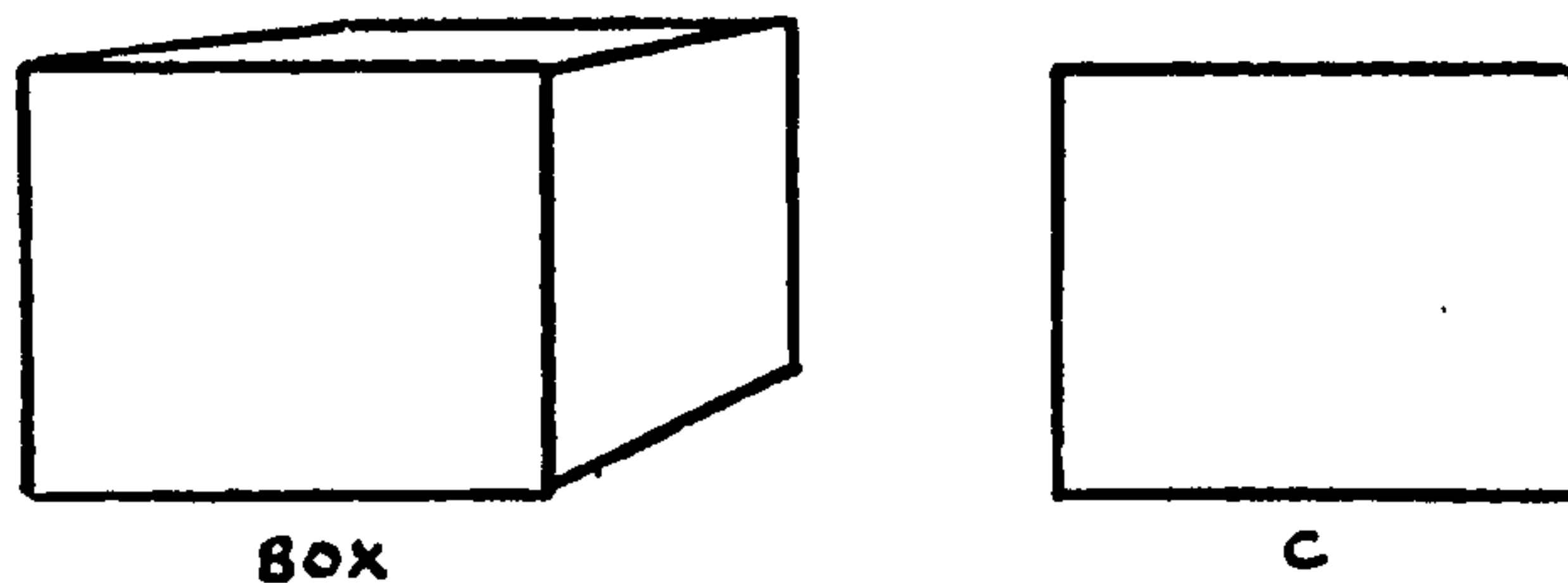

NOTES 1. No plotting takes place

NAME EYE

FUNCTION Establishes the position of the eye and the point under observation

ARGUMENTS  $(XE, YE, ZE, X, Y, Z)$

$XE, YE, ZE$  (Real inches) are the coordinates of the eye in 3-d space

$X, Y, Z$  (Real inches) are the coordinates of the point in space the eye is looking towards

EXAMPLE `CALL EYE(0.0,0.0,0.0,0.0,5.0,10.0)`

This statement places the *eye* at the origin and points it towards the point specified

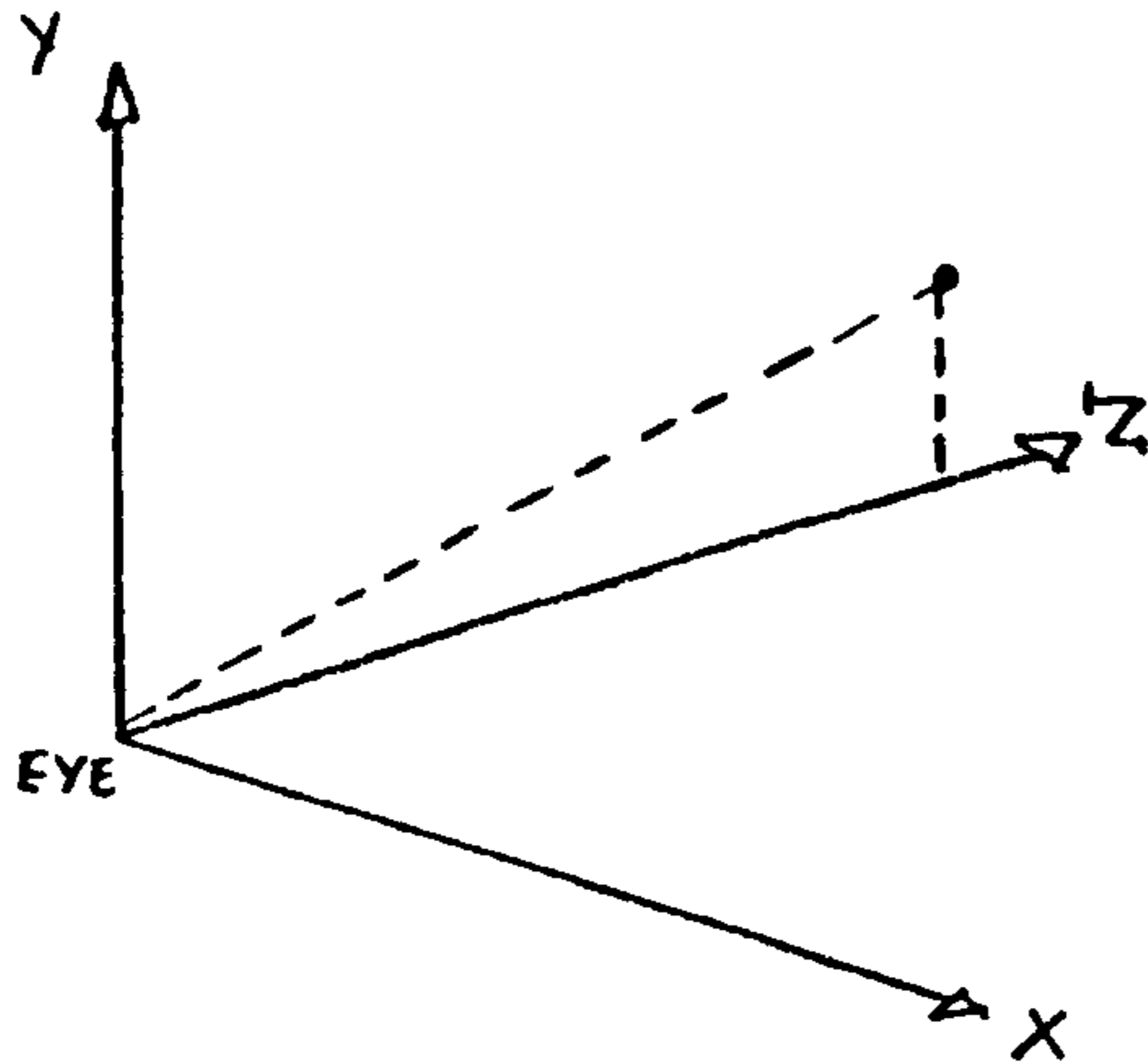

- NOTES
1. Eye must be called before calling any 3-d sub-routine
  2. The picture plane is set 10.0 inches from the eye
  3. Eye may be called many times
  4. The point the eye is looking at is centered on the origin

NAME FILL

FUNCTION Draws a regular grid of 2-d *Picasso* shapes allowing for alternate horizontal and vertical shift to be applied

ARGUMENTS (*ARRAY, SIZE, NX, XSP, XSH, NY, YSP, YSH, X, Y*)

*ARRAY* (Real array) stores a 2-d *Picasso* shape

*SIZE* (Real) is the degree of enlargement or reduction of the drawn shape relative to the original stored in array

*NX* (Integer) is the number of shapes in the 'X' direction

*XSP* (Real inches) is the distance between points on two shapes in the 'X' direction

*XSH* (Real inches) is the amount of shift applied to even numbered rows

*NY* (Integer) is the number of shapes in the 'Y' direction

*YSP* (Real inches) is the distance between points on two shapes in the 'Y' direction

*YSH* (Real inches) is the amount of shift applied to even numbered columns

*X, Y* (Real inches) is the amount of shift applied to the entire grid

EXAMPLE *CALL FILL(HEX, 1.0, 3, 1.50, 0.0, 2, 1.732, 0.5, 0.0, 0.0)*

This statement produces a tessellated space of Hexagons (assuming *Hex* stored a Hexagon)

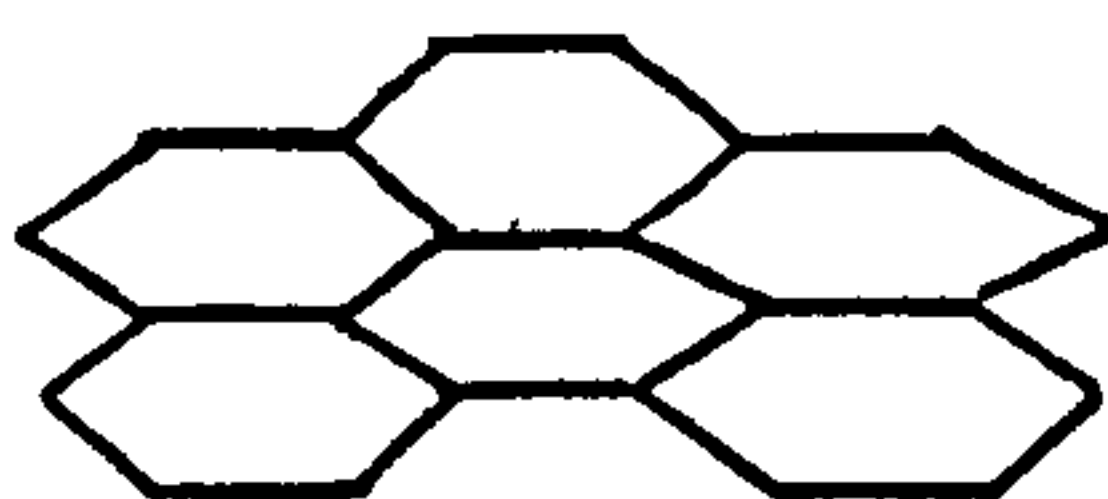

**NAME** FILL2D (Draw a 2-d grid in 3-d)

**FUNCTION** Draws out a three-dimensional version of a 2-d *Picasso* shape

**ARGUMENTS** (*ARRAY, SIZE, X, Y, NX, XSP, XSH, NY, YSP, YSH, N1, N2, N3, V*)

*ARRAY* (Real array) stores a 2-d *Picasso* shape

*SIZE* (Real) is the size factor

*X, Y* (Real inches) is the degree of shift applied to the 2-d shape

*NX* (Integer) is the number of shapes in the 'x' direction

*XSP* (Real inches) is the distance between points on two shapes in the 'x' direction

*XSH* (Real inches) is the amount of shift applied to even numbered rows

*NY* (Integer) is the number of shapes in the 'y' direction

*YSP* (Real inches) is the distance between points on two shapes in the 'y' direction

*YSH* (Real inches) is the amount of shift applied to even numbered columns

*N1, N2, N3* (Integer) determine the transformation

N1	N2	N3	X	Y	Z	IN 3-D
1	2	3	X	Y	V	
1	3	2	X	V	Y	
2	1	3	Y	X	V	
3	1	2	V	X	Y	IN 2-D
2	3	1	Y	V	X	
3	2	1	V	Y	X	

*V* (Real) is the value for the third dimension

EXAMPLE `CALL FILL2D(HEX,1.0,0.0,0.0,3,1.5,0.0,2,1.732,0.5,1,2,3,2.0)`

This statement produces the following transposition

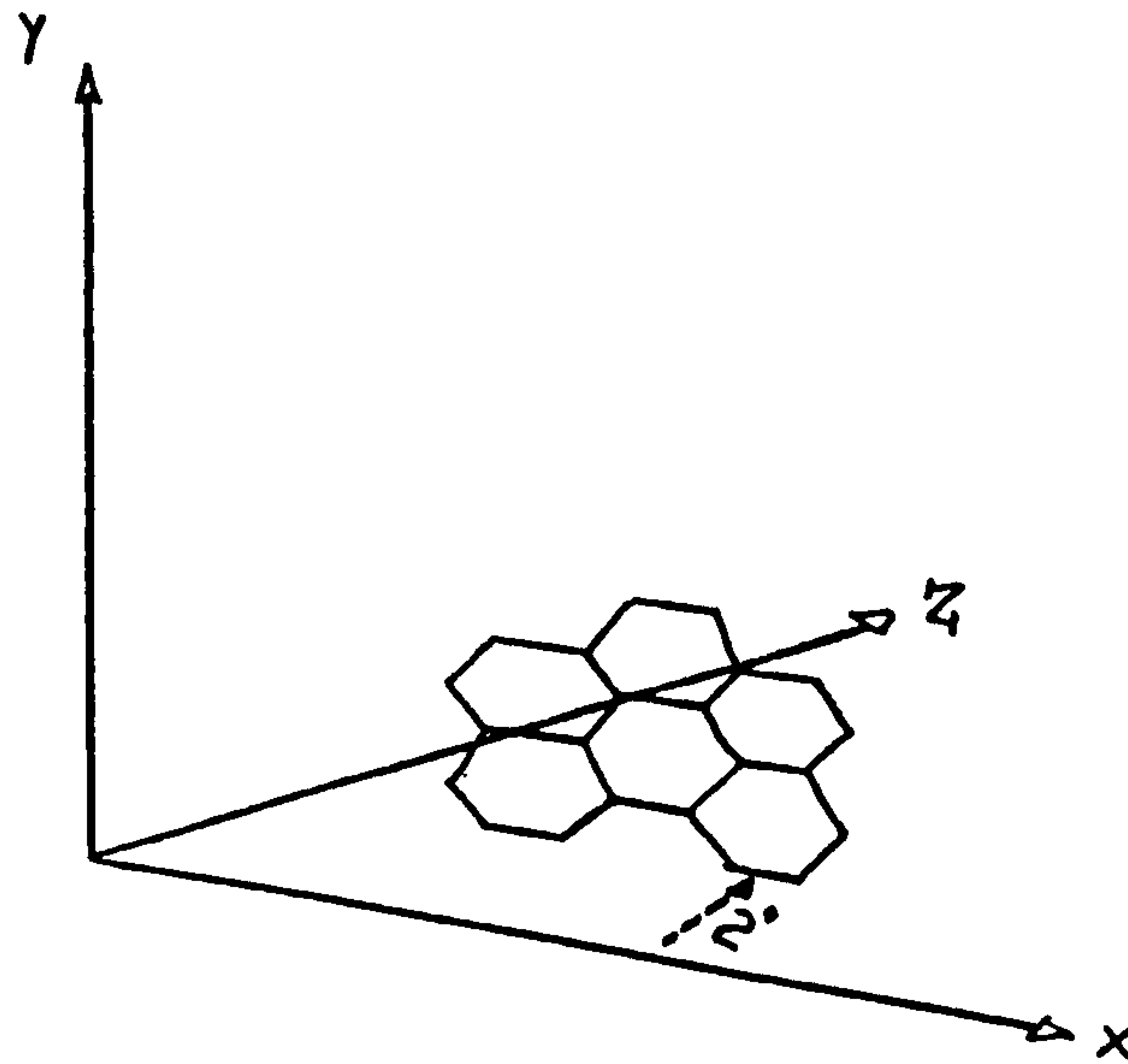

NOTES 1. The position of the eye must be specified by a call on eye or fishi

NAME FINISH

FUNCTION Enables plotting to be completed and moves the pen beyond the drawing to prevent it being overdrawn by the next program

ARGUMENTS (X)  
X (Real inches) is the distance moved by the pen after completing the drawing

EXAMPLE *CALL FINISH(10.0)*  
Completes plotting and moves the pen 10.0" along the X-axis relative to the origin

NOTES 1. The distance moved is relative to the origin



NAME FISHI (Fish-eye)

FUNCTION Establishes the position of the eye and the radius of a wide-angle lens and the point under observation

ARGUMENTS (*XE, YE, ZE, X, Y, Z, RADIUS*)

*XE, YE, ZE* (Real inches) are the coordinates of the eye in 3-d space

*X, Y, Z* (Real inches) are the coordinates of the point in space the eye is looking towards

*RADIUS* (Real inches) is the radius of the lens

EXAMPLE *CALL FISHI(0.0,0.0,0.0,0.0,5.0,10.0,1.0)*

This statement places the eye and a wide-angle lens of radius 1.0" at the origin and points it towards the point specified

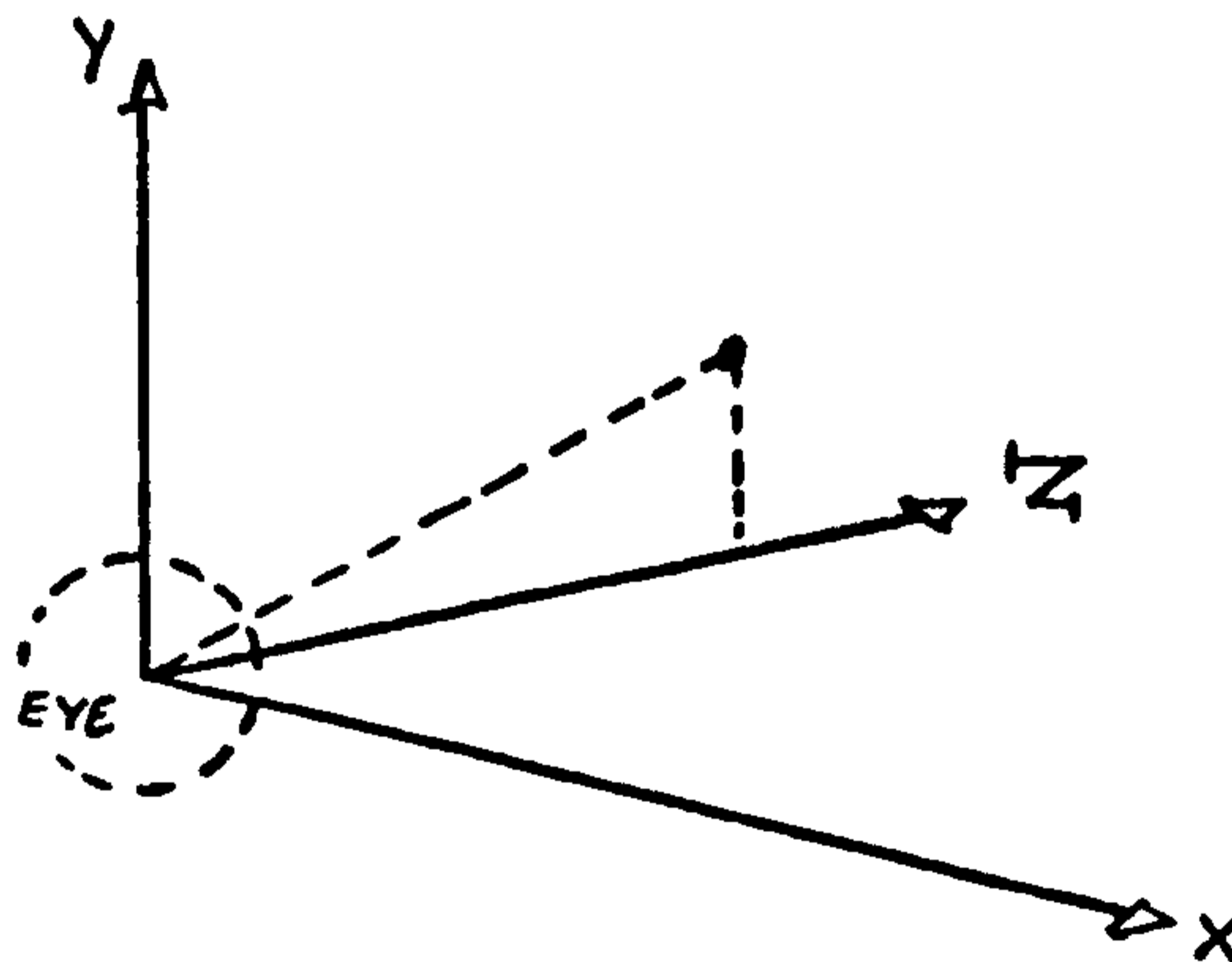

- NOTES
1. Fishi must be called to establish the wide-angle lens
  2. The picture plane is set 10.0" from the eye
  3. Fishi may be called many times
  4. The point the eye is looking towards is centered on the origin

NAME GRID

FUNCTION Plots out a regular grid of 2-dimensional shapes

ARGUMENTS (*ARRAY, SIZE, NX, XSP, NY, YSP, X, Y*)

*ARRAY* (Real array) stores a 2-d shape

*SIZE* (Real) is the degree of enlargement or reduction of the drawn shape relative to the original stored in array

*NX* (Integer) is the number of shapes to be drawn in the X-direction

*XSP* (Real inches) is the horizontal displacement between two shapes

*NY* (Integer) is the number of shapes to be drawn in the Y-direction

*YSP* (Real inches) is the vertical displacement between two shapes

*X, Y* (Real inches) is the amount of shift applied to the grid of shapes

EXAMPLE *CALL GRID(SQUARE, 1.0, 3, 1.2, 2, 1.2, 0.0, 0.0)*

Draws out the shape stored in *Square* 6 times at the original size in a grid format 3 by 2. The entire grid is displaced zero inches from the origin.

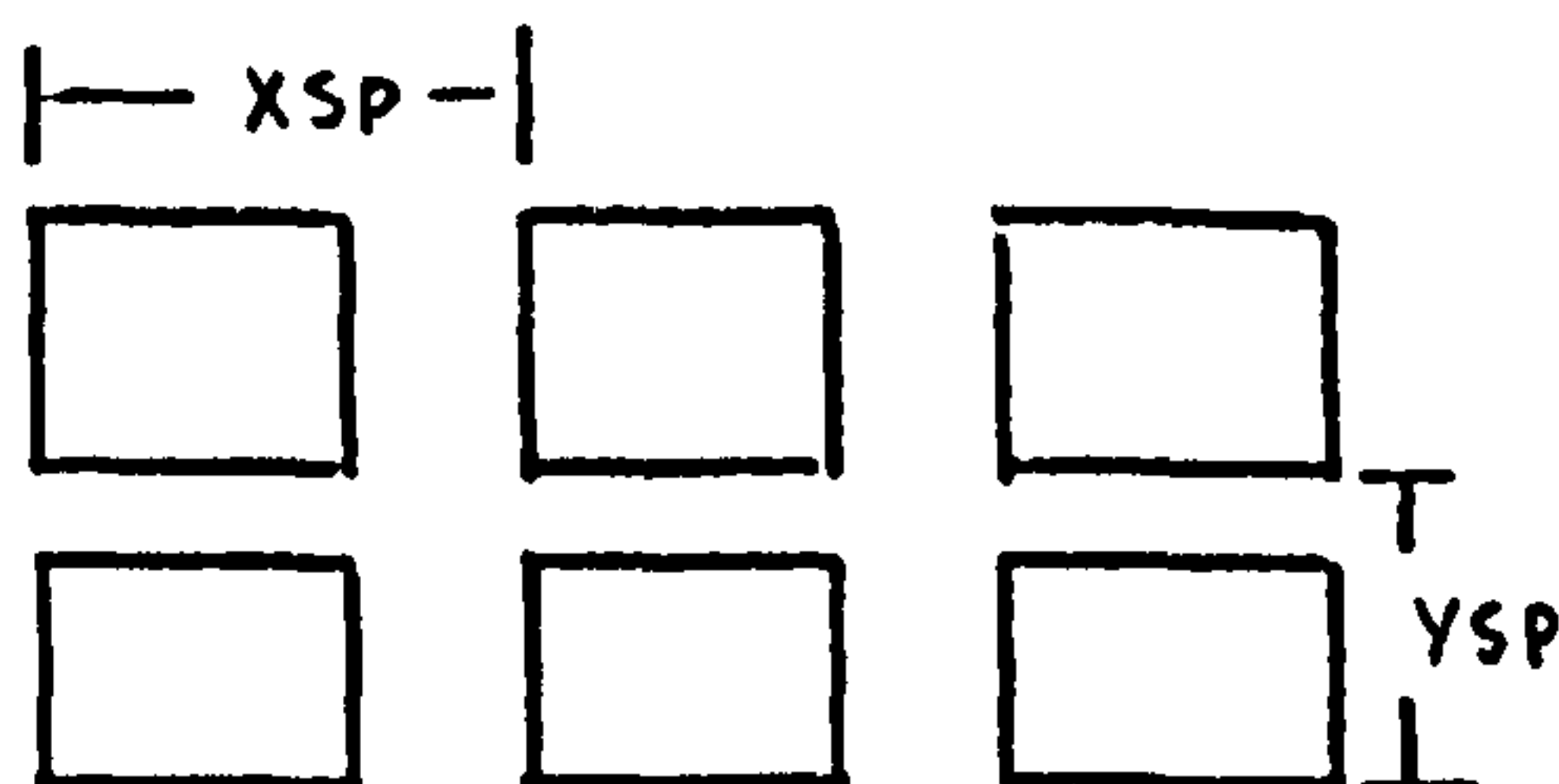

NOTES 1. Observe that XSP and YSP are not distances between two shapes, but are distances between the same point on displaced shapes

NAME FIT

FUNCTION Adjusts a 2-d *Picaso* open contour such that the end points are located at specific positions in space

ARGUMENTS (*ARRAY, X1, Y1, X2, Y2, F, ARRAYA*)

*ARRAY* (Real array) stores the 2-d *Picaso* contour

*X1, Y1* (Real inches) are the coordinates of the first point

*X2, Y2* (Real inches) are the coordinates of the second point

*F* (Real) is a multiplication factor effecting the amplitude of the contour

*ARRAYA* (Real array) stores the adjusted contour

EXAMPLE *CALL FIT(A, 0.0, 0.0, 1.0, 1.0, 1.0, A)*

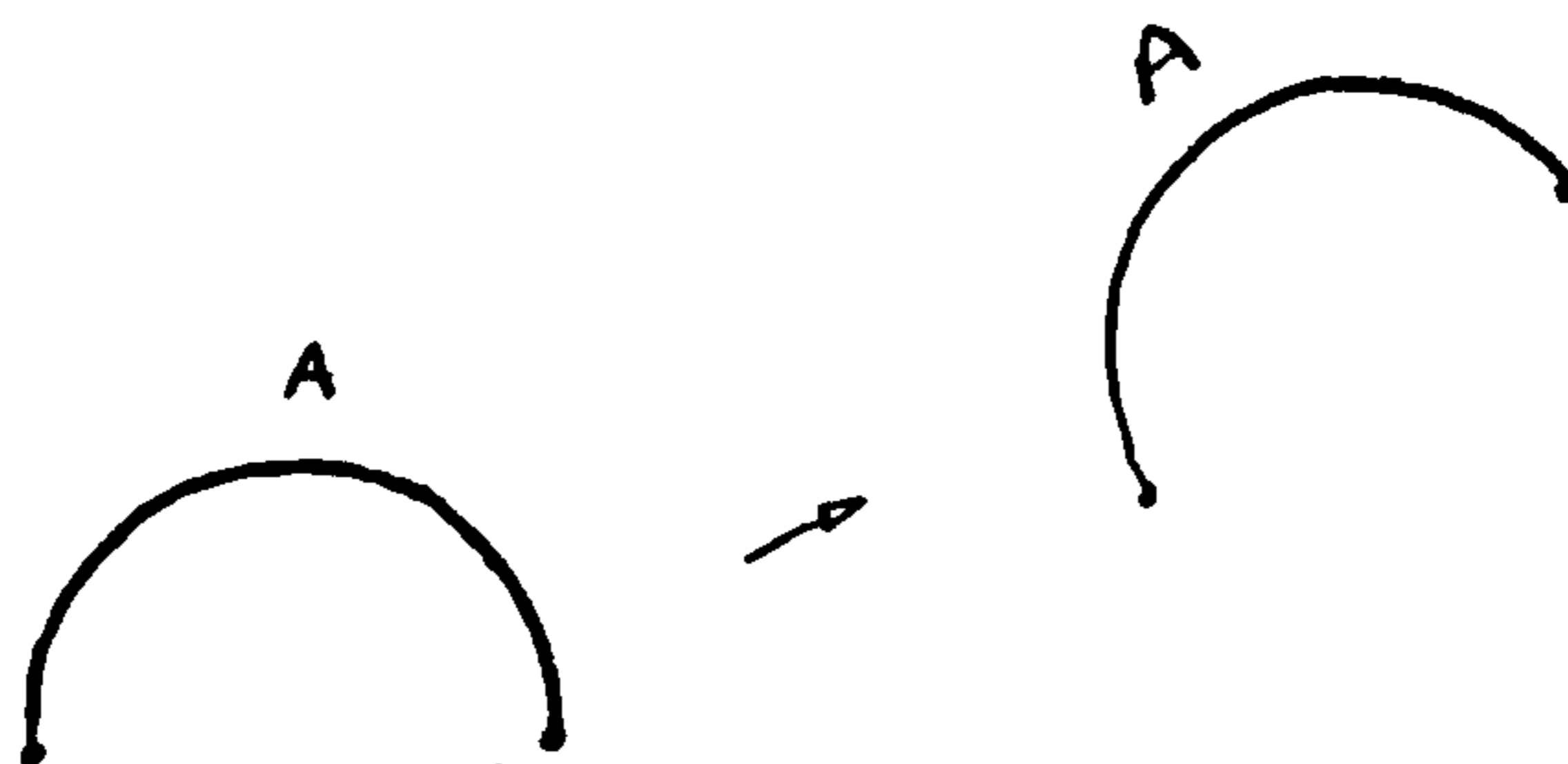

This statement takes the curve stored in *A* and adjusts the coordinates such the 1st and last coincide with the origin and *1.0, 1.0*.

NOTES 1. No plotting takes place

**NAME** GRID2D (Draw a 2-d grid in 3-d)

**FUNCTION** Draws out a three-dimensional version of a 2-d *Picasso* grid

**ARGUMENTS** (*ARRAY, SIZE, X, Y, NX, XSP, NY, YSP, N1, N2, N3, V*)

*ARRAY* (Real array) stores a 2-d *Picasso* shape

*SIZE* (Real) alters the size of the final drawing by 'size' times

*X, Y* (Real inches) is the degree of shift applied to the 2-d grid

*NX* (Integer) is the number of shapes in the 'x' direction

*XSP* (Real inches) is the distance between points on two shapes in the 'x' direction

*NY* (Integer) is the number of shapes in the 'y' direction

*YSP* (Real inches) is the distance between points on two shapes in the 'y' direction

*N1, N2, N3* (Integer) determine the transformation

<i>N1</i>	<i>N2</i>	<i>N3</i>	<i>X</i>	<i>Y</i>	<i>Z</i>	IN 3-D
1	2	3	X	Y	V	
1	3	2	X	V	Y	
2	1	3	Y	X	V	
3	1	2	V	X	Y	IN 2-D
2	3	1	Y	V	X	
3	2	1	V	Y	X	

*V* (Real) is the value for the third dimension

**EXAMPLE** *CALL GRID2D(SQ, 1.0, 0.0, 0.0, 4, 1.0, 3, 1.0, 1, 3, 2, 1.0)*  
 This statement produces the following transposition

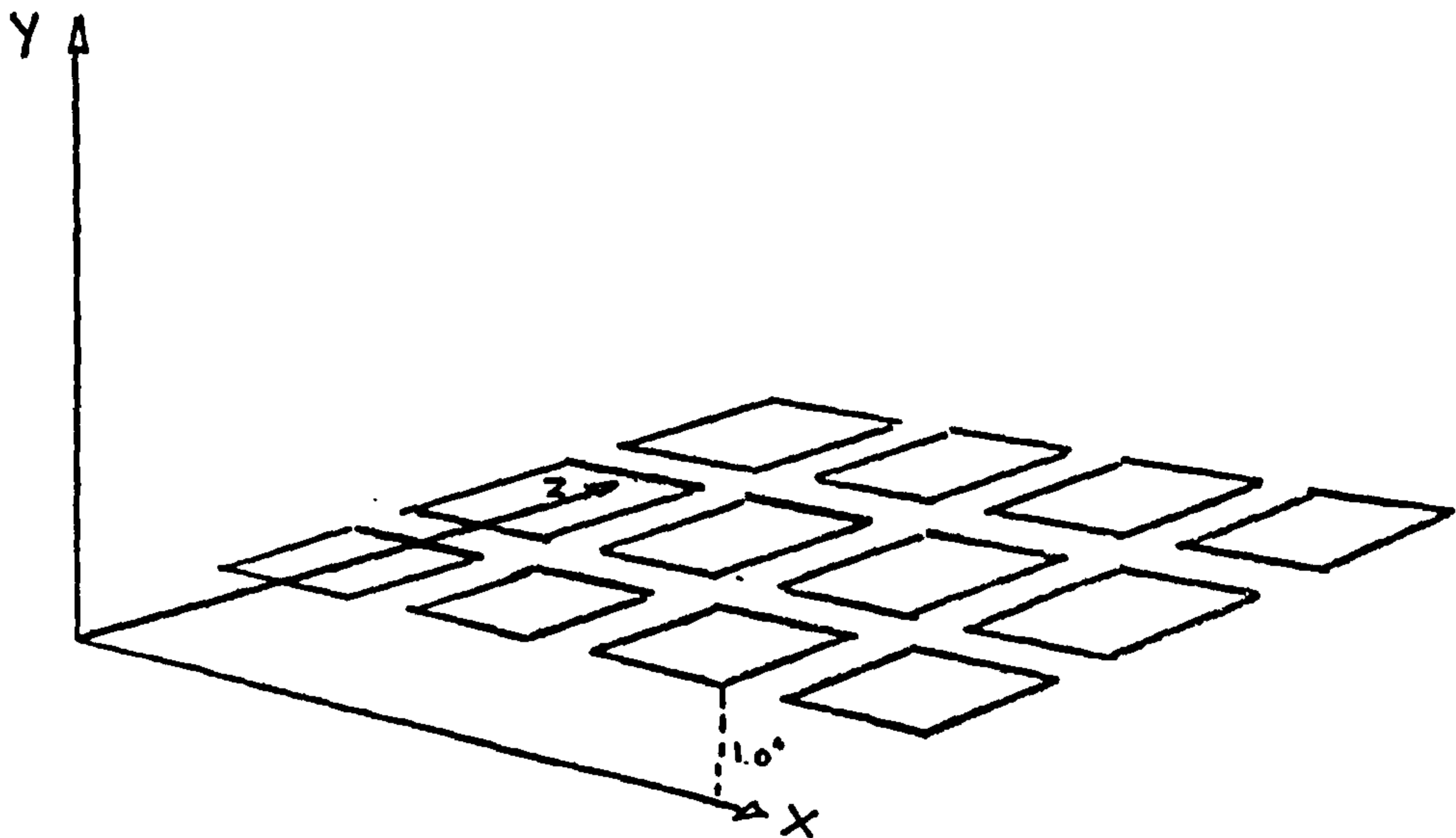

## NOTES

1. The position of the eye must be specified by a call on eye or fishi.

NAME        GROW (Recursive growth)

FUNCTION    Draws out a recursive growth pattern using vertices of any shape as the centre of growth for more shapes

ARGUMENTS  (*ARRAY, SIZE, X, Y, N, STACK*)

*ARRAY*     (Real array) stores a 2-d *Picasso* shape

*SIZE*      (Real) alters the size of the final drawing by 'size' times

*X, Y*      (Real inches) is the degree of shift applied to the entire structure

*N*         (Integer) is the depth of growth

*STACK*    (Real array) is an array supplied to grow to enable the recursive growth to be computed

EXAMPLE    *CALL GROW(HEX, 0.0, 0.0, 3, STACK)*

This statement produces the following output assuming that *hex* contains a regular hexagon

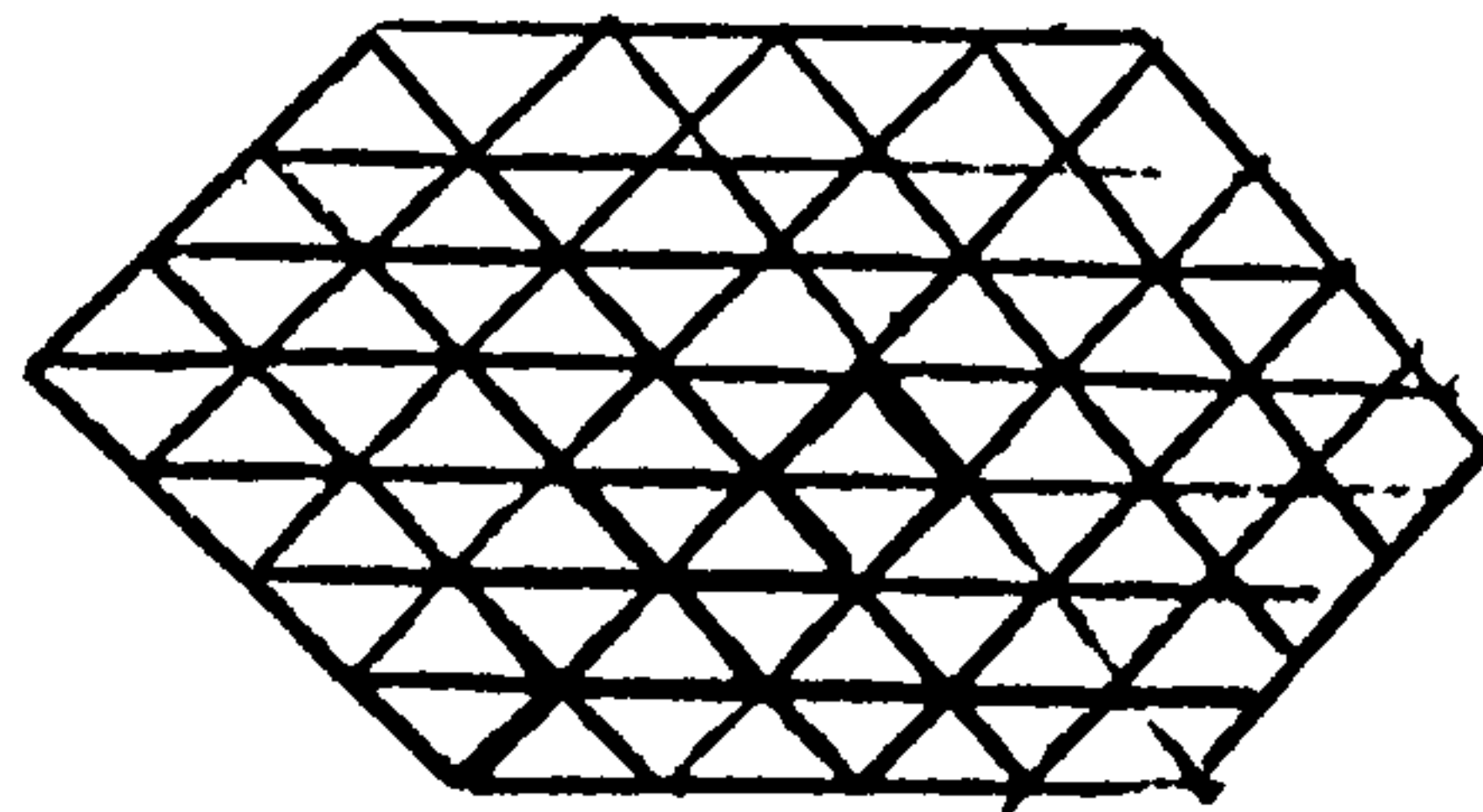

NOTES      1. The array stack must be dimension

            3\*DEPTH\*N<sub>V</sub>

            where N<sub>V</sub> is the number of vertices in the shape

**NAME** GROW2D (Grow a 2-d shape in 3-d)

**FUNCTION** Draws out a recursive growth pattern using vertices of any shape as the centre of growth for more shapes in 3-d.

**ARGUMENTS** (*ARRAY, SIZE, X, Y, N, N1, N2, N3, V, STACK*)

*ARRAY* (Real array) stores a 2-d *Picasso* shape

*SIZE* (Real) alters the size of the final shape

*X, Y* (Real) is the degree of shift applied to the 2-d shape

*N* (Integer) is the depth of growth

*N1, N2, N3* (Integer) determine the transposition (see *grow*)

*V* (Real) is the value for the third dimension

*STACK* (Real array) is a work array required by *Grow2d* and is dimensioned:  
 $STACK(3*N*N_V)$  where  $N_V$  is the number of vertices in array

**EXAMPLE** `CALL GROW2D(A, 1.0, 0.0, 0.0, 3, 1, 3, 2, 1.0, STACK)`

This statement allows the shape in 'A' to grow to a depth of 3 one inch above the X,Z plane

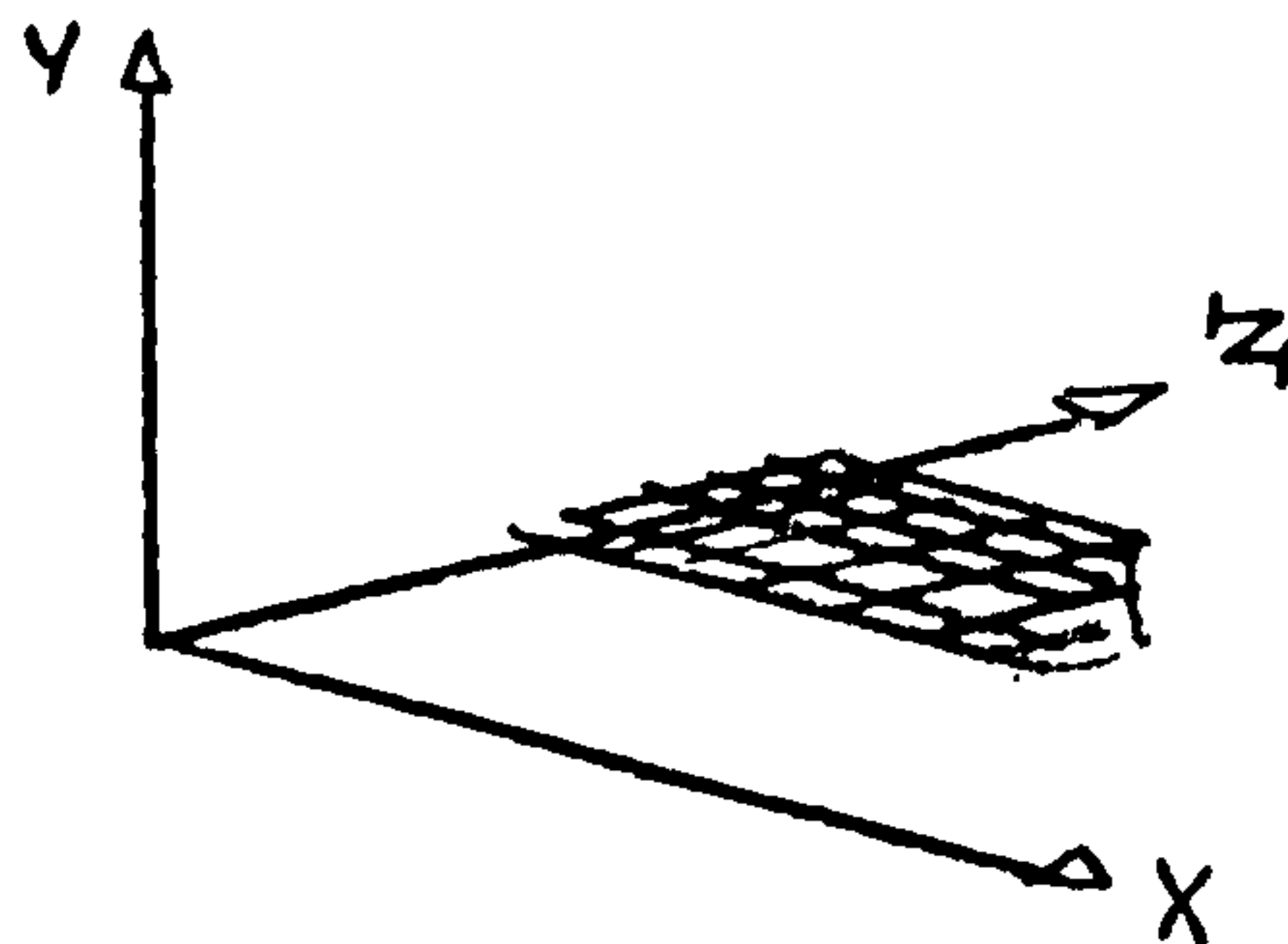

**NOTES** 1. The position of the eye must be specified by calling *eye* or *fishi*

NAME HATCH

FUNCTION Hatches a 2-d *Picaso* shape with parallel lines

ARGUMENTS (*ARRAY, THETA, SPACE*)

*ARRAY* (Real array) stores a 2-d *Picaso* shape

*THETA* (Real degrees) is the angle of the lines

*SPACE* (Real inches) is the distance between lines

EXAMPLE *CALL HATCH(A, 45.0, 0.1)*

This statement draws parallel lines at  $45^{\circ}$   
 $0.1''$  apart over the shape stored in

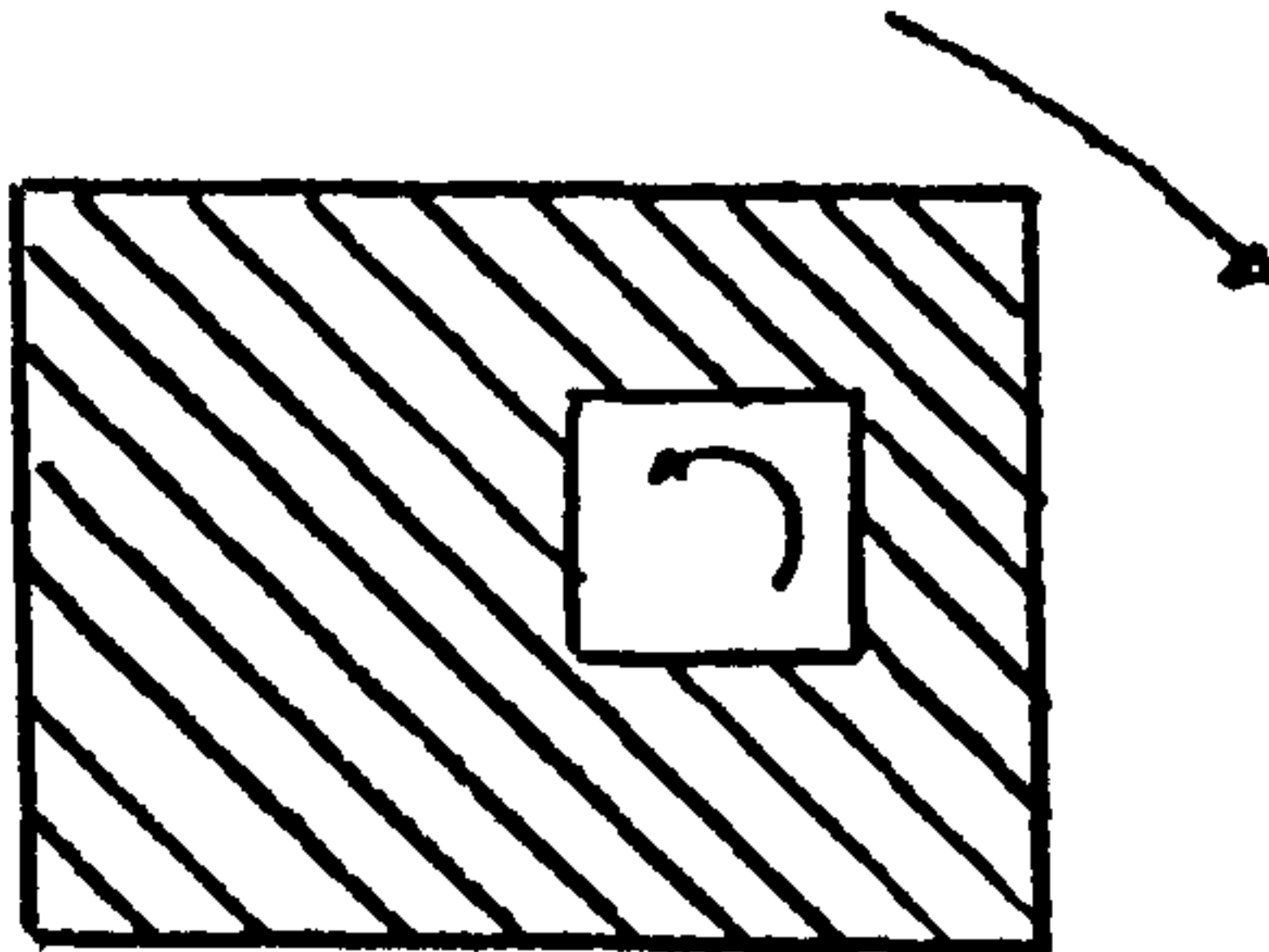

NOTES 1. Clockwise contours create a shape, holes are created by anti-clockwise contours



## PICASO SYSTEM

HIDE

NAME HIDE

FUNCTION Draws out the contents of an array depending upon the contents of two arrays storing upper and lower contours

ARGUMENTS (*ARRAY, OVER, UNDER, N, NLINE, WIDTH, DIST, XS, YS*)

*ARRAY* (Real array) stores a 2-d *Picasso* contour

*OVER* (Real array) is used by hide to maintain the upper contour

*UNDER* (Real array) is used by hide to maintain the lower contour

*N* (Integer) is the number of elements in the array (also over & under)

*NLINES* (Integer) is the number of the line being drawn

*WIDTH* (Real inches) is the length of the line

*DIST* (Real inches) is the distance between lines

*XS, YS* (Real inches) is the degree of shift applied to the line

EXAMPLE *CALL HIDE(ARRAY, OVER, UNDER, 3, 20, 5.0, 0.1, 0.0, 0.0)*

This statement could produce the output shown below

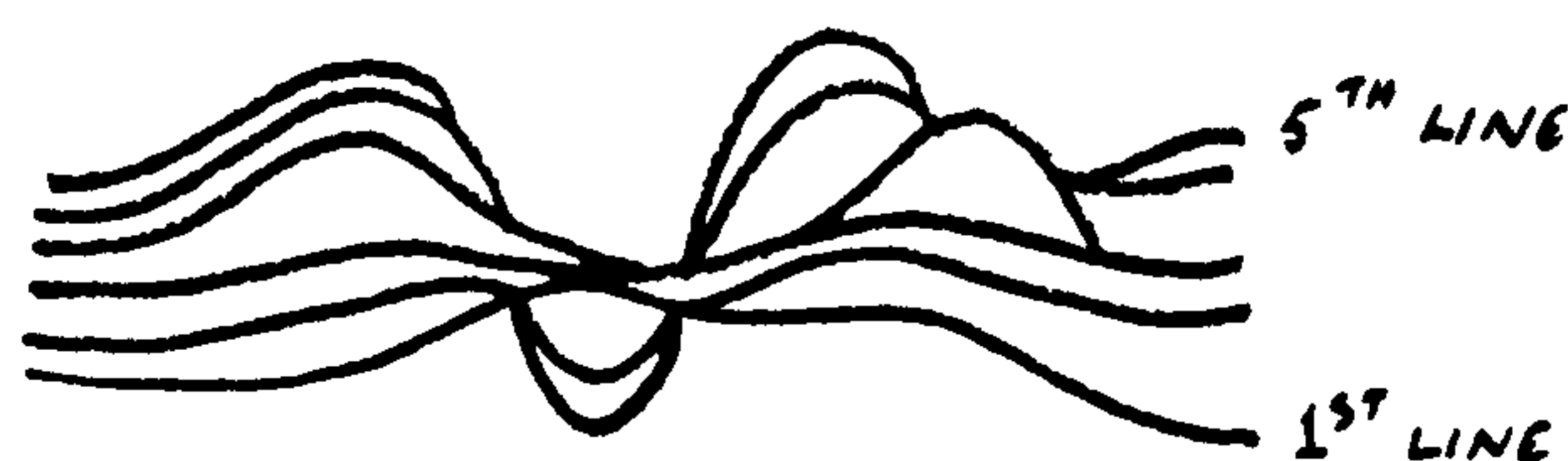

NOTES 1. Array, over & under must be dimensioned

NAME HULL (Ractangular Hull)

FUNCTION Determines the minimum and maximum X and Y values of a 2-dimensional *Picasso* shape

ARGUMENTS (*ARRAY, XMIN, XMAX, YMIN, YMAX*)

*ARRAY* (Real array) stores 2-d *Picasso* shape

*XMIN* (Real inches) minimum X coordinate

*XMAX* (Real inches) maximum Y coordinate

*YMIN* (Real inches) minimum Y coordinate

*YMAX* (Real inches) maximum Y coordinate

EXAMPLE *CALL HULL(BOX, XMIN, XMAX, YMIN, YMAX)*

This statement returns values of *XMIN, XMAX, YMIN & YMAX* for the shape stored in *Box*

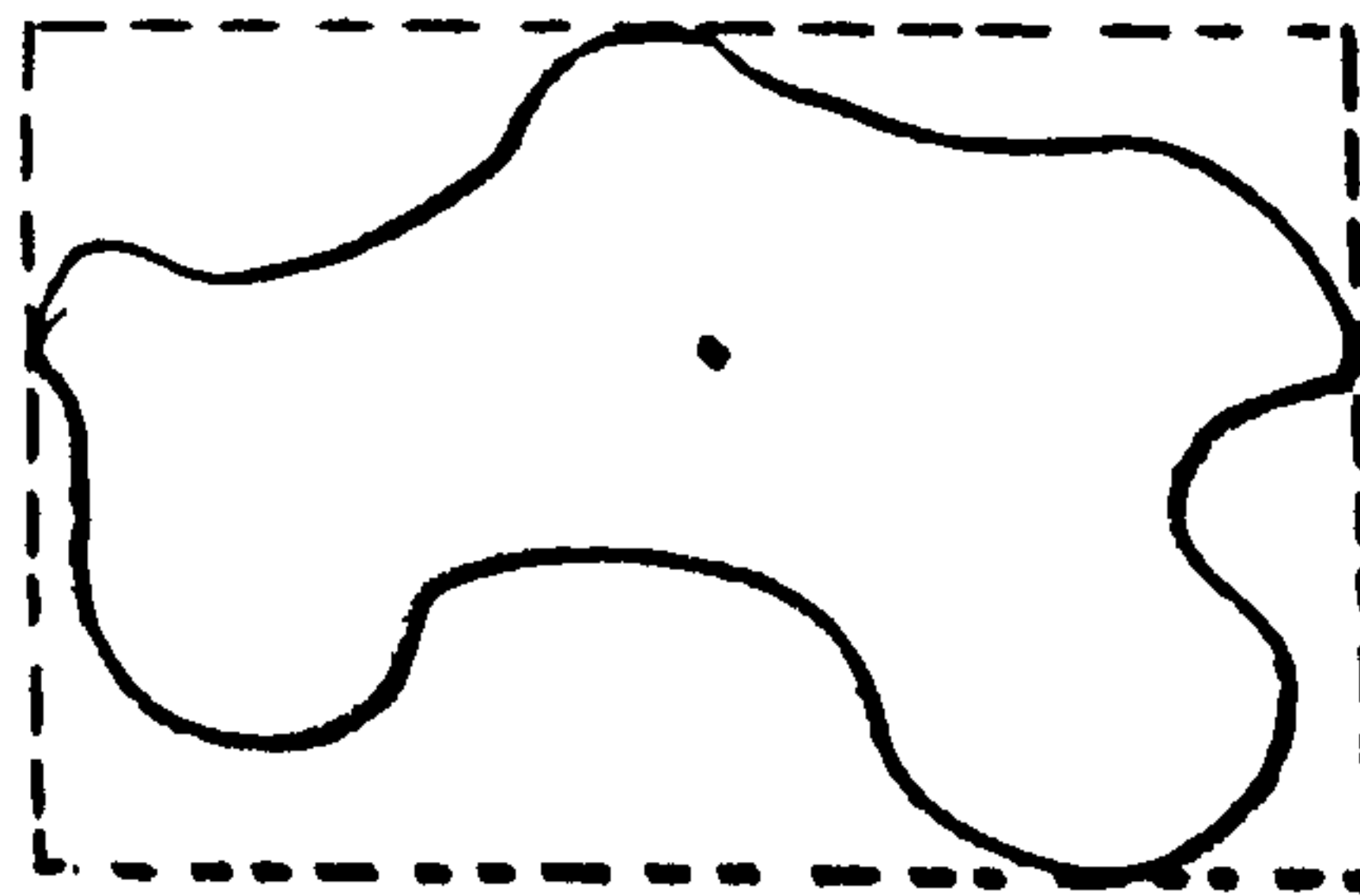

NOTES 1. No plotting takes place

NAME        HYPERB (Hyperbola)

FUNCTION    Stores a Hyperbola in array

ARGUMENTS  (*ARRAY, SPAN, DIST, N*)

*ARRAY*    (Real array) stores the hyperbola

*SPAN*     (Real inches) is the width and height of the  
          curve

*DIST*     (Real inches) is the distance of the curve  
          from the X or Y axis at the limits of the  
          curve

*N*        (Integer) is the number of points in the  
          curve

EXAMPLE    *CALL HYPERB(H, 2.0, 0.5, 10)*

          This statement stores a hyperbola in *H* 2.0  
          by 2.0 inches, 0.5 inches from the origin  
          axes

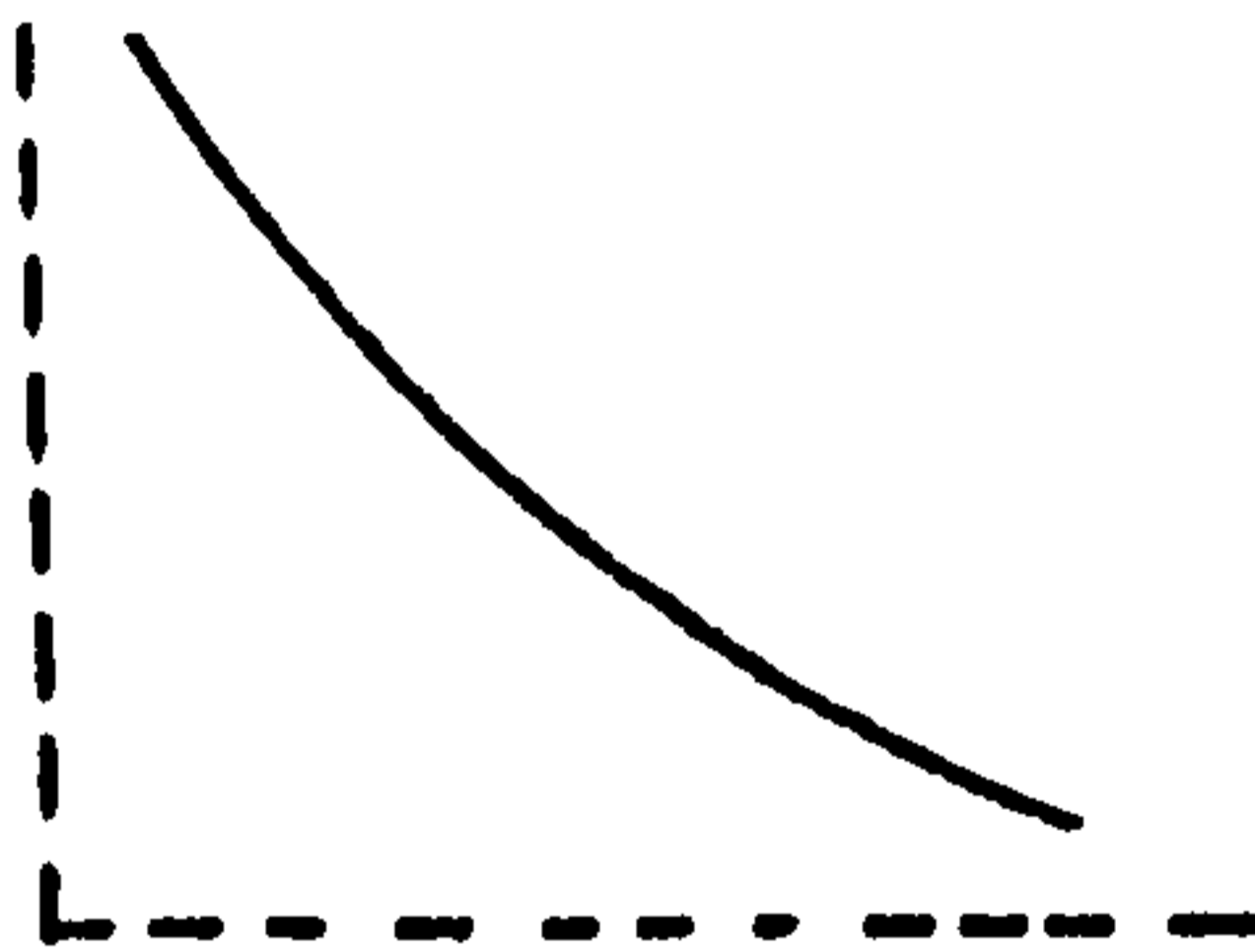

NOTES      1. No plotting takes place

NAME HYPOTR (Hypotrochoid)

FUNCTION Stores a Hypotrochoid curve as a 2-d *Picasso* shape

ARGUMENTS (*ARRAY, RADFIX, RADMOV, DIST, N*)

*ARRAY* (Real array) stores the 2-d hypotrochoid

*RADFIX* (Real inches) is the radius of the fixed circle

*RADMOV* (Real inches) is the radius of the moving circle

*DIST* (Real inches) is the distance of the traced point that exists on the moving circle to its centre

*N* (Integer) is the number of points on the curve

EXAMPLE *CALL HYPOTR(H, 2.0, 1.0, 1.0, 60)*

This statement represents a 1.0" radius circle moving inside a fixed 2.0" radius circle. The point traced is 1.0" from the centre.

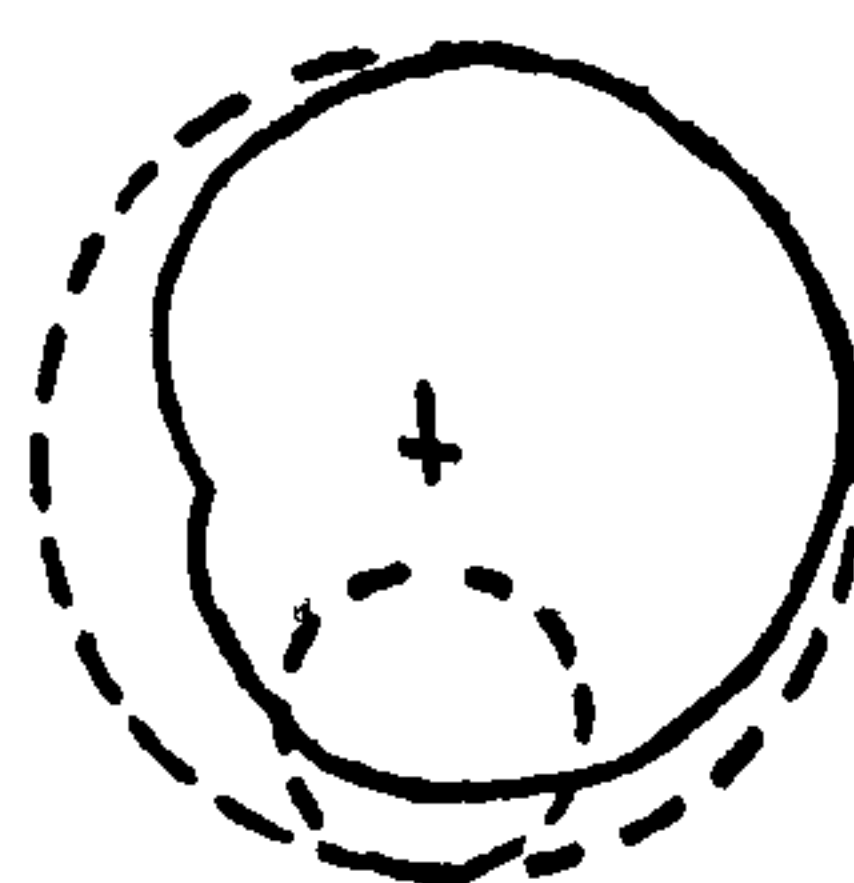

NOTES 1. No plotting takes place

PICASO SYSTEM

INSIDE

NAME           INSIDE

FUNCTION       Determines whether the point X,Y is in or outside  
a shape

ARGUMENTS     (*ARRAY*,*X*,*Y*)

*ARRAY*       (Real array) stores a 2-d *Picasso* shape  
*X*,*Y*         (Real inches) references the point to be  
tested

EXAMPLE       *J=INSIDE(BOX,0.0,1.0)*

This statement sets *J=.TRUE.* If the point  
(0.0,1.0) is inside the shape stored in *box*  
else *J=.FALSE.*

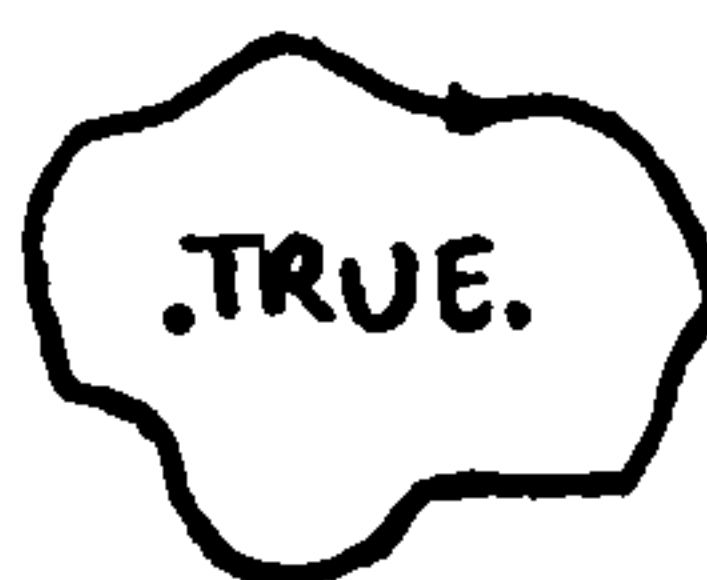

.FALSE.

NOTES          1. A clockwise contour creates a surface whilst an  
anti-clockwise contour creates a hole

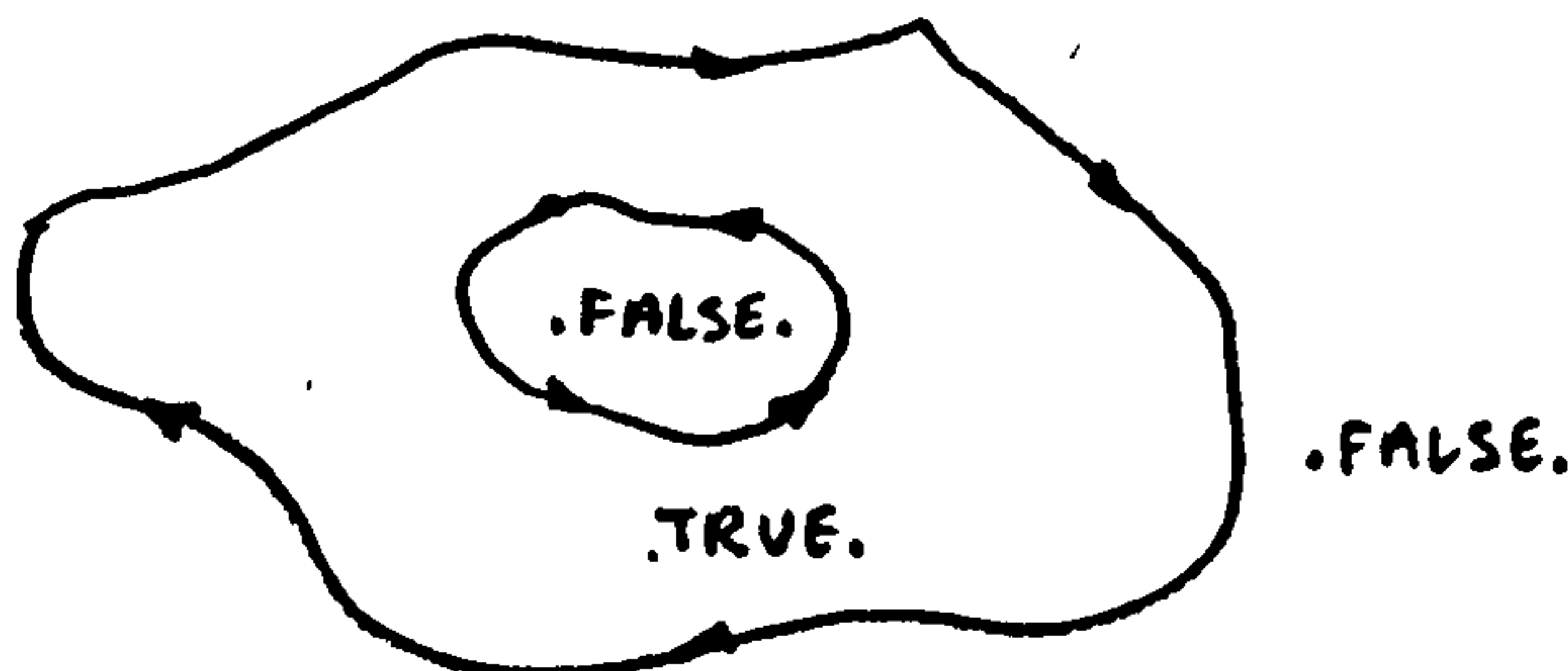

2. Inside is a logical function

NAME        IRRAY1 (Integer one dimension array)

FUNCTION    Reads in punched card data and stores it in a one-  
             dimension array

ARGUMENTS  (*ARRAY, COL*)

*ARRAY*    (Integer array) is the name of the array

*COL*        (Integer) is the number of columns in the  
                         array

EXAMPLE    *CALL IRRAY1(K, 21)*

             This statement reads in sufficient cards to  
             store 21 numbers in K.

NOTES       1. The format of the cards is (10I8) the numbers must  
             be right-justified

             2. For the above example 3 cards are required:

**NAME**            IRRAY2 (Integer two dimension array)

**FUNCTION**      Reads in punched card data and stores it in a two  
                  dimension array

**ARGUMENTS**    (*ARRAY, COL, ROW*)

*ARRAY*          (Integer array) is the name of the array

*COL*            (Integer) is the number of columns in the  
                  array

*ROW*            (Integer) is the number of rows in the array

**EXAMPLE**      *CALL IRRAY2(K, 21, 2)*

                  This statement reads in sufficient cards to  
                  store 42 numbers in *K*.

**NOTES**        1. The format of the cards is (10I8) the numbers must  
                  be right-justified

                  2. For the above example 6 cards are required:

**NAME** ISOMET (Isometric surface)

**FUNCTION** Draws an isometric projection of a tiled surface created by rotating a 2-d contour about an axis

**ARGUMENTS** (*ARRAY, LX, NX, LY, NY, ANGLE, XC, YC, WARRAY, SOLID, OVER, UNDER, XS, YS, V*)

*ARRAY* (Real array) stores a 2-d open *Picasa* contour

*LX* (Real inches) is the width of the surface

*NX* (Integer) is the number of points across the surface

*LY* (Real inches) is the depth of the surface

*NY* (Integer) is the number of points in the depth of the surface

*ANGLE* (Real degrees) is the angle the surface makes with the X-Z plane

*XC, YC* (Real inches) are the coordinates of the axis about which rotation occurs

*WARRAY* (Real array) is a work array required by isomet and is dimensioned (2, NX+NY)

*SOLID* (Integer array) is a work array required by isomet and is dimensioned (NX+NY)

*OVER* (Real array) is a work array required to store the upper horizon and is dimensioned (NX+NY)

*UNDER* (Real array) is a work array required by isomet to store the lower horizon and is dimensioned (NX+NY)

*XS, YS* (Real inches) are the coordinates of the nearest corner relative to the origin

*V* (Real inches) is the height of the surface beyond the range of the contour



EXAMPLE `CALL ISOMET(A,6.0,20,6.0,20,30.0,3.0,3.0,W;S,0,U,0.0,0.0,0.0)`

This statement produces an isometric projection of a surface produced by rotating the contour stored in *A* about the point 3.0,3.0.

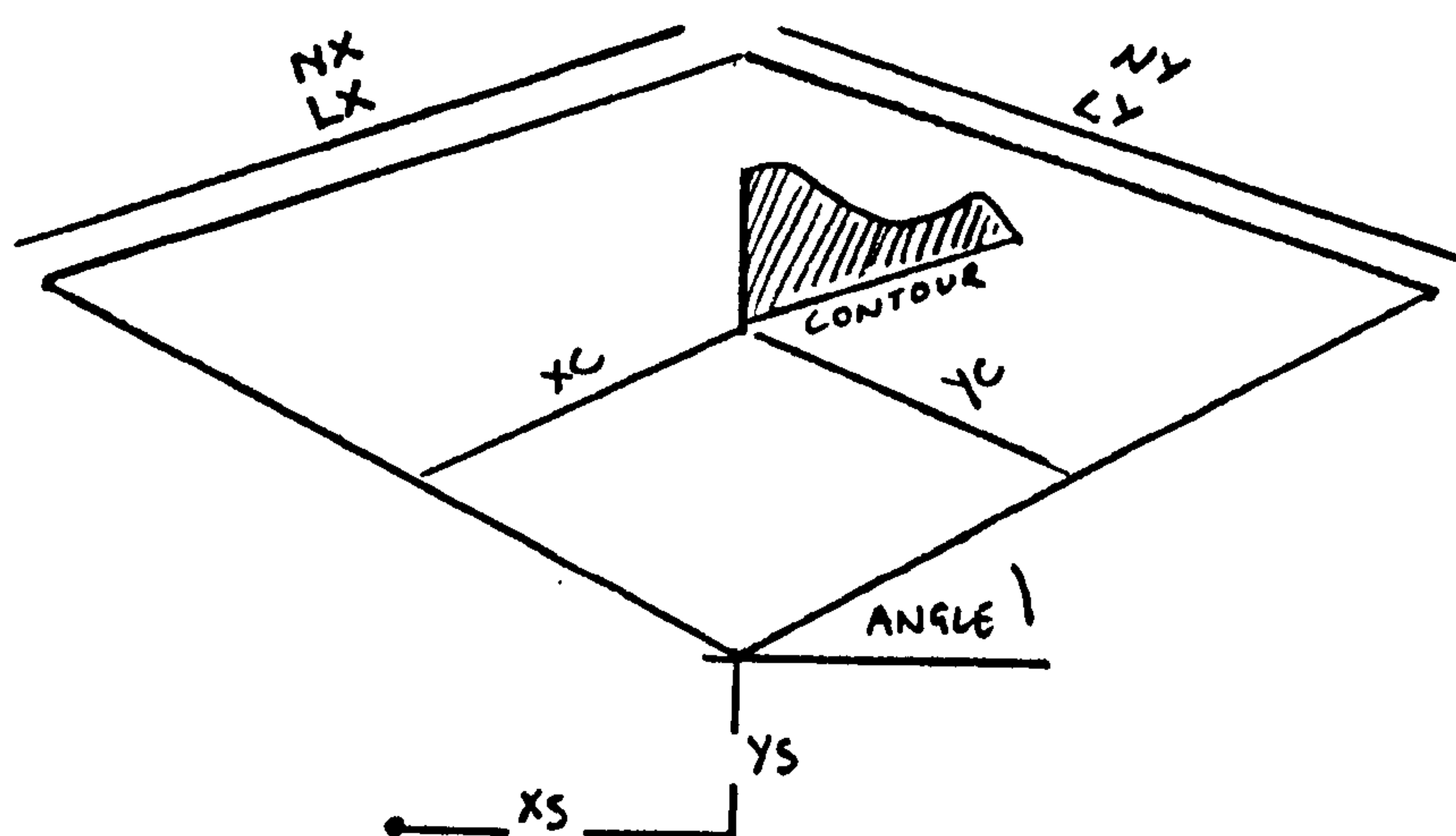
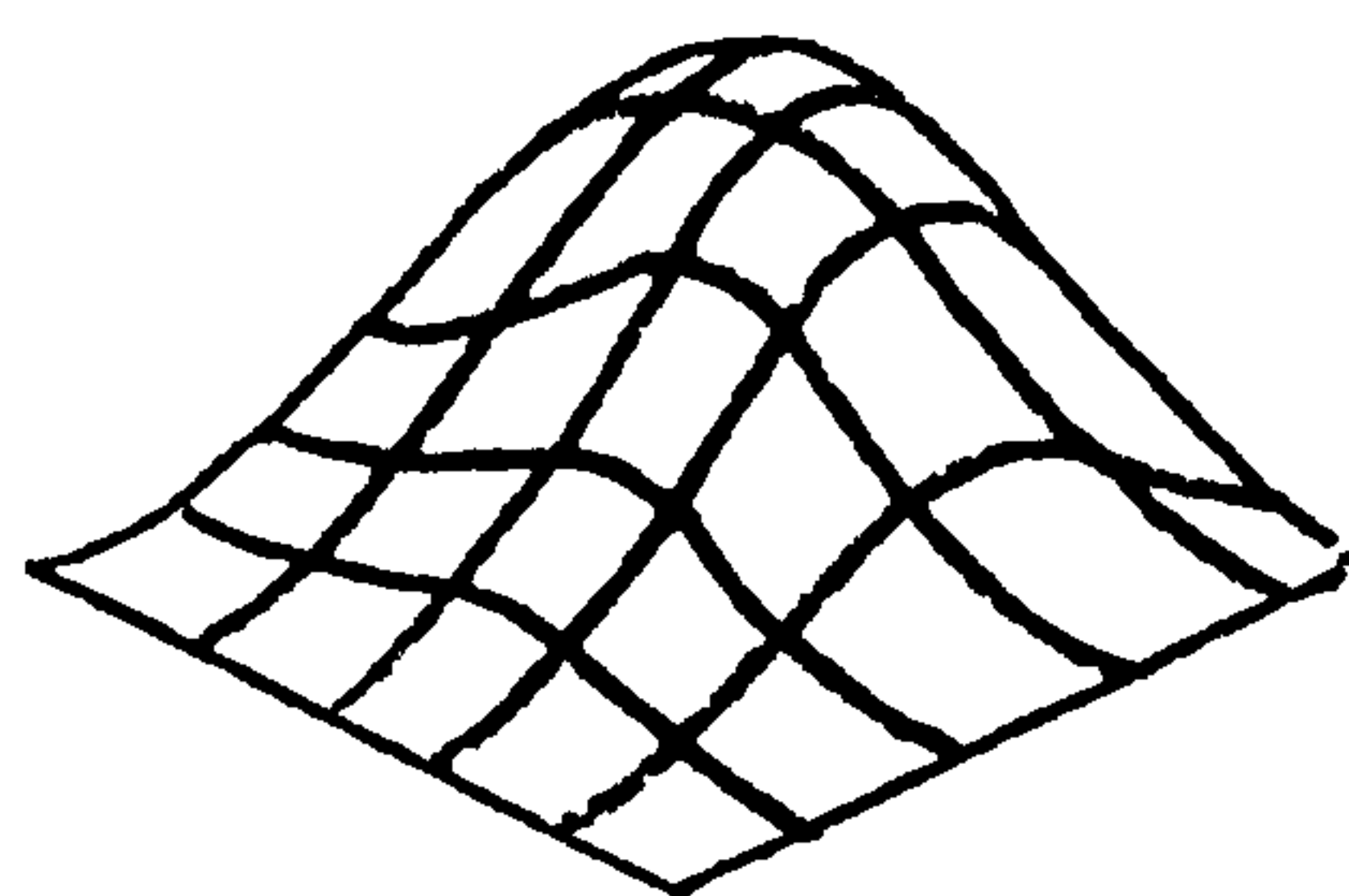

NAME       ITAKE (Integer take)

FUNCTION   Selects an integer random number from a specified  
           range

ARGUMENTS  (*I,J*)

*I*       (Integer) defines low-order range

*J*       (Integer) defines high-order range

EXAMPLE    *K=ITAKE(-3,2)*

           This statement selects a random number  
           between the range -3 to 2 inclusive

NAME JOIN

FUNCTION Joins together two *Picasso* structures

ARGUMENTS (*ARRAYA*,*ARRAYB*)

*ARRAYA* (Real array) stores a *Picasso* structure

*ARRAYB* (Real array) stores a *Picasso* structure and receives the shape stored in *arraya*

EXAMPLE *CALL JOIN(A,B)*

This statement copies across the structure stored in 'A' and stores it behind 'B',

NOTES 1. Join may be used for 2 or 3 dimensioned structures

NAME        LINE

FUNCTION   Stores a line   in array

ARGUMENTS  (*ARRAY, X1, Y1, X2, Y2, N*)

*ARRAY*     (Real array) stores the line

*X1, Y1*    (Real inches) are the coordinates of one end  
of the line

*X2, Y2*    (Real inches) are the coordinates of the  
other end of the line

*N*         (Integer) is the number of points on the line

EXAMPLE    *CALL LINE(A, 0.0, 0.0, 1.0, 1.0, 5)*

This statement stores a line in *A* between the  
origin and 1.0, 1.0 in 5 points

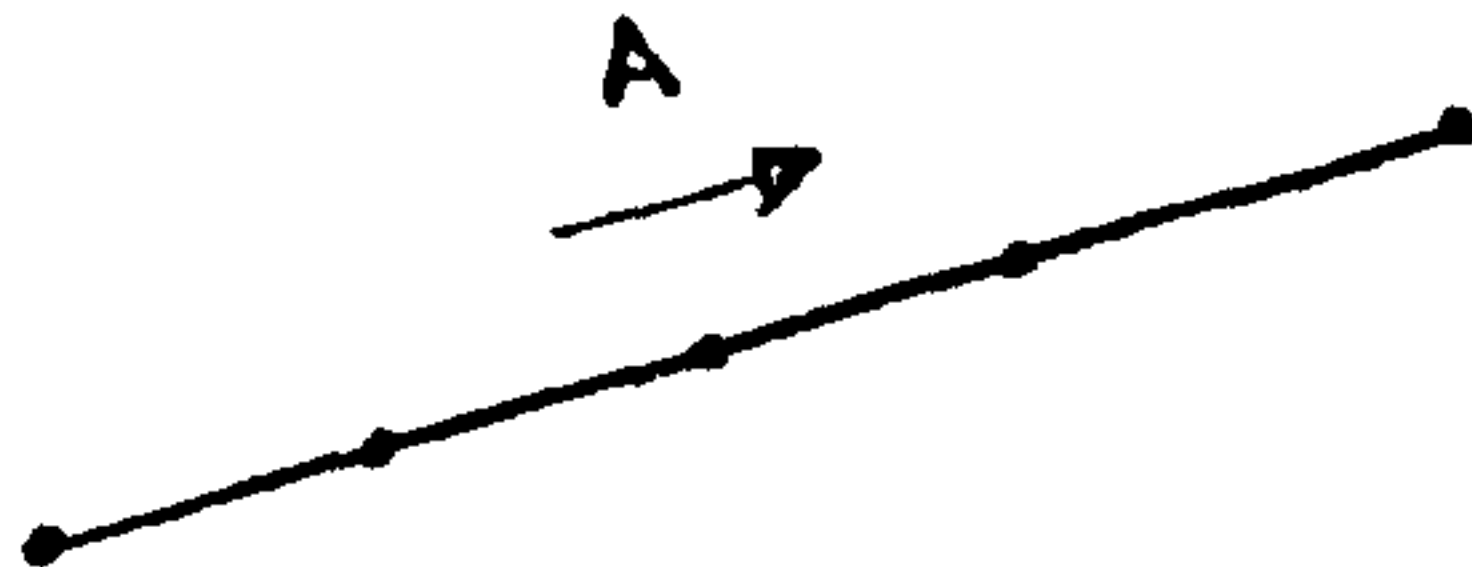

NOTES       1. No plotting takes place

NAME LINE3D (Line in 3-d)

FUNCTION Stores a three-dimensional line as a *Picaso* structure

ARGUMENTS (*ARRAY*, *X1*, *Y1*, *Z1*, *X2*, *Y2*, *Z2*)

*ARRAY* (Real array) stores the 3-d *Picaso* line  
*X1*, *Y1*, *Z1* (Real inches) references the first point  
*X2*, *Y2*, *Z2* (Real inches) references the second point

EXAMPLE `CALL LINE3D(A,0.0,0.0,0.0,1.0,1.0,1.0)`

This statement stores *A* line starting at the origin and finishing at  $X=Y=Z=1.0$ "

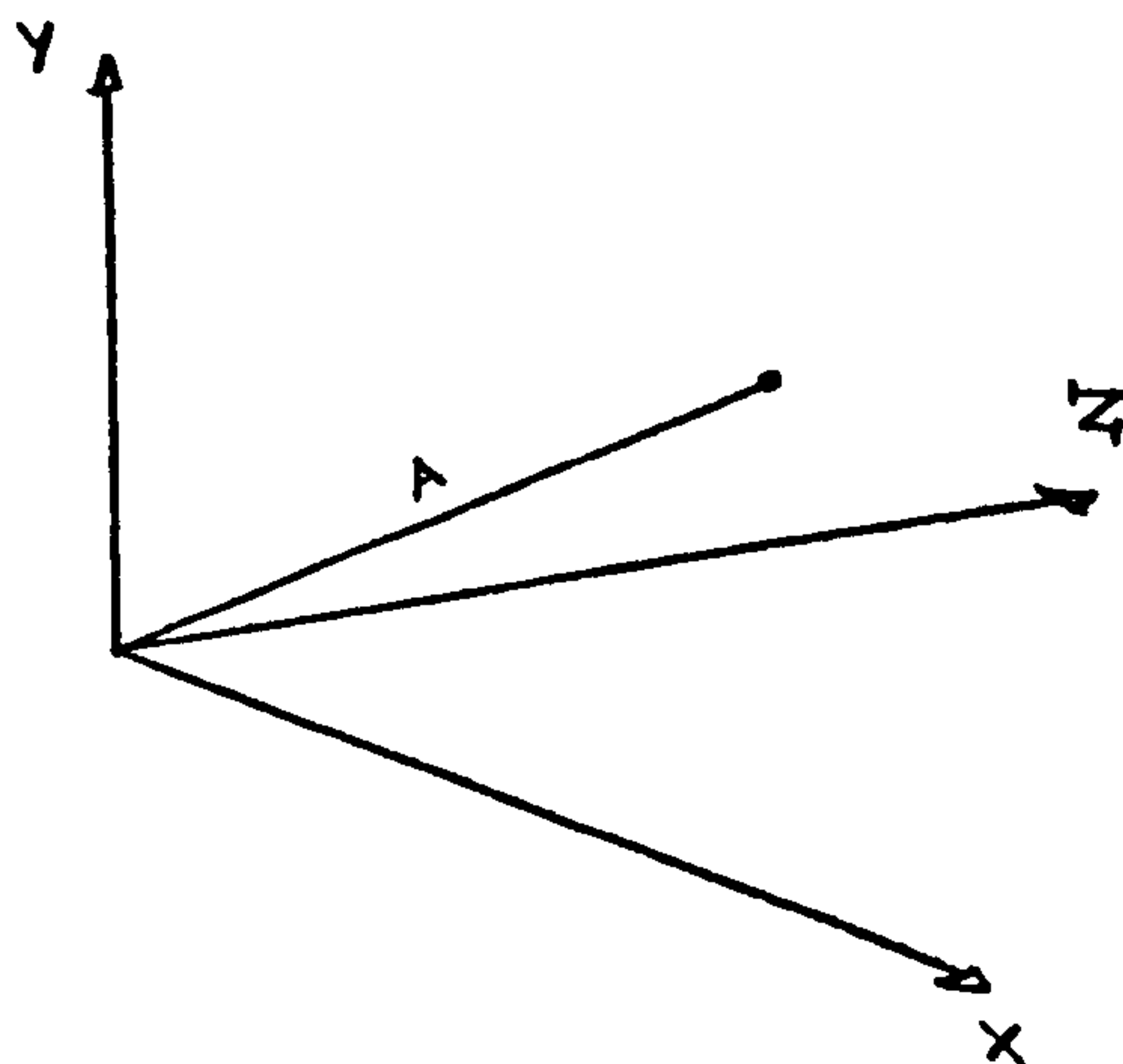

NOTES 1. No plotting takes place

NAME LISSAJ (Lissajous Curves)

FUNCTION Stores a lissajous figure in an array

ARGUMENTS (*ARRAY, XSPAN, YSPAN, F, D, N*)

*ARRAY* (Real array) stores the lissajous curve  
*XSPAN* (Real inches) is the width of the curve  
*YSPAN* (Real inches) is the height of the curve  
*F* (Real) is a factor affecting the number of loops in the 'X' direction  
*D* (Real radians) is a displacement value  
*N* (Integer) is the number of points in the curve

EXAMPLE *CALL LISSAJ(A, 2.0, 1.0, 1.0, 0.0, 100)*

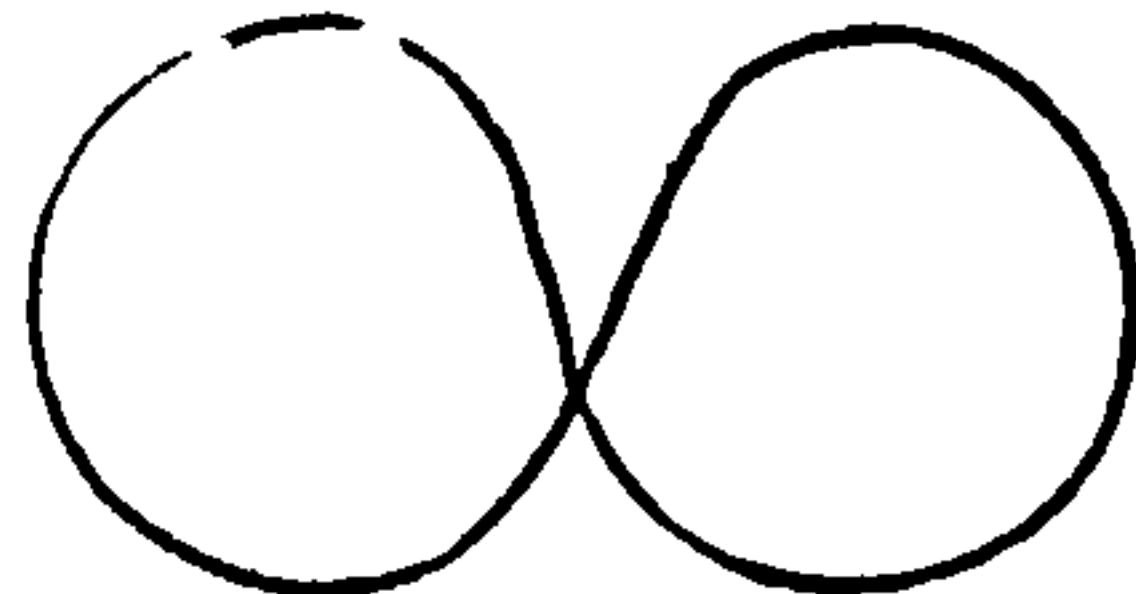

NOTES 1. No plotting takes place

NAME LSPIRA (Logarithmic Spiral)

FUNCTION Stores a logarithmic spiral in array

ARGUMENTS (*ARRAY, RADIUS, CYCLES, N*)

*ARRAY* (Real array) stores the spiral

*RADIUS* (Real inches) is the final radius after the specified number of revolutions

*CYCLES* (Real) is the number of revolutions

*N* (Integer) is the number of points in the curve

EXAMPLE *CALL LSPIRA(S, 3.0, 2.0, 60)*

This statement stores a logarithmic spiral in *S* with 2.0 revolutions, the final radius is 3.0 inches

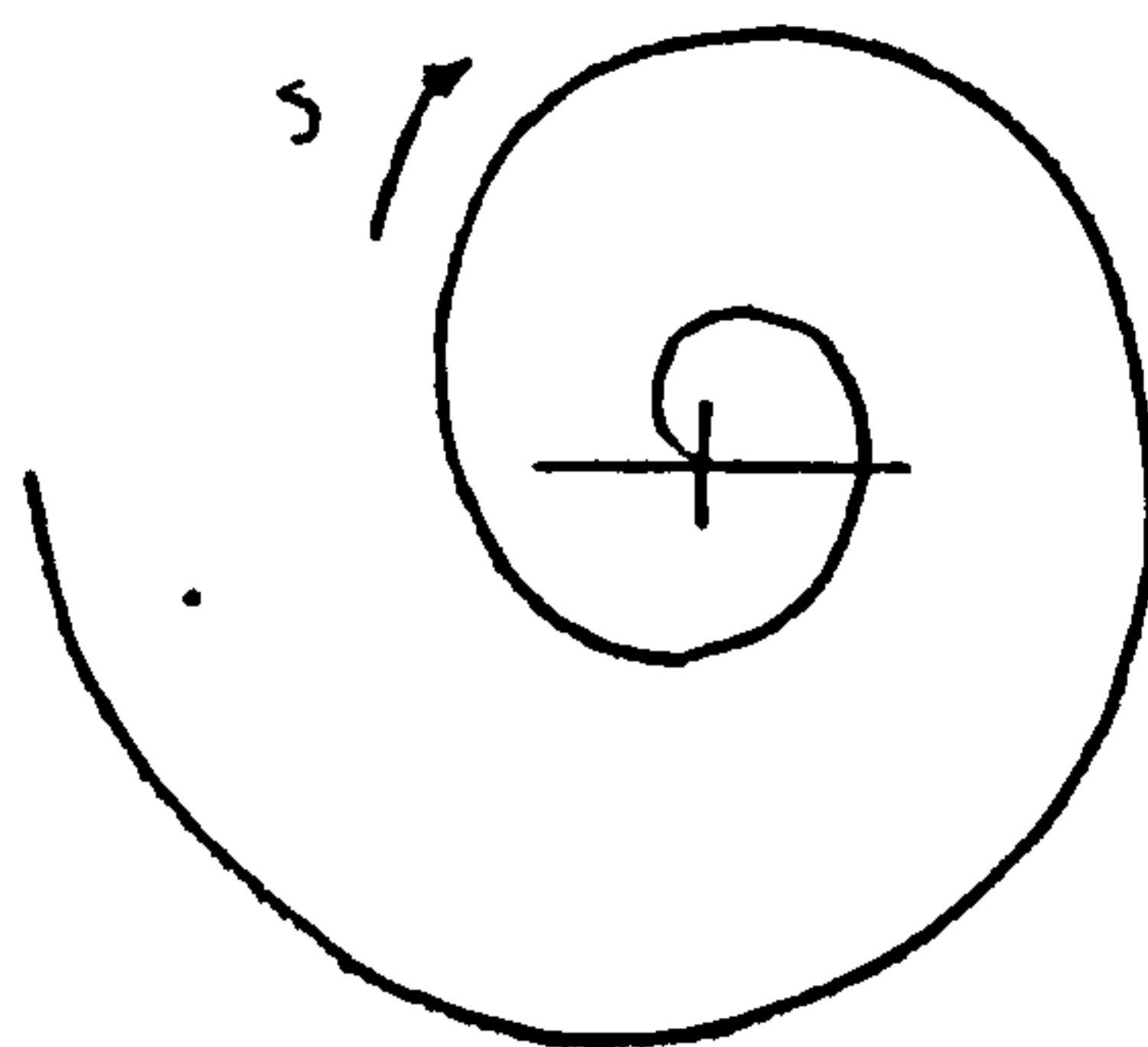

NOTES 1. No plotting takes place

NAME MASK

FUNCTION Draws a shape masked by another

ARGUMENTS (*ARRAY, X, Y, WARRAY*)

*ARRAY* (Real array) stores a 2-d *Picasso* shape to be masked

*X, Y* (Real inches) is the amount of shift applied to the drawn shape

*WARRAY* (Real array) stores a 2-d *Picasso* shape that masks array

EXAMPLE *CALL MASK(A, 0.0, 0.0, B)*

This statement draws out shape *A* masked by shape *B*.

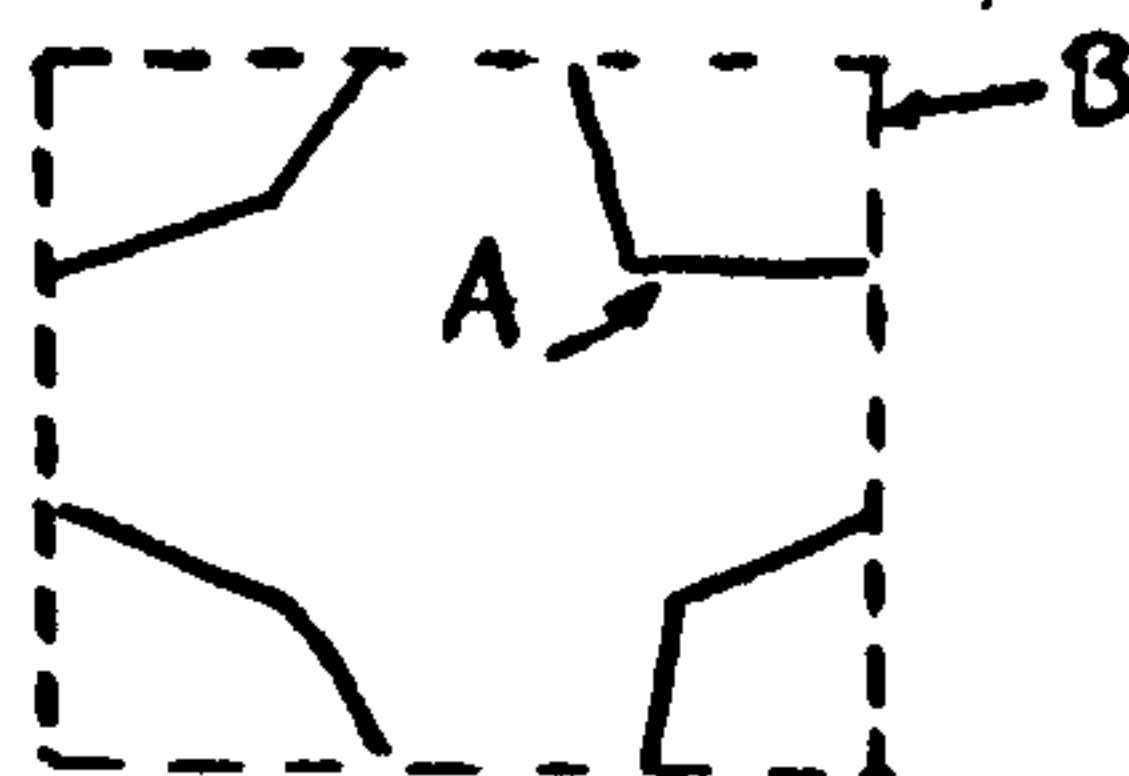

NOTES 1. The masking shape is not drawn

2. Clockwise masking contours produce holes anti-clockwise contours mask



NAME MIRROR (Mirror Image)

FUNCTION Produces a reflection of a 2-dimensional *Picaso* shape about a specified line

ARGUMENTS (*ARRAY, X1, Y1, X2, Y2, ARRAY1*)

*ARRAY* (Real array) stores a 2-d *Picaso* shape

*X1, Y1* (Real inches) is one point on the mirror line

*X2, Y2* (Real inches) is a second point on the mirror line

*ARRAY1* (Real array) stores the reflected shape

EXAMPLE *CALL MIRROR(TRIANG, 5.0, 0.0, 5.0, 10.0, REFLEC)*

This statement derives the reflection of the shape stored in *Triang* about the line passing through the points  $(5.0, 0.0)$ ,  $(5.0, 10.0)$ . The reflection is stored in *Reflec*.

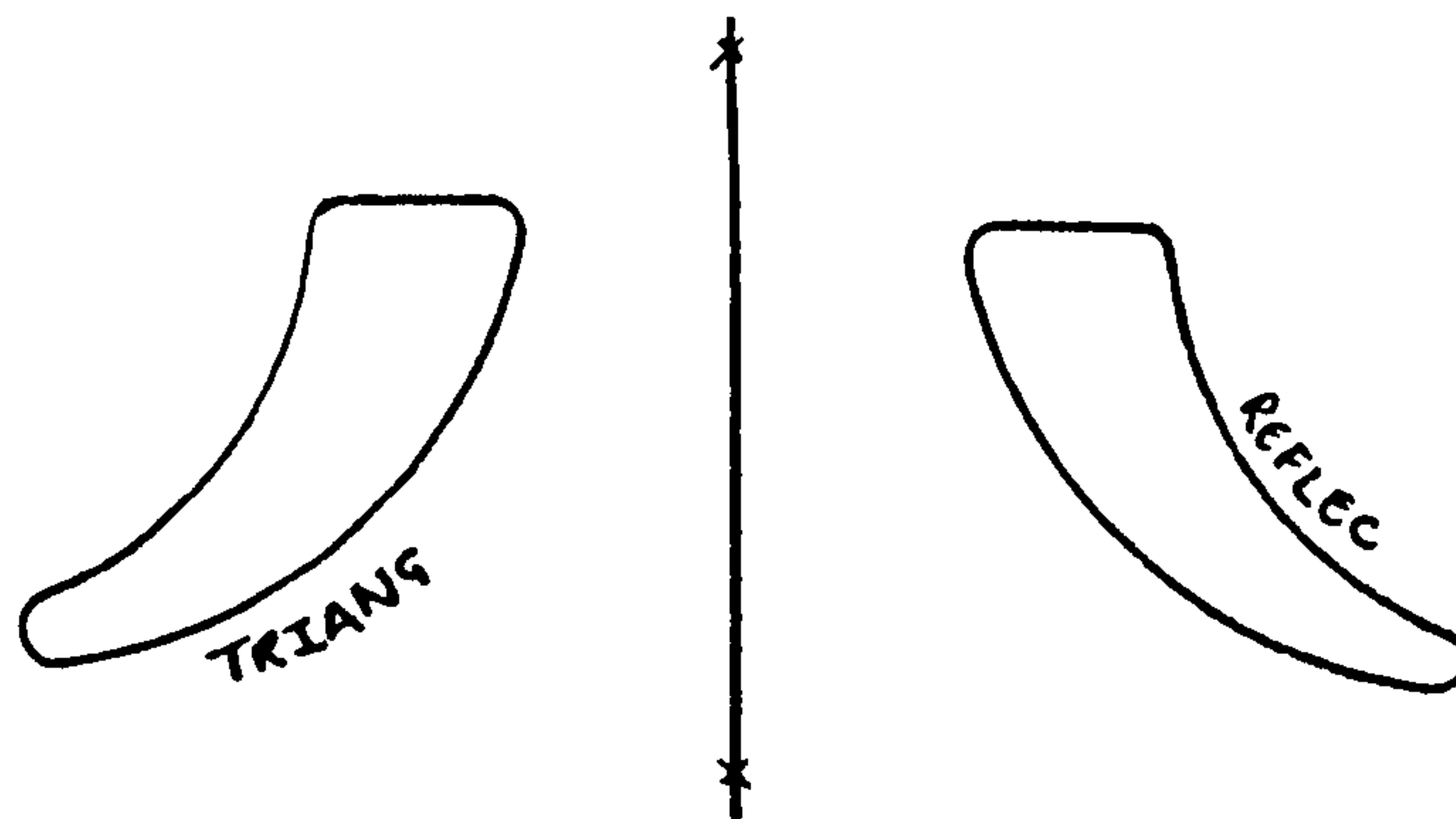

NOTES 1. No plotting takes place

NAME MIX2D (Mix coordinates in a 2-d shape)

FUNCTION Interchanges the coordinates of a 2-d *Picasso* shape

ARGUMENTS (*ARRAY,N1,N2,ARRAYA*)

*ARRAY* (Real array) stores a 2-d *Picasso* shape

*N1,N2* (Integer) reference the X & Y coordinates positions

N1	N2	X	Y	OLD COORDINATES
1	1	X	X	
1	2	X	Y	
2	1	Y	X	NEW COORDINATES
2	2	Y	Y	

*ARRAYA* (Real array) stores the '*mixed*' shape

EXAMPLE *CALL MIX2D(A,2,1,B)*

This statement interchanges the X and Y coordinates stored in the shape A and stores the result in B.

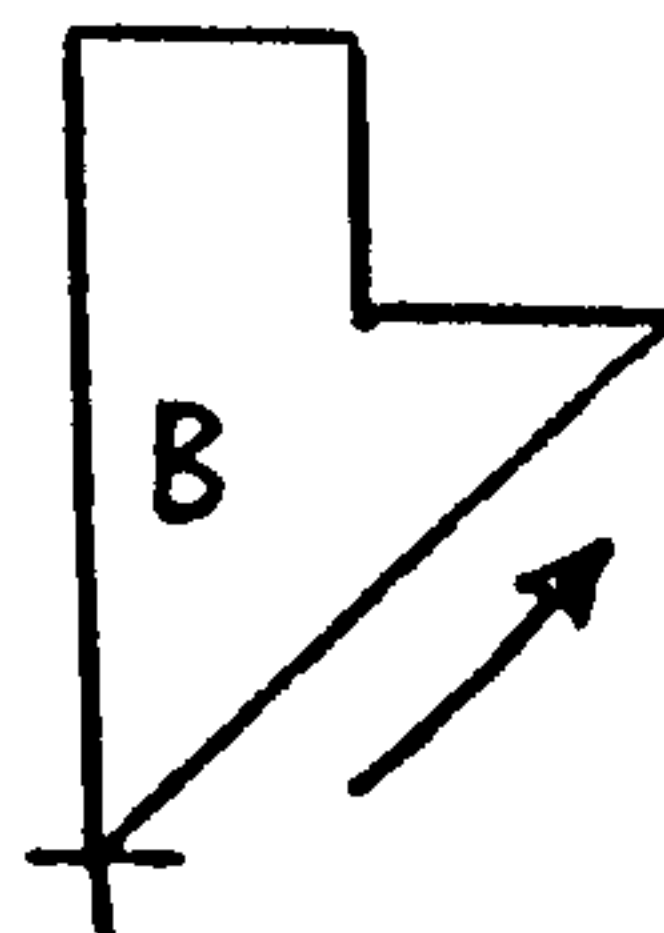
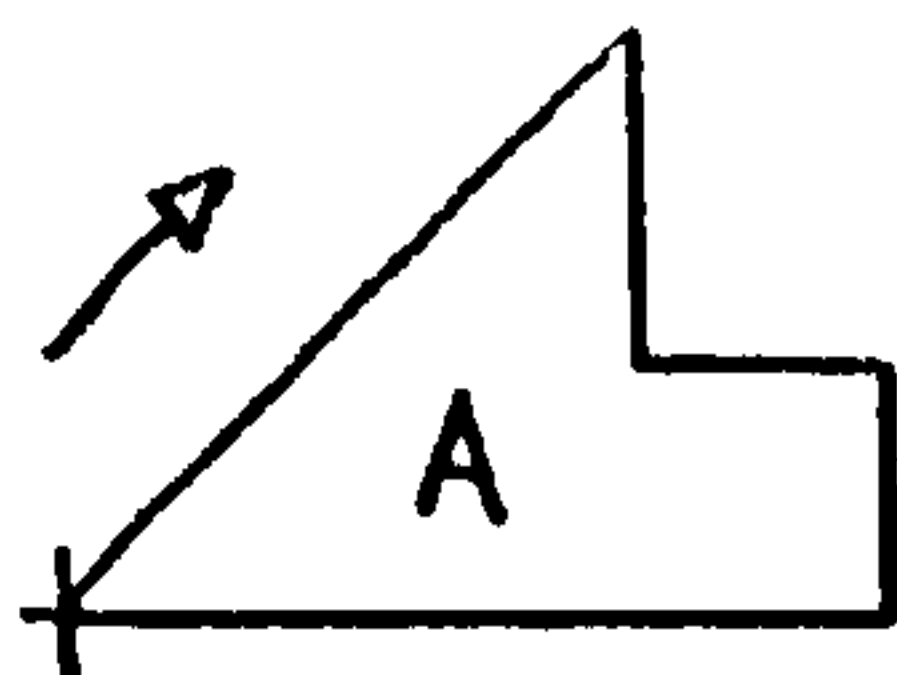

#### NOTES

1. No plotting takes place
2. The vertex sequence is reversed
3. N1 & N2 may be +VE or -VE to enable the sign of coordinates to be changed.

## PICASO SYSTEM

## MIX3D

**NAME** MIX3D (Mix coordinates in a 3-d object)

**FUNCTION** Interchanges the coordinates of a 3-d *Picaso* object

**ARUGMENTS** (*ARRAY,N1,N2,N3,ARRAYA*)

*ARRAY* (Real array) stores a 3-d *Picaso* object

*N1,N2,N3* (Integer) reference the X,Y & Z coordinate positions

N1	N2	N3	X	Y	Z	OLD COORDINATES
1	2	3	X	Y	Z	
1	3	2	X	Z	Y	
2	1	3	Y	X	Z	NEW
2	3	1	Y	Z	X	COORDINATES
3	1	2	Z	X	Y	
3	2	1	Z	Y	X	

*ARRAYA* (Real array) stores the '*mixed*' object

**EXAMPLE** *CALL MIX3D(A,2,1,3,B)*

This statement interchanges the X and Y coordinates and leaves the Z coordinate untouched, storing the result in *B*.

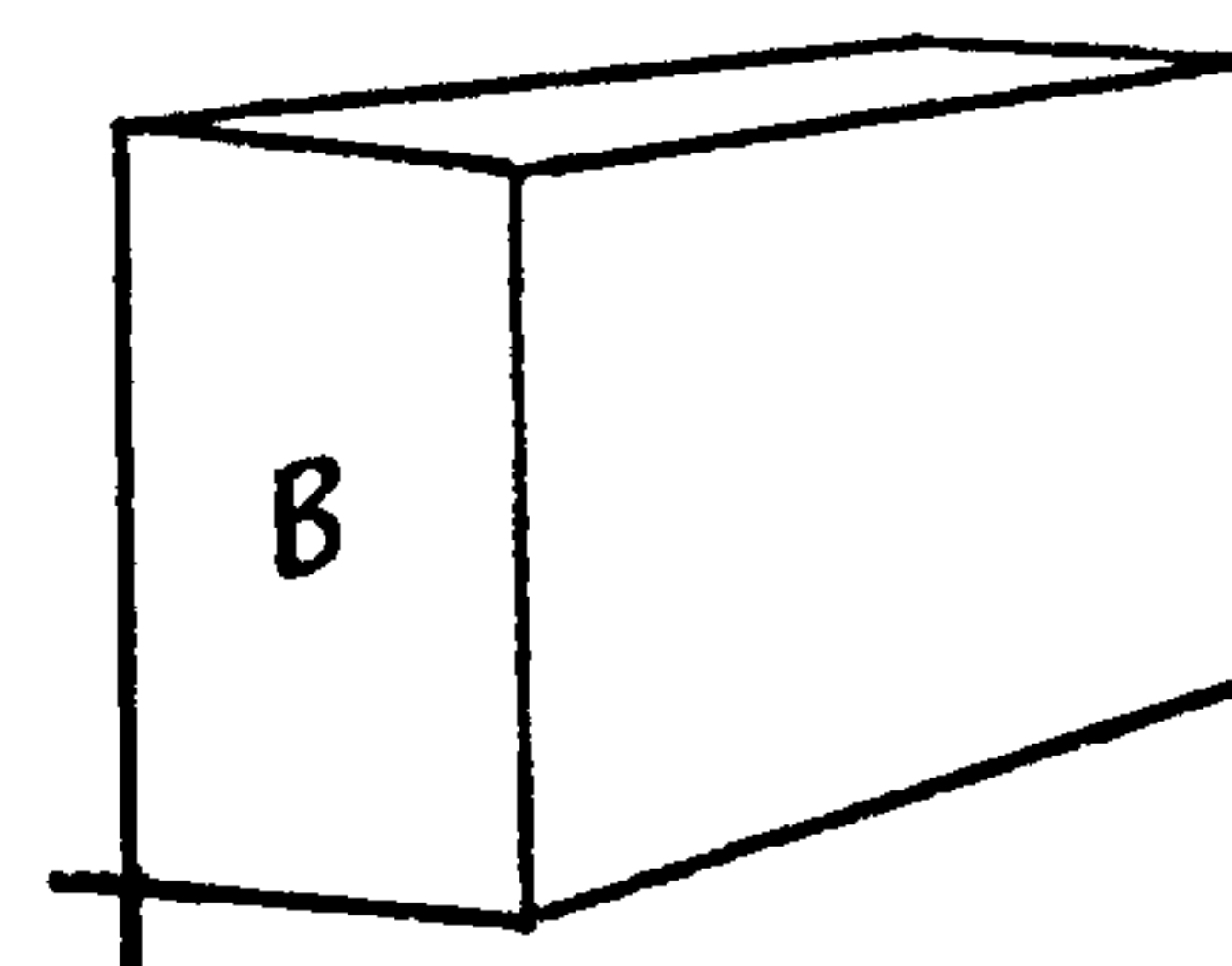
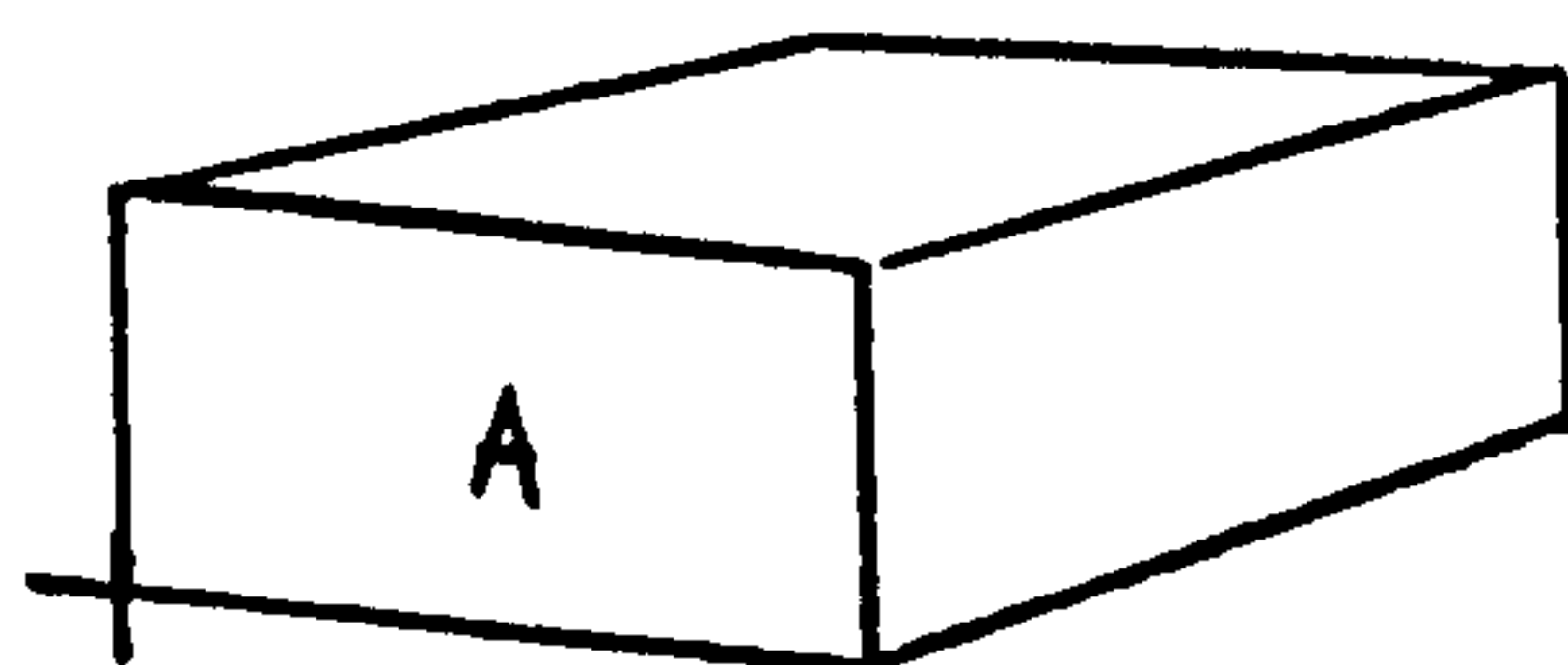
**NOTES**

1. No plotting takes place
2. The vertex sequences are reversed
3. *N1, N2 & N3* may be +VE or -VE to enable the sign of coordinates to be changed.

NAME MODSH (Modulate Shape)

FUNCTION Modulates the lines describing a 2-dimensional *Picasso* shape with a 2-dimensional *Picasso* contour

ARGUMENTS (*ARRAY, CONTOR, F, ARRAY1*)

*ARRAY* (Real array) stores a 2-d *Picasso* shape

*CONTOR* (Real array) stores a 2-d *Picasso* contour

*F* (Real) is the amplitude factor for contour

*ARRAY1* (Real array) will store the modulated shape

EXAMPLE *CALL MODSH(BOX, CON, 1.0, BOX1)*

This statement takes the shape stored in *box* and joins the points with the contour stored in *con*. The contour in *con* is unmodified as *F=1.0* the modulated shape is stored in *box1*.

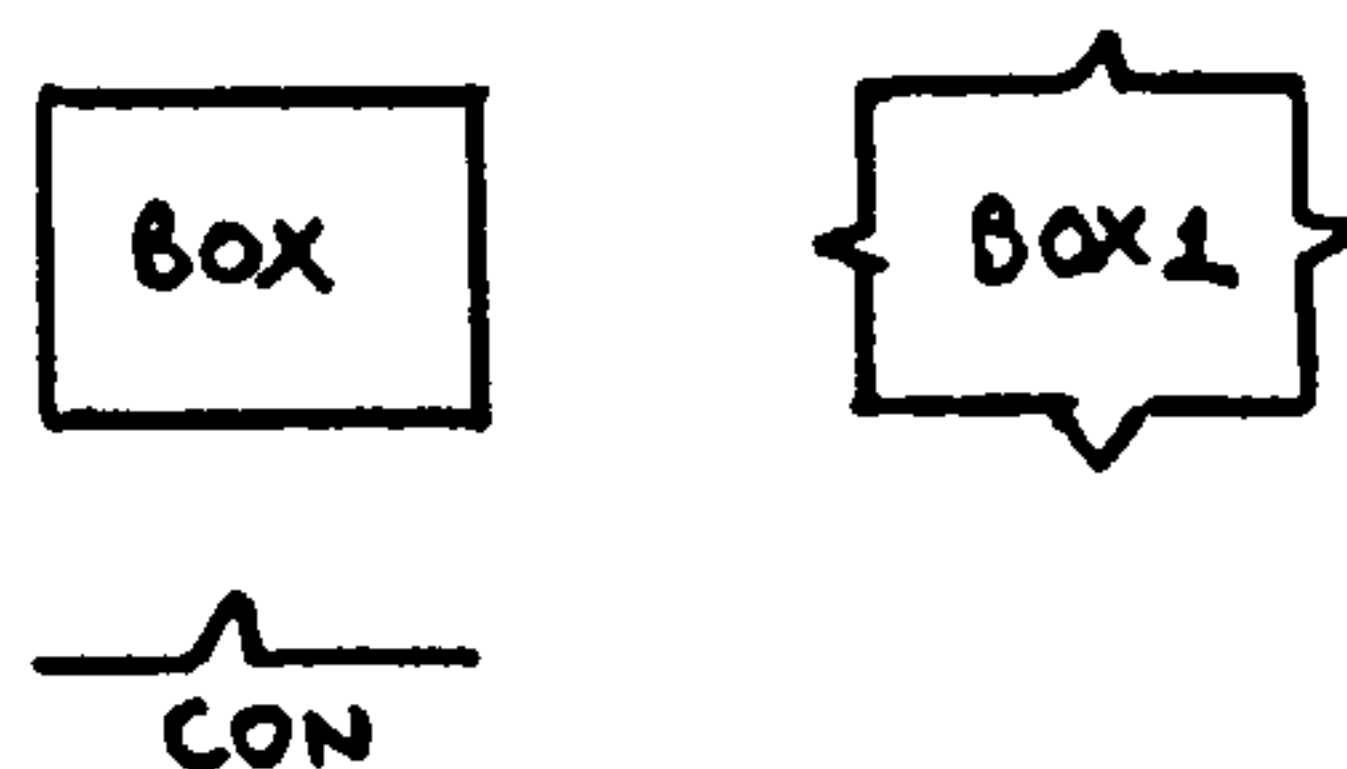

- NOTES
1. No plotting takes place
  2. Array1 must not be array

NAME           NDIMEN (Dimension)

FUNCTION       A function to calculate the number of elements  
                  required to contain a given *Picasso* structure.

ARGUMENTS     (*ARRAY*)

*ARRAY*   (Real array) stores a *Picasso* structure

TYPE           Ndimen is an integer type function

EXAMPLE        *I=NDIMEN(BOX)*

                  This statement returns the number of posi-  
                  tions used by the shape stored in *box*.

NAME NLINES (Number of lines)

FUNCTION This function determines the number of lines contained in a 2-dimensional *Picasso* shape.

ARGUMENTS (*ARRAY*)

*ARRAY* (Real array) stores a *Picasso* structure

FUNCTION Nlines is an integer function

EXAMPLE *I=NLINES(BOX)*

This statement determines the number of lines stored in *box*.

NAME           NORMAL (Normalize)

FUNCTION       Adjusts the coordinates of a 2-dimensional *Picaso* shape such that a specific point is located at a given coordinate. The rest of the points are normalized about this point.

ARGUMENTS     (*ARRAY,NL,NP,X,Y*)

*ARRAY*       (Real array) stores a 2-d *Picaso* shape

*NL*           (Integer) references the line containing the point

*NP*           (Integer) references the point on the line

*X,Y*          (Real inches) is the coordinate of the point

EXAMPLE       *CALL NORMAL(BOX,1,1,0.0,0.0)*

This statement adjusts the coordinates of *box* such that the 1st point on the 1st line is set to (0.0,0.0)

NOTES         1. No plotting takes place

(1)26.03.75

**NAME**        NPOINT (Number of points)

**FUNCTION**   Returns the number of points in a contour on a *Picasso* structure.

**ARGUMENTS** (*ARRAY, NC*)

*ARRAY*    (Real array) stores a 2 or 3-d *Picasso* structure

*NC*        (Integer) references the contour

**EXAMPLE**    *N=NPOINT(BOX,1)*

              This statement establishes how many points there are on the *first* contour of *box*.



**NAME** NSUB (Subscript number)

**FUNCTION** Returns the subscript of the point count descriptor in the 1'th contour of a *Picasso* structure

**ARGUMENTS** (*ARRAY, L*)

*ARRAY* (Real array) stores a 2 or 3-d *Picasso* structure

*L* (Integer) references the contour in the structure

**EXAMPLE** *N=NSUB(BOX, 2)*

This statement returns the subscript of the 2nd point count descriptor.

NAME NXSUB (Number of X subscript)

FUNCTION Returns the number of the X subscript of a point in a *Picasso* structure

ARGUMENTS (*ARRAY, NC, NP*)

*ARRAY* (Real array) stores a *Picasso* structure

*NC* (Integer) references the contour

*NP* (Integer) references the vertex

EXAMPLE  $N = \text{NXSUB}(A, 1, 1)$

This statement sets  $N$  to the xsubscript of the *first* vertex on the *first* contour

NAME       NYSUB (Number of Y subscript)

FUNCTION   Returns the number of the Y subscript of a point in a  
*Picasso* structure

ARGUMENTS  (*ARRAY,NC,NP*)

*ARRAY*    (Real array) stores a *Picasso* structure

*NC*       (Integer) references the contour

*NP*       (Integer) references the vertex

EXAMPLE    *N=NYSUB(A,1,1)*

This statements sets *N* to the Y subscript of  
the *first* vertex on the *first* contour

NAME NZSUB (Number of Z subscript)

FUNCTION Returns the number of the Z subscript of a point in a *Picasso* structure

ARGUMENTS (*ARRAY, NC, NP*)

*ARRAY* (Real array) stores a *Picasso* structure

*NC* (Integer) references the contour

*NP* (Integer) references the vertex

EXAMPLE .  $N = \text{NZSUB}(A, 1, 1)$

This statement sets *N* to the Z subscript of the *first* vertex on the *first* contour

NAME            OBJECT

FUNCTION       Reads in a three-dimensional *Picasso* structure from  
                 cards and stores it    in an array

ARGUMENTS     (*ARRAY*)

*ARRAY*    (Real array)

EXAMPLE       *CALL OBJECT(BOX)*

                 This statements reads in a shape and stores it  
                 in *box*.

NOTES          1. Each point requires 3 coordinates

                      X cols 4-13

                      Y cols 14-23

                      Z cols 24-33

                 2. Each surface is terminated by

                      EOL cols 1-2

                 3. Each object is terminated by

                      EOS cols 1-3

                 4. Each surface should be specified in a clock-wise  
                 sense.

NAME ORIGIN

FUNCTION Changes the position of the origin

ARGUMENTS (X,Y)

X,Y (Real inches) specifies the position of the new origin relative to the existing origin

EXAMPLE *CALL ORIGIN(5.0,5.0)*

This changes the *Origin* to a point 5.0 inches from the x-axis and 5.0 inches from the y-axis

NOTES

1. The origin can not be located off the paper
2. During the origin change the pen is up

NAME PARAB (Parabola)

FUNCTION Stores a parabolic curve in an array

ARGUMENTS (*ARRAY, XSPAN, YSPAN, N*)

*ARRAY* (Real array) stores the parabola

*XSPAN* (Real inches) is the total width of the parabola

*YSPAN* (Real inches) is the height of the parabola

*N* (Integer) is the number of points in the curve

EXAMPLE *CALL PARAB(A, 4.0, 4.0, 20)*

This statements stores a parabola in *A, 4.0* by *4.0* inches

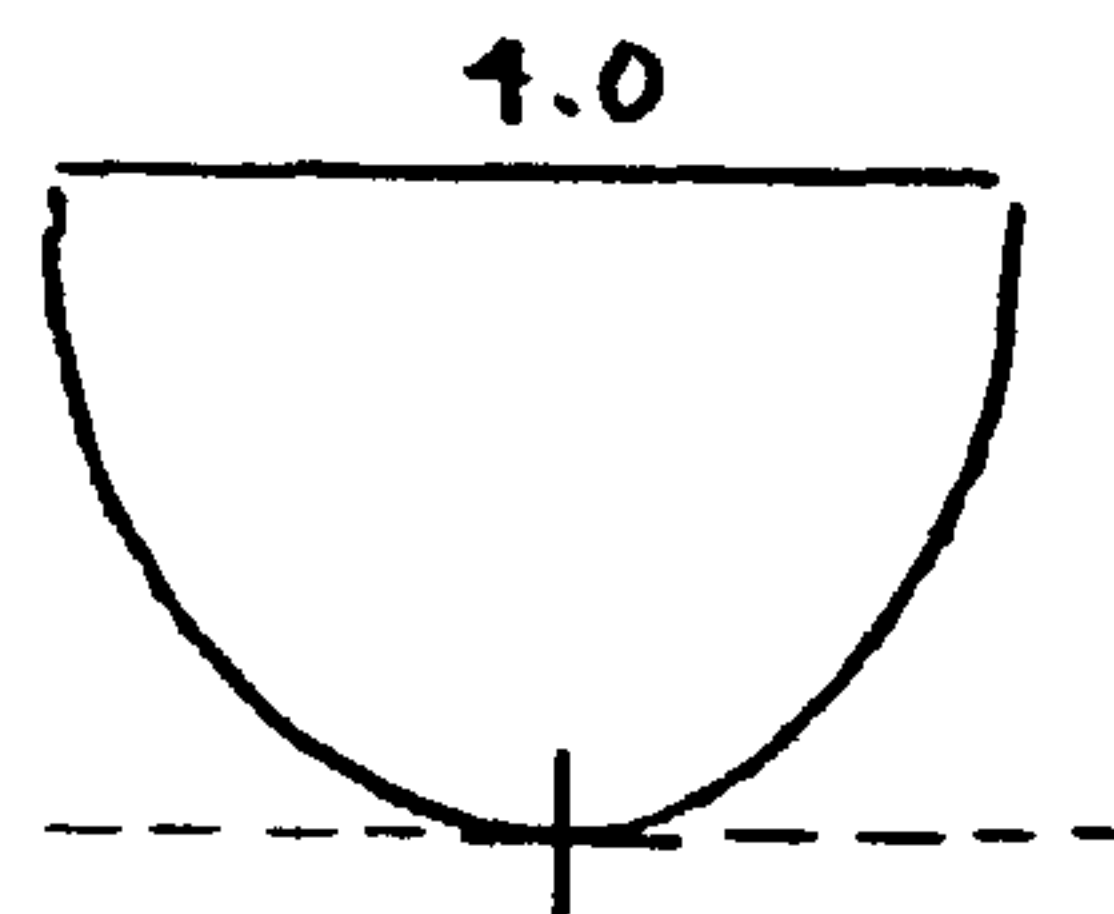

NOTES 1. No plotting takes place

NAME        PERSP (Perspective)

FUNCTION    Transforms a point in 3-d space onto a 2-d picture plane to obtain perspective or wide-angle effects.

ARGUMENTS  ( $X, Y, Z, XW, YW$ )

$X, Y, Z$     (Real inches) are the coordinates of the point in 3-d space

$XW, YW$     (Real inches) are the coordinates of the transformed point on the window plane

EXAMPLE    `CALL PERSP(5.0,2.0,1.0,X,Y)`

This statement sets  $X, Y$  to the perspective view of  $5.0, 2.0, 1.0$

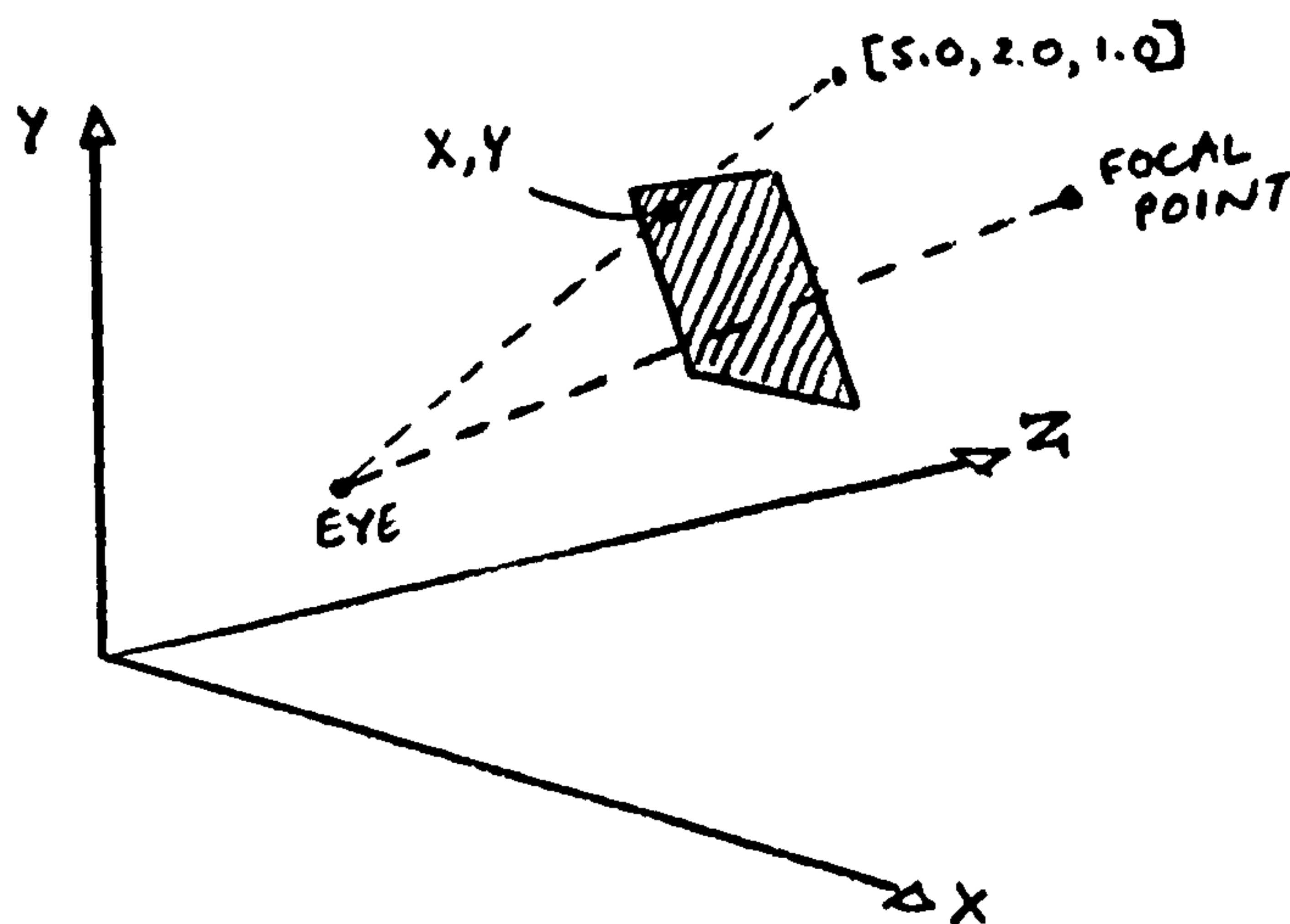

#### NOTES

1. Normal perspective is obtained if eye has been previously called. Wide-angle effects are obtained if fishi has been called
2. No plotting takes place



NAME PLIT

FUNCTION Is the basic plotting command in the *Picasso* system

ARGUMENTS (*X,Y,PEN*)

*X,Y* (Real inches) is the point to which the pen moves

*PEN* (Integer) is the pen control parameter

Pen=2=Pen Down

Pen=3=Pen Up

Pen=-VE=Change Origin

EXAMPLE *CALL PLIT(1.0,1.0,2)*

This statements moves the pen from its present condition to the point *1.0,1.0* with the pen down

NAME POLYGN (Polygon)

FUNCTION Stores a regular polygon as a 2-dimensional *Picaso* shape

ARGUMENTS (*ARRAY,RADIUS,N*)

*ARRAY* (Real array) stores the polygon

*RADIUS* (Real inches) is the radius of the polygon

*N* (Integer) is the number of sides

EXAMPLE *CALL POLYGN(S,1.0,100)*

This statements stores a 100 sided Polygon of radius 1.0 inch in *S*, with the origin at the centre

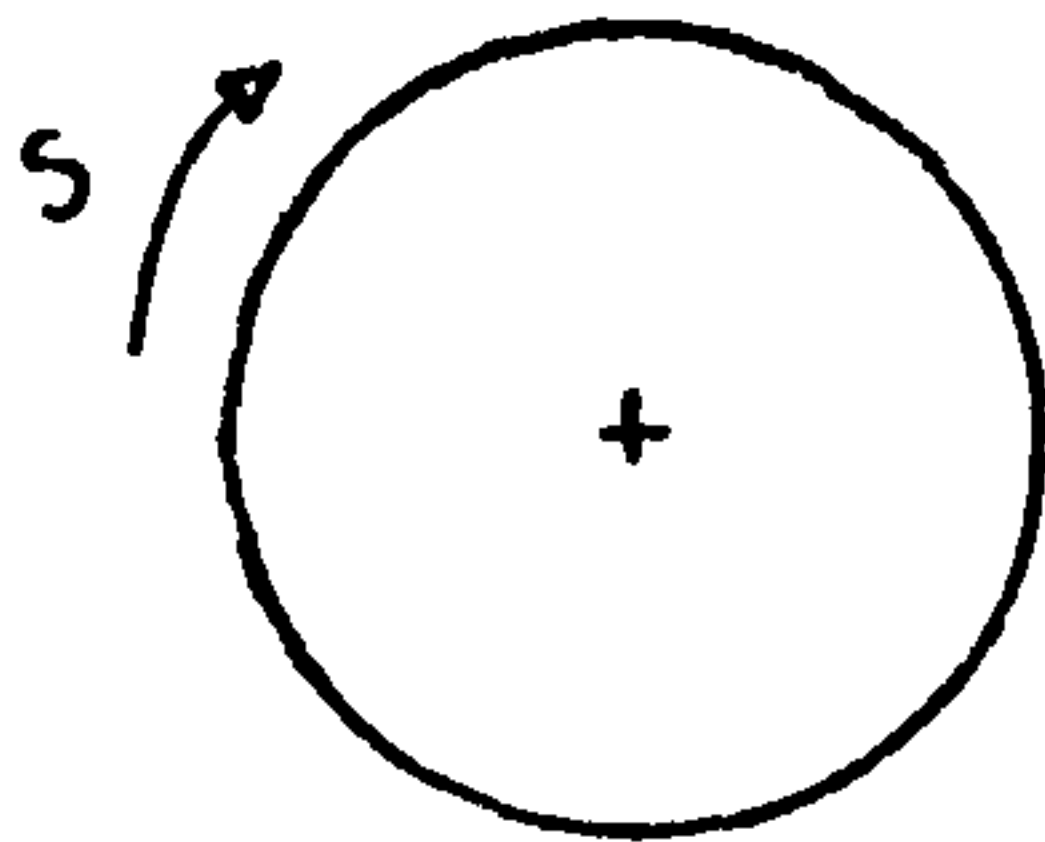

NOTES

1. No plotting takes place
2. The first point is always:  
X=Radius, Y=0.0
3. Coordinates are in clockwise sequence
4. The array must be dimensioned to at least (2\*N)+3.

**NAME** POSCON (Position on a contour)

**FUNCTION** Returns the height of the contour at a position specified by two coordinates

**ARGUMENTS** (*ARRAY, NX, NY, XINC, YINC, XC, YC, V*)

*ARRAY* (Real array) stores a 2-d open contour

*NX* (Integer) is the number of X increments

*NY* (Integer) is the number of Y increments

*XINC* (Real inches) is the size of the X increment

*YINC* (Real inches) is the size of the Y increment

*XC, YC* (Real inches) are the coordinates of the axis about which rotation occurs

*V* (Real inches) is the default value when the extent of the contour is exceeded

**EXAMPLE**  $H = \text{POSCON}(A, 20, 10, 0.1, 0.2, 3.0, 3.0, 0.0)$

This statement sets  $H$  to a value that is equivalent to the height of the contour stored in  $A$  at the specified point

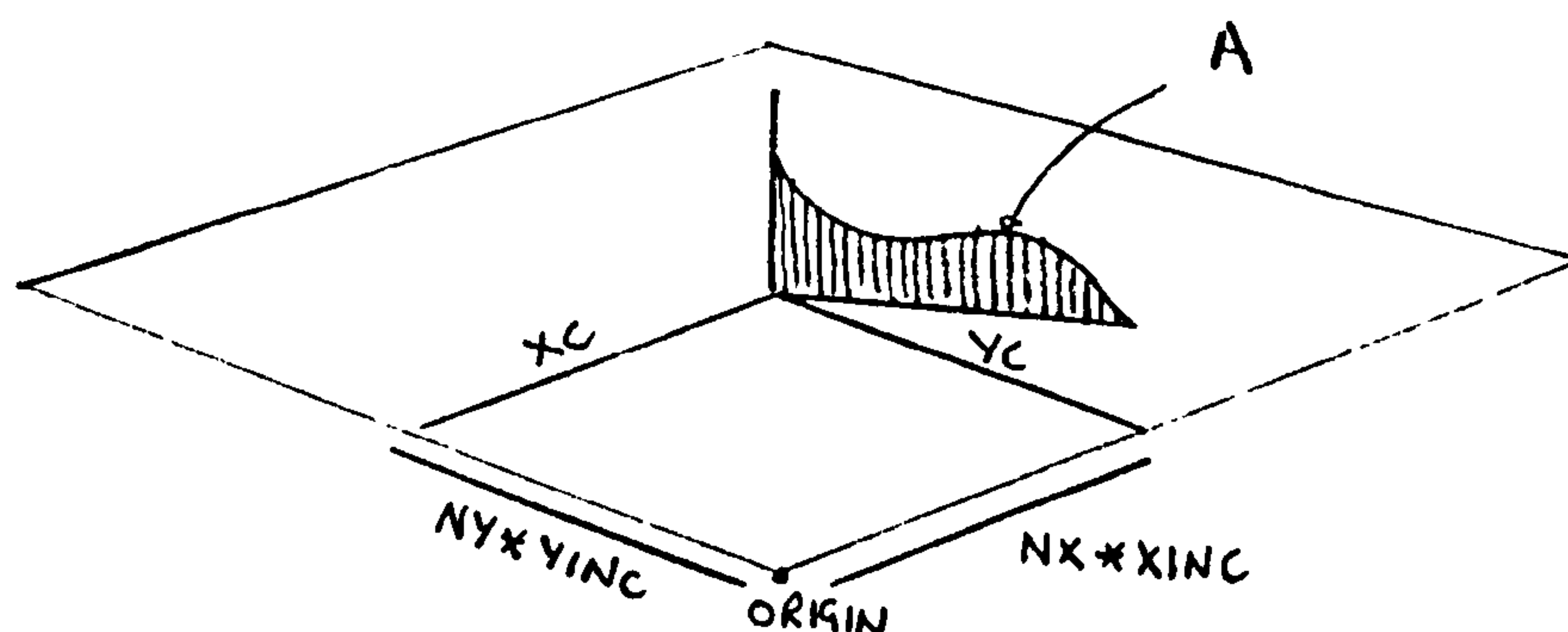

NAME        PRINT

FUNCTION   Prints out the coordinate values stored in a shape

ARGUMENTS (*ARRAY*)

*ARRAY*    (Real array) stores a 2 or 3-d *Picasso*  
          structure

EXAMPLE    *CALL PRINT(BOX)*

          This statement produces a listing of the  
          coordinates of *box*.

NAME PULL

FUNCTION Stretches or shears a shape about the point X,Y

ARGUMENTS (*ARRAY,X,Y,THETA,F,ARRAYB*)

*ARRAY* (Real array) stores the shape to be stretched

*X,Y* (Real inches) is the point that suffers zero stretch

*THETA* (Real degrees) is the direction of stretch

*F* (Real) is the degree of stretch

*ARRAYB* (Real array) stores the stretched shape

EXAMPLE *CALL PULL(A,0.0,0.0,0.0,2.0,A)*

This statement stretches shape A about the origin in the X-direction by a factor of 2.0.

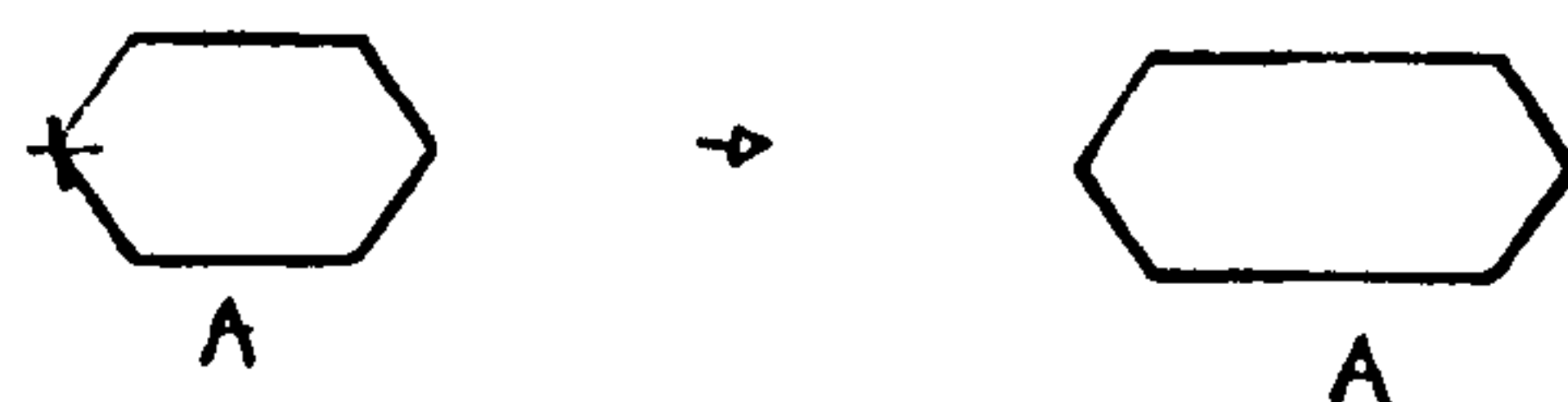

NOTES 1. No plotting takes place

NAME REMOVE

FUNCTION Removes a contour from a *Picasso* shape

ARGUMENTS (*ARRAY,N*)

*ARRAY* (Real array) stores a *Picasso* structure

*N* (Integer) references the contour to be removed

EXAMPLE *CALL REMOVE(BOX,2)*

This statement removes the *second* contour from *box* and shifts remaining contours along

NOTES 1. Applies to 2 and 3-d shapes

NAME REVERS (Reverse)

FUNCTION Reverses the sequence of vertices in a 2-d *Picasso* contour

ARGUMENTS (*ARRAY,N*)

*ARRAY* (Real array) stores a 2-d *Picasso* shape

*N* (Integer) references the contour to be reversed

EXAMPLE *CALL REVERS(BOX,1)*

This statement reverses the sequence of the vertices in the 1st contour of *box*.

NAME PYRAM (Pyramid)

FUNCTION Stores a 3-d pyramid in an array

ARGUMENTS (*ARRAY, BASE, HEIGHT*)

*ARRAY* (Real array) stores the pyramid

*BASE* (Real) is the width of the pyramid

*HEIGHT* (Real) is the height of the pyramid

EXAMPLE *CALL PYRAM(P, 1.0, 2.0)*

This statement stores a *two-inch* high pyramid in *P* with a *one-inch* base

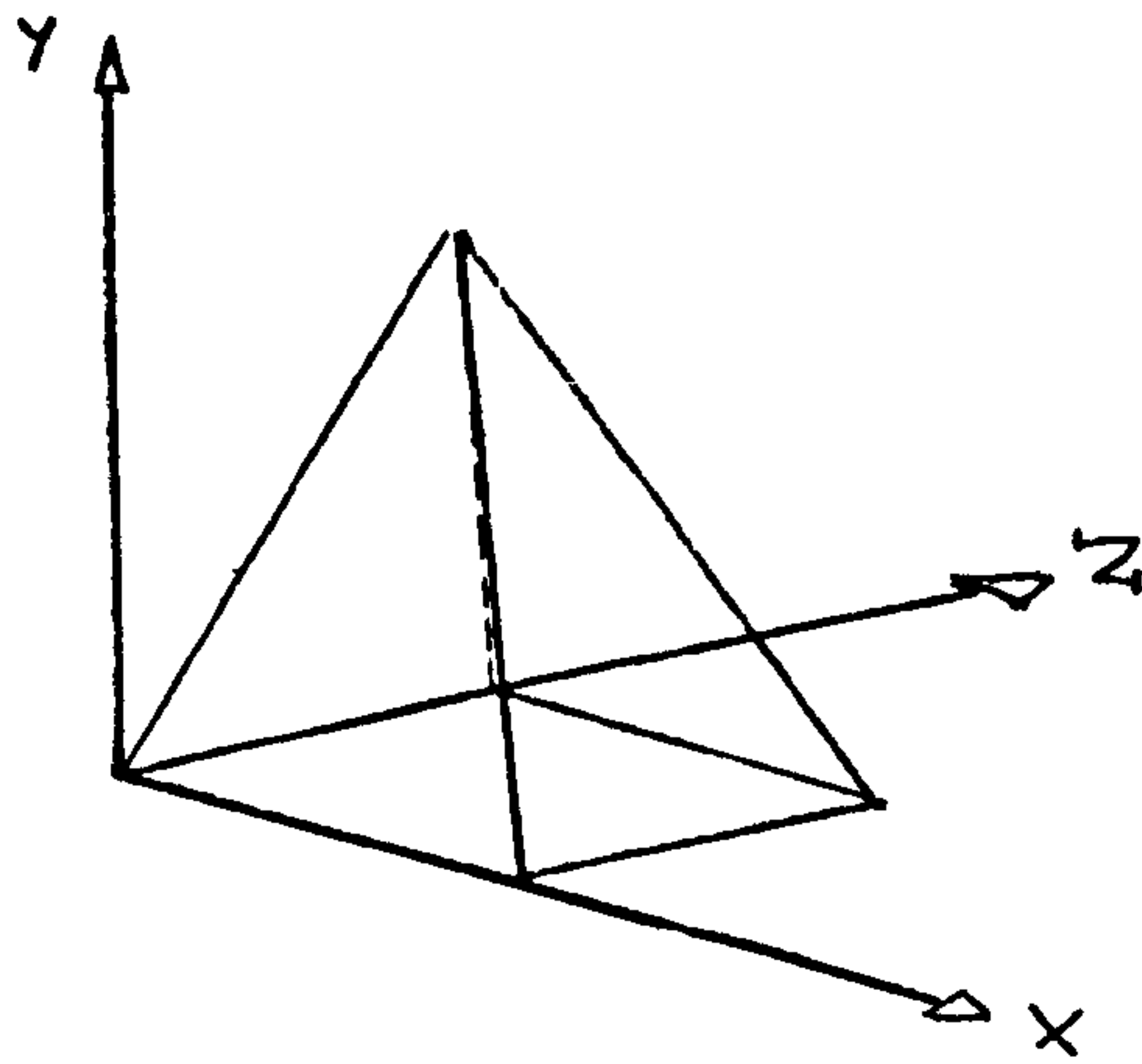



NAME        RECTNG (Rectangle)

FUNCTION    Stores a rectangle as a 2-dimensional *Picaso* shape

ARGUMENTS  (*ARRAY, SIDEA, SIDEB*)

*ARRAY*    (Real array) stores the rectangle

*SIDEA*    (Real inches) is the width

*SIDEB*    (Real inches) is the height

EXAMPLE    *CALL RECTNG(R, 2.0, 1.0)*

This statement stores a rectangle in *R* with a height of 1.0 inch and width of 2.0 inches. The lower left-hand corner is located at the origin



NOTES

1. No plotting takes place
2. The first point is the origin
3. Coordinates are in clockwise sequence
4. The array must be dimensioned to at least 13.

NAME RIPPLE

FUNCTION Chooses a new vertex to become the first vertex of a closed contour

ARGUMENTS (*ARRAY, NC, I*)

*ARRAY* (Real array) stores a 2-d *Picasso* shape

*NC* (Integer) references the contour to be rippled

*I* (Integer) is the direction of ripple

*I*=+VE Ripple forward

*I*=-VE Ripple backward

EXAMPLE *CALL RIPPLE(Q,1,1)*

This statement rotates the coordinates on the 1st contour of *Q* one step forward

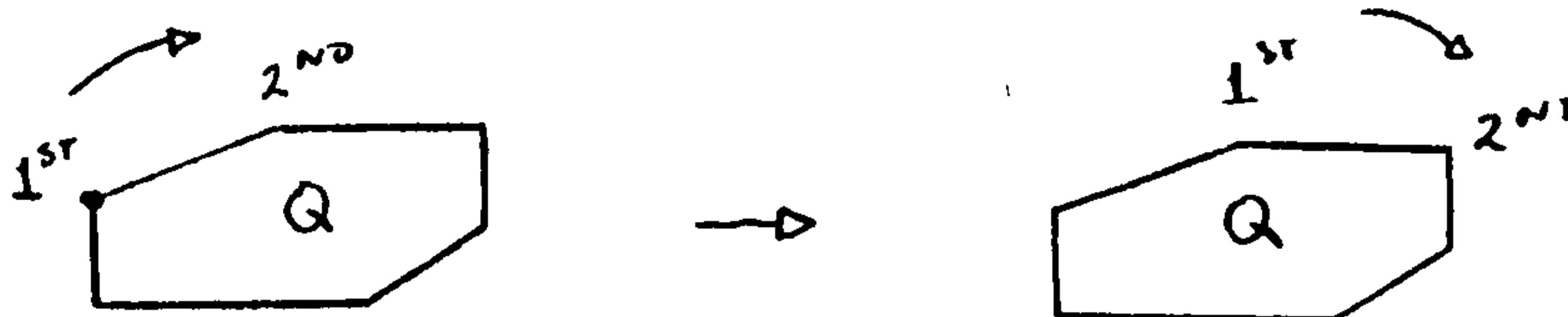

NOTES

1. No plotting takes place
2. The magnitude of *I* is imaterial, ripple can only shift one step.

NAME        RHODON (Rhodonea Curve)

FUNCTION    Stores a rhodonea curve as a 2-d *Picasso* shape

ARGUMENTS  (*ARRAY, RADIUS, NP, N*)

*ARRAY*    (Real array) stores the 2-d rhodonea

*RADIUS*   (Real inches) is the radius of the curve

*NP*        (Integer) is the number of petals in the  
            curve

*N*         (Integer) is the number of points in the  
            curve

EXAMPLE    *CALL RHODON(R, 2.0, 4, 100)*

            This statement stores a 4 petaled rhodonea  
            in *R*.

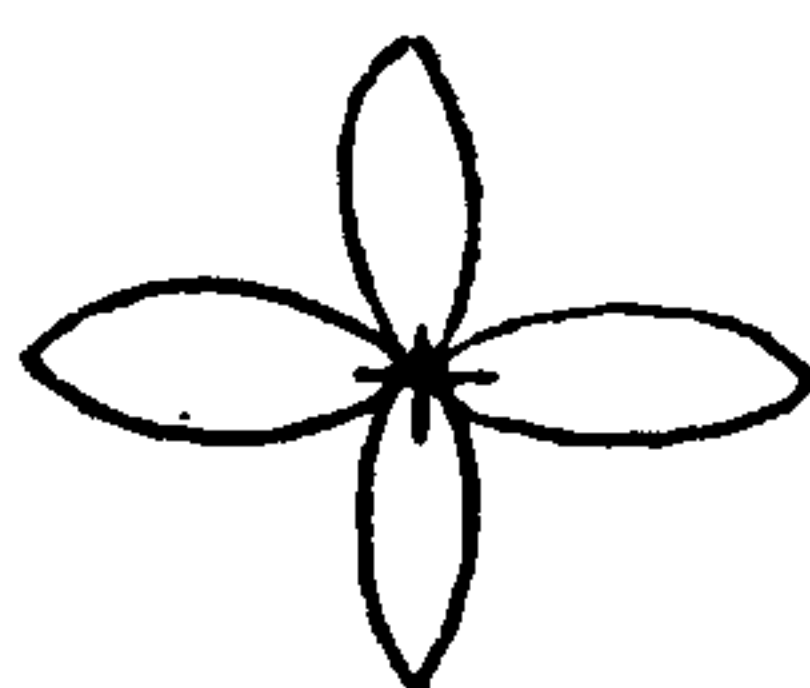

NOTES      1. No plotting takes place

NAME ROTATE

FUNCTION Rotates a 2-d *Picaso* shape about a specified point

ARGUMENTS (*ARRAY, XP, YP, THETA, ARRAYA*)

*ARRAY* (Real array) stores a 2-d *Picaso* shape

*XP, YP* (Real inches) is the centre of rotation

*THETA* (Real degrees) is the amount and direction of rotation

+VE = Anti-clockwise

-VE = Clockwise

*ARRAYA* (Real array) receives the rotated shape

EXAMPLE *CALL ROTATE(S, 0.0, 0.0, 40.0, S)*

This statement rotates the shape stored in *S* 40.0 degrees about the origin

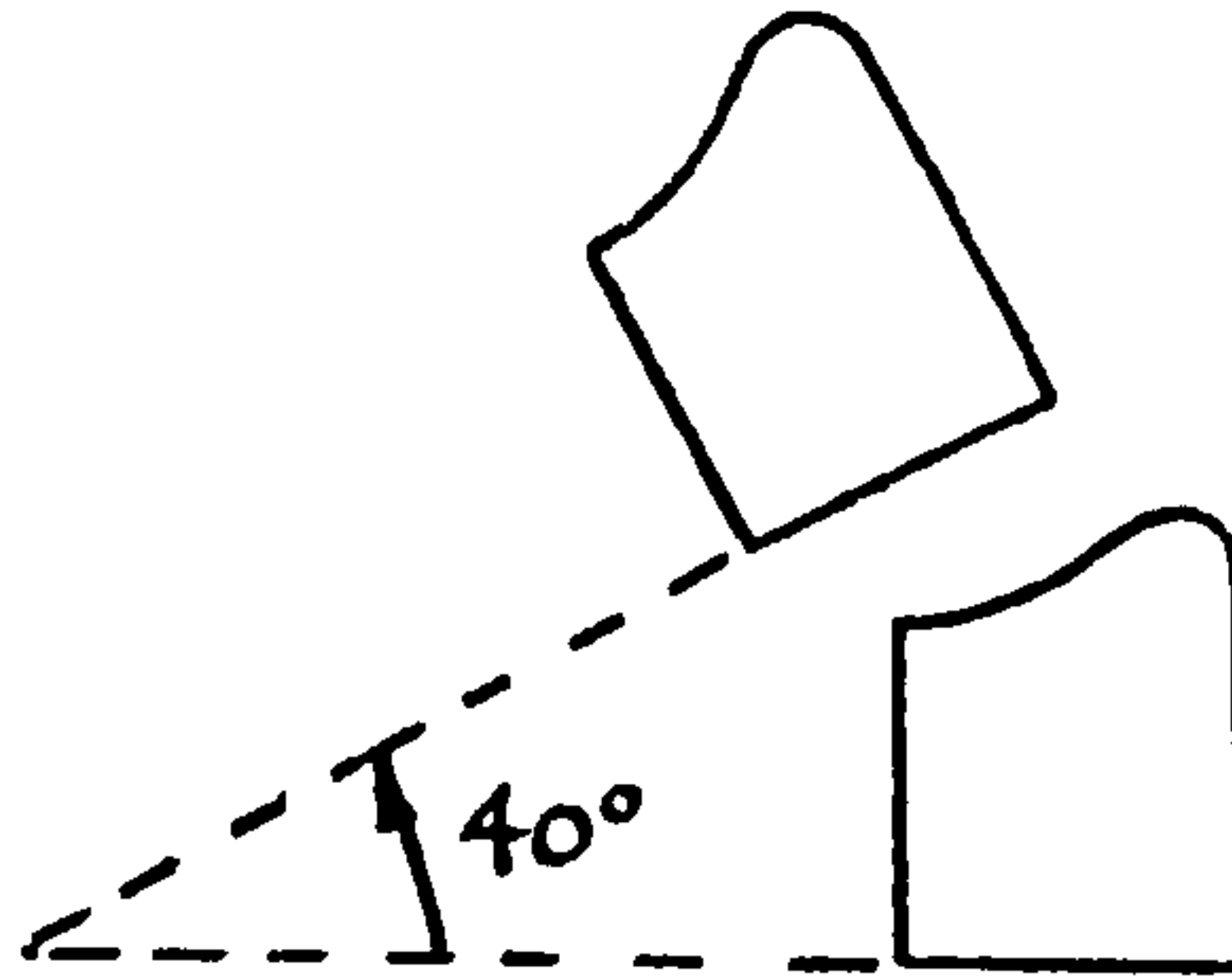

NOTES 1. No plotting takes place

NAME        ROW

FUNCTION   Plots out a row of 2-dimensional *Picasso* shapes

ARGUMENTS (*ARRAY, SIZE, N, XSP, X, Y*)

*ARRAY*    (Real array) stores a 2-d *Picasso* shape  
*SIZE*      (Real) is the degree of enlargement or  
reduction of the drawn shape relative to the  
original stored in array

*N*         (Integer) is the number of shapes to be  
drawn

*XSP*      (Real inches) is the horizontal displacement  
between two shapes

*YSP*      (Real inches) is the vertical displacement  
between two shapes

*X, Y*     (Real inches) is the amount of shift applied  
to the row of shapes

EXAMPLE    *CALL ROW(BOX, 1.0, 3, 1.0, 1.0, 0.0, 0.0)*

Draws out 3 shapes stored in *box* with their  
original size, displaced 1.0 inch horizontally  
and vertically, the entire row is shifted zero  
inches from the origin.

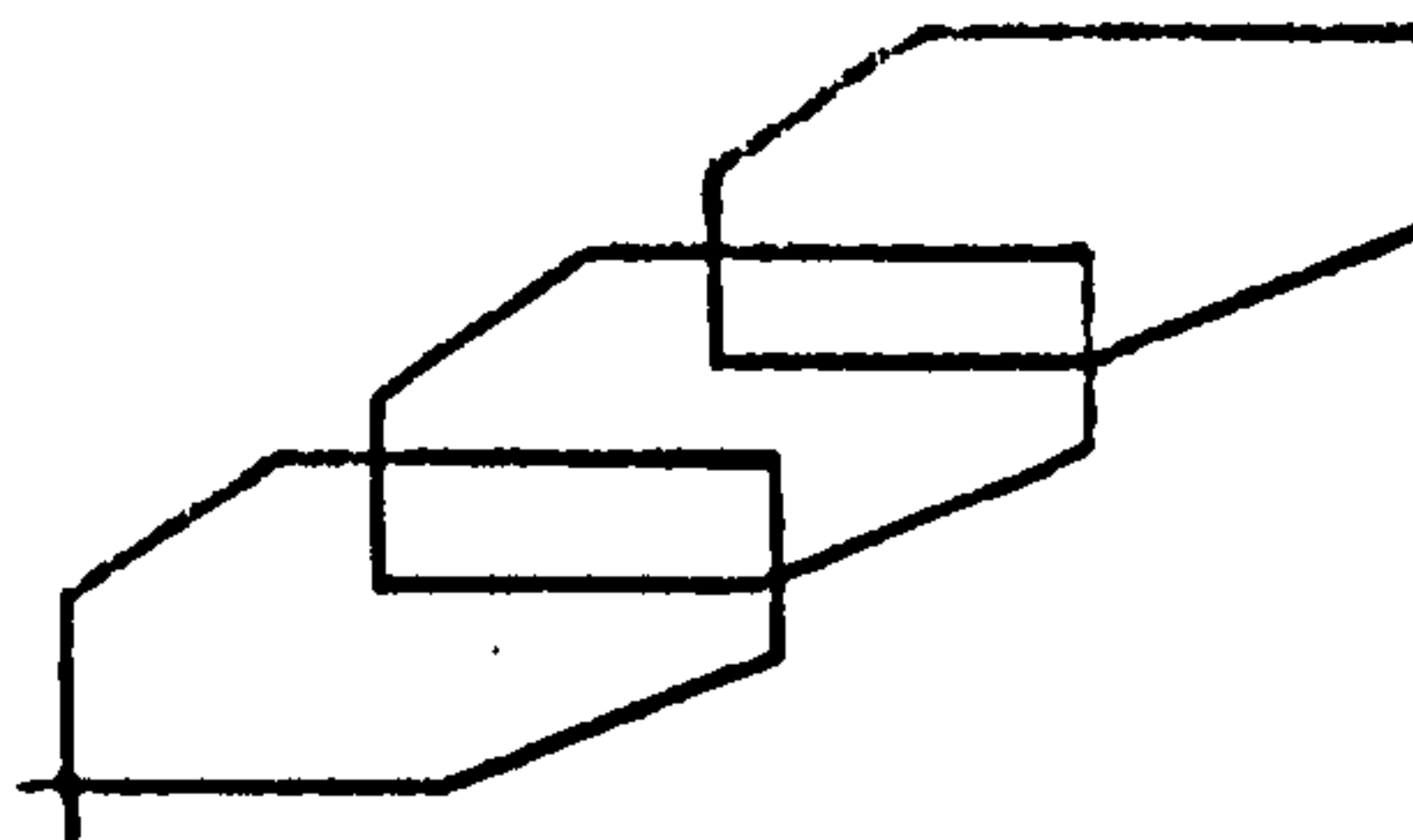

NOTES      1. Observe that *XSP* and *YSP* are not distances between  
two shapes, they are the distances between the same  
point on the displaced shapes.

NAME ROW2D (Draw a 2-d row in 3-d)

FUNCTION Draws out a three-dimensional version of a 2-d *Picasso* row of shapes

ARGUMENTS (*ARRAY, SIZE, N, XSP, YSP, X, Y, N1, N2, N3, V*)

*ARRAY* (Real array) stores a 2-d *Picasso* shape

*SIZE* (Real) alters the size of the final shape by 'size' items

*N* (Integer) is the number of shapes in the row

*XSP* (Real inches) is the distance between points on two shapes in the 'X' direction

*YSP* (Real inches) is the distance between points on two shapes in the 'Y' direction

*X, Y* (Real inches) is the degree of shift applied to the 2-d row

*N1, N2, N3* (Integer) determine the transformation

N1	N2	N3	X	Y	Z	(IN 3-D)
1	2	3	X	Y	V	
1	3	2	X	V	Y	
2	1	3	Y	X	V	IN 2-D
3	1	2	V	X	Y	
2	3	1	Y	V	X	
3	2	1	V	Y	X	

*V* (Real inches) is the value of the third dimension

EXAMPLE `CALL ROW2D(SQ,1.0,3,1.5,1.5,0.0,0.0,1,2,3,1.0)`

This statement produces the following transformation:

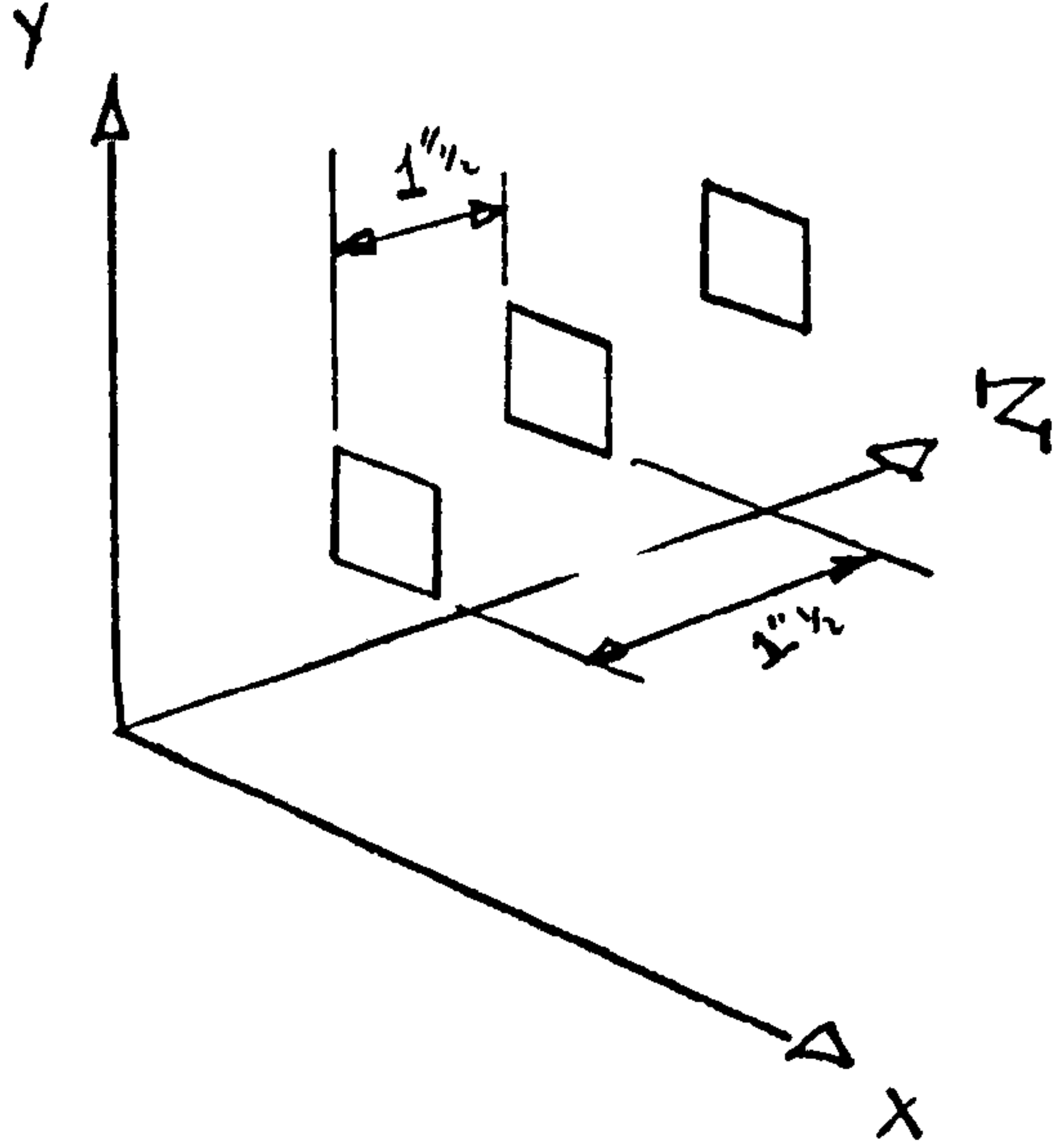

NAME SENSE

FUNCTION Determines whether a point is to the left, in-line or to the right of a reference line

ARGUMENTS  $(XP, YP, X1, Y1, X2, Y2)$

$XP, YP$  (Real inches) is the position of the test point

$X1, Y1$  (Real inches) are the coordinates of the first point on the line

$X2, Y2$  (Real inches) are the coordinates of the second point on the line

*SENSE* Is an Integer Function

= -1 if  $XP, YP$ , is to the right

= 0 if  $XP, YP$  is in-line

= +1 if  $XP, YP$  is to the left

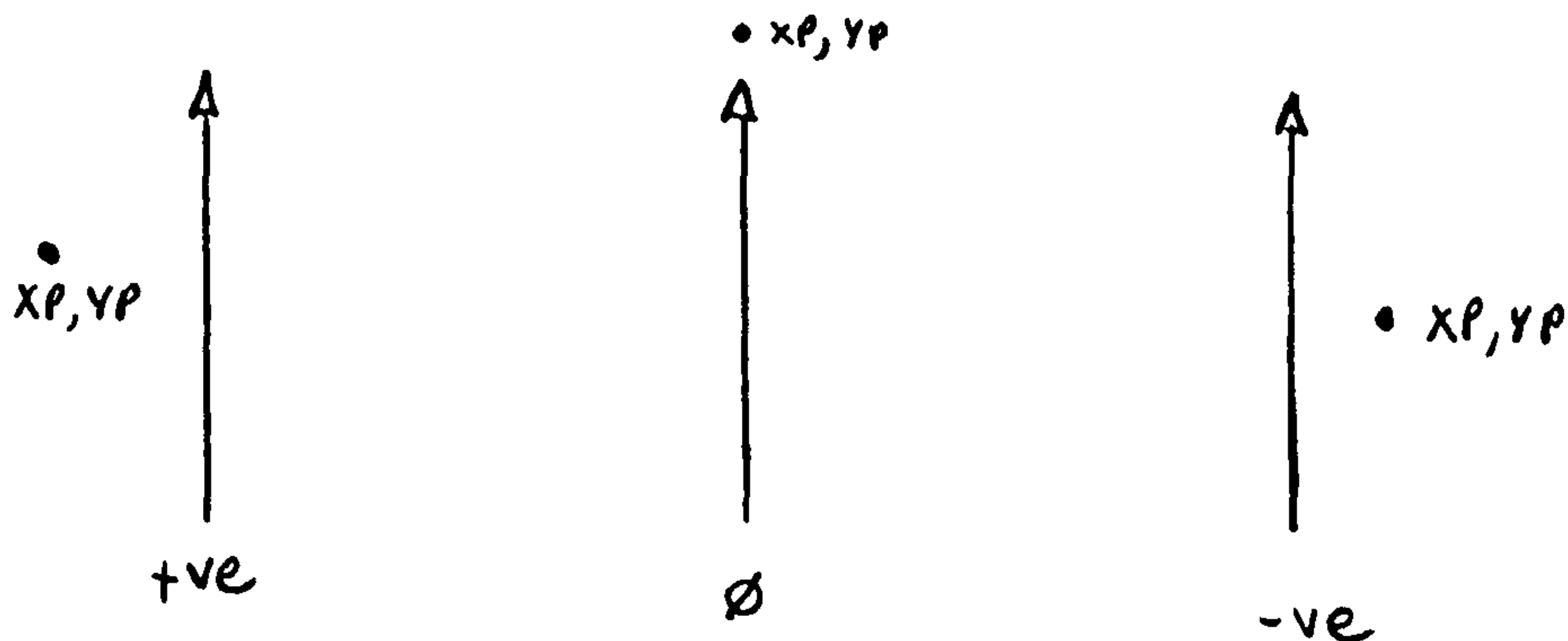



NAME SHADE

FUNCTION Shades a 2-d *Picaso* shape with parallel lines

ARGUMENTS (*ARRAY*, *THETA*, *SPACE*)

*ARRAY* (Real array) stores a 2-d *Picaso* shape

*THETA* (Real degrees) is the slope of the lines

*SPACE* (Real inches) is the distance between the shading lines

EXAMPLE *CALL SHADE(A, 45.0, 0.1)*

This statement shades the shape stored in *A* with line 0.1" apart at 45°.

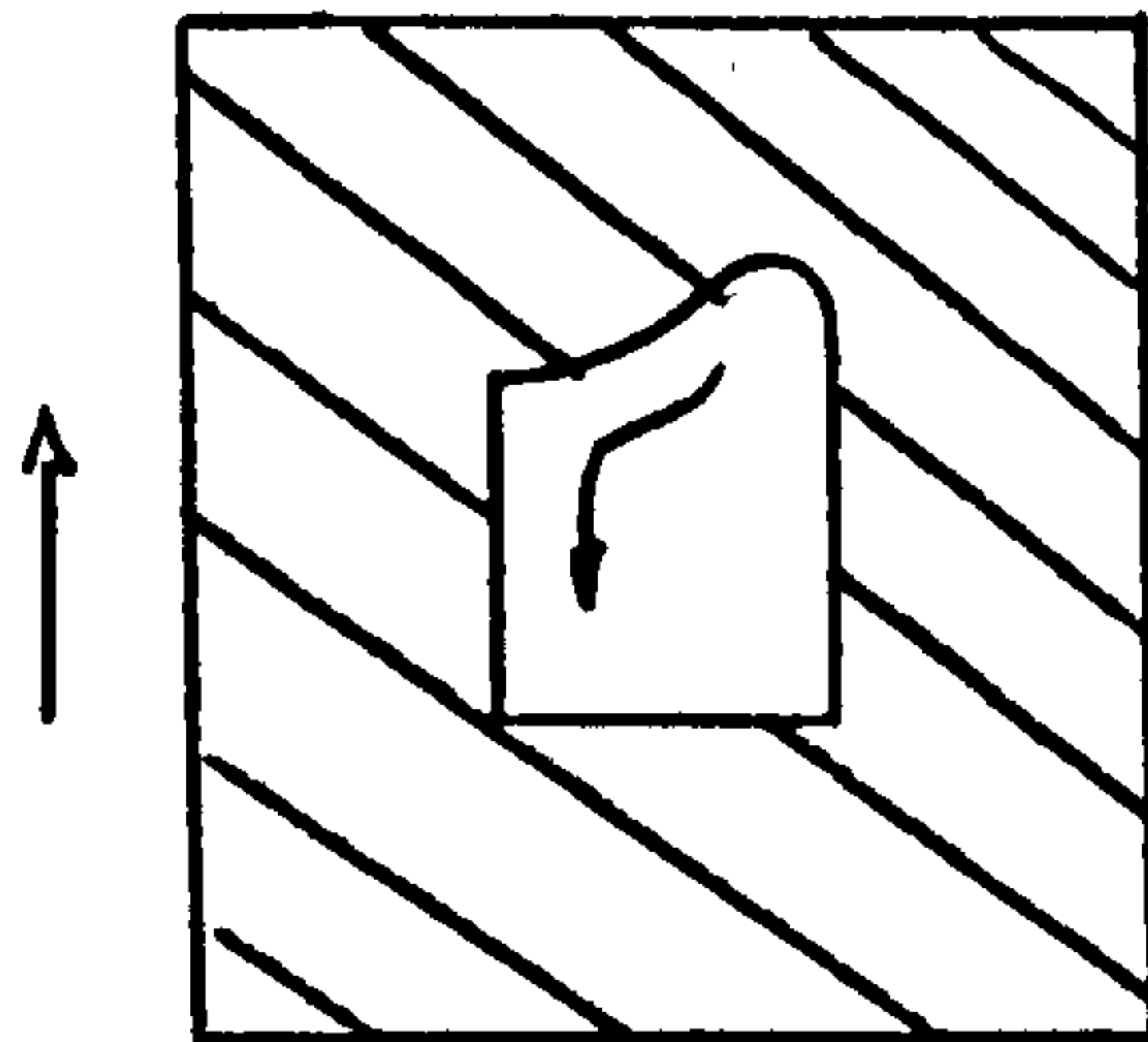

NOTES 1. A clockwise contour is assumed to be solid whilst in anti-clockwise contour creates a hole.

(1)26.03.75

NAME        SHAPE

FUNCTION    Reads a 2-dimensional *Picasso* shape from punched cards and stores it in a real array.

ARGUMENT    (*ARRAY*)

*ARRAY*    (Real array) accepts the 2-d *Picasso* shape

EXAMPLE    *CALL SHAPE(STARS)*

            This statement reads in the next *Picasso* shape and stores it in the array *Stars*.

NOTES

1. The array must be declared on a dimension statement and must be large enough to store the entire shape.
2. No plotting takes place.

NAME      SHIFT

FUNCTION Alters the location of a 2-dimensional *Picaso* shape

ARGUMENTS (*ARRAY, X, Y*)

*ARRAY* (Real array) stores a 2-d *Picaso* shape

*X, Y* (Real inches) is the degree of shift

EXAMPLE *CALL SHIFT(BOX, 3.0, 1.0)*

This statement shifts the coordinates stored  
in *Box*, 3.0 inches along the X-axis and 1.0  
inch along the Y-axis

NOTES 1. No plotting takes place

NAME       SHIFT3 (Shift 3-d)

FUNCTION   Alters the location of a 3-d *Picasso* object

ARGUMENTS  (*ARRAY, X, Y, Z*)

*ARRAY*   (Real array) stores a 3-d *Picasso* object

*X, Y, Z*   (Real inches) is the degree of shift

EXAMPLE    *CALL SHIFT3(BOX, 1.0, 1.0, 1.0)*

            This statement adds 1.0 inch to every  
            coordinate of *box*.

NOTES       1. No plotting takes place

NAME SILUET (Silhouette)

FUNCTION Draws out a tiled version of a 2-d contour rotated about an axis

ARGUMENTS (*ARRAY, SIZE, X, Y, Z, ANGS, ANGF, N, L*)

*ARRAY* (Real array) stores a 2-d *Picasso* open contour

*SIZE* (Real) alters the size of the drawing

*X, Y, Z* (Real) is the amount of shift applied to the object

*ANGS* (Real degrees) is the starting angle of rotation

*ANGF* (Real degrees) is the final angle of rotation

*N* (Integer) is the number of rotational steps

*L* (Integer) if *L* is -VE a degree of hidden-line removal is included. If *L* is +VE all lines are drawn

EXAMPLE *CALL SILUET(A, 1.0, 0.0, 0.0, 0.0, 0.0, 0.0, 360.0, 20, 1)*

This statement draws out a complete rotation of the contour stored in *A*.

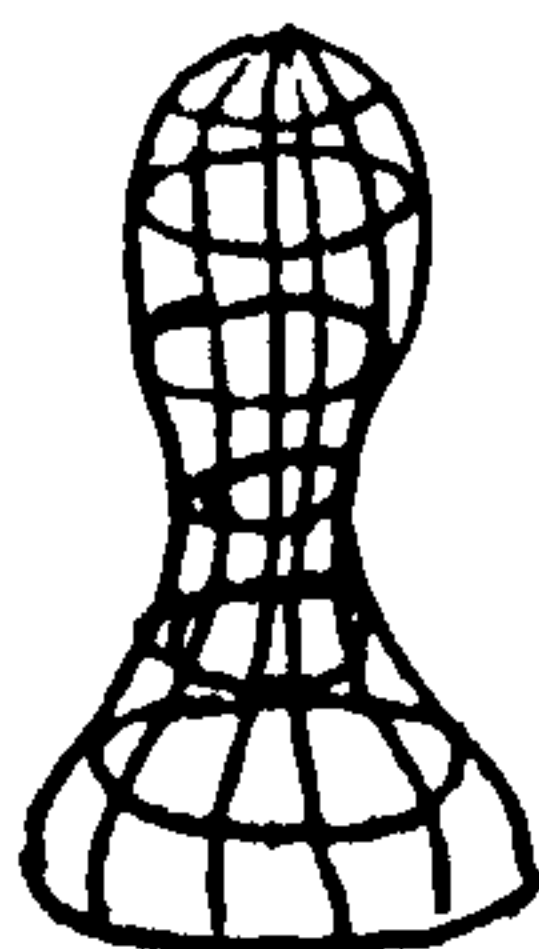

NOTES 1. The position of the eye must be specified by calling *eye* or *fishi*

NAME SINE (Sine wave)

FUNCTION Stores a sine wave in an array

ARGUMENTS (*ARRAY, AMP, LENGTH, ANGS, ANGF, N, XP, YP*)

*ARRAY* (Real array) stores the 2-d *Picasso* sine wave

*AMP* (Real inches) the amplitude of the sine wave

*LENGTH* (Real inches) the length of the waveform

*ANGS* (Real degrees) the starting angle of the waveform

*ANGF* (Real degrees) the final angle of the waveform

*N* (Integer) number of steps in waveform

*XP, YP* (Real inches) the coordinate of the first point

EXAMPLE *CALL SINE(S, 1.0, 2.0, 0.0, 180.0, 20, 0.0, 0.0)*

This statement stores a waveform consisting of a half-sine wave in *S*.

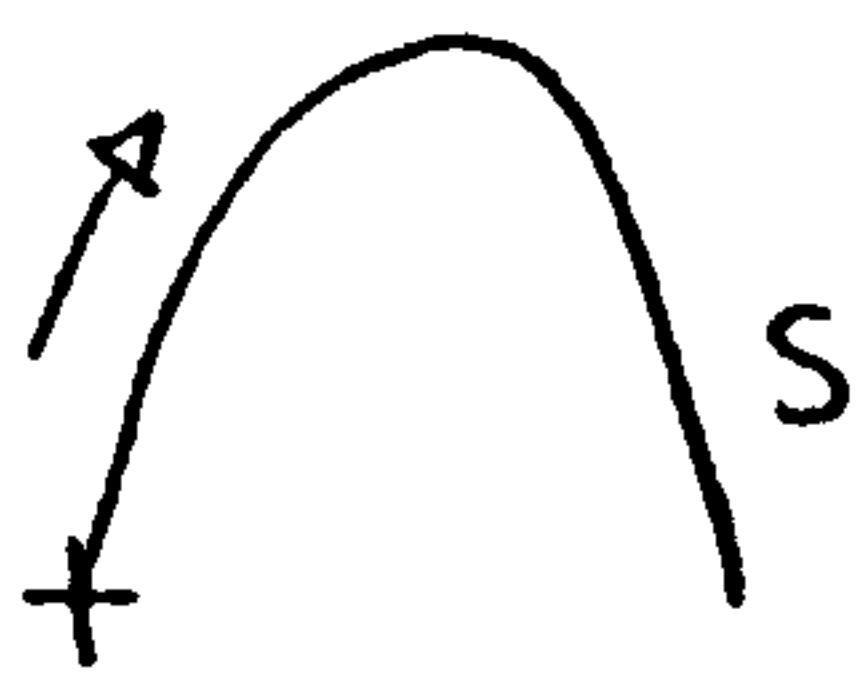

NOTES 1. No plotting takes place

## PICASO SYSTEM

## SIZE

NAME            SIZE

FUNCTION       Changes the size of a 2-dimensional *Picaso* shape

ARGUMENTS     (*ARRAY,F,X,Y*)

*ARRAY*        (Real array) stores a 2-d *Picaso* shape

*F*             (Real) is the size change factor

*X,Y*          (Real inches) is the centre of the size  
change

EXAMPLE       *CALL SIZE(BOX,3.0,1.0,1.0)*

This statement modifies the shape coordinates stored in *box* by a factor of 3.0 relative to the point (1.0,1.0). For example, the point (2.0,2.0) becomes (4.0,4.0)

NOTES         1. No plotting takes place

NAME       SMOOTH

FUNCTION   Draws a smooth curve (Cubic Spline) through a given set of data points stored as a 2-d *Picaso* shape

ARGUMENTS (*ARRAY, SIZE, X, Y, WARRAY*)

*ARRAY*    (Real array) stores a 2-d *Picaso* shape

*SIZE*     (Real) alters the size of the drawn shape by a factor of 'size'.

*X, Y*     (Real inches) is the degree of shift applied to the shape

*WARRAY*  (Real array) is a work array required by smooth. It has dimensions (5,N) where N is equal to the number of vertices in any contour of the shape

EXAMPLE    *CALL SMOOTH(A, 1.0, 0.0, 0.0, W)*

This statement draws a curve through the shape stored in *A*.

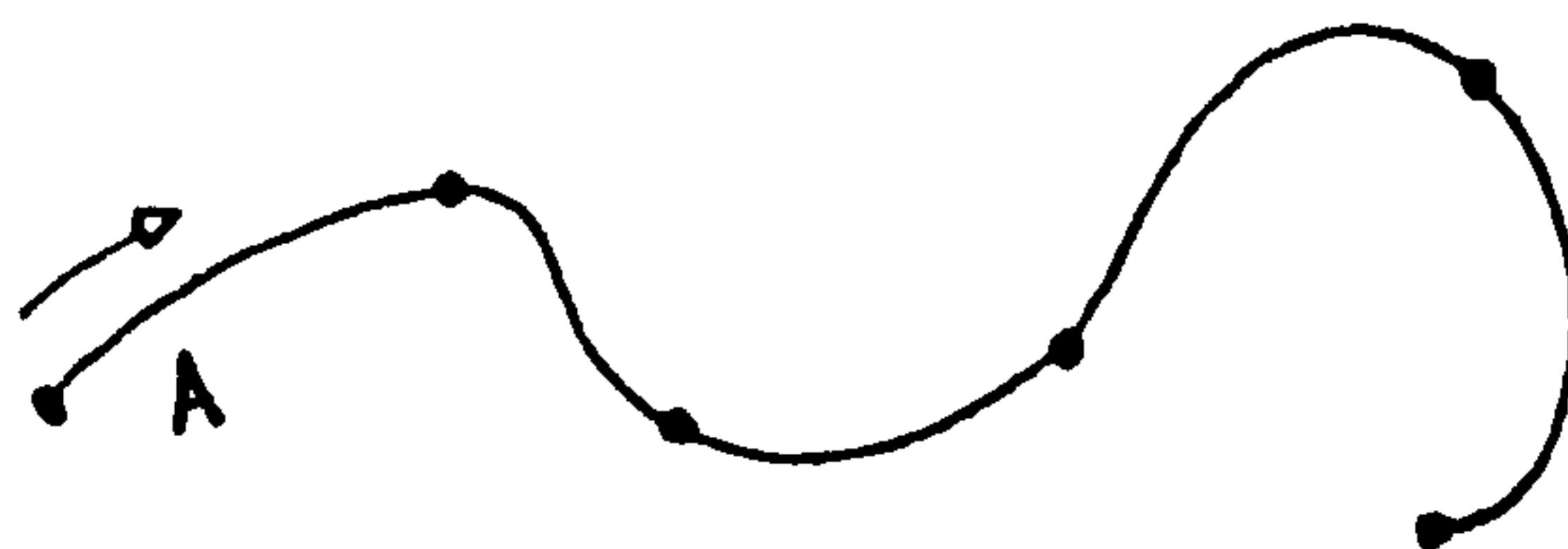



NAME SLOPE

FUNCTION Calculates the slope in degrees of a 2-d *Picasso* shape

ARGUMENTS (*ARRAY, NC, NL*)

*ARRAY* (Real array) stores a 2-d *Picasso* shape

*NC* (Integer) references the contour

*NL* (Integer) references the line

EXAMPLE  $A = \text{SLOPE}(\text{BOX}, 1, 2)$

This statement calculates the angle of the *second* line on the *first* contour of *box*.



- NOTES
1. Slope is a real function
  2. If a contour has  $N$  vertices, then there are  $N-1$  lines

NAME SNOW (Snowflake Curve)

FUNCTION Develops a snowflake curve from a 2-d *Picasso* shape

ARGUMENTS (*ARRAY, XO, YO, F, DEPTH*)

*ARRAY* (Real array) stores the 2-d *Picasso* shape to be transformed

*XO, YO* (Real inches) is the degree of shift to be applied to the final shape

*F* (Real) is the degree of enlargement or reduction of the drawn shape relative to the original stored in array

*DEPTH* (Real) is the degree of crystallisation

EXAMPLE *CALL SNOW(F, 0.0, 0.0, 1.0, 3)*

This statement crystallises the shape *F* to a depth of 3 with zero shift and no size change

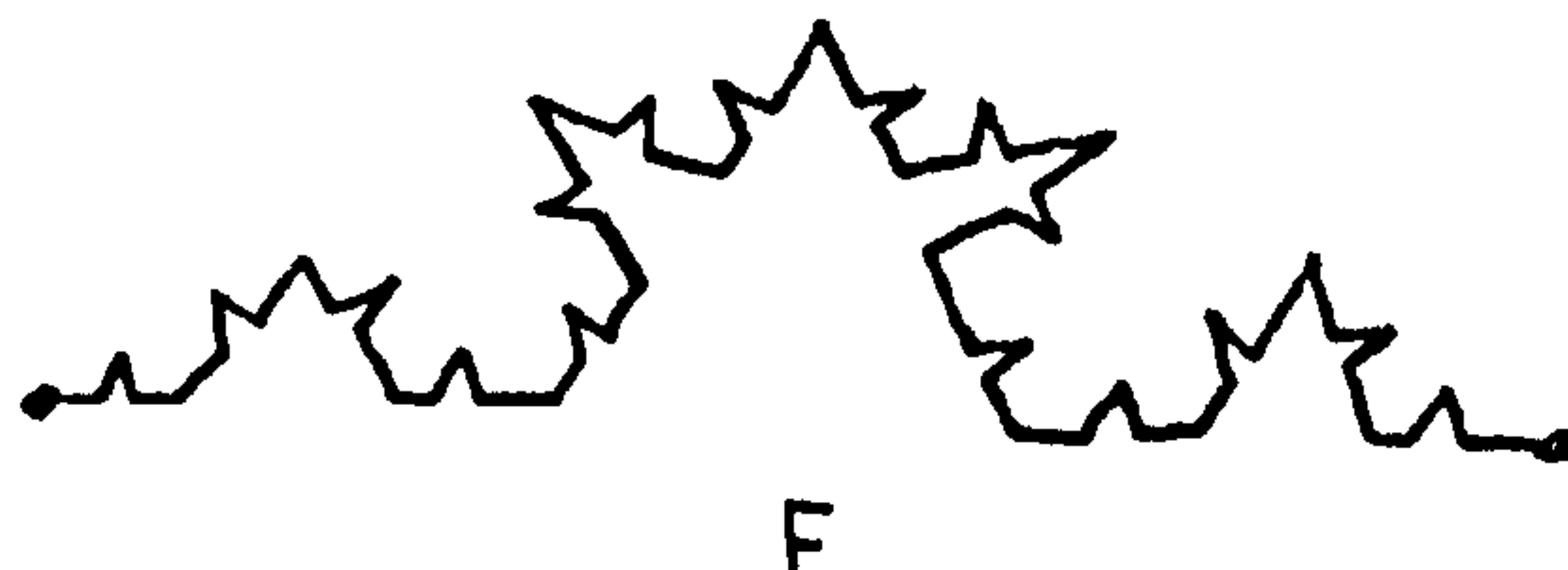

- NOTES
1. Plotting does take place
  2. Depth should not exceed 4
  3. Clockwise shapes grow, anti-clockwise reduce

NAME        SQUARE

FUNCTION   Stores a square as a 2-dimensional *Picasso* shape

ARGUMENTS (*ARRAY, SIDE*)

*ARRAY*    (Real array) stores the square

*SIDE*     (Real inches) is the size of the square

EXAMPLE    *CALL SQUARE(S,1.0)*

This statement stores a square with sides 1.0 inch long, and the lower left-hand corner at the origin.

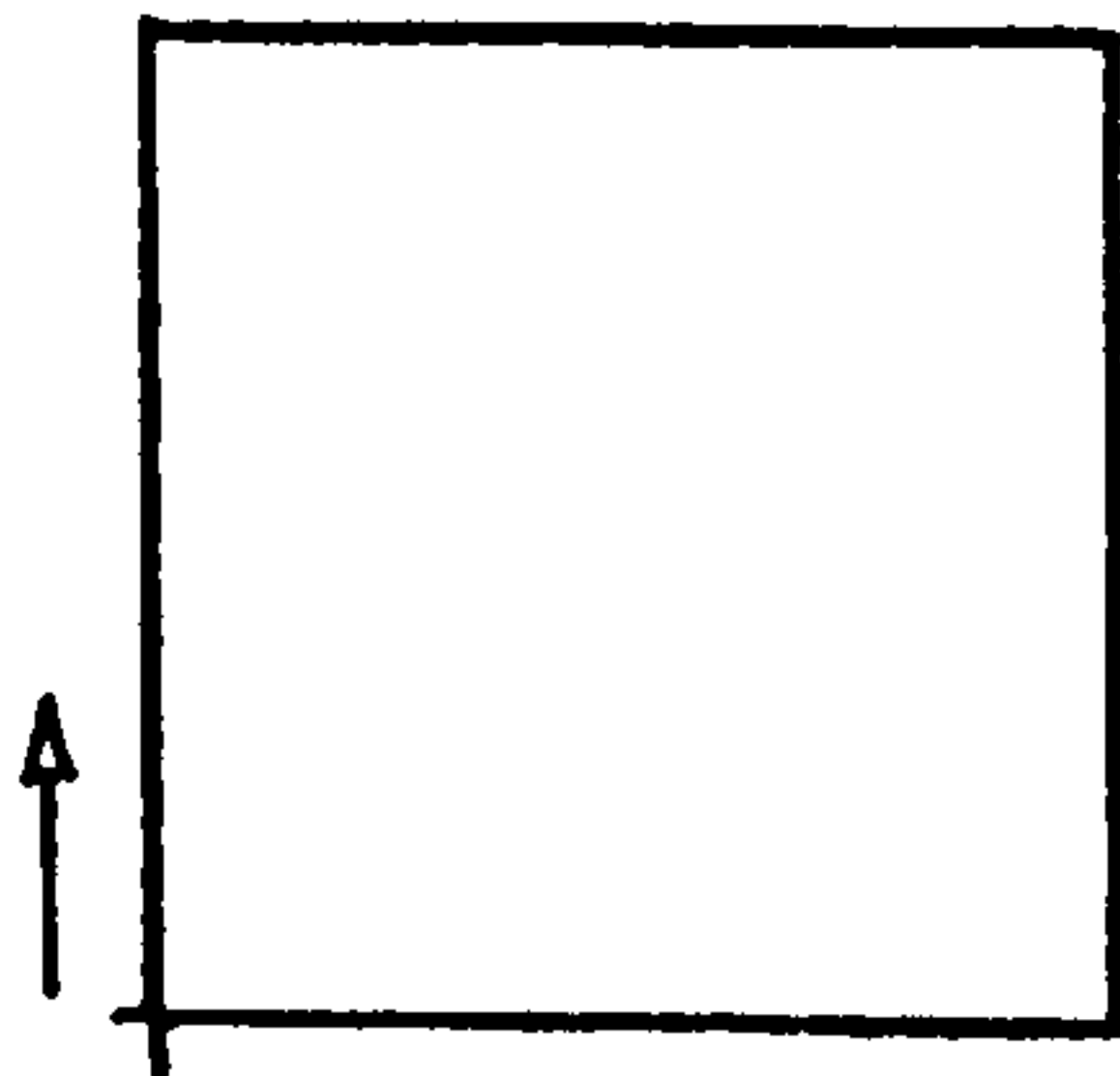

NOTES

1. No plotting takes place
2. The first point is the origin
3. Coordinates are in clockwise sequence
4. The array must be dimensioned to at least 13.

NAME STAR

FUNCTION Stores a regular star as a 2-d *Picasso* shape

ARGUMENTS (*ARRAY, NP, RADOUT, RADIN*)

*ARRAY* (Real array) stores the 2-d *Picasso* star

*NP* (Integer) is the number of points to the star

*RADOUT* (Real inches) is the radius of the outer point  
point

*RADIN* (Real inches) is the radius of the inner point

EXAMPLE *CALL STAR(S, 4, 2.0, 1.0)*

This statement stores a 4-pointed star in *S*.

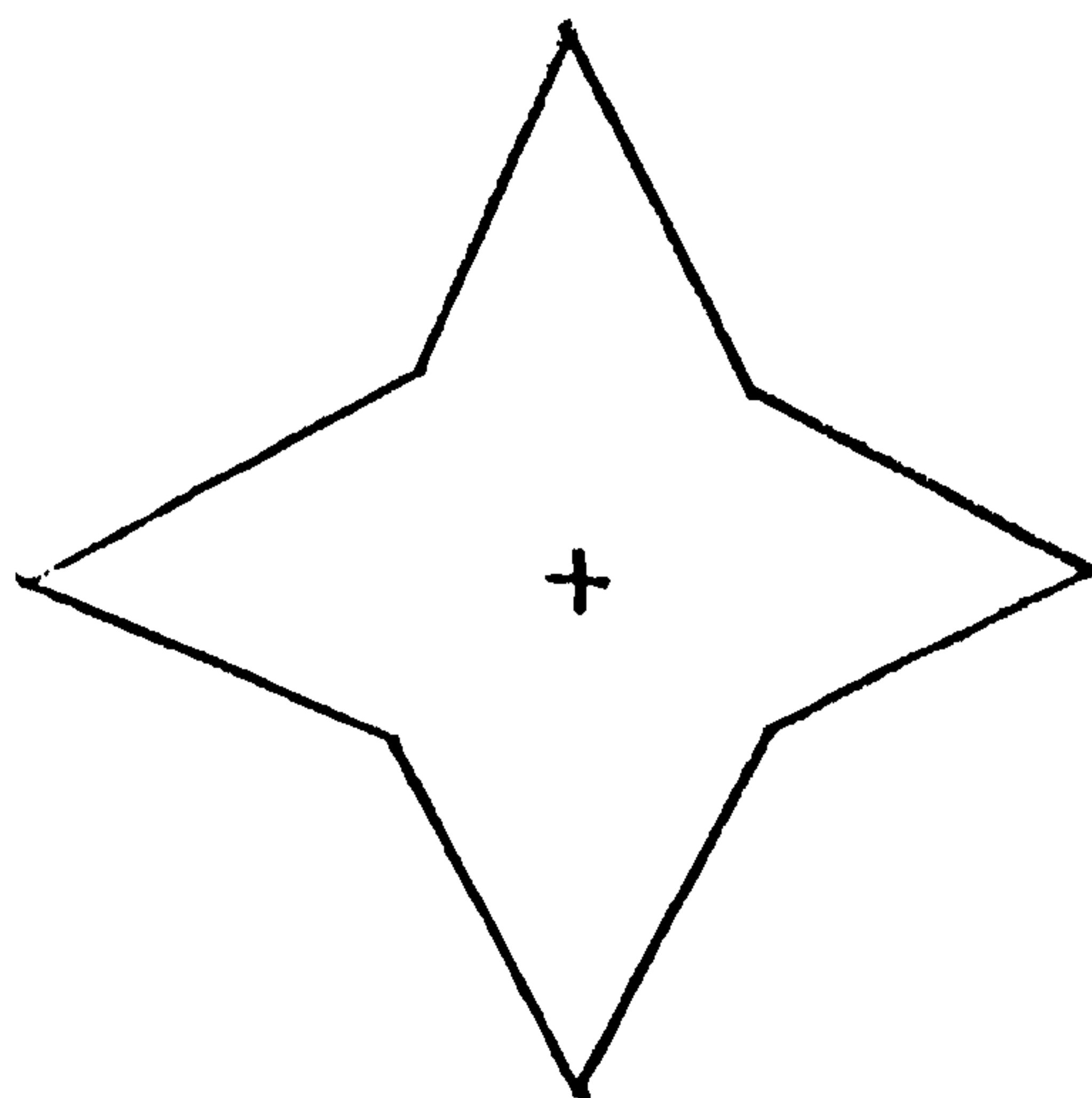

NOTES

1. No plotting takes place
2. If there are  $N$  points to a star then there will be  $2*N+1$  vertices. This implies that the array must be dimensioned at least  $4*N+5$ .

PICASO SYSTEM

START

NAME        START

FUNCTION   Initialises all plotting processes

ARGUMENTS   None

EXAMPLE     *CALL START*

              This statement enables all plotting commands  
              to function

NOTES        1. It is only necessary to call start before plotting

NAME        STICK

FUNCTION    Takes two 2-dimensional *Picasso* shapes and adjusts the coordinates of the second shape such that its first point is coincident with the last point of the first shape

ARGUMENTS  (*ARRAYA, ARRAYB, ARRAYC*)

*ARRAYA*    (Real array) stores a 2-d *Picasso* shape

*ARRAYB*    (Real array) stores a 2-d *Picasso* shape

*ARRAYC*    (Real array) receives the two shapes connected together

EXAMPLE    *CALL STICK(A, B, C)*

This statement connects shape *B* to shape *A* and stores the result in *C*.



#### NOTES

1. No plotting takes place
2. Arraya may be a complex shape but only the first line is used
3. Arrayb must only contain one line
4. Arrayc will store arraya followed by arrayb
5. Arrayc must be large enough to contain arraya and arrayb.

NAME            STIPLE (Stipple)

FUNCTION       Draws a random pattern of dots within a given shape

ARGUMENTS     (*ARRAY,N*)

*ARRAY*        (Real array) stores a 2-d *Picasso* shape

*N*             (Integer) is the number of dots to draw

EXAMPLE       *CALL STIPLE(B,100)*

               This statement draws 100 dots inside the  
               shape *B*.

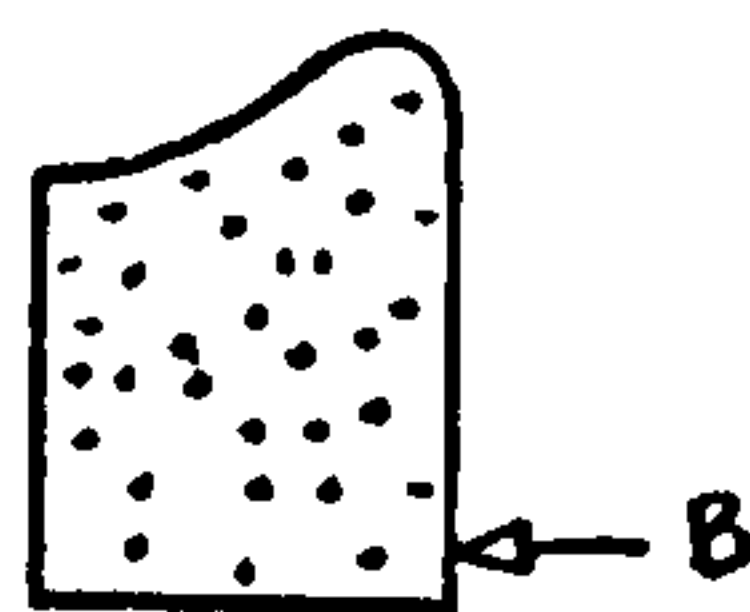

NOTES          1. The shape in 'B' is not drawn

**NAME** Surfac (Surface)

**FUNCTION** Creates a three-dimensional surface by rotating a two-dimensional contour about an axis

**ARGUMENTS** (*ARRAY, LX, NX, LY, NY, ANGLE, XC, YC, WARRAY, OVER, UNDER, XS, YS*)

*ARRAY* (Real array) stores a 2-d *Picasso* open contour

*LX* (Real inches) is the width of the surface

*NX* (Integer) is the number of points across the surface

*LY* (Real inches) is the depth of the surface

*NY* (Integer) is the number of lines creating the surface

*ANGLE* (Real degrees) is the angle the surface makes with the X-Z plane

*XC, YC* (Real inches) are the coordinates of the axis about which rotation occurs

*WARRAY* (Real array) is a work array required by *surfac* and must be dimensioned (*NX*)

*OVER* (Real array) is a work array required by *surfac* to maintain the upper horizon and must be dimensioned (*NX*)

*UNDER* (Real array) is a work array required by *surfac* to maintain the lower horizon and must be dimensioned (*NX*)

*XS, YS* (Real inches) is the degree of shift applied to the entire surface relative to the origin

**EXAMPLE** *CALL SURFAC(C, 6.0, 50, 6.0, 50, 30.0, 3.0, 3.0, ARRAY, OVER, UNDER, 0.0, 0.0)*  
 This statement rotates a contour stored in *C* about the point (3.0, 3.0) and draws a non-transparent surface



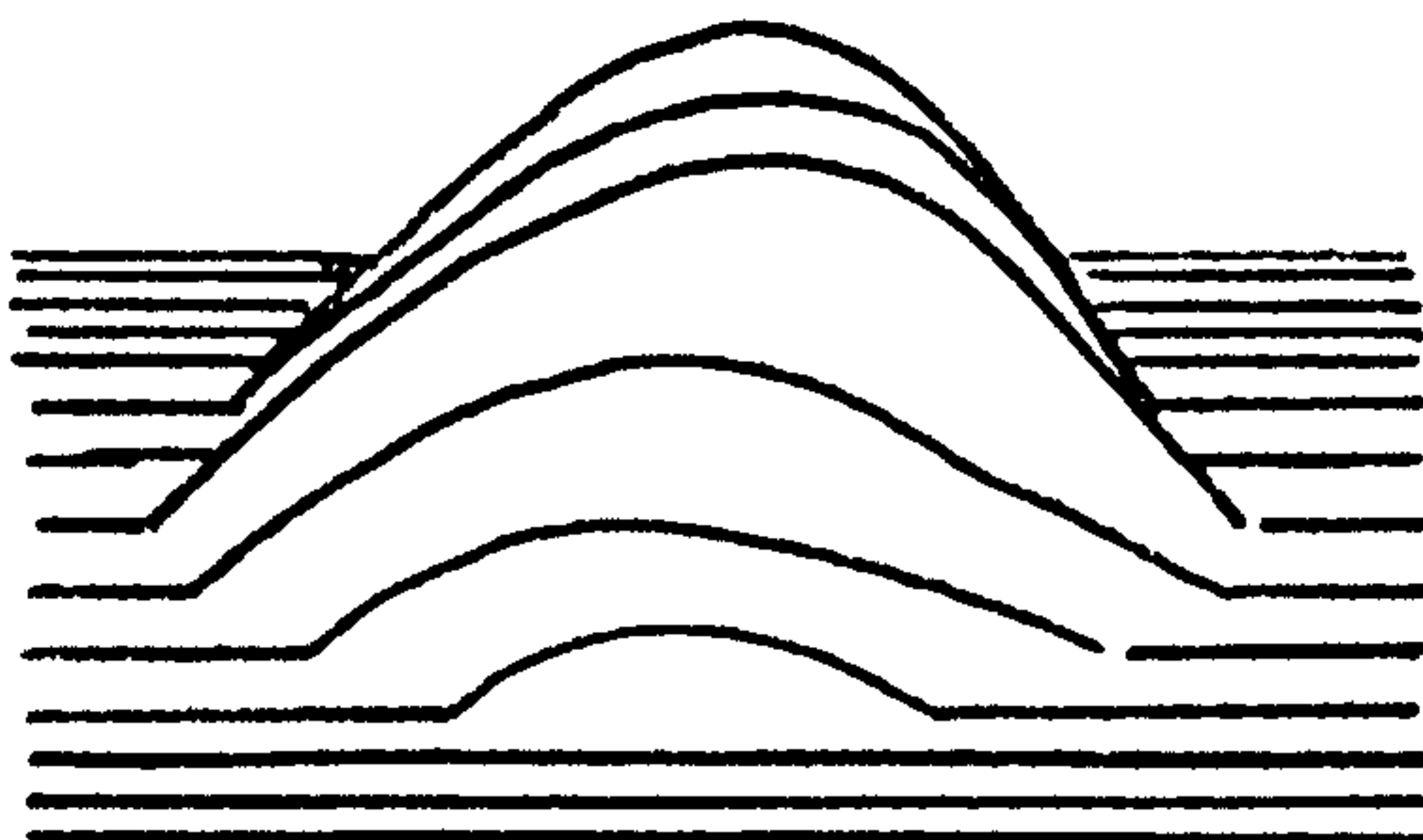

NOTES

1. The following diagram illustrates the significance of the arguments:

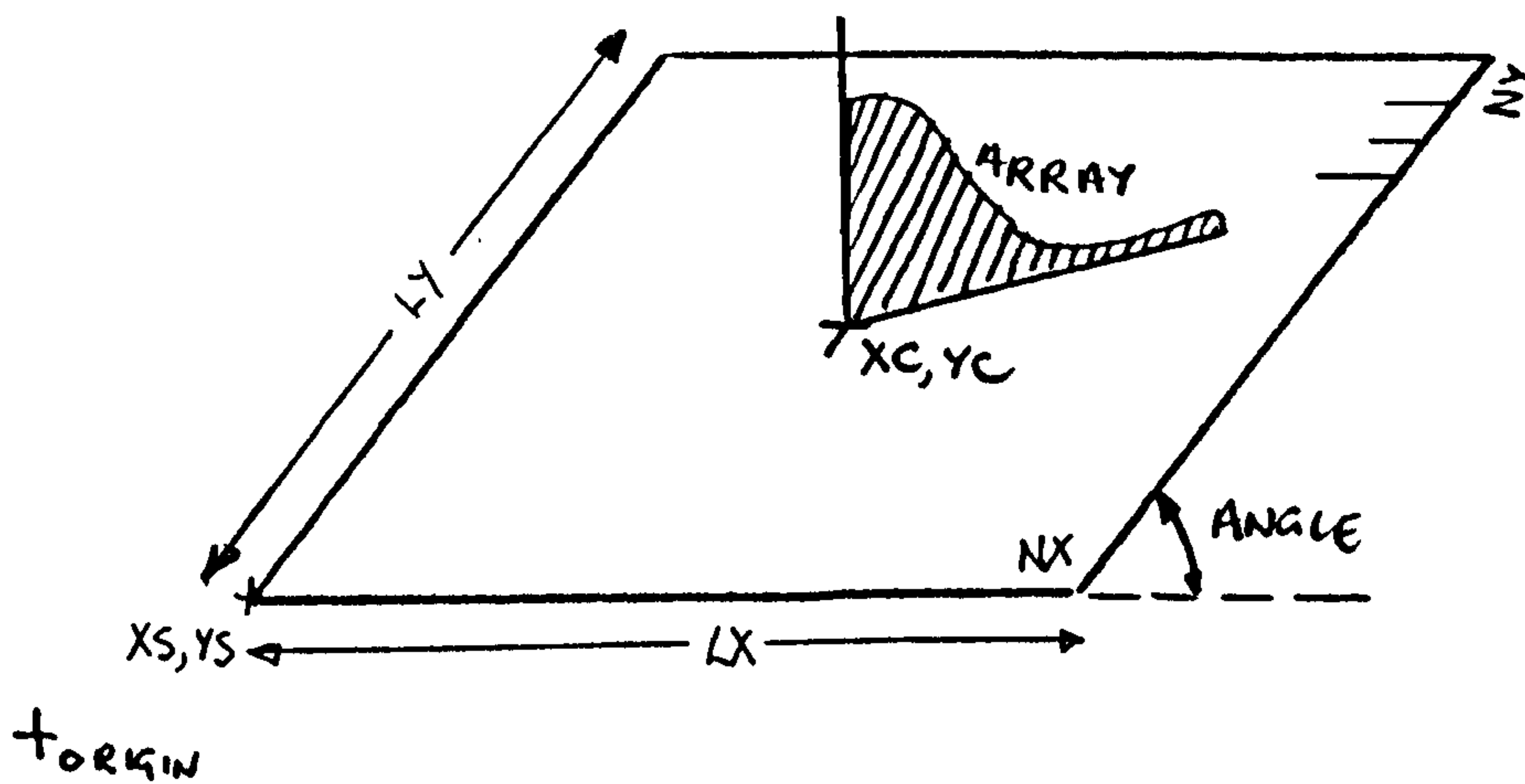

NAME TAKE (Choose a real random number)

FUNCTION Chooses a random number from a specified range

ARGUMENTS (A,B)

A (Real) defines low-order range

B (Real) defines high-order range

EXAMPLE *X=TAKE(-2.0,10.0)*

This statement sets X a random number between  
the range -2.0 to 10.0 inclusive

NAME TRACE

FUNCTION Traces around a 2-d *Picasso* shape a given distance

ARGUMENTS (*ARRAY, DIST, ARRAYA*)

*ARRAY* (Real array) stores a 2-d *Picasso* shape

*DIST* (Real inches) is the tracing distance

*ARRAYA* (Real array) receives the traced shape

EXAMPLE *CALL TRACE(A, 0.2, B)*

This statement traces 0.2" away from *A* and stores the shape in *B*.

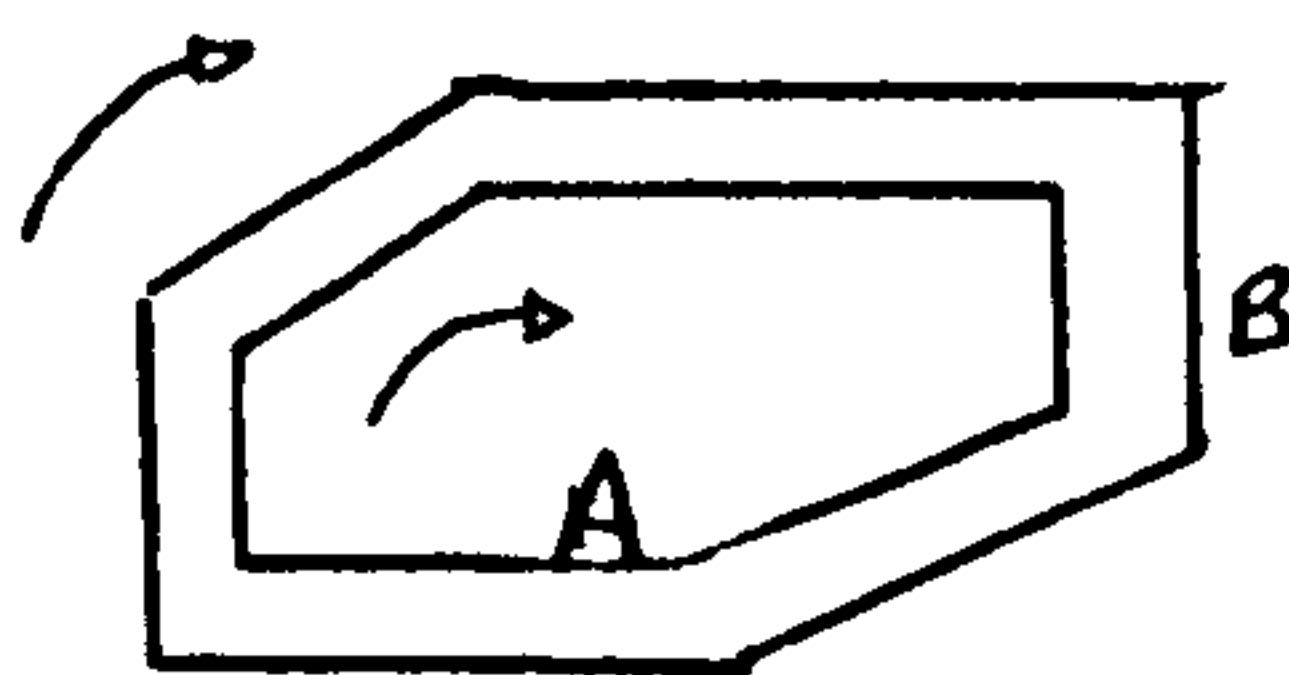

*CALL TRACE (C, 0.2, D)*

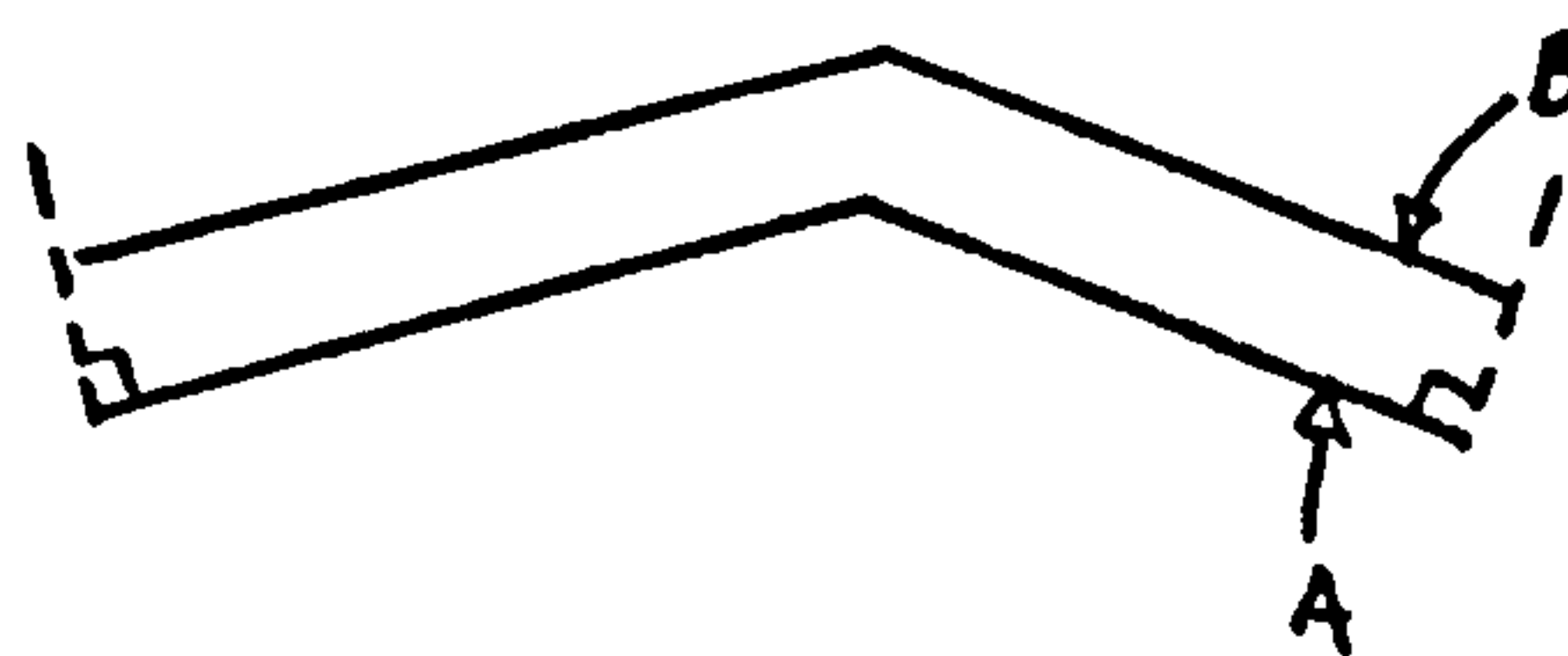

NOTES

1. No plotting takes place
2. Open contours are treated as illustrated above

NAME       TRANSH (Transform shapes)

FUNCTION   Transforms one 2-dimensional shape into another in a given number of steps

ARGUMENTS  (*ARRAYA, LA, ARRAYB, LB, ARRAYC, F*)

*ARRAYA*   (Real array) stores the 2-d *Picasso* shape to be transformed

*LA*       (Integer) references the contour on *Arraya* that is transformed

*ARRAYB*   (Real array) stores the 2-d *Picasso* shape guiding the transformation

*LB*       (Integer) references the contour on *Arrayb* that guides the transformation

*ARRAYC*   (Real array) stores the transformed shape

*F*         (Real) is the degree of transformation

EXAMPLE    *CALL TRANSH(A,1,B,1,C,0.5)*

This statement transforms the *first* contour of *A* into the *first* contour of *B* by 50% and stores it in *C*.



NOTES      1. No plotting takes place

NAME        TRANSP (Transpose)

FUNCTION    Transposes a 2-d *Picasso* shape into a 3-d  
            object

ARGUMENTS  (*ARRAY,ARRAYA*)

*ARRAY*    (Real array) stores a 2-d *Picasso* shape

*ARRAYA* (Real array) receives the 3-d *Picasso* shape

EXAMPLE    *CALL TRANSP(A,B)*

            This statement transposes the 2-d shape in *A*,  
            into a 3-d object by including a Z coordinate  
            set to 0.0 and stores it in *B*.

NAME        TURN3D (Turn in 3 dimensions)

FUNCTION    Turns a 3-d *Picasso* object about one axis

ARGUMENTS  (*ARRAY, THETA, CH, CV, N, ARRAYA*)

*ARRAY*     (Real array) stores a 3-d *Picasso* object

*THETA*     (Real degrees) is the angular rotation

*CH, CV*     (Real) are the coordinates of the rotational  
              centre

*N*            (Integer) references the axis unrotated,  
               $X \equiv 1$ ,  $Y \equiv 2$  &  $Z \equiv 3$

*ARRAYA*    (Real array) receives the rotated object

EXAMPLE    *CALL TURN3D(B, 20.0, 0.0, 0.0, 1, C)*

This statement rotates 'B' about the X axis  
and the result in C.

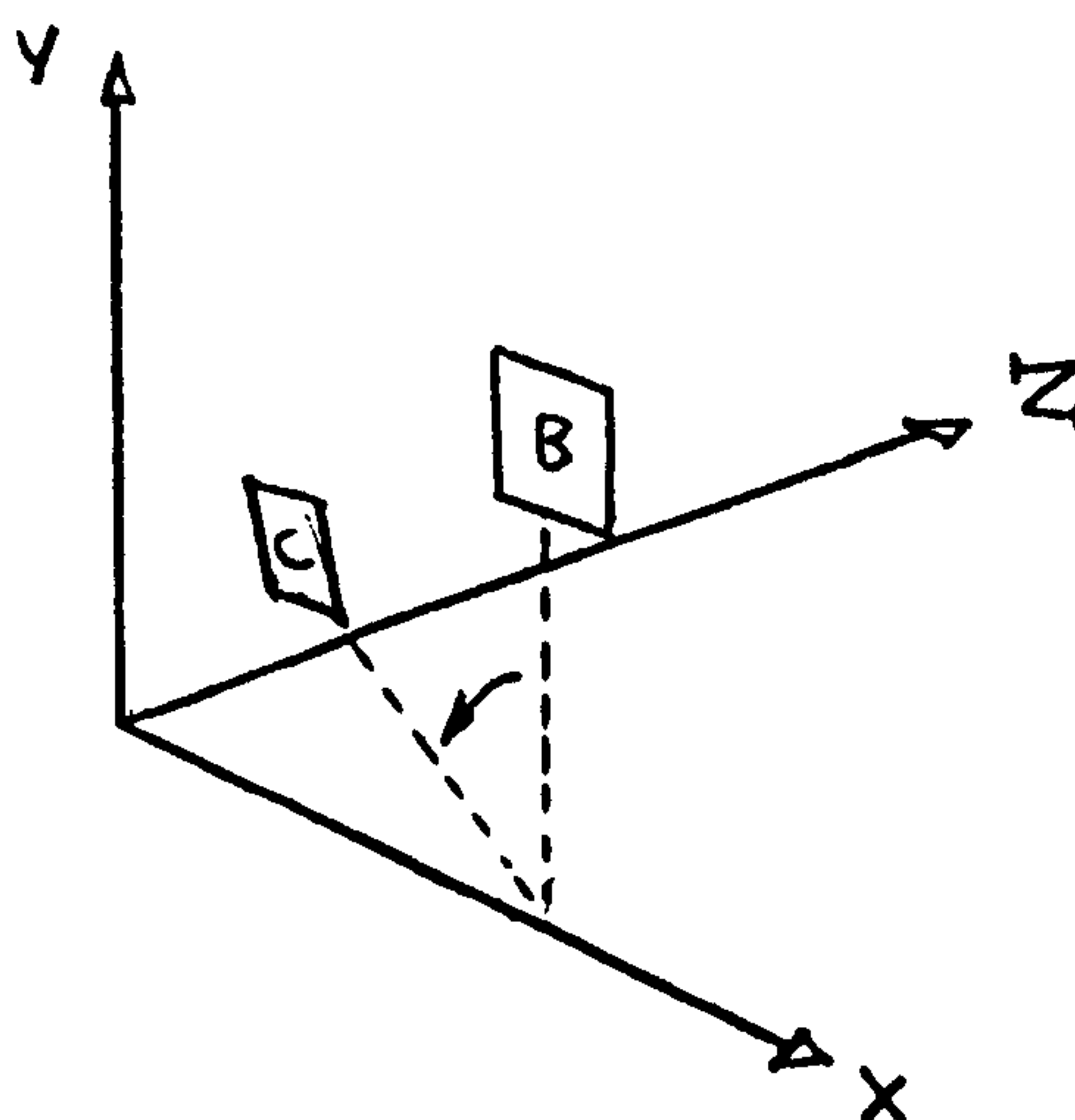

NOTES        1. No plotting takes place

NAME WINDOW

FUNCTION Establishes a boundary to confine plotting to occur only within a specified shape

ARGUMENTS (ARRAY)

ARRAY (Real array) stores a 2-d *Picasso* shape

EXAMPLE *CALL WINDOW(A)*

This statement arranges the shape stored in *A* to window all future plotting. If '*A*' stores a hexagon the following could result

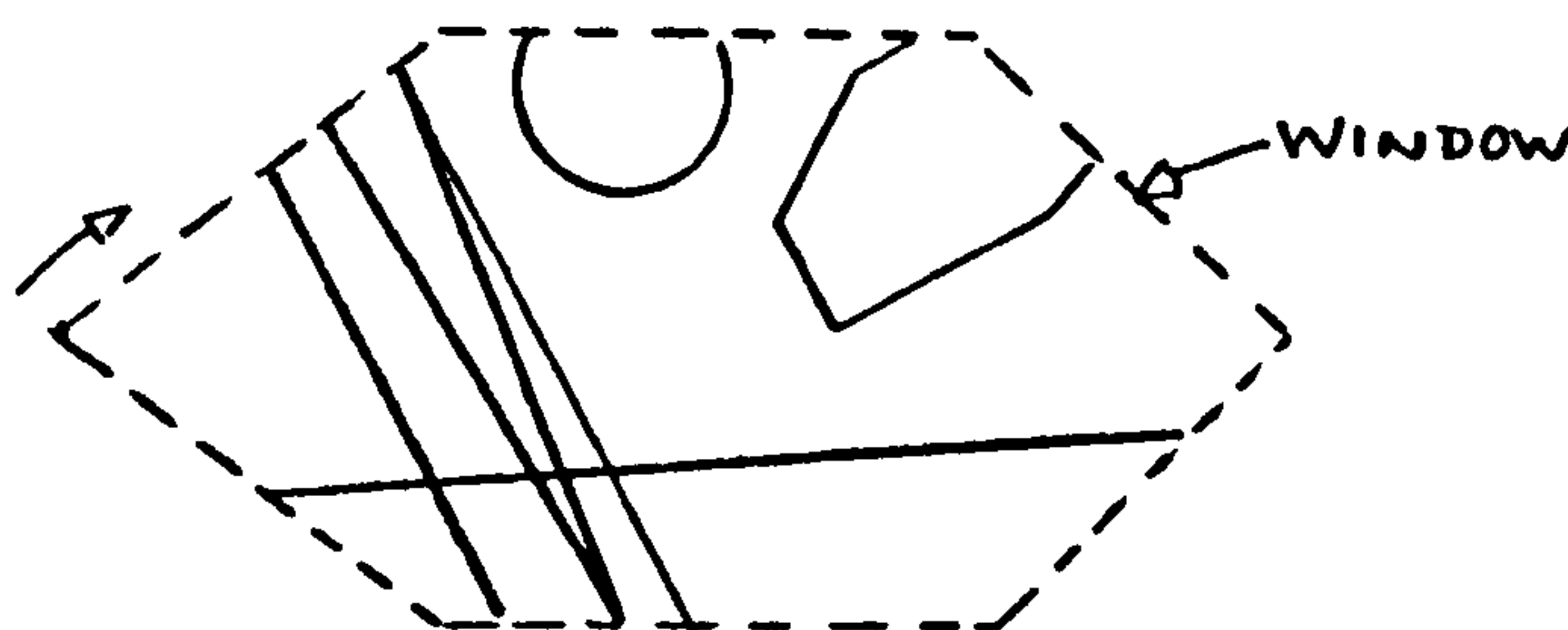

#### NOTES

1. The window shape is not drawn
2. The windowing is canceled by calling *call window (0.0)*
3. The origin of the window coincides with the plotting origin
4. Clockwise window contours create holes anti-clockwise window contours mask
5. A window shape may have many contours so long as any line drawn does not intersect with more than 10 lines
6. The window shape cannot be drawn whilst windowing occurs

**NAME** XARC (X-coordinate of an Arc)

**FUNCTION** Returns the X-coordinate of a point on an Arc

**ARGUMENTS** (*X, Y, RADIUS, THETA, PHI, I, N*)

*X, Y* (Real inches) are the coordinates of the centre of revolution

*RADIUS* (Real inches) is the radius of curvature

*THETA* (Real degrees) is the starting angle of the arc

*PHI* (Real degrees) is the swept angle in a clockwise direction

*I* (Integer) is the position on the curve relative to *N*.

*N* (Integer) is the number of points on the curve.

**EXAMPLE**  $X = \text{XARC}(0.0, 0.0, 2.0, 180.0, 90.0, 2, 100)$

This statement sets *X* to the X-coordinate of the 2nd of an arc consisting of 100 points



**NOTES** 1. No plotting takes place



NAME XCOORD (X coordinate)

FUNCTION Is a function returning the X coordinate of a specified point in a *Picasso* structure

ARGUMENTS (*ARRAY,NL,NP*)

*ARRAY* (Real array) stores a *Picasso* structure

*NL* (Integer) references the contour or surface containing the point

*NP* (Integer) references the point

EXAMPLE *X=XCOORD(BOX,1,1)*

This statement returns the X coordinate of the first point on the *first* contour of *box*.

NOTES

1. No plotting takes place
2. Xcoord is a real type function

**NAME** XELLIP (X coordinate of an ellipse)

**FUNCTION** Returns the X-coordinate of a specific point on an ellipse

**ARGUMENTS** (MAJOR, MINOR, I, N)

*MAJOR* (Real inches) is the major radius of the ellipse.

*MINOR* (Real inches) is the minor radius of the ellipse

*I* (Integer) is the number of the point on the ellipse

*N* (Integer) is the maximum number of points on the curve

**EXAMPLE** *C=XELLIP(3.0,2.0,20,100)*

This statement sets C to the 20th X-coordinate of an ellipse containing 100 points

**NOTES**

1. No plotting takes place
2. The curve is clockwise

**NAME** XEPIT (X-coordinate of an epitrochoid)

**FUNCTION** Returns the X-coordinate of a specific point on an epitrochoid

**ARGUMENTS** (*RADFIX*, *RADMOV*, *DIST*, *I*, *N*)

*RADFIX* (Real inches) is the radius of the fixed circle

*RADMOV* (Real inches) is the radius of the moving circle

*DIST* (Real inches) is the distance of the traced point that exists on the moving circle to its centre

*I* (Integer) is the number of the point on the curve

*N* (Integer) is the maximum number of points on the curve

**EXAMPLE** *C=XEPIT(3.0,1.0,0.5,20,100)*

This statement sets C to the 20th X-coordinate of an epitrochoid containing 100 points

**NOTES**

1. No plotting takes place
2. The curve is clockwise

**NAME** XHYPER (X-coordinate of a hyperbola)

**FUNCTION** Returns the X-coordinate of a specific point on a hyperbola

**ARGUMENTS** (*SPAN, DIST, I, N*)

*SPAN* (Real inches) is the width and height of the curve relative to the X & Y axes

*DIST* (Real inches) is the distance of the curve from the X or Y axis at the limits of the curve

*I* (Integer) is the number of the point on the curve

*N* (Integer) is the maximum number of points on the curve

**EXAMPLE** *C=XHYPER(2.0,0.5,20,100)*

This statement sets C to the 20th X-coordinate of a hyperbola consisting of 100 points

**NOTES** 1. No plotting takes place

**NAME** XHYPOT (X-coordinate of a hypotrochoid)

**FUNCTION** Returns the X-coordinate of a specific point on a hypotrochoid

**ARGUMENTS** (*RADFIX, RADMOV, DIST, I, N*)

*RADFIX* (Real inches) is the radius of the fixed circle

*RADMOV* (Real inches) is the radius of the moving circle

*DIST* (Real inches) is the distance of the traced point on the moving circle to its centre

*I* (Integer) is the number of the point on the curve

*N* (Integer) is the maximum number of points on the curve

**EXAMPLE** *C=XHYPOT(3.0,1.0,0.5,20,100)*

This statement sets C to the 20th X-coordinate of a hypotrochoid consisting of 100 points

**NOTES**

1. No plotting takes place
2. The curve is clockwise

**NAME** XLISS (X-coordinate of a lissajous curve)

**FUNCTION** Returns the X-coordinate of a specific point on a lissajous curve

**ARGUMENTS** (*XSPAN, YSPAN, F, D, I, N*)

*XSPAN* (Real inches) is the width of the curve

*YSPAN* (Real inches) is the height of the curve

*F* (Real) is a factor affecting the number of loops in the 'X' direction

*D* (Real radians) is a displacement value

*I* (Integer) is the number of the point on the curve

*N* (Integer) is the maximum number of points on the curve

**EXAMPLE** *C=XLISS(2.0,2.0,1.0,0.0,20,100)*

This statement sets C to the 20th X-coordinate of a lissajous curve consisting of 100 points

**NOTES**

1. No plotting takes place
2. The curve is clockwise

**NAME** XLSPIR (X-coordinate of a logarithmic spiral)

**FUNCTION** Returns the X-coordinate of a specific point on a logarithmic spiral

**ARGUMENTS** (*RADIUS, CYCLES, I, N*)

*RADIUS* (Real inches) is the final radius of the spiral

*CYCLES* (Real) is the number of cycles in the spiral

*I* (Integer) is the number of the point on the curve

*N* (Integer) is the maximum number of points on the curve

**EXAMPLE** *C=XLSPIR(3.0,2.0,20,100)*

This statement sets C to the 20th X-coordinate of a spiral consisting of 100 points

**NOTES**

1. No plotting takes place
2. The curve is clockwise

NAME XMIRRO (X-coordinate of a mirror-image)

FUNCTION Returns a mirror-image X-coordinate of a given point

ARGUMENTS  $(X, Y, X1, Y1, X2, Y2)$

$X, Y$  (Real inches) are the coordinates of the point to be reflected

$X1, Y1$  (Real inches) are the coordinates of one point on the mirror

$X2, Y2$  (Real inches) are the coordinates of another point on the mirror

EXAMPLE  $C = XMIRRO(1.0, 2.0, 2.0, 0.0, 2.0, 1.0)$

This statement sets C to the X-coordinate of the reflected point 1.0, 2.0

NOTES 1. No plotting takes place



**NAME**           XPARAB (X-coordinate of a parabola)

**FUNCTION**   Returns the X-coordinate of a point on a parabola

**ARGUMENTS**   (*XSPAN*, *YSPAN*, *I*, *N*)

*XSPAN*   (Real inches) is the width of the curve

*YSPAN*   (Real inches) is the height of the curve

*I*       (Integer) is the number of the point on the  
          curve

*N*       (Integer) is the maximum number of points on  
          the curve

**EXAMPLE**     *C=XPARAB(4.0,4.0,20,100)*

          This statement sets C to the X-coordinate of  
          the *20th* point on a parabola consisting of *100*  
          points

**NOTES**       1. No plotting takes place

NAME XPERSP (X-perspective)

FUNCTION Transforms a 3-d point onto a 2-d picture plane

ARGUMENTS  $(X, Y, Z)$

$X, Y, Z$  (Real) are the coordinates of a point in 3-d space

EXAMPLE  $XW = XPERSP(1.0, 1.0, 1.0)$

This statement sets XW to the X-coordinate of the point  $(1.0, 1.0, 1.0)$  on the picture plane

- NOTES
1. The position of the eye must be specified by a call on eye or fishi
  2. Xpersp is a real function

**NAME** XPOLY (X-coordinate of a Polygon)

**FUNCTION** Returns the X-coordinate of a point on a polygon

**ARGUMENTS** (*RADIUS,I,N*)

*RADIUS* (Real inches) is the radius of the polygon

*I* (Integer) is the position on the polygon

*N* (Integer) is the number of points on the polygon

**EXAMPLE** *X=XPOLY(2.0,6,8)*

This statement sets X to the X-coordinate of the 6th point on a polygon consisting of 8 points

**NOTES**

1. No plotting takes place
2. If there are N points on the polygon there are N-1 sides

NAME XROT (X-coordinate rotated)

FUNCTION Returns the X-coordinate of a point rotated theta degrees

ARGUMENTS (*X, Y, XP, YP, THETA*)

*X, Y* (Real inches) are the coordinates of the point to be rotated

*XP, YP* (Real inches) are the coordinates of the centre of rotation

*THETA* (Real degrees) is the angle of rotation  
-VE = clockwise +VE = anti-clockwise

EXAMPLE *X=XROT(1.0,1.0,0.0,0.0,45.0)*

This statement sets X to the X-coordinate of the point (1.0,1.0) rotated about the origin 45.0 degrees

NOTES 1. No plotting takes place

**NAME** XSIN (X-coordinate of a sinewave)

**FUNCTION** Returns the X-coordinate of a sinewave

**ARGUMENTS** (*AMP,WAVE,ANGST,ANGFIN,I,N*)

*AMP* (Real inches) is the amplitude of the sinewave

*WAVE* (Real inches) is the length of the sinewave

*ANGST* (Real degrees) is the starting angle of the sinewave

*ANGFIN* (Real degrees) is the finishing angle of the sinewave

*I* (Integer) is the number of the point on the sinewave relative to *N*

*N* (Integer) is the number of points on the sinewave

**EXAMPLE** *X=XSIN(2.0,4.0,0.0,360.0,20,100)*

This statement sets *X* to the X-coordinate of the *20th* point on a sinewave containing *100* points

**NOTES** 1. No plotting takes place

**NAME** XYZLIN (X,Y or Z-coordinate of a line)

**FUNCTION** Returns the X,Y or Z-coordinate of a point on a line

**ARGUMENTS** (C1,C2,I,N)

*C1* (Real inches) is the X,Y or Z-coordinate of one end of the line

*C2* (Real inches) is the X,Y or Z-coordinate of the other end of the line

*I* (Integer) is the number of the point on the line

*N* (Integer) is the number of points on the line

**EXAMPLE** *Y=XYZLIN(0.0,4.0,20,100)*

This statement sets *Y* to the 20th value between 0.0 and 4.0 when there exists 100 values

**NOTES**

1. No plotting takes place
2. The returned value may be interpreted as an X,Y or Z value

**NAME** YARC (Y-coordinate of an arc)

**FUNCTION** Returns the Y-coordinate of a point on an arc

**ARGUMENTS** (*X,Y,RADIUS,THETA,PHI,I,N*)

*X,Y* (Real inches) are the coordinates of the centre of revolution

*RADIUS* (Real inches) is the radius of curvature

*THETA* (Real degrees) is the starting angle of the arc

*PHI* (Real degrees) is the swept angle in a clockwise direction

*I* (Integer) is the position on the curve relative to *N*

*N* (Integer) is the number of points on the curve

**EXAMPLE** *Y=YARC(0.0,0.0,2.0,180.0,90.0,2,100)*

This statement sets *Y* to the Y-coordinate of the 2nd point of an arc consisting of 100 points

**NOTES** 1. No plotting takes place

NAME YCOORD (Y-coordinate)

FUNCTION Is a function returning the Y-coordinate of a specified point in a *Picasso* structure

ARGUMENTS (*ARRAY, NL, NP*)

*ARRAY* (Real array) stores a *Picasso* structure

*NL* (Integer) references the contour or surface containing the point

*NP* (Integer) references the point

EXAMPLE *Y=YCOORD(BOX,1,1)*

This statement returns the Y - coordinate of the *first* point on the *first* contour of *box*

- NOTES
1. No plotting takes place
  2. Ycoord is a real type function



NAME YELLIP (Y-coordinate of an ellipse)

FUNCTION Returns the Y-coordinate of a specific point on an ellipse

ARGUMENTS (*MAJOR,MINOR,I,N*)

*MAJOR* (Real inches) is the major radius of the ellipse

*MINOR* (Real inches) is the minor radius of the ellipse

*I* (Integer) is the number of the point on the ellipse

*N* (Integer) is the maximum number of points on the curve

EXAMPLE *C=YELLIP(3.0,2.0,20,100)*

This statement sets C to the 20th Y-coordinate of an ellipse containing 100 points

NOTES 1. No plotting takes place  
2. The curve is clockwise

**NAME** YEPIT (Y-coordinate of an epitrochoid)

**FUNCTION** Returns the Y-coordinate of a specific point on an epitrochoid

**ARGUMENTS** (*RADFIX, RADMOV, DIST, I, N*)

*RADFIX* (Real inches) is the radius of the fixed circle

*RADMOV* (Real inches) is the radius of the moving circle

*DIST* (Real inches) is the distance of the traced point that exists on the moving circle to its centre

*I* (Integer) is the number of the point on the curve

*N* (Integer) is the maximum number of points on the curve

**EXAMPLE** *C=YEPIT(3.0,1.0,0.5,20,100)*

This statement sets C to the 20th Y-coordinate of an epitrochoid containing 100 points

**NOTES**

1. No plotting takes place
2. The curve is clockwise

**NAME** YHYPER (Y-coordinate of a hyperbola)

**FUNCTION** Returns the Y-coordinate of a specific point on a hyperbola

**ARGUMENTS** (*SPAN, DIST, I, N*)

*SPAN* (Real inches) is the width and height of the curve relative to the X and Y axes

*DIST* (Real inches) is the distance of the curve from the X or Y axis at the limits of the curve

*I* (Integer) is the number of the point on the curve

*N* (Integer) is the maximum number of points on the curve

**EXAMPLE** *C=YHYPER(2.0,0.5,20,100)*

This statement sets C to the 20th Y-coordinate of a hyperbola consisting of 100 points

**NOTES** 1. No plotting takes place

**NAME** YHYPOT (Y-coordinate of an hypotrochoid)

**FUNCTION** Returns the Y-coordinate of a specific point on a hypotrochoid

**ARGUMENTS** (*RADFIX*, *RADMOV*, *DIST*, *I*, *N*)

*RADFIX* (Real inches) is the radius of the fixed circle

*RADMOV* (Real inches) is the radius of the moving circle

*DIST* (Real inches) is the distance of the traced point on the moving circle to its centre

*I* (Integer) is the number of the point on the curve

*N* (Integer) is the maximum number of points on the curve

**EXAMPLE** *C=YHYPOT(3.0,1.0,0.5,20,100)*

This statement sets C to the 20th Y-coordinate of a hypotrochoid consisting of 100 points

**NOTES**

1. No plotting takes place
2. The curve is clockwise

**NAME** YLISS (Y-coordinate of a lissajous curve)

**FUNCTION** Returns the Y-coordinate of a specific point on a lissajous curve

**ARGUMENTS** (*XSPAN, YSPAN, F, D, I, N*)

*XSPAN* (Real inches) is the width of the curve

*YSPAN* (Real inches) is the height of the curve

*F* (Real) is a factor affecting the number of loops in the 'X' direction

*D* (Real radians) is a displacement value

*I* (Integer) is the number of the point on the curve

*N* (Integer) is the maximum number of points on the curve

**EXAMPLE** *C=YLISS(2.0,2.0,1.0,0.0,20,100)*

This statement sets C to the 20th Y-coordinate of a lissajous curve consisting of 100 points

**NOTES**

1. No plotting takes place
2. The curve is clockwise

**NAME** YLSPIR (Y-coordinate of a logarithmic spiral)

**FUNCTION** Returns the Y-coordinate of a specific point on a logarithmic spiral

**ARGUMENTS** (*RADIUS, CYCLES, I, N*)

*RADIUS* (Real inches) is the final radius of the spiral

*CYCLES* (Real) is the number of cycles in the spiral

*I* (Integer) is the number of the point on the spiral

*N* (Integer) is the maximum number of points on the spiral

**EXAMPLE** *C=YLSPIR(3.0,2.0,20,100)*

This statement sets C to the 20th Y-coordinate of a spiral consisting of 100 points

**NOTES**

1. No plotting takes place
2. The curve is clockwise

**NAME**           YMIRRO (Y-coordinate of a mirror-image)

**FUNCTION**   Returns the Y-coordinate of a reflected point

**ARGUMENTS** *(X,Y,X1,Y1,X2,Y2)*

*X,Y*           (Real inches) are the coordinates of the point to be reflected

*X1,Y1*       (Real inches) are the coordinates of one point on the mirror

*X2,Y2*       (Real inches) are the coordinates of another point on the mirror

**EXAMPLE**    *C=YMIRRO(1.0,2.0,2.0,0.0,2.0,1.0)*

This statement sets C to the Y-coordinate of the reflected point 1.0,2.0.

**NOTES**       1. No plotting takes place

**NAME** YPARAB (Y-coordinate of a parabola)

**FUNCTION** Returns the Y-coordinate of specific point on a parabola

**ARGUMENTS** (*XSPAN, YSPAN, I, N*)

*XSPAN* (Real inches) is the width of the curve

*YSPAN* (Real inches) is the height of the curve

*I* (Integer) is the number of the point on the curve

*N* (Integer) is the maximum number of points on the curve

**EXAMPLE** *C=YPARAB(4.0,4.0,20,100)*

This statement sets C to the Y-coordinate of the *20th* point on a parabola consisting of *100* points

**NOTES** 1. No plotting takes place



NAME YPERSP (Y-perspective)

FUNCTION Transforms a 3-d point onto a 2-d picture plane

ARGUMENTS  $(X, Y, Z)$

$X, Y, Z$  (Real) are the coordinates of a point in 3-d space

EXAMPLE  $YW = YPERSP(1.0, 1.0, 1.0)$

This statement sets YW to the Y-coordinate of the point  $(1.0, 1.0, 1.0)$  on the picture plane

- NOTES
1. The position of the eye must be specified by a call on eye or fishi
  2. Ypersp is a real function

NAME YPOLY (Y-coordinate of a polygon)

FUNCTION Returns the Y-coordinate of a point on a polygon

ARGUMENTS (*RADIUS, I, N*)

*RADIUS* (Real inches) is the radius of the polygon

*I* (Integer) is the position on the polygon relative to *N*

*N* (Integer) is the number of points on the polygon

EXAMPLE *Y=YPOLY(2.0,6,8)*

This statement sets *Y* to the Y-coordinate of the 6th point on a polygon consisting of 8 points

NOTES

1. No plotting takes place
2. If there are *N* points on the polygon there are *N*-1 sides

**NAME** YROT (Y-coordinate rotated)

**FUNCTION** Returns the Y-coordinate of a point rotated theta degrees

**ARGUMENTS** (*X, Y, XP, YP, THETA*)

*X, Y* (Real inches) are the coordinates of the point to be rotated

*XP, YP* (Real inches) are the coordinates of the centre of rotation

*THETA* (Real degrees) is the angle of rotation  
-VE  $\equiv$  clockwise +VE  $\equiv$  anticlockwise

**EXAMPLE** *Y=YROT(1.0,1.0,0.0,0.0,45.0)*

This statement sets Y to the Y-coordinate of the point (1.0,1.0) rotated about the origin 45.0 degrees

**NOTES** 1. No plotting takes place

NAME YSIN (Y-coordinate of a sinewave)

FUNCTION Returns the Y-coordinate of a sinewave

ARGUMENTS (*AMP, WAVE, ANGST, ANGFIN, I, N*)

*AMP* (Real inches) is the amplitude of the sine-wave

*WAVE* (Real inches) is the length of the sinewave

*ANGST* (Real degrees) is the starting angle of the sinewave

*ANGFIN* (Real degrees) is the finishing angle of the sinewave

*I* (Integer) is the number of the point on the curve

*N* (Integer) is the number of points on the sinewave

EXAMPLE  $Y=YSIN(2.0, 4.0, 0.0, 360.0, 20, 100)$

This statement sets Y to the Y-coordinate of the 20th point on a sinewave containing 100 points

NOTES 1. No plotting takes place

NAME ZCOORD (Z-coordinate)

FUNCTION Returns the Z-coordinate of a specified vertex on a 3-d *Picasso* object

ARGUMENTS (*ARRAY,NL,NP*)

*ARRAY* (Real array) stores a 3-d *Picasso* object

*NL* (Integer) is the surface containing the point

*NP* (Integer) is the number of the point on the *nl*'th surface

EXAMPLE *Z=ZCOORD(S,1,1)*

This statement sets *Z* to the Z-coordinate of the *first* point on the object

---

1	DRAW	DIMENSION OF SHAPE ARRAY $\neq$ 2.0
2	DRAW	CONTOURS IN SHAPE ARRAY $<$ 1.0
3	DSHAPE	DIMENSION OF SHAPE ARRAY $\neq$ 2.0
4	ISOMET	DIMENSION OF CONTOUR ARRAY $\neq$ 2.0
5	MODSH	DIMENSION OF MODULATING SHAPE ARRAY $\neq$ 2.0
6	MODSH	DIMENSION OF SHAPE ARRAY $\neq$ 2.0
7	XCOORD	INVALID VERTEX NUMBER
8	YCOORD	INVALID VERTEX NUMBER
9	ZCOORD	INVALID VERTEX NUMBER
10	GROW2D	DIMENSION OF SHAPE ARRAY $\neq$ 2.0
11	GROW2D	CONTOURS IN SHAPE ARRAY $<$ 1.0
12	TURN3D	DIMENSION OF SHAPE ARRAY $\neq$ 3.0
13	ROTATE	DIMENSION OF SHAPE ARRAY $\neq$ 2.0
14	TRANSH	DIMENSION OF SHAPE ARRAYS UNEQUAL
15	TRANSH	DIMENSION OF SHAPES $\neq$ 2.0 OR 3.0
16	TRANSH	INVALID CONTOUR NUMBERS IN FIRST SHAPE
17	TRANSH	INVALID CONTOUR NUMBERS IN SECOND SHAPE
18	CLOK3D	DIMENSION OF SHAPE CONTOUR $\neq$ 3.0
19	REMOVE	INVALID CONTOUR NUMBER
20	NORMAL	DIMENSION OF SHAPE ARRAY $\neq$ 2.0
21	NORMAL	INVALID LINE NUMBER
22	NORMAL	INVALID POINT NUMBER
23	EXTEND	DIMENSION OF SHAPE ARRAYS UNEQUAL
24	EXTEND	INVALID CONTOUR NUMBER
25	SHIFT	DIMENSION OF SHAPE ARRAY $\neq$ 2.0
26	EXPLOD	DIMENSION OF SHAPE ARRAY $\neq$ 2.0
27	MIRROR	DIMENSION OF SHAPE ARRAY $\neq$ 2.0
28	MIRROR	CONTOURS IN SHAPE ARRAY $<$ 1.0
29	PULL	DIMENSION OF SHAPE ARRAY $\neq$ 2.0
30	PULL	CONTOURS IN SHAPE ARRAY $<$ 1.0

---

31	HULL	DIMENSION OF SHAPE ARRAY $\neq$ 2.0
32	HULL	CONTOURS IN SHAPE ARRAY $<$ 1.0
33	CYCLE	DIMENSION OF SHAPE ARRAY $\neq$ 2.0
34	CYCLE	CONTOURS IN SHAPE ARRAY $<$ 1.0
35	EXTSH	DIMENSION OF SHAPE ARRAY $\neq$ 2 OR 3
36	FILL	DIMENSION OF SHAPE ARRAY $\neq$ 2.0
37	FILL	CONTOURS IN SHAPE ARRAY $<$ 1.0
38	OBJECT	DIMENSION OF SHAPE ARRAY $\neq$ 3.0
39	OBJECT	CONTOURS IN SHAPE ARRAY $<$ 1.0
40	STICK	DIMENSION OF SHAPE ARRAY $\neq$ 2.0
41	STICK	DIMENSION OF 'STICK' SHAPE ARRAY $\neq$ 2.0
42	SMOOTH	PERIODIC SPLINE ERROR
43	ROW	DIMENSION OF SHAPE ARRAY $\neq$ 2.0
44	JOIN	DIMENSION OF SHAPE ARRAYS UNEQUAL
45	JOIN	DIMENSION OF SHAPES $\neq$ 2.0 OR 3.0
46	CONECT	DIMENSION OF SHAPE ARRAY $\neq$ 2.0
47	CONECT	CONTOURS IN SHAPE ARRAY $<$ 1.0
48	DRAW2D	DIMENSION OF SHAPE ARRAY $\neq$ 2.0
49	DRAW2D	CONTOURS IN SHAPE ARRAY $<$ 1.0
50	DRAW3D	DIMENSION OF SHAPE ARRAY $\neq$ 3.0
51	DRAW3D	CONTOURS IN SHAPE ARRAY $\neq$ 1.0
52	MPYSH	DIMENSION OF SHAPES UNEQUAL
53	MPYSH	INVALID CONTOUR FOR ARRAYA
54	MPYSH	INVALID CONTOUR FOR ARRAYB
55	SLOPE	DIMENSION OF SHAPE ARRAY $\neq$ 2.0
56	SLOPE	INVALID CONTOUR NUMBER
57	SLOPE	INVALID VERTEX NUMBER
58	MPYSH	INVALID OPERATOR NUMBER
59	MATOP	DIMENSION OF SHAPE ARRAY $\neq$ 2.0
60	SURFAC	DIMENSION OF SHAPE ARRAY $\neq$ 2.0

---

61	REVERS	DIMENSION OF SHAPE ARRAY $\neq$ 2.0
62	REVERS	INVALID CONTOUR NUMBER
63	MATOP2	CONTOURS IN SHAPE ARRAY $<$ 1.0
64		
65	INSIDE	DIMENSION OF SHAPE ARRAY $\neq$ 2.0
66	INSIDE	CONTOURS IN SHAPE ARRAY $<$ 1.0
67	TRACE	DIMENSION OF SHAPE ARRAY $\neq$ 2.0
68	TRACE	CONTOURS IN SHAPE ARRAY $<$ 1.0
69	SILUET	DIMENSION OF SHAPE ARRAY $\neq$ 2.0
70	SILUET	CONTOURS IN SHAPE ARRAY $<$ 1.0
71	SIZE	DIMENSION OF SHAPE ARRAY $\neq$ 2.0
72	SIZE	CONTOURS IN SHAPE ARRAY $<$ 1.0
73	SNOW	DIMENSION OF SHAPE ARRAY $\neq$ 2.0
74	SNOW	CONTOURS IN SHAPE ARRAY $<$ 1.0
75		
76		
77	FILL2D	DIMENSION OF SHAPE ARRAY $\neq$ 2.0
78	FILL2D	CONTOURS IN SHAPE ARRAY $<$ 1.0
79	CLOCK	DIMENSION OF SHAPE ARRAY $\neq$ 2.0
80	SMOOTH	DIMENSION OF SHADE ARRAY $\neq$ 2.0
81	SMOOTH	CONTOURS IN SHAPE $<$ 1.0
82	SMOOTH	CHORDAL DISTANCES NOT INCREASING
83	SMOOTH	CHORDAL DISTANCES NOT INCREASING
84	CLOSED	DIMENSION OF ARRAY $\neq$ 2.0
85	CLOSED	INVALID CONTOUR NUMBER
86	WINDOW	DIMENSION OF ARRAY $\neq$ 2.0
87	WINDOW	CONTOURS IN SHAPE ARRAY $<$ 1.0
88	SHIFT3	CONTOURS IN OBJECT ARRAY $<$ 1.0
89	SHIFT3	DIMENSION OF ARRAY $\neq$ 3.0
90		



91	TRANSP	DIMENSION OF ARRAY = 2.0
92	TRANSP	CONTOURS IN SHAPE ARRAY < 1.0
93	NYSUB	DIMENSION OF ARRAY ≠ 2 OR 3
94	NYSUB	CONTOUR ARGUMENT TOO LARGE
95	NXSUB	DIMENSION OF ARRAY ≠ 2 OR 3
96	NXSUB	CONTOUR ARGUMENT TOO LARGE
97	FIT	DIMENSION OF ARRAY ≠ 2
98	FIT	CONTOURS IN SHAPE < 1.0
99	NZSUB	DIMENSION OF ARRAY ≠ 2 OR 3
100	NZUB	CONTOUR ARGUMENT TOO LARGE
101	HATCH	DIMENSION OF SHAPE ARRAY ≠ 2.0
102	HATCH	CONTOURS IN SHAPE < 1.0
103	MASK	DIMENSION OF SHAPE ARRAY ≠ 2.0
104	MASK	CONTOURS IN SHAPE < 1.0
105	RIPPLE	DIMENSION OF ARRAY ≠ 2.0
106	RIPPLE	INVALID CONTOUR
107		
108		
109	THICK	DIMENSION OF SHAPE ARRAY ≠ 2.0
110	THICK	CONTOURS IN SHAPE ARRAY < 1.0
111	DOTUET	DIMENSION OF CONTOUR ARRAY ≠ 2.0
112	DOTUET	CONTOURS ON CONTOUR ARRAY < 1.0
113	PERSHP	DIMENSION OF SHAPE ARRAY ≠ 2.0
114	PERSHP	CONTOURS IN SHAPE < 1.0
115	MIX2D	DIMENSION OF SHAPE ARRAY ≠ 2.0
116	MIX2D	CONTOURS IN SHAPE < 1.0
117	MIX3D	DIMENSION OF OBJECT ARRAY ≠ 3.0
118	MIX3D	CONTOURS IN OBJECT ARRAY < 1.0
119	ROW3D	DIMENSION OF OBJECT ARRAY ≠ 3.0
120	ROW3D	CONTOURS IN OBJECT < 1.0
121	FILL3D	DIMENSION OF OBJECT ARRAY ≠ 3.0
122	FILL3D	CONTOURS IN OBJECT < 1.0