

Active Disassembly Applied to End of Life Vehicles

A thesis submitted for the degree of Doctor of Philosophy

By

Nicholas Jones
Department of Design
Brunel University, Runnymede

August 2003

For the attention of candidates who have completed Part A

- i) Attention is drawn to the fact that the copyright of a thesis rests with its author.
- ii) A copy of a candidate's thesis is supplied to the Library on condition that anyone who consults it is understood to recognise that its copyright rests with its author and that no quotation from the thesis and no information derived from it may be published without the prior written consent of the author or the University, as appropriate.

Requests for such permission should be addressed in the first instance to the Head of Library Services.

Abstract

Active Disassembly is technology that has been developed to allow assemblies to readily separate for recycling when they are exposed to certain triggering conditions. It is based around fasteners that use 'Smart' Materials, typically Shape Memory Alloys (SMA) or Shape Memory Polymers (SMP). This has led to research in the field to be known as Active Disassembly Using Smart Materials (ADSM).

Particularly within the context of the EU End of Life Vehicle (ELV) legislation, ADSM has the potential to enable the achievement of the recycling levels required. In this thesis, active disassembly solutions have been developed which have focused on the disassembly of the Instrument Panel, and the glazing within a vehicle. To achieve this, a number of novel Smart fastening devices have been developed, two of which are triggered by integral heating elements.

This investigation also led to the creation of a new releasable hook and loop fastening system, known as 'Shape Memory Hook and Loop Fasteners' (SM-HALF). SM-HALF is a repositionable fastening system that can be released remotely under a thermal stimulus.

Research into the residual energy content of ELV batteries has been a significant part of the investigation. It has been found that it is possible to use the energy from 'dead' car batteries to power at least 16 shape-memory alloy devices constructed from 25-micron diameter wire, at End of Life. No external energy input is required for disassembly

This research is timely as it provides a means of reclaiming 10% of a vehicle that would otherwise be lost to the shredder.

The technology can: increase the number of parts available for recycling and reuse, separate waste streams, decrease shredder residue otherwise destined for landfill and increase economic returns for either the vehicle dismantling yards or shredder operator.

For the nicest people I know. . .

Contents

	Page
Title	i
Abstract	ii
Dedication	iii
Contents	iv
List of Figures	xi
List of Tables	xiii
List of Acronyms	xiv
CHAPTER 1: INTRODUCTION	1
Preface	1
1.1 Research Background	3
1.2 Statement of Thesis	5
1.3 Objectives of Research	5
1.4 Contribution to Knowledge	6
1.5 Summary of Chapters	6
1.5.1 Summary of Chapter 2	6
1.5.2 Summary of Chapter 3	6
1.5.3 Summary of Chapter 4	7
1.5.4 Summary of Chapter 5	7
1.5.5 Summary of Chapter 6	8
CHAPTER 2: LITERATURE REVIEW	9
2.1 Introduction	9
2.1.1 Take Back Legislation	9
2.2 Existing Automotive Recycling Procedures	13
2.3 What is Active Disassembly and What are the Benefits?	16

2.5.8 SMP	38
2.5.9 Shape Memory Ceramics	39
2.5.10 Materials Summary	40
2.6 Methods For Triggering Active Disassembly	40
2.6.1 Introduction	40
2.6.2 Hot Air Gun	40
2.6.3 Fluid Immersion	41
2.6.4 Induction Heating	42
2.6.5 Microwave Heating	42
2.6.6 Infra Red Conveyor	43
2.6.7 Laser Heating	43
2.6.8 Summary of Triggering Methods	44
2.7 Design Principles and Methodologies	44
2.7.1 Introduction	44
2.7.2 Design for Assembly Principles	45
2.7.2.1 Boothroyd and Dewhurst Method	46
2.7.2.2 CSC Design for Assembly Method	46
2.7.2.3 Hitachi AEM	47
2.7.3 Design for Disassembly	50
2.7.3.1 The Selection of the Dowie DfD Methodology	50
2.7.3.2 DfD Methodology	53
2.7.3.3 Problems with a DfD Methodology	54
2.7.4 Design for Recycling	54
2.7.5 Design for Maintainability	57
2.7.6 Design for Modularity	57
2.7.7 Summary: The Application of Methodologies by the Designer	60
2.8 Existing Work on Active Disassembly	61
2.8.1 Brunel University	61
2.8.2 CRT Disassembly	61
2.8.3 Nokia	62
2.8.4 Sharp	64
2.8.5 University of Tokyo	64
2.9 Motivation For Active Disassembly	65
2.9.1 University of Windsor, Canada	65
2.9.2 Waste Energy Research Group (WERG) at Brighton University	66
2.10 Economic and Whole Life Cycle Aspects of ADSM	66

2.10.1 LCA Results	66
2.10.2 Economic Benefits	67
2.10.3 Better Than The Shredder?	68
2.11 The Proposed Expansion of ADSM Investigation	69
CHAPTER 3: USER PULL	71
3.1 Introduction	71
3.2 The Dismantling System	71
3.2.1 'Natural' End of Life Vehicles- (n)ELVs	73
3.2.2 'Premature' End of Life Vehicles- (p)ELVs	76
3.3 Shredders	77
3.4 Time to Implementation	78
3.5 ELVs- an End User Survey	78
3.6 ADSM Design Guidelines	82
3.7 Scope For Investigation	85
CHAPTER 4: HOW ADSM COULD BE USED TO AID ELV DIRECTIVE COMPLIANCE- CASE STUDIES OF ACTIVE FASTENING SOLUTIONS	87
4.0 Automotive Applications	87
4.1 Case Study 1. Glass Removal Solutions Introduction	87
4.1.1 Experimental Method	88
4.1.2 Results	89
4.1.3 Conclusions	90
4.2 Case Study 2. Active Disassembly in Safety Critical Applications	
Introduction	92
4.2.1 Experimental Method	93
4.2.2 Results	95
4.2.3 Conclusions	95
4.3 Case Study 3. Additional Technologies for ELV Applications- Shape Memory Hook and Loop Fasteners. Introduction	97
4.3.1 Experimental Method	97
4.3.2 Results	99
4.3.2.1 Results of SM-HALF Performance	102
4.3.3 Conclusions	103
4.3.3.1 Velcro Types	103
4.3.3.2 Adhesive Types	104

4.3.3.3 SM-HALF Observations	105
4.3.4 Further Work	106
4.3.5 Further Trends In Product Modularity	107
4.4 Case Study 4. The EcoCar. Introduction	108
4.5 Summary	113
CHAPTER 5: ELECTRICALLY TRIGGERED ACTIVE DISASSEMBLY WITH NO EXTERNAL ENERGY INPUT	115
5.1 Electrical Disassembly: An Investigation into Self-Powered Mobile Telephone Disassembly	115
5.2 Electrically Triggered Disassembly Using Residual Battery Charge	116
5.2.1 Method	116
5.2.2 Results	122
5.2.3 Conclusions	125
5.2.4 Further Work and Levels of Innovation	126
5.3 Automotive Applications	127
5.3.1 Experimental Method	127
5.3.2 Results	129
5.3.3 Conclusions	130
5.4 Further Electrical Development	132
5.4.1 Electrically Heated SMA Fasteners	132
5.4.2 Electrically Heated SMP Fasteners	135
5.4.2.1 Experimental Method	135
5.4.2.2 Results	139
5.4.2.3 Conclusions	140
5.4.2.4 Further Active Concepts	142
5.5 Comparing Manual Disassembly With Electrical Disassembly Of An Instrument Panel Using The <i>Dowie</i> DfD Methodology	143
5.5.1 Introduction	143
5.5.2 Methodology Applied to an Instrument Panel	143
5.5.3 Disassembly Improvements from the Application of Electrically Triggered ADSM	148
5.5.4 Conclusions Drawn from the Application of the Streamlined DfD Methodology	150
5.6 ELV Applications	151

CHAPTER 6: Summary of Work	152
6.1 Introduction	152
6.2 Automotive ADSM Placed Into the Context of Existing Work	152
6.2.1 Retrospective Comparison with the Work of <i>Gupta at al.</i>	152
6.2.2 Further Evolution of the Brunel University Toolkit	153
6.2.3 Product Retro-fitting and Advantages Over the <i>Suga Selective</i> Disassembly System	153
6.2.4 Compatibility with Product Embedded Strategies	154
6.2.5 The Complementary Recycling Infrastructure: WERG	154
6.2.6 The Complementary Recycling Infrastructure: Cryogenic Separation	155
6.3 Industry Reaction Applied to ADSM Applied to ELVs	155
6.3.1 The Industrial Reaction	155
6.3.2 Reaction from Centro Ricerche Fiat, Torino	155
6.3.3 Reaction from the Ford Motor Company, USA	156
6.3.4 Reaction from Charles Trant Ltd.	156
6.3.5 Reaction from the Unaffiliated Yard	157
6.4 Chapter Summary	157
CHAPTER 7: Conclusions	158
7.1 Introduction	158
7.2 Chapter Summaries	159
7.2.1 Synopsis of Chapter 3	159
7.2.2 Synopsis of Chapter 4	160
7.2.2.1 Active Glass Removal	160
7.2.2.2 Active Steering Wheel Removal	160
7.2.2.3 SM-HALF	161
7.2.2.4 The EcoCar Instrument Panel	161
7.2.3 Synopsis of Chapter 5	161
7.2.3.1 Energy Evaluation	161
7.2.3.2 Electrically Heated Fasteners	162
7.2.3.3 Design for Electrical Disassembly	162
7.3 Further Work-	163
7.3.1 Shape Memory Engineering Polymers	163
7.3.2 Releasable Adhesives	163
7.3.3 Direct Electrical Connections	164
7.3.4 The Blue Tooth Bolt	164
7.3.5 Electrically Triggered SM-HALF	164

REFERENCES	166
Appendix A- Performance of Field Affected 'Smart' Actuator Materials	179
Appendix B- PVAXX Technical Data	180
Appendix C- Form DVLA V680	181
PUBLICATIONS LIST	183

List of Figures

Figure 1.1 The Fate of Many Abandoned ELVs	1
Figure 1.2 Timeline of Directive Implementation	4
Figure 2.1 Summarising Timeline to Show Implementation of the EU ELV Directive	11
Figure 2.2 Interactive Page from the IDIS Vehicle Disassembly Information System	14
Figure 2.3 Ford Intake Manifold Made From Friction Welded Recycled Nylon	15
Figure 2.4 Recent Decline in Scrap Steel Prices	18
Figure 2.5 Shape Memory Polymer Snap Fit	32
Figure 2.6 MSM Pump Chamber	36
Figure 2.7 SMA Stent Used to Expand a Vein Around Blood Clots	38
Figure 2.8 Formal Evaluation Methods Used for Design Evaluation	45
Figure 2.9 Features Making Part Handling for Manual Assembly Difficult	48
Figure 2.10 Design to Aid Insertion	49
Figure 2.11 Provision of Self Locating Features to Aid Alignment During Assembly	49
Figure 2.12 Minimising Parts to Minimise Adjustment and Aid Reliability	50
Figure 2.13 Design for Modularity Life Cycle	59
Figure 2.14 Promotional Information Sheet Produced by Nokia	63
Figure 2.15 Recovered Gold Fractions From a Materials Separation Plant	69
Figure 3.1 Material Composition of a Typical 1990's Vehicle	76
Figure 3.2 Typical Polymer Composition of a 1998 Vehicle	81
Figure 4.1 Conventional Arrangement for Door Window Glass Retention	88
Figure 4.2 SMA Clips Grip the Rubber and Glass Through a Modified Steel Channel	88
Figure 4.3 An SMP Slip Replaces the Conventional Rubber Slip in a Door Glass Assembly	89
Figure 4.4 Steering Wheel Mounted on the Steering Column	93
Figure 4.5 Wheel/ Airbag Retention Components	94
Figure 4.6i. Illustrating the Hot Probe Engagement	95

Figure 4.6ii. More Detail of the Probe Collar Interface	95
Figure 4.7 SM-HALF. Flexible Silicon Mould From Which the Hooks Were Cast, and the Moulded SMP Hooks	97
Figure 4.8 Velcro Evaluation Test Rig, Placed in an Oven to Observe Separation Temperature	98
Figure 4.9 SMP Hooks in their 'Closed' Position- Temperature Below T_g	103
Figure 4.10 SMP Hooks in their 'Open' Position- Temperature Above T_g	103
Figure 4.11 GM AUTOonomy	107
Figure 4.12 The Splendid EcoCar	108
Figure 4.13 The 'Active IP' for the Splendid EcoCar	109
Figure 4.14 Model Showing a Section of the IP on the EcoCar	110
Figure 4.15 Close up of the IP Rail, and the Brass Stud That Protrudes Through The IP	111
Figure 4.16 Cut Away Illustration of the Clock Assembly Held Together with SMP Bezel Screws	112
Figure 4.17 Vented Clock Body Allows for Fast Internal Heating to Take the SMP Retention Screws Above T_g	112
Figure 5.1 Switchable Battery. Testing Rig	117
Figure 5.2 Solution 1 Ejection Mechanism Details	120
Figure 5.3 A Schematic for the Latch Solution	120
Figure 5.4 Solution 2 Ejection Mechanism Details	121
Figure 5.5 A Schematic for the Active Arm Solution	121
Figure 5.6 'Latch' Solution and 'Active Arms' Eject Their Battery When the Wire is Triggered	125
Figure 5.7 Electrically Heated SMA Clip	133
Figure 5.8 Electrically Heated and Unwound Circlip	135
Figure 5.9 Assembled Electrically Triggered SMP Snap-Fit	136
Figure 5.10 Heating Element Embedded in an SMP Snap-Fit	136
Figure 5.11 Flat SMP Clip With an Embedded Heating Element	137
Figure 5.12 Bent SMP Clip With an Embedded Heating Element	137
Figure 5.13 Large Flat SMP Clip With a Doubled Heating Element	138

List of Tables and Graphs

Table 2.1 Design for Disassembly Guidelines (Dowie 1995)	51-52
Table 3.1 Possible Areas for Implementation of ADSM Technology	86
Table 4.1 Thermal Testing of Commercial Velcro Samples	100
Table 4.2 Velcro Performance Summary	101
Table 4.3 Evaluation of Mechanically Clamped Velcro Samples	102
Graph 5.1 Battery Power When Discharged Through a 10.1R Resistor	122
Graph 5.2 Battery Power Over Time When Discharged Through a Muscle Wire	123
Graph 5.3 Repeatability- Power Against Time (5 sec Every 30)	124
Graph 5.4 Repeatability- Power Against Time (10 sec Every 30)	124
Table 5.1 Evaluation of the Energy Contained in 30 Randomly Selected ELV Batteries	130
Table 5.2 Tabulated Information on the Number of Shape Memory Wires that can be Triggered at EoL	131
Table 5.3 Performance Summary of Electrically Heated SMP Clips	139
Table 5.4 Disassembly Time for a Ford Fiesta MKIII Instrument Panel	144-148
Table 5.5 Revised Disassembly Time for an Active 'IP'	149

List of Acronyms

- ACORD- Automotive Consortium on Recycling and Disposal
ADSM- Active Disassembly Using Smart Materials
AEM- Assembly Evaluation Method
 A_f - Austenite Finishing Temperature
 A_s - Austenite Starting Temperature
B&D- Boothroyd and Dewhurst
CAD- Computer Aided Design
CARE- Consortium of Automotive Recycling
CFD- Computational Fluid Dynamics
CRT- Cathode Ray Tube
DFA- Design for Assembly
DfD- Design for Disassembly
DfE- Design for Environment
DFM- Design for Manufacture
DfMo- Design for Modularity
DfR- Design for Recycling
DfS- Design for Sustainability
DTC- Design to Target Cost
DVLA- Driver and Vehicle Licensing Agency
EEC- European economic Community
ELV- End of Life Vehicle
EoL- End of Life
EMR- European Metals Recycling
EMU- Engine Management Unit
EPSRC- Engineering and Physical Sciences Research Council
ER- Electro-Rheological
EU- European Union
FMCG- Fast Moving Consumer Goods

FMEA- Failure Modes and Effects Analysis
IDIS- International Dismantling Information System
IEEE- Institute of Electronic and Electrical Engineers
IEE- Institute of Electrical Engineers
IP- Instrument Panel
IR- Infrared
LCD- Liquid Crystal Display
M_f- Martensite Finishing Temperature
M_s- Martensite Starting Temperature
MOT- Ministry of Transport
MVDA- Motor Vehicle Dismantlers Association
MR- Magneto Rheological
MRF- Material Recovery Facility
MSM- Magnetic Shape Memory
PC- Polycarbonate
PDS- Product Design Specification
PLZT- Lead Lanthanum Zirconate Titanate
PP- Polypropylene
PU- Polyurethane
PVAXX- Company Producing Soluble Polymers
QFD- Quality Function Deployment
RoHS- Restriction of Hazardous Substances
SMA- Shape Memory Alloy
SMC- Shape Memory Ceramic
SME- Shape Memory Effect
SMP- Shape Memory Polymer
SORN- Statutory Off-Road Notification
SPC- Statistical Process Control
T_g- Glass Transition Temperature
T_m- Melting Temperature
TWSM- Two Way Shape Memory
T_x- Transformation Temperature
UV- Ultraviolet
VAT- Value Added Tax
WEEE- Waste Electrical and Electronic Equipment
WERG- Waste Energy Research Group

Chapter 1

Introduction

PREFACE:

The abandonment of End of Life Vehicles (ELV s) has increased by 400% in recent years¹. These vehicles pose an expensive problem for local authorities who have to deal with the clean up. Burnt out vehicles pose further economic, environmental and health and safety problems.



Figure 1.1 The Fate of Many Abandoned ELVs

- *Running a fire tender costs £250 per hour. With personnel and equipment costs added to this figure, the fire brigade estimate that each vehicle fire costs up to £10,000²*
- *Around 500- kilograms of material is consumed when a vehicle is burnt releasing Hydrogen Cyanide and producing Hydrofluoric acid. Temperatures reach 1100⁰C, so that even glass is melted²*
- *Fluorolastomec, a material used in brake seals and fuel pipes melts into a highly corrosive acid, which once on the skin, can not be removed. The only solution is amputation. 750 people were injured in this way last year²*
- *Fire brigade hosing causes toxins to be washed into the ground water. This can lead to suspension of local drinking water supplies²*
- *Once a vehicle is burnt, it becomes hazardous waste. Licensed contractors are then needed to remove the vehicle. Cost: £200³*
- *The scrap yard charges £35-50 for each vehicle⁴*
- *Hampshire County Council spent £300,000 on dealing with ELV's in 1997-98¹*
- *In 2002, Kent County Council spent £720,000 in Maidstone alone. The total cost incurred by all Kent's agencies was nearly £10 million- enough to fund the Kent Air Ambulance for 10 years²*

If vehicles could be dismantled more cost effectively, then dismantlers could pay more for an end of life vehicle and discourage dumping. This thesis considers design approaches for making dismantling more efficient.

1.1 RESEARCH BACKGROUND

Active Disassembly Using Smart Materials (ADSM) technology is in itself not especially new. Research has been underway in this area at Brunel University since the mid nineties (*Chiodo et al*^{5, 6, 7}). The main technology push has been the desire to create self recycling products, in order to ensure a greater volume of products are recycled than the current level, and in order to aid manufacturers to meet the targets laid down by the forthcoming Waste Electrical and Electronic Equipment (WEEE) legislation⁸.

The automotive industry also has to respond to similar recycling legislation in the form of the EU End of Life Vehicle (ELV) legislation⁹. Currently, the recycling system for ELVs and other metallic waste streams is the shredder, where material undergoes a mechanical size reduction process, and is then sorted into separate waste streams¹⁰.

In this investigation, various pre-shredder techniques for automotive disassembly have been explored. It is the aim of the investigation to see if it is possible to create systems of releasable retainers that can make a vehicle extremely fast to dismantle at End of Life (EoL), but which lie dormant during its operational life cycle or 'use phase'.

Active disassembly is not a competing technology to the shredding of EoL vehicles; it is a *complementary* technology. By allowing a dismantling technician to achieve greater pre-shredder part separation, recycling and re-use of components can be promoted. If more parts can be separated into waste streams *pre*-shredder, landfill from shredder residue can also be reduced. This in turn makes compliance with the ELV directive easier. Active disassembly is a time, energy and therefore money saving technology.

The ELV directive is an important driver for this work. Although the ELV directive is a significant piece of legislation, it should also be considered along with the other pending EU directives, which together represent the overall environmental strategy of the

European Community. This strategy, along with realistic filter thorough times , has been summarised by Visteon¹¹, a major tier 1 automotive manufacturer (figure 1.2).

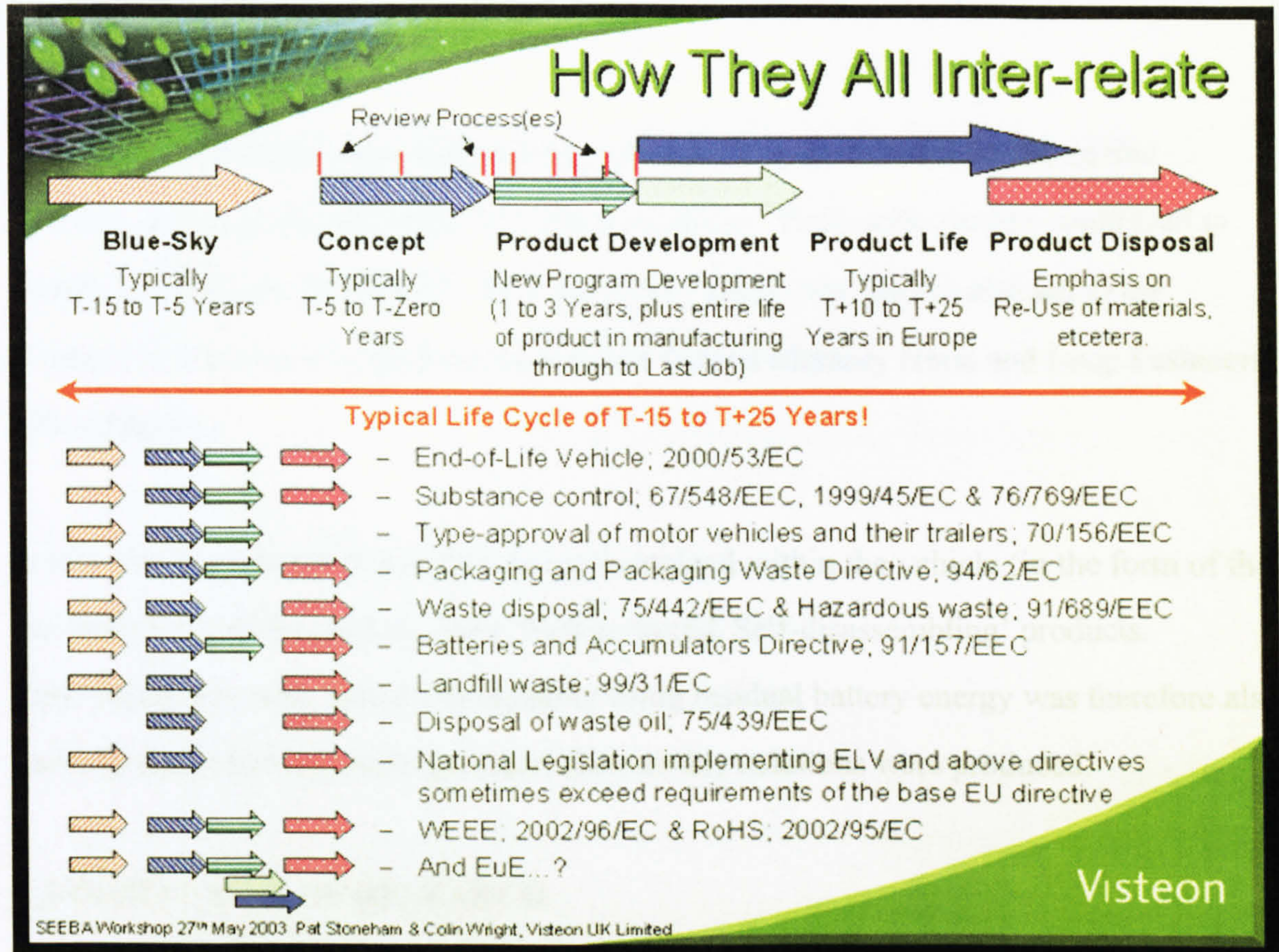

Figure 1.2 Directive and Life Cycle Timeline, Together With Times for Implementation, and Times for Effect (Figure Courtesy of Visteon¹¹ UK Ltd)

The preceding timeline spans some forty years. With the time taken for concepts to be generated (as in this three year study), the time taken for the work to be developed, and implemented into road-going vehicles (and therefore the product use phase)- design changes made now will still be significantly felt in the year 2040. It is important that the conclusions that have been reached within the scope of this study consider both the short term and long term implications. These implications must be considered both locally (dismantling technicians) and globally (global environmental impact, compliance with the Kyoto agreement and meeting the Bruntland Commission s definition of Sustainability).

1.4 STATEMENT OF THESIS:

Automotive Assemblies can be made to automatically disassemble when the EoL scenario occurs.

A number of different case studies were conducted to prove the feasibility of this concept, and to prove the integrity of the assemblies. These case studies could lead to simpler compliance with the EU ELV directive. These case studies also led to the creation of a new releasable fastener solution “Shape Memory Hook and Loop Fasteners” (SM-HALF).

It was also hypothesised that that energy contained within the vehicle (in the form of the car battery) could be used to create ‘Self-powered, Self-disassembling’ products.

Electrically powered Active Disassembly using residual battery energy was therefore also investigated, and electrically powered disassembly solutions were produced.

1.3 OBJECTIVES OF RESEARCH

The research programme had several objectives:

- To investigate the potential for transferring ADSM technology from the area of consumer electronic products, to the area of Automotive Disassembly
- To identify the possibility of using ADSM solutions in safety critical applications
- To expand the range of possible ADSM solutions, through investigating:
 - New materials for achieving active disassembly
 - New methods of triggering active disassembly
 - New design tools for the incorporation of ADSM at the initial design stage.

1.4 CONTRIBUTION TO KNOWLEDGE

This thesis shows that in principle, Active Disassembly systems could be used to aid automotive disassembly. Specific contributions include:

- Engineering development of electrically triggered Shape Memory Alloy fasteners for end of life vehicle disassembly
- Engineering development of electrically triggered Shape Memory Polymer fasteners for end of life vehicle disassembly
- Engineering development of Shape memory hook-and-loop fasteners for end of life vehicle disassembly.

1.5 SUMMARY OF CHAPTERS

1.5.1 Chapter 2 Summary

Chapter 2 is a literature review looking at current state of existing automotive recycling technology, active disassembly, 'Smart' materials and their applications, design methodologies, and existing state of the art work in the field.

1.5.2 Chapter 3 Summary

Chapter 3 investigates the most important areas for investigation from the perspective of potential users of the technology. In the context of disassembling ELVs, the most suitable areas to investigate are those that will allow compliance with the ELV directive to be most easily achieved, and those areas that currently have the greatest wastage. From discussion with various industrial practitioners [*Wilkins, D.*, EMR Ltd, and *Gaskin, I.*, Universal Vehicle Services/ Universal Salvage Plc], these areas were identified as being the glass contained with the vehicle, and also the large polymer parts contained within the vehicle.

1.5.3 Chapter 4 Summary

Chapter 4 details the disassembly case studies that were then undertaken. It became apparent in trying to remove an automotive dashboard or 'Instrument Panel' (IP) for its polymer content, that there was one large problem- the steering wheel was in the way. This was a problem for two reasons, firstly the steering wheel needed removing from its secure anchoring, and secondly because the steering wheel contains a dangerous explosive device in the form of the airbag. A novel fixing method was therefore developed to both aid safe airbag removal, and to ensure that the IP itself could become easier to remove.

Whilst completing the relevant case study investigations, another concept evolved. The concept of a something that would stick like glue, but would be repositionable. A material already existed in this category in the form of what is commonly known as 'Velcro'. A separate investigation was undertaken to see if it would be possible to create a 'shape- memory Velcro', a Velcro that could be stimulated to self-release.

1.5.4 Chapter 5 Summary

Chapter 5 deals with the refinement of the automotive ADSM concepts. Refinement was achieved in the form of two novel concepts, 'Electrically Triggered ADSM', and 'Active Disassembly Using No Significant External Energy Input'. Firstly, active disassembly solutions were developed that would trigger electrically. By making the ADSM components as electrical devices, they have the potential to be wired up and incorporated into a vehicle like any other electrical component. This eliminates the need for awkward heating arrangements, and the waste energy associated with spurious thermal conduction to unnecessarily heat additional parts. This was the first example of electrically triggered ADSM.

Further to this development, the ADSM concept evolved with the idea that self-disassembly should also be self-powered. A lot of energy can be expended in trying to

elevate the temperature of an assembly to trigger disassembly. Many products contain an energy source in the form of a battery, and a vehicle is no different. However, the battery contained in an automobile is one the most powerful types readily available. It would therefore seem logical to use some of this energy to power disassembly. An investigation was therefore conducted to evaluate the residual energy in ELV batteries and to assess its potential for powering vehicle disassembly. The first examples of 'self-powered, self-disassembling' assemblies were therefore created. The evaluation of the investigation into residual energy levels can also aid designers into designing successfully for self-powered self-disassembly.

1.5.5 Chapter 6 Summary

Chapter 6 Discusses the conclusions drawn from each of the preceding chapters, and how these conclusions can be used to further Eco-conscious vehicle design for the future.

Chapter six also discusses potential areas for further work both in the near and far future.

Short time-scale future work centres on the continuation of the work started in this investigation. Long time-scale future work looks at the potential for the integration of ADMSM vehicle technology with new emerging technologies from around the globe.

Chapter 2

Literature Review

2.1 INTRODUCTION

2.1.1 Take-Back Legislation

The EU has finalised its end of life vehicle disposal policy that guarantees no direct disposal cost for the user. Initially, the vehicle manufacturer will be footing the majority of the bill for the disposal of vehicles produced after January 1st 2006; and at the end of 2015, the manufacturer will be having to pay the majority of the cost for disposing of any of their vehicles-i.e. a retrospective legislation. It is estimated that this cost will be in the region of £80 per car by 2007¹². However, as the implementation of this legislation has been very difficult to instigate, the target dates for implementation have been pushed back. Under the latest version of the directive (2000/53/EC)¹³, the criteria and dates for enforcement are as follows:

"1. Member States shall take the necessary measures to encourage the reuse of components which are suitable for reuse, the recovery of components which cannot be reused and the giving of preference to recycling when environmentally viable, without prejudice to requirements regarding the safety of vehicles and environmental requirements such as air emissions and noise control.

2. Member States shall take the necessary measures to ensure that economic operators attain the following targets:

(a) no later than 1 January 2006, for all end-of-life vehicles, the reuse and recovery shall be increased to a minimum of 85 % by an average weight per vehicle and year. Within the same time limit the reuse and recycling shall be increased to a minimum of 80 % by an average weight per vehicle and year; for vehicles produced before 1 January 1980, Member States may lay down lower targets, but not lower than 75 % for reuse and recovery and not lower than 70 % for reuse and recycling. Member States making use of this subparagraph shall inform the Commission and the other Member States of the reasons therefore;

(b) No later than 1 January 2015, for all end-of-life vehicles, the reuse and recovery shall be increased to a minimum of 95 % by an average weight per vehicle and year. Within the same time limit, the re-use and recycling shall be increased to a minimum of 85 % by an average weight per vehicle and year.

By 31 December 2005 at the latest the European Parliament and the Council shall re-examine the targets referred to in paragraph (b) on the basis of a report of the Commission, accompanied by a proposal. In its report the Commission shall take into account the development of the material composition of vehicles and any other relevant environmental aspects related to vehicles. The Commission shall, in accordance with the procedure laid down in Article 11, establish the detailed rules necessary to control compliance of Member States with the targets set out in this paragraph. In doing so the Commission shall take into account all relevant factors, inter alia the availability of data and the issue of exports and imports of end-of-life vehicles. The Commission shall take this measure not later than 21 October 2002.

3. On the basis of a proposal from the Commission, the European Parliament and the Council shall establish targets for reuse and recovery and for reuse and recycling for the years beyond 2015.

4. In order to prepare an amendment to Directive 70/156/EEC (European Vehicle Type Approval), the Commission shall promote the preparation of European standards relating to the dismantlability, recoverability and recyclability of vehicles. Once

the standards are agreed, but in any case no later than by the end of 2001, the European Parliament and the Council, on the basis of a proposal from the Commission, shall amend Directive 70/156/EEC so that vehicles type-approved in accordance with that Directive and put on the market after three years after the amendment of the Directive 70/156/EEC are re-usable and/or recyclable to a minimum of 85 % by weight per vehicle and are re-usable and/or recoverable to a minimum of 95 % by weight per vehicle.

5. In proposing the amendment to Directive 70/156/EEC relating to the ability to be dismantled, recoverability and recyclability of vehicles, the Commission shall take into account as appropriate the need to ensure that the reuse of components does not give rise to safety or environmental hazards."

All of this information is relevant to the evolution of the 'as yet to be imposed' recycling infrastructure; and no one piece of information can be acted upon without first considering the environmental implications and practical implication impact. Essentially, the legislation is against- in theory- high-energy removal practices to recover low energy or low impact parts. The phasing in of the legislation can be summarised by *figure 2.1*.

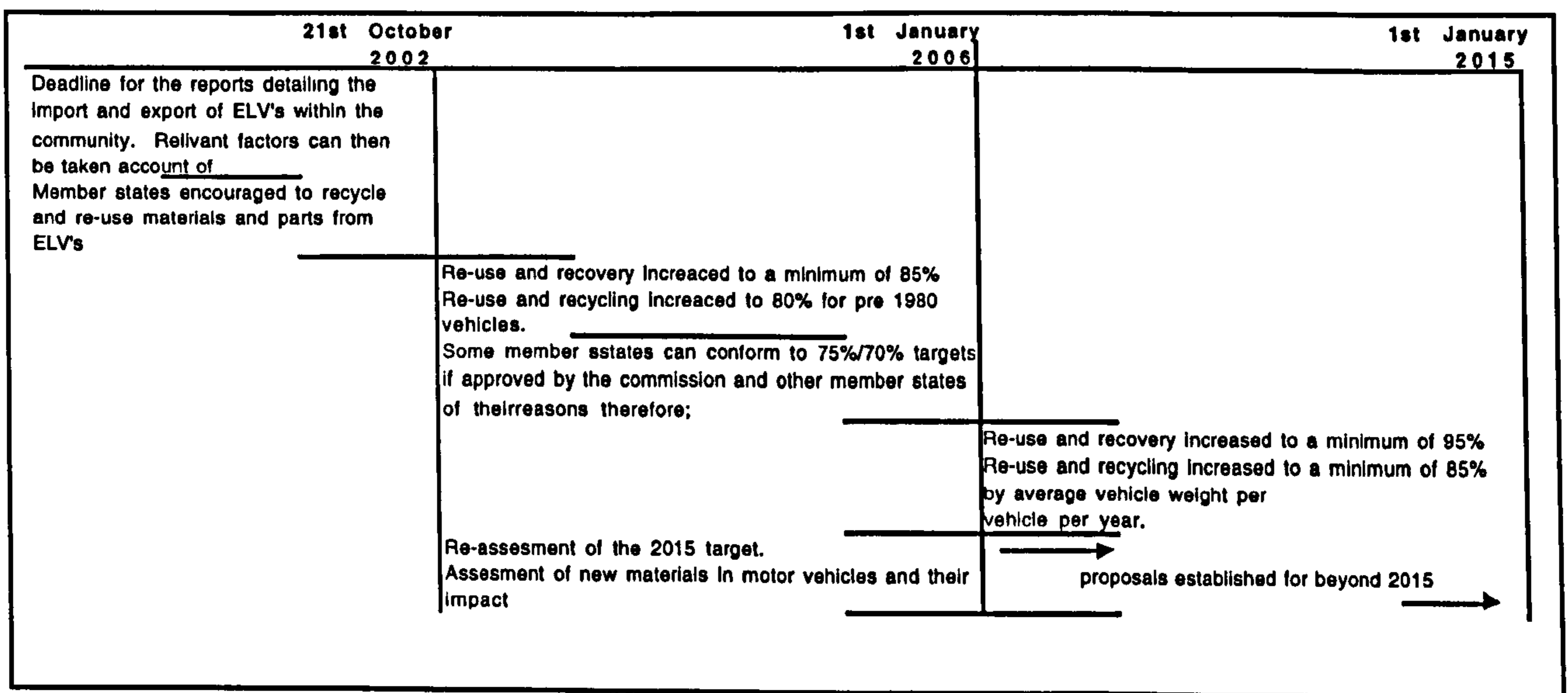

Figure 2.1 Summarising Timeline to Show the Implementation Schedule of The New EU ELV Directive. A global 'Directives Timeline' is also shown in figure 1.2

The legislation specifies lower re-use quantities for the older (pre-1980) vehicles, as well as specifying only re-use and recycling targets, not re-use and recovery. This is because there is no significant market for recovered (second-hand) vehicle parts that can be assumed for older non-cherished vehicles.

As part of the new EU legislation, approved vehicle dismantlers will have to conform to predetermined criteria⁹. Vehicle dismantlers such as G.W. & G. Bridges in Crawley are investing heavily to meet these standards, and are currently state of the art in terms of reprocessing plant and storage facilities. In accordance with guidelines, they have created the UK's first depollution station. Each of the two stations can theoretically process a car in eight minutes, by drilling into various pipes and tanks to remove all fluids.

However, due to the length of time taken to drain cold engine oil and transmission fluid, depollution actually takes around twenty minutes. Even shock absorber fluid can be recovered before the vehicle is shredded.

The MVDA (Motor Vehicle Dismantlers Association) is working hard to ensure its members meet the new criteria and become licensed in accordance with the EU guidelines. Certificates of destruction are then issued by the ELV processing station. This in combination with the vehicle road fund licence/SORN (Statutory Off-Road Notification) enforcement aims to achieve some level of vehicle traceability. Those EU member states without such an infrastructure, such as Spain, have to create such a system.

To aid vehicle disassembly, the EU is calling for common labelling of all materials with the adoption of a universal standard. The vehicle dismantlers also have to remove toxic materials such as zinc used in die cast door handles and lead used in wheel balancing weights. There was an appeal made to the commission for an exemption to be made to allow the continuation of lead to be used in wheel balancing weights but this was rejected. Also, initially, all heavy metals had to be reclaimed from the vehicle upon destruction.

Again this was overturned on grounds of practicality. Instead, there has been a prohibition on the use of heavy metals in all new vehicles¹⁴.

The only exclusions for the application of the ELV directive are for cherished vehicles. For all other vehicles, there are specific targets to be met in terms of recycling percentages by mass. For vehicles recovered after January 1st 2006, the minimum amount of re-use and *recovery* is 85% by average weight. The figure for re-use and **recycling** will be a minimum of 80%. For vehicles produced before January 1st 1980, the minimum figure is to be laid down by the member states, but it is not to be lower than 75%. By 1st January 2015, the re use and *recovery* limit will be raised to 95%, and **recycling** raised to 85% by weight⁹. Although these figures sound extremely significant, it must be noted that according to Roger Twiney, the chairman of ACORD (Automotive Consortium On Recycling and Disposal), the industry already recycles 75% by weight- higher than any other industrial sector.

ACORD is a collaboration between the major motor vehicle manufacturers, dedicated to improving the amount of ELV waste that is recycled. The target recycling percentages that ACORD set in 1998, are the same as the current EU target for ELV recycling.

2.2 EXISTING AUTOMOTIVE RECYCLING PROCEDURES

Twenty of the major Motor vehicle manufacturers are endorsing the IDIS (International Dismantling Information System) for vehicle part identification. In this system, a computer database has been compiled by various manufacturers, consisting of complete diagrams for all their cars, together with materials information and weights for all the parts. Participating dismantling sites have access to this information to aid them in vehicle disassembly. The information system also includes instructions on specific complete part removal systems-such as safe and successful airbag deployment¹⁵. The

IDIS interface is illustrated in *Figure 2.2*. Each part is a 'mouseover', which then displays all the relevant information on that particular part.

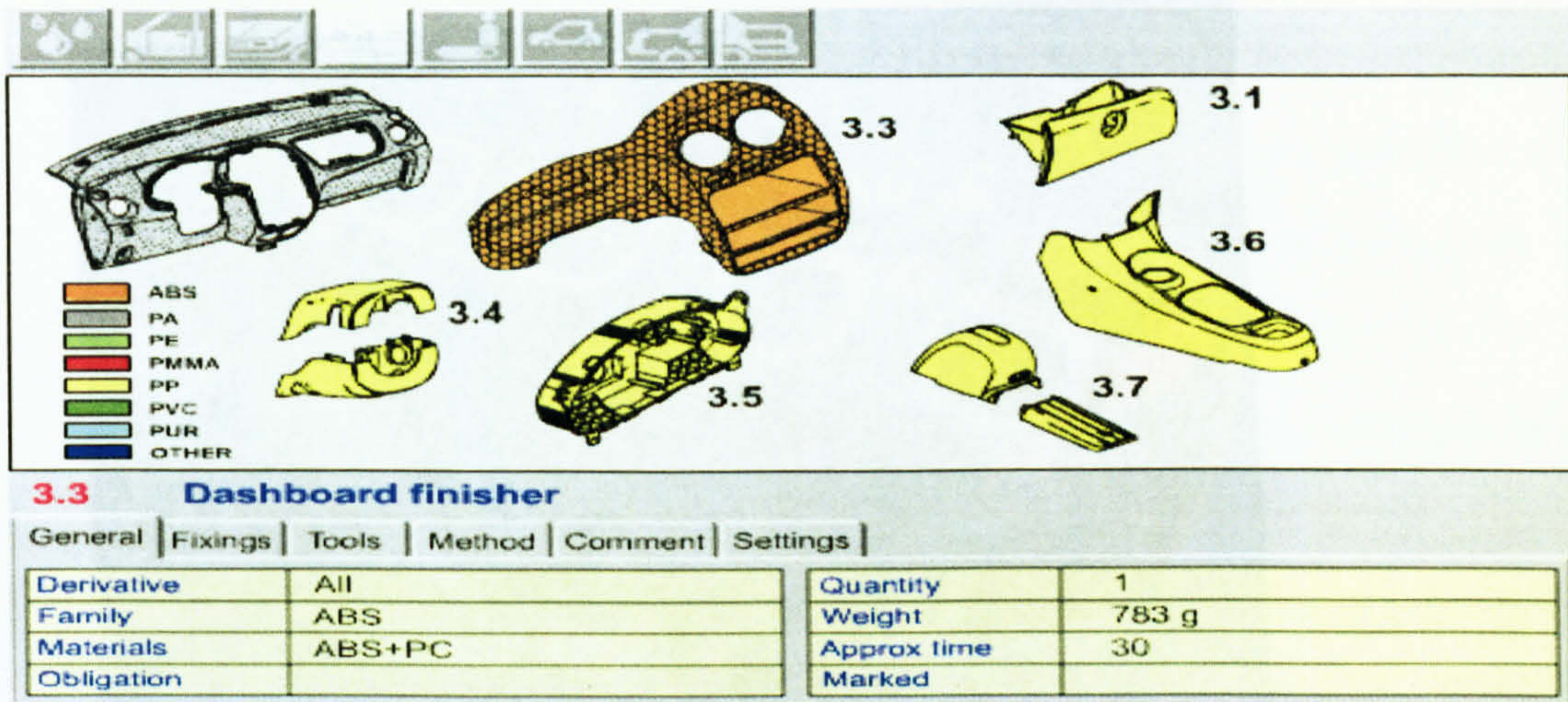

Figure 2.2 An Interactive Page From the IDIS Vehicle Disassembly Information System

CARE (Consortium of Automotive Recycling) is " *A collaborative project involving the main UK motor vehicle manufacturers/importers and vehicle dismantlers. Its objective is to research and technically prove materials re-use and recycling processes with a view to reducing the amount of scrapped vehicle waste going to landfill from the disposal of End of Life Vehicles.*" CARE is ensuring that its members are kept up to date with the EU ELV directive, and that their 29 independent member recycling sites, (or 'Depollution Stations') are also operating within the specified European targets¹⁶.

In accordance with the pending EU legislation with regards to vehicle recyclability, *Ford* and *Mercedes* are both claiming that their vehicles are up to 85% recyclable by mass. This will have both *Ford* and *Mercedes* on line for meeting the 2006 requirements if this standard is unified across their whole vehicle ranges. Recycled throwaway plastic parts are used extensively in their cars also. Telephone and computer casings are used as raw materials for instrument clusters, bottle caps are used in heater and air conditioning parts, and even Nylon carpets are used for intake manifolds and fan ducting (*as shown in figure*

2.3)¹⁷. There is also almost universal automotive industry reuse of old bumpers being reprocessed into new bumpers, and the reuse of old battery cases into new battery cases.

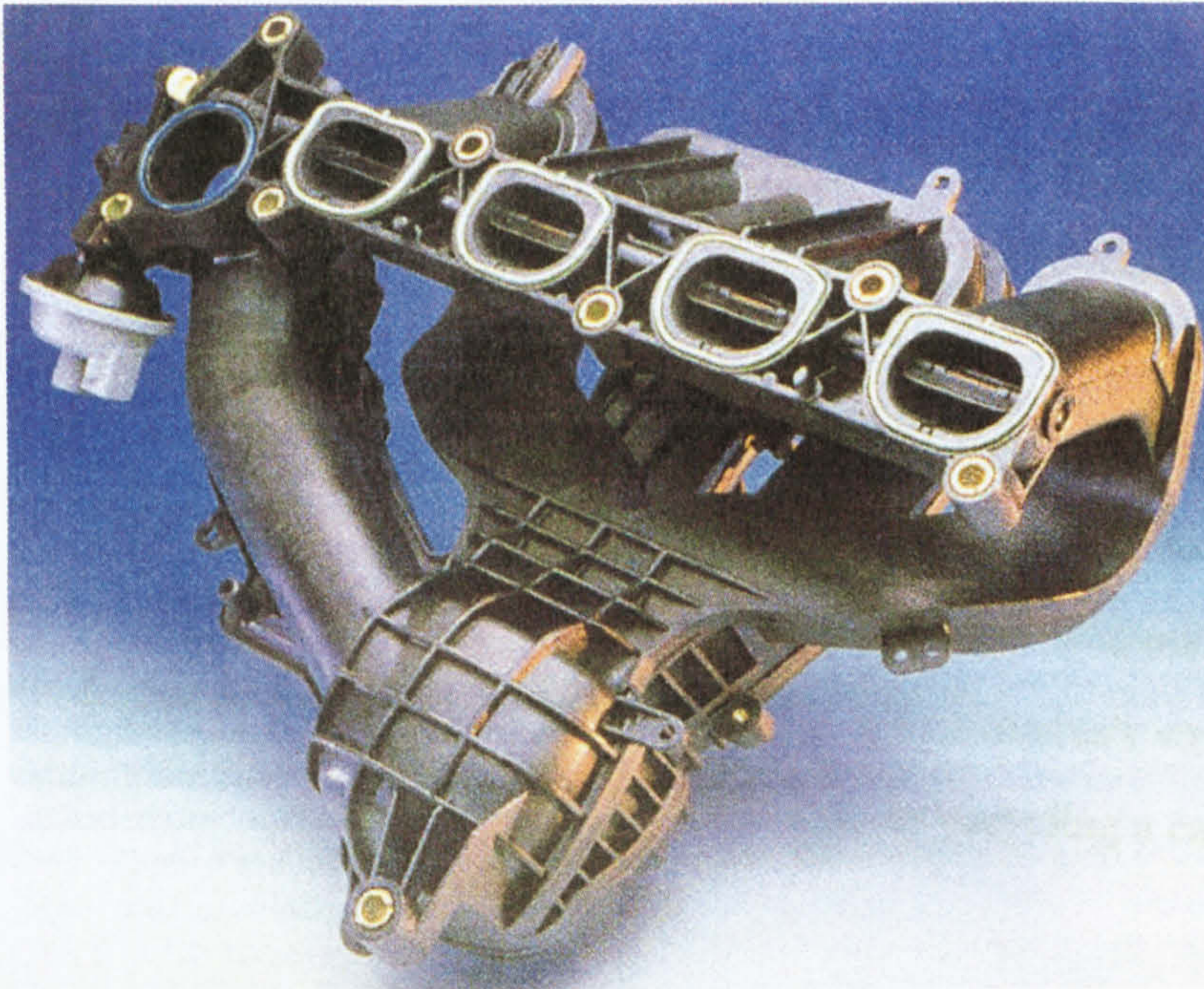

Figure 2.3 Ford Intake Manifold Made From Friction Welded recycled Nylon

Figure courtesy of the SAE, 'Automotive Engineering 2001

BMW have been implementing a take back scheme for some years. German law requires all manufacturers to arrange for their products to be taken back at the ends of their lives and recycled. In 1990 *BMW* first piloted a take-back scheme. They opened one of the first disassembly lines for scrapped cars in Landshut, Germany. By 1994 a comprehensive network of scrapped car recycling firms had been set up in consultation with other car manufacturers. When laws in other European countries require the same level of recycling as is current in Germany, these facilities will be extended. *BMW* would welcome standardised legislation establishing general conditions throughout Europe for the recycling of cars. In 1991 *BMW's* first partner to the nation-wide network of recyclers was formed, Preimesser in Munich. The recycling centre received disassembly manuals from *BMW* that were compiled at the Landshut plant and the staff were trained by *BMW*. High value parts are reconditioned and sold again as high quality spares (*re-use*). Plastic

parts are ground and re moulded after sorting at the disassembly stage (*recycling*).

Catalysts are separated and recycled to recover up to 90% of the platinum and rhodium used in their construction¹⁸.

With infrastructure such as this already put in place by the major vehicle manufacturers, the take-back legislation will not be nearly so difficult to implement as had originally been imagined. Even in America, *Ford* has been purchasing recycling plant across Florida. The manufacturers are beginning to see that not only is recycling and re-use environmentally sensible, but economically profitable. It must be noted however, that recycling plants are currently only planned where there is a high traffic density. Without doing a complete Life Cycle study, it is not too difficult to see that with America's vastness; transportation costs could quickly negate any energy savings made by recycling a car that is located in the outback.

2.3 WHAT IS ACTIVE DISASSEMBLY AND WHAT ARE THE BENEFITS?

2.3.1 Introduction

Life Cycle Analysis has highlighted the fact that the disposal phase of many products contributes significantly to the overall environmental impact of a product. This is particularly relevant to products that contain toxic, rare, or valuable materials- particularly those with a large embodied energy content⁷. By producing products that come apart readily or "Actively Disassemble", these high impact materials may be easily recovered for recycling or reuse.

Although the disposal phase of the automobile does not compare directly with the significance of the disposal phase of other industrial sectors (i.e. electronic equipment with a high content of precious metals), its embodied energy content is still very large.

Let us consider both the use phase along with the disposal phase:

As a very generalised calculation, if we consider a vehicle to weigh 1000Kg, embodying energy at $\approx 30 \text{ MJ Kg}^{-1}$, then we can say that the vehicle as a whole *embodies* an energy equivalent to 222 gallons of oil (taking: steel \approx coal $\approx 30 \text{ MJ Kg}^{-1}$). If we then consider that the vehicle has a life of 100,000 miles, which are covered at an average of 30mpg, then this vehicle *uses* an energy equivalent to ≈ 3333 gallons of oil. Although the use phase of the vehicle clearly consumes far more energy than the disposal phase, we must not forget that the ELV's impact is still potentially large due to its pollution potential, as illustrated in the introduction (*Chapter 1 p2*).

The implementation of the ELV directive makes recycling and reuse particularly relevant. The motor vehicle uses a great mass of many different types of metallic and non-metallic material, as well as containing quantities of electronic circuitry. As the motor vehicle manufacturers have to be responsible for the disposal of their vehicles produced after 2006⁹, active disassembly could provide a quick and reliable method of component or assembly separation, particularly for re-use. This notion of re-use is keenly endorsed by the insurance industry, who visualise a reliable, lower priced repair infrastructure coming on line as the vehicle dismantling industry adapts to the ELV legislation changes.

There is concern within the steel industry- of which the motor Industry is a major consumer- with regards to the build up of 'Tramp Elements' within the steel scrap stockpile. When vehicles are scrapped, there is often still a considerable amount of copper remaining in the vehicle from components such as the wiring loom, electric motors and radiators. As the copper in the scrap mix is reprocessed into fresh steel stock, the problem of 'Hot Shortness' arises. This occurs as the copper enriches the steel/scale interface by preferential oxidation of the Fe component. This then causes liquid embrittlement at the steel surface during hot working¹⁹. This will manifest itself as corrosion and fracture in the high stress areas of a pressing such as in a wheel arch. Due

to this copper build up in steel, the price of scrap has fallen. In 1994, a ton of scrap steel had a value on the metal market of around £75 per tonne. In 1999, the market value was no more than around £35 per ton according to the British Metals Federation (*see figure 2.4*)²⁰. For the man in the street, this translates to the local scrap-yard offering no more than around £7 per tonne for sorted scrap steel. The value of a scrap car is therefore practically zero. This has led to the undesirable social circumstance that the owners of ELVs are abandoning them rather than paying a vehicle reprocessing fee.

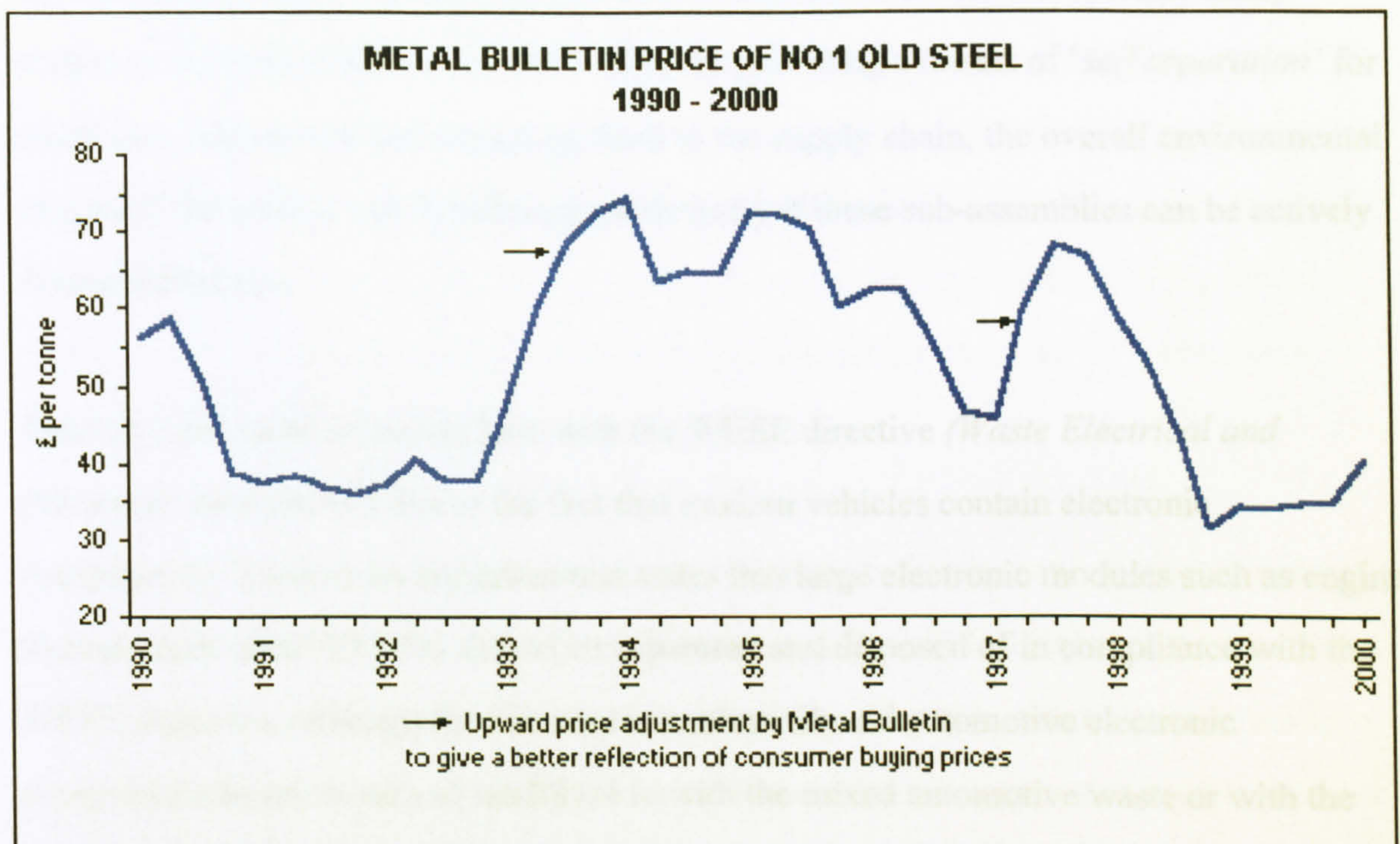

Figure 2.4 The Recent Decline in Scrap Steel Prices (Source: Brit. Met Fed.)

Plastics recycling is also of concern. Where metals are recovered quite successfully when the vehicle is shredded, the so-called 'light fractions' are comparatively neglected. Plastics use in motor vehicles has risen from 5% to 10% of a vehicles content by mass, (13 different types.) from 1970 to 1990²¹. It is important that this fraction is not repeatedly neglected. There is a closed loop for the recycling of metals already in existence. Plastics however need to have their loop closed by separation identification and reprocessing²².

By incorporating active disassembly into a motor vehicle, many of these problems can be overcome. An end of life infrastructure means all old vehicles have to be reclaimed and processed in accordance with EU guidelines. Typically this comprises the following steps:

- The vehicle is drained carefully of all its fluids to avoid potential fluid leaching
- Materials are significantly separated to allow efficient reprocessing with the minimum of waste.

By separating copper containing parts *with an automatic or 'Active'* system, tramp copper in the steel could be reduced. Also, by providing a means of *'self separation'* for electronic components and returning them to the supply chain, the overall environmental impact of the vehicle can be reduced; particularly if these sub-assemblies can be actively disassembled too.

There is a potential crossover here with the WEEE directive (*Waste Electrical and Electronic Equipment*⁸) due to the fact that modern vehicles contain electronic components. There is an argument that states that large electronic modules such as engine management units (EMU's) should be separated and disposed of in compliance with the WEEE directive, although the directive is unclear. Should automotive electronic components be removed and landfilled in with the mixed automotive waste or with the shredder residue? Manufacturers such as Visteon are interpreting the directive that all vehicle components should be treated in accordance with the ELV directive, all the time they remain in the vehicle. Once removed (such as the replacement stereo market), the waste must be treated in accordance with the WEEE directive. They therefore view that the design and recycling considerations for electronic sub-assemblies should lie with the sub-assembly manufacturer, and *not* with the designers of the instrument panel. The interpretation is that the directives should be treated 'vertically' within each relevant industry, and not 'horizontally' where crossovers will occur¹¹.

2.3.2 Active Electronic Disassembly Using Smart Materials

Current research at *Brunel University* is being based around SMA and SMP devices being formed into appropriate actuator shapes that are incorporated into host consumer electronic products to aid disassembly^{5,6,7}. When heated, the actuator can either apply a significant force to the case of a product, causing it to disassemble (SMA), or lose its mechanical integrity causing the product case to open (SMP). This research at the University has previously been funded by the EPSRC²³, and is currently being funded by the EU under their Framework Five programme. The conclusions of this project will be published towards the end of 2003.

2.3.3 Advantages of ADSM Over Manual and Robotic Disassembly

Prior to the work commencing on active disassembly, the state of the art for product disassembly centred around optimised manual disassembly systems^{96,97}, or robotic disassembly systems⁹⁸.

Although extensive algorithms for disassembly scenarios for the manual disassembly of recovered products have been developed⁹⁶, the system is still labour intensive, and lacks the ability to deal with significant product variations. These disassembly ventures have so far been based around electronic products, where disassembly is selective to maximise revenue⁹⁶. Whilst this may be suitable for electronic products, this technique would not meet the percentage mass requirements for the ELV's. Also, 'disassembly lines', such as those used by IBM⁹⁶ and BMW¹⁸ lack the flexibility to deal with wide product/manufacturer variants. The complexity of planning for disassembly as well as the time required increases with the number of components in a product, and the number of vehicle variants⁹⁷. This is again proven when trying to establish an automated or robotic disassembly line. Disassembly work cells can work systematically through known alternatives and expected module variations. It is also possible for a robotic system to work through a number of different 'jamming' situations⁹⁸. However, due to the large

number of vehicle variants, programming for generic vehicle disassembly would become almost impossible- coupled with the infinite number of dimensional changes to a vehicle that can be caused by repair or accident damage. By creating an 'internal' disassembly system to enable 'self-disassembly', interaction with disassembly lines or robotic disassembly systems could be significantly reduced or eliminated.

2.4 WHAT ARE SMART MATERIALS?

2.4.1 Introduction

There has been a lot of attention from the media in recent years with regards to 'Smart Materials'. These materials have been enormously diverse- from conductive fabrics to colour changing inks, and from nano-technology to shape-memory materials. Some of these genres of material have even been described as intelligent. Smart Materials can be described as materials that are engineered to react in a predetermined fashion under a specific stimulus. For disassembly purposes, the reaction required only involves a change between *two* states, and not an incremental or gradual reaction⁷. This is therefore a fairly simple stimulus response, but as of yet, there are no materials that 'think for themselves'. By the dictionary definition- we have yet to simply see any material 'show good intellect', or have 'mental power or ability'. For example, all of the electrically and magnetically responsive materials covered here respond in exactly the same way that motors and dynamos behave in relation to Electromagnetic fields and movement. Perhaps a more appropriate name for these classifications of materials would be '*responsive materials*', but for the time being we must continue with the existing terminology.

2.4.2 Thermochromic and Photochromic Inks

Thermochromic and photochromic inks have been used recently in a wide variety of mainly novelty products, from communication devices to t-shirts. In summary the inks change colour in response in response to light or heat and display a surface colour change.

The method of stimulation can be ambient conditions or body heat, through to electrically heated or fibre-optic light source activated devices. The inks show no drastic rheological changes although there are fluids that can exhibit this behaviour. These fluids are detailed in the next section.

2.4.3 Electrorheological and Magnetorheological Fluids

Electro-rheological (ER) and magneto-rheological (MR) fluids can dramatically increase their viscosity in the presence of an electric current or a magnetic field. Recently these fluids have been used to great effect in the field of automotive dampers for active suspension systems. They consist of dielectric particles 0.1-100 microns in diameter, suspended in a dielectric fluid. Since the dielectric constant of the suspended particles is larger than the dielectric constant of the base fluid, an external electric field polarises particles. Polarised particles interact and form chain-like or even lattice-like organised structures. Simultaneously, the rheological properties of the suspension change. ER-suspensions also have a magnetic analogue. These consist of ferromagnetic particles and a base liquid. As the viscosity of the electrorheological liquid can be controlled with the electric field strength, the viscosity of magnetorheological fluid is sensitive to the magnetic field.

These fluids react very rapidly to the applied field. The response time of electrorheological fluids is of the order of 1-10 ms. Perhaps the most striking application utilising electrorheological fluids is an artificial muscle made of polymer suspended particles in a polymer gel²⁴.

So far most of the suggested applications of the ER/MR-fluids operate in shear mode, i.e. direction of loading is perpendicular to the electric/magnetic field. However, instead of shearing, these fluids can also be stressed parallel to electric/magnetic field²⁴.

2.4.4 Magnetostrictive Principles

Magnetostriction has been described as ‘Movement with magnetics’. Magnetostriction is a property encountered in magnetic materials when the sample changes shape upon the introduction of a magnetic field. This property can be usefully engineered into actuator applications.

The most widely used magnetostrictive material is a rare earth alloy known by the name of Terfenol-D, which became available in commercial quantities in 1987. In a minimal magnetic field, it can generate strains in the region of over 0.1%- around 10 times more than any other magnetostrictive material. Such movement can also be generated under load, with a magnetic to mechanical energy efficiency of over 60 percent. It also operates at these levels at room temperature. No cooling is required, unlike most other materials of this type. Conversely, as with most other materials of this type, the magnetic effect is reversible, and when a sample is strained, mechanical energy is converted to electrical energy²⁵.

2.4.5 Magnetic Shape Memory Materials

Ferromagnetic shape memory alloys.

Magnetically controlled Shape Memory alloys (MSM) such as Ni-Mn-Ga, show field-induced strains at room temperature greater than those of any Magnetostrictive, Piezoelectric or Electrostrictive material. This is a new class of ‘smart’ material, which, like piezoelectric and magnetostrictive (e.g. Terfenol-D) actuator materials, can produce force and motion by applying a low (0.5 T) magnetic field. However, the big advantage of MSM is that it can develop strains of up to 6 %. Other field-affected materials such as magnetostrictive Terfenol-D can only produce strains of up to 0.12%. Conversely, mechanical loading of the MSM material changes the surrounding magnetic field and opens up the potential for use of the material in a sensor application. Material properties are detailed in Appendix A²⁶.

MSM materials are currently in production by companies such as AdaptaMat in Finland. Their actuator devices are currently producing forces up to 1.5 kN and strokes of up to 5 mm. These values can be increased using appropriate actuator design or amplifying devices. AdaptaMat currently produce "room temperature" materials, i.e. materials operating up to 32 °C, and "high temperature" grades with operating temperature up to 70 °C. Unless these materials are suitably shielded, their useful temperature range falls outside the required specification for most automotive applications. The company does however have a material under development to operate in the temperature range of 120-150°C. The material properties dictate that the material is somewhat brittle and does not take well to shock loads. Also, due to the expensive elements used in the production of these materials, the cost of these materials is very high- being an order of magnitude more expensive than more common 'thermal' Shape Memory Alloys²⁶.

2.4.6 Soluble Materials

Soluble polymers are simply plastics that can dissolve under certain conditions.

Although most polymers degrade over time, light is usually a key factor in this occurrence and it takes many years. Also, most polymers are susceptible to solvent degradation, usually using harsh chemicals. These would not be acceptable methods for achieving disassembly either due to the excessive time required, or due to the hazardous and environmentally damaging chemicals needed. However, modified polymers based upon the base resin Polyvinyl Alcohol (PVOH) patented by PVAXX R&D Ltd have the ability to dissolve and fragment when immersed in water at 20°C. The process can be accelerated 5-10 times by increasing the solution temperature to 60°C. Most applications so far have been with regards to medical usage. However, patent no. WO0164421²⁷ is an example for pressed pill capsules; the technical specification of the material reveals the potential for using the injection moulding grade of the material for more structural applications. The technical specification is listed in Appendix B.

There are other 'soluble' polymers available such as those from BioProgress- used to make pill capsules, but these don't offer the structural, injection-moulding potential of the PVOH polymers. Similarly, the Warwick Manufacturing Group at Warwick University have been looking at developing compostable composites that are starch based²⁸. Again, for vehicle disassembly, the time taken for degradation is far too slow.

2.4.7 Shape Memory Alloys and Polymers

The most commonly found Smart materials generally fall into two classifications, 'Shape Memory Alloys' ('SMA'), or 'Shape Memory Polymers' ('SMP'). These materials change their mechanical properties in relation to temperature, or more specifically a 'transformation temperature', ' T_x ', and have been used in a variety of active disassembly products⁷. When T_x is reached, the 'Shape Memory Effect' ('SME') occurs and the material will physically deform, or recover a previous shape. These materials are not bimetallic alloys. The shape change is caused by the change in crystalline structure from Martensite to Austenite and vice-versa

2.4.7.1 The Shape Memory Effect of SMA

The underlying shape memory effect is a martensitic transformation that creates a polydomain phase upon cooling. This polydomain phase accommodates finite reversible mechanical deformations through domain wall motion, generation and/ or annihilation without significant changes in the mechanical self-energy of the system. Hence, upon retransformation to the austenitic state, the system returns to its former macroscopic state displaying the well known mechanical memory²⁹.

Due to the differing types of SMA material available, different material behaviours can be observed when the shape memory effect occurs. With this in mind, SMA materials can fall broadly into three different classifications, one-way, two-way and multi-way.

2.4.7.2 One-Way SMA

One-way SMA's are materials that can recover to their original form once. They *can* be cycled again, after they have been 'reformed' into their 'starting position'. A common example of a one-way SMA is Nickel Titanium (NiTi). Due to the alloying elements forming the material, NiTi is expensive compared to common engineering metals. Due to its hardness it is also difficult to form NiTi based alloys. The T_x for NiTi devices ranges from around -150°C up to $+120^{\circ}\text{C}$, depending upon the ratio of Ni to Ti. The ratio of Ni to Ti for shape memory alloys ranges from 49% to 51%³⁰.

2.4.7.3 Two-Way SMA

Two-way SME materials are materials that can recover their original form *after* they have deformed and undergone their SME. The amount of successful times the material can recover and reform depends on the material, extent of deformation (i.e. percentage strain) and the extent of stimuli (i.e. the sample is not over heated or tempered)³¹. If the sample is strained to around 5%, the devices can be expected to cycle reliably for millions of cycles. Two-way devices are usually a Cu-Zn material, or a Cu-Zn-Al material. The T_x for these materials does not span such a wide temperature range as for the Ni-Ti devices (around -80°C up to $+80^{\circ}\text{C}$), and due to the nature of the alloying materials, devices formed from Cu based alloys are neither as strong or as hard as their Ni based counterparts. Cu based alloys are more ductile, and they are cheaper than Ni-Ti materials.

2.4.7.4 Multi-Way SMA

Multi-Way SME materials resemble two way materials in every way, except that they change shape incrementally with regards to temperature, i.e. for every degree of temperature rise there will be a unit of deflection⁷. Where most SMAs achieve all their deflection once the triggering temperature is reached, a multi-way device will merely begin its transition at the triggering temperature. Like the two-way SME, Multi-Way devices will recover the majority of their shape upon cooling and will cycle virtually indefinitely.

The properties of these materials can be practically applied in the form of temperature controlled air-conditioning vent louvers and other thermally controlled systems. These materials are again usually Cu-Zn materials, precisely alloyed for a desired effect.

Harrison does identify that practically all of a SMA's properties will change during transformation. These include: Feel, acoustic emission, ring, electrical resistance, bend, magnetic properties, colour, EMF, roughness, thermoelectric power, hardness, hall coefficient, expansion, heat capacity, yield, Young's modulus, thermal conductivity, damping, lattice spacing, internal friction, electron density waves and velocity of sound; and that there is a hysteresis associated with all these property changes. From this list of property changes though, it is simply the shape change, and force associated with it, that is of interest for this investigation³².

2.4.8 The Shape Memory Effect of Shape Memory Polymers

Shape Memory Polymers (SMP) are different to SMA in that when the shape memory effect takes place, a SMP sample loses all its mechanical strength. Conversely, a SMA sample can apply a force, or relax a previously strong grip.

All polymers have some degree of shape memory characteristic, but the transition from a glassy composition to rubbery state is very gradual upon heating. A SMP sample however undergoes this transition very suddenly. The point at which this transition occurs is called the 'Glass Transition Temperature' (T_g). The cycle for a SMP is similar to that of one way SMA, except that the force required to mechanically deform the samples is so low that it is almost negligible. The self-weight of a flat sample of heated polymer is usually sufficient to cause a flat shape to collapse. The stiffness of a part can of course be increased by changes in geometrical section. Also, being that the transition temperatures are so low ($\approx 60^\circ$), again the energy expenditure required to train a sample is lower when compared to shape memory alloys.

At room temperature, chemical crosslinking and microcrystalline structures coexist within thermoplastic polymers. Upon heating the polymer above T_g , the microcrystalline parts melt and the polymer can be deformed under stress. At this temperature, chemical crosslinking points still remain and store energy upon deformation. The deformed state is fixed by cooling below T_g . When heated above T_g , the strain energy stored within the polymer returns it to the original shape³³.

The specific SMP used for ADSM applications is a polyurethane block copolymer with optimised shape memory characteristics. Segmented polyurethane is an important class of multi-block copolymer, consisting of alternating sequences of hard and soft segments, which exhibit shape memorising properties. The characteristics of shape recovery and shape fixivity exist owing to the difference in kinetic properties of molecular chains at temperatures below and above T_g . It has been suggested that this shape memorising property of SMP may be ascribed to the molecular motion of the amorphous soft segments⁵.

2.4.9 Training Shape Memory Alloys and Shape Memory Polymers

To achieve a useful shape change when the SME occurs, shape memory samples must be trained³⁴.

2.4.9.1 Training a One-way SMA:

Most commercially available NiTi is 'superelastic' in typical ambient temperatures. The material has been significantly hardened by manufacturing processed and is in its 100% martensite state; therefore annealing is necessary to remove superelasticity. Superelastic samples are almost impossible to cut with conventional cutting tools, and are extremely difficult to kink. Bent samples show exceptional springiness. It is in this 100% martensite form that eyeglass frames are sometimes constructed, as they become very difficult to break. Annealing temperatures for NiTi are in the range of 700-800 degrees

Celsius. 'Training' is then conducted by placing the designed SMA device within a fixture in a form required for the memorised shape. The jig and the sample contained within it are then heated to the training temperature range of 400-600 degrees Celsius for 45 minutes. The SMA is then immediately immersed in cool water. This induces and locks the Martensite crystalline structure within the material. This is then in effect the shape that the material *wants* to be. The SMA device can then be deformed, and when actuated it will recover the 'trained' shape that was instilled in the sample whilst in the jig. The sample can then be mechanically re-formed after actuation.

2.4.9.2 Training a Two-way SMA:

Two Way Shape Memory (TWSM) is a 'learned' behaviour for a shape memory alloy and it can be achieved in several ways. Under normal circumstances, the SMA piece will remember its high temperature state, but upon heating to *recover* its high temperature shape, it will forget its low temperature state. TWSM can be achieved in several ways, providing a suitable material is chosen³⁵.

2.4.9.2.1 Training By Overdeformation While in the Martensitic Condition:

The alloy is cooled below its Martensite finishing temperature (M_f) and whilst in the martensitic state it is bent to well beyond the usual recoverable strain limit (app. 10%). When reheated to the parent phase range, the alloy will not completely recover due to excessive deformation of the Martensite. However, when cooled again into the martensite range, the alloy will spontaneously move back towards the overdeformed shape. The material piece can then be cycled between these two states³⁵.

2.4.9.2.2 Training by Shape Memory Cycling:

The procedure consists simply of repeating the shape memory training cycles until two-way behaviour starts to be demonstrated. One training cycle would consist of the

component being cooled to below M_f , deformed to a level below the SM strain limit, then heated to recover the original high temperature shape. The process starts to take place spontaneously after five to ten training cycles, and spontaneous shape change will occur on cooling. The amount of shape change will be less than for overdeformation training, with the spontaneous shape change being in the order of 20-25% of the training strain. The strain induced in training will typically be around 6%, so the recovered spontaneous TWSM strain is likely to be no more than 1-2%³⁵.

2.4.9.2.3 Training by Pseudoelastic Cycling:

This method consists of repeatedly stress inducing Martensite by loading and unloading the parent phase above the Austenite finishing (A_f) temperature, but below where superelastic behaviour is expected. 5-10 training cycles are required and the recovered strain upon heating and cooling is a fraction of the training deformation. This method is simple but difficult to train accurately³⁵.

2.4.9.2.4 TWSM Summary

Combinations of these methods can also be used to achieve the TWSM effect. With every method though, the following points must be noted:

- The strains available in TWSM are relatively small
- Forces able to be exerted will be of the usual order upon heating, but relatively weak on cooling
- There is a tendency for TWSM behaviour to decay with continual cycling, particularly against a biasing spring

2.4.9.3 Training SMP:

The training of an SMP sample is very quick when compared to SMA, as no annealing or thermal soaking is required. Also, the temperature threshold required for training is the same as for actuation. The initial sample shape is determined by how the SMP piece is

initially cast. Currently, SMP material can only be manufactured and supplied by Mitsubishi Heavy Industries due to their level of patent protection. It is supplied as a two-part resin for casting, granules for injection moulding or as flat sheet. It is a Polyurethane (PU) based material.

A typical training cycle for a SMP comprises the following steps:

- The untrained sheet sample is heated to 60°, possibly with hot water.
- The sample undergoes a drastic drop in modulus and is able to be moulded around a former
- The polymer air cools, or can be rapidly quenched with cool water. The polymer will retain the formed shape indefinitely if the strain values are low (>100% out of a possible 400%- so that creep does not occur)
- When reheated, the polymer will try to resume its initial flat sheet shape providing that no external forces apply. It must be noted that as the SME occurs, the force exerted is so low, that gravity acting on a thin sheet may be enough to prevent complete shape recovery. The maximum recovery force can be in the region of 1 MPa, depending on the shape section³⁶.

An example of how a SMP piece may be more usefully used in a situation where more structural integrity may be needed:

- The initial SMP sample is cast into a dowel shape instead of a flat sheet.
- The dowel is then machined on a conventional lathe to make something like a snap-fit barrel. (The sample must be carefully cooled to be successfully machined)
- The snap-fit is assembled using a spring that loads the joint.
- When the joint is heated, the snap-fit loses its integrity, and with the aid of the spring disassembles (*see fig 2.5.*)
- As the joint is now unloaded and above T_g , the snap-fit resumes its original shape and once cool, can be snap-fitted again. This cycle can be repeated indefinitely.



Figure 2.5 Shape Memory Polymer Snap Fit, Engineered for the EU Framework Five ADSM Project, 'Brunel University 2000

Shape memory polymers, being a Polyurethane based material, can be recycled in a variety of ways. Mechanical recycling of PU scrap involves size reduction/ shredding and then reprocessing into flakes or granules. These granules can then be used in conventional polymer processing techniques such as foaming re-bonding or moulding. PU scrap can also be used for chemical or thermal (energy) recycling³⁷.

2.4.10 Shape Memory Ceramics

Another non-metallic family of shape memory materials are known as the Shape Memory Ceramics (SMC). These materials show a clear shape memory effect, although they recover a significantly lower strain than that of other shape memory materials. There are two different types of SMC material.

2.4.10.1 Martensitic Transformation SMC

The first group of SMC materials are those that show a clear SME when undergoing a martensitic transformation. These are able to recover about 0.5% strain. The presence of partially stabilised ZrO₂ (PSZ) is a controlling component³⁸. Other components are MgO or CeO₂. The advantages of these systems over other shape memory materials is their high transformation temperatures (200-500⁰c), and their good stability at those temperatures. These are a true shape memory material and not a 'low-strain' Piezo/sensor material. However, like most ceramics, they are still susceptible to thermal and mechanical shocks, exhibiting a very brittle nature

2.4.10.2 PLZT Ceramics

A second class of SMC material can exhibit a shape memory effect based on changes in the magnetic domain size, like in PLZT (modified lead zirconate titanate) or on stress relaxation phenomena as reported in glass ceramics, some sintered ceramics and mica³⁹. Here the shape memory effect is limited to a few tenths of a percent and still very little is known about the recovery force. PLZT ceramics react at an incredibly fast rate (~1μs) although they do need a driving voltage of 500-1000v. PLZT materials are being used to create ceramic actuators for fuel injection systems. They are particularly suitable for injectors due to their resistance to high temperatures and pressures. They also react about four times faster than a comparable solenoid⁴⁰.

2.5 EXISTING SMART MATERIAL APPLICATIONS

2.5.1 Introduction

The materials detailed in the previous section are all commercially available, and have been proven in existing applications. Each of the material applications have been investigated to assess that materials suitability for use in an automotive assembly.

2.5.2 Thermochromic and Photochromic Inks

As already mentioned, thermochromic and photochromic inks have been used in a wide variety of novelty items. However, since their creation in the 1970's, they have also been used extensively for security applications. They can be used for validating tickets under special light conditions, or to prevent forgeries of documents or currency. The photochromic effect (or thermochromic effect) causes no change in the rheological behaviour of the fluid. This is illustrated by the use of photochromic fluids as a 'trace' material in a fluid dynamics experimental situation. An example of this is where the flow of a fluid system needs to be analysed in a lab environment. A photochromic ink is added to the fluid system and the fluid is then 'marked' by a short burst of UV light. This creates straight dark lines on the fluid and allows observation of the change of the fluid as a body in a system. It is imperative that the colour change causes no rheological change in the fluid system⁴¹. As these inks are not currently used in any structural assemblies, it is unlikely that they can be used to aid the swift assembly and disassembly of automobiles.

2.5.3 Electrorheological and Magnetorheological Fluids

Unlike thermochromic and photochromic inks, due to the rapid viscosity change enabled by magnetorheological and electrorheological fluids, structural applications are possible. Suspension systems can be made to almost instantly stiffen under cornering and braking forces, and adaptive systems lead to better ride control⁴². These fluids are also used in some pressure sensing devices, where differing forces of contact in a multitude of places can be accurately logged by the electrical signals created (i.e. Products such as Tekscan). These fluids open up the possibility for creating a means of actuator release due to a viscosity change, and also a means of creating selectively collapsible systems.

2.5.4 Magnetostrictive Applications

Terfenol-D has had its greatest commercial success in the form of the Newlands Scientific 'Soundbug'. This device encapsulates a rod of Terfenol-D and drives it in exactly the

same way that a speaker cone is driven by a magnetic field. Because the Terfenol responds to the magnetic field so quickly, and it has very little inertia, the sound quality is good. The major difference when compared to a conventional speaker is that the Terfenol can not move as far, but it can move with far more force. The Soundbug can therefore be placed on any surface, which is then 'vibrated upon' with significant force, turning it into a speaker- a window being a good example.

Actuators can also be produced with Terfenol-D. The design of these devices is straightforward. The idea is to squeeze a rod of Terfenol-D into a metal tube, the bore of which is slightly smaller than the rod's diameter. Then, a series of electromagnetic induction coils is wrapped around the tube (or stator), and the coils are used to generate a moving magnetic field. This causes a wavelike field to be produced down the successive windings of the stator tube. As the travelling magnetic field causes each succeeding cross section of Terfenol-D to elongate, then contract when the field is removed, the rod will actually "crawl" down the stator tube like a worm. Repeated propagating waves of magnetic flux will translate the rod down the tube's length, producing a useful stroke and force output. The amount of motion generated by the material is proportional to the magnetic field provided by the coil system. This type of motive device, which features a single moving part, is called an elastic-wave or peristaltic linear motor. These specifically have been used to good effect in variable geometry wing tips on aircraft⁴³. *Anjanappa* also validates the suitability of Terfenol-D for an actuator material by detailing that they are able to induce an energy density of up to 25 MJ m^{-3} in a magnetic field, with extremely fast response, in the region of 2-milliseconds⁴⁴.

2.5.5 Magnetic Shape Memory

Ni-Mn-Ga is the first MSM material that has been commercially developed, and is produced by AdaptaMat Ltd⁴⁵. MSM materials can combine large and complex shape changes coupled with the fast and precise response allowed by magnetic control. As with

most other actuator materials, there is the possibility to directly use the force and motion of the MSM mechanism, without using additional motors and gearboxes. Some applications where MSM materials and actuating devices can be used include fluid control (valves, pumps {see figure 2.6}, micro-pumps), positioning devices (robots, manipulators), shakers (active vibration damping, vibrators, ultrasonic washers, loudspeakers), mechanical couplers (brakes, couplings), sensors (position, field/force) and power generation.

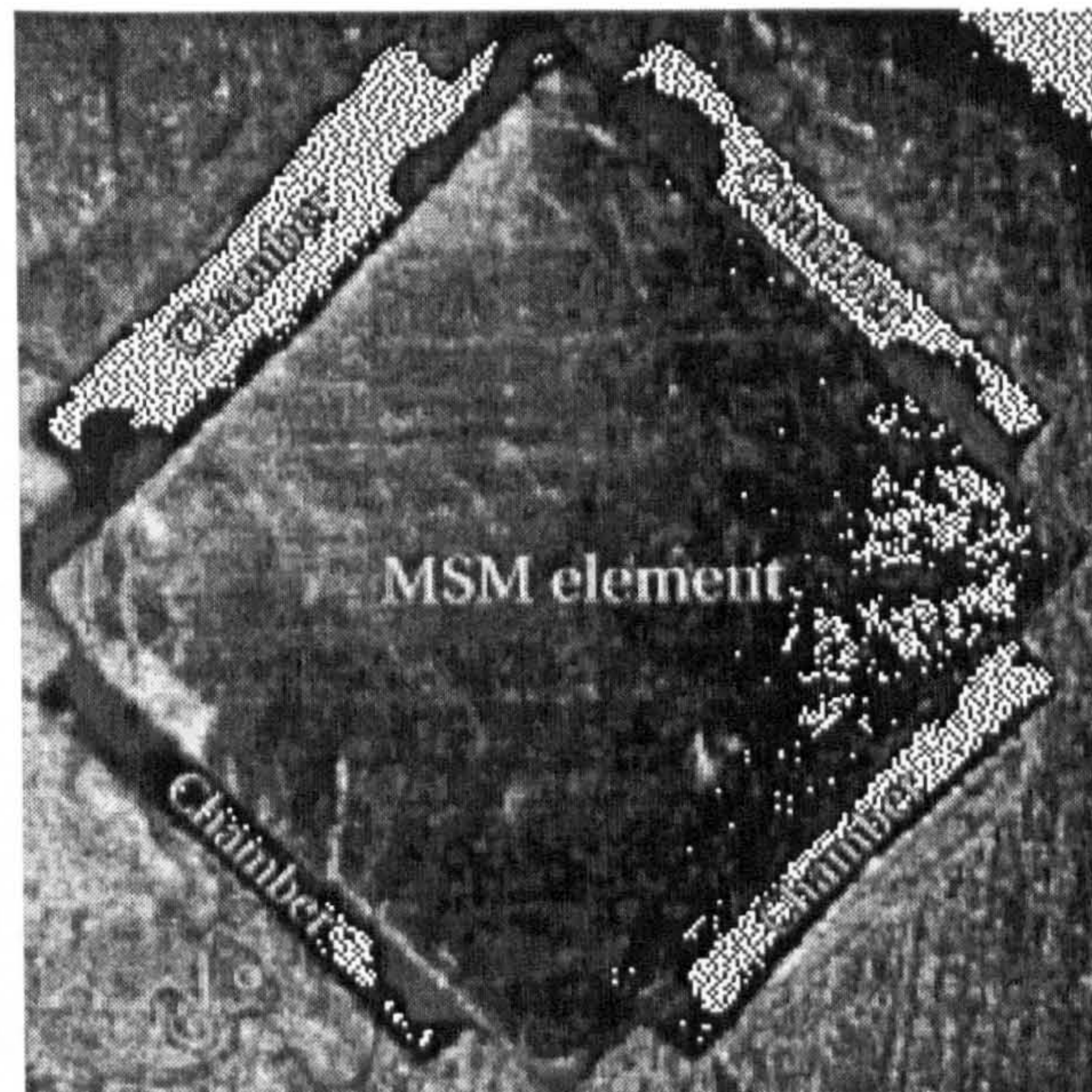

Figure 2.6 MSM Pump Chamber. The rotating magnetic field in the pump body distorts the MSM element, causing a change in each pump chamber volume, thus creating a pumping effect. Figure courtesy of AdaptaMat Ltd.

2.5.6 PVAXX

PVAXX packaging material has been used in applications such as such as burger boxes, pill capsules (due to its non toxic nature), and biodegradable disposable packaging.

PVAXX samples for investigation and prototyping have a shelf life of only six months so it can be deduced that the long-term robustness of a product constructed from this material will be questionable. Also, currently, no high ambient temperature samples of

the material are available and although higher temperature samples are under development, these are not available for testing outside the company.

2.5.7 SMA

As shape memory alloys exert a force when they change shape, and in their super-elastic form they can be used as 'Muscle Wires'. Muscle wires 'twitch' in contraction when an electric current is applied to them, so they can be used in replacement of motors and solenoids. According to the NiTi manufacturer Dynalloy, SMA devices can also be some 1000 times smaller than a comparable solenoid. Muscle wires can also be used to provide a significant restraining force on an object when they contract and undergo their SME. Due to their high force exertion, SMA's can be used to replace conventional fixings in weight critical applications, such as on spacecraft. Their performance and corrosion resistance is also important in harsh environments. They are acoustically and electrically quiet.

The first commercial application of SMA's was on the Grumman F14 fighter plane in 1971. As a weight saving exercise they were used in the form of 'cryofit rings' (produced by Raychem Corp.), to join titanium hydraulic pipes. SMA rings can also be used for EMC shielded terminations to metal braided electrical cabling. Again, in this application the collar used is oversize and therefore has 'Zero insertion force', but it grips the cable extremely tightly once warmed. The device can then only be released by cryogenically cooling to -160 degrees C with a liquid such as nitrogen. In these cryogenic applications the NiTi is usually further alloyed with Fe to suppress martensitic growth and hence relaxation of the coupling at low ambient temperatures. Similarly, Niobium can be alloyed with NiTi to produce high temperature 'repair' couplings⁴⁶.

SMA's are used extensively in the medical industry due to their biocompatibility⁴⁷, and their useful trait of being able to be made very small, and then expanded once in the body.

An example of this is a vein expander used to increase blood flow around clots, or alternatively to trap clots in the vena cava (*see figure 2.7*).

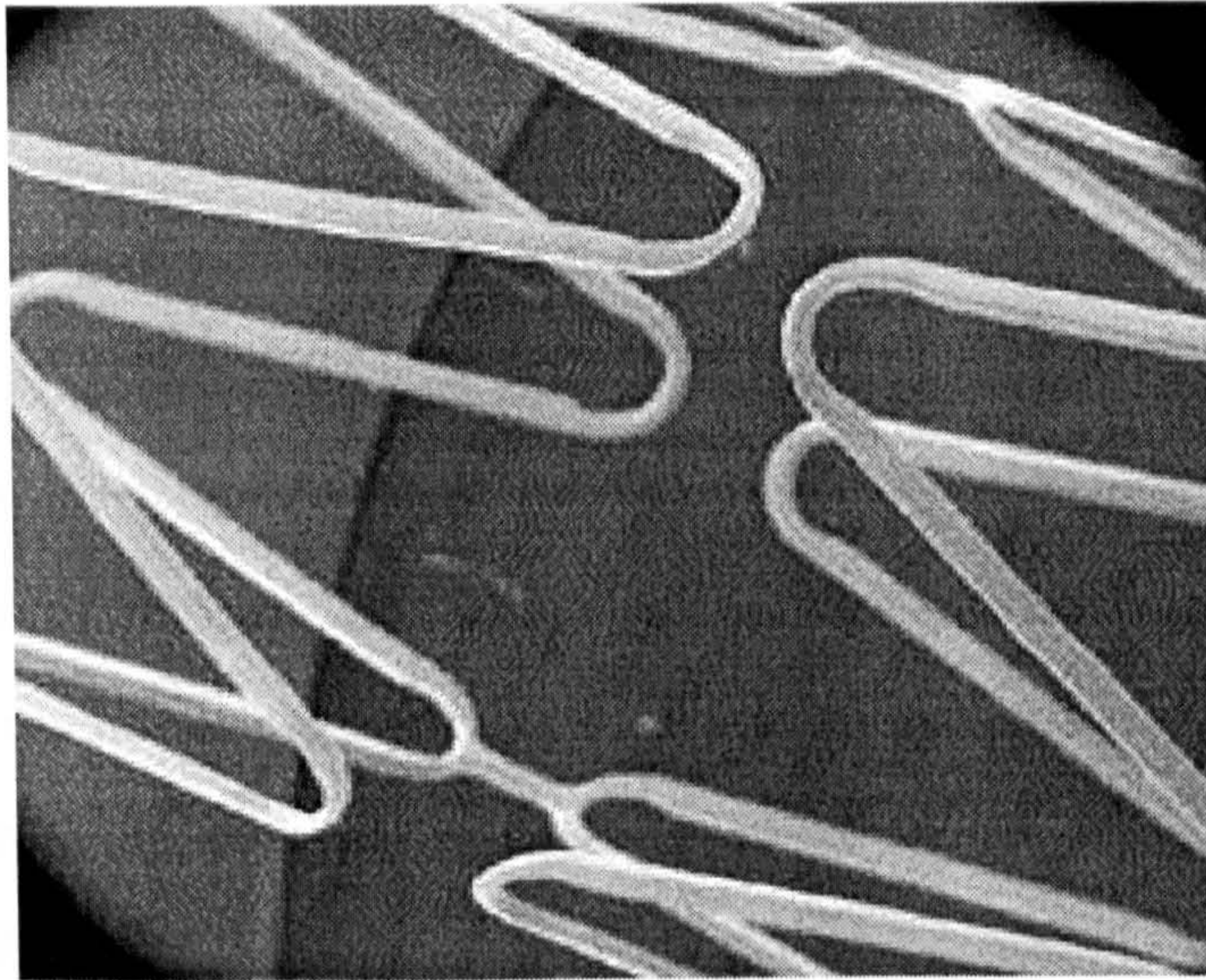

Figure 2.7 SMA Stent, Used to Expand the Vein Around Blood Clots

Picture courtesy of SMA-Inc.

The High forces that can be exerted by the shape memory effect of SMA can also be used to fabricate staples used to hold and push bone fractures together. The staple is trained in the form of a 'part closed' staple. When this is 'opened out' and pushed into broken bone pieces, body heat warms the staple above its transition temperature, causing the staple to close and push the bone fragments together with significant force⁴⁷.

2.5.8 SMP

Shape memory polymers have not yet had the same level of commercial exploitation as SMAs. Currently, SMP's are used for ergonomic handles on knives and forks for people suffering from arthritis and limited muscular power. The handles are warmed in hot water, and the user is then able to mould the handle to suit their hand.

The nature of the material change at T_g also opens up the possibility to use the material as a breathable fabric. The US Army's Soldier and Biological Chemical Command Lab in Natic, Massachusetts, has been experimenting with SMP drysuits. At 13-18°C the material has a dense molecular structure, keeping the wearer warm. Between 18 and 27°C, the material becomes more amorphous and supple allowing sweat to emerge from the suit. The wearer is also able to urinate in the suit without it degrading- a useful property for Navy seals during long sorties. The drysuit is slightly heavier than existing drysuits, but it eliminates the need to carry a separate change of clothes. This is because of its breathable nature, the suit can still be worn on land without the wearer overheating as you would in a normal drysuit. Further applications can involve anything concerning water, i.e. suits for divers, surfers or water rescue personnel⁴⁸. The Japanese manufacturer of SMP fabric *Diaplex*, also manufactured breathable suits for the Japanese Winter Olympic Ski Team, operating on a similar principle⁴⁹.

As with most Shape memory applications, medical research has been a strong driver. SMP threads have been used for some time in endoscopic surgery in confined spaces where tying stitches is a difficult operation, and damage to surrounding tissues must be avoided. By using an SMP thread, knots can be made to 'self tighten' by contraction of the SMP material when heated to 37 degrees by the body⁵⁰.

2.5.9 Shape Memory Ceramics

Shape memory ceramic applications have so far been somewhat limited due to the fact that the material only shows good performance in certain conditions³⁸. Like all other ceramic materials, SMCs are brittle and subject to failure when exposed to mechanical or thermal shock. Also, due to their low recoverable strain values, mechanical applications are also limited. Although the force available upon actuation is quite large, mechanisms can be constructed (such as lever mechanisms), to increase movement or stroke at a device, at the expense of applied force³⁸. However, like most other ceramic materials,

their high temperature stability and oxidation resistance is excellent. Coupled with sub-microsecond response times, they are particularly suitable for use in fuel injectors for internal combustion engines⁴⁰.

2.5.10 Material Summary

In summary the materials that are most interesting from an automotive assembly/disassembly perspective are those that can readily be used to apply force, or used in retention mechanisms. What are required, are adaptable materials that are capable of retaining structural integrity in a wide variety of automotive environments. The most appropriate materials are:

- Magnetostrictive materials
- Shape Memory Alloys
- Shape Memory Polymers.

2.6 METHODS FOR TRIGGERING ACTIVE DISASSEMBLY

2.6.1 Introduction

Currently, active disassembly has been triggered by a variety of thermal means, with varying degrees of success. An overview of different actuation methods was conducted to qualitatively assess the amount of potential energy consumption (and wastage), and the suitability of the actuation method to be applied in an automotive context.

2.6.2 Hot Air Gun

The simplest method for activation has been by direct heating with a hot air gun, relying on thermal conduction and convection to heat the part until the Shape Memory Effect occurs. There are several problems with this method:

- The fastener device is usually, for aesthetic and structural reasons, encapsulated deep into the host product. Heating with air can significantly raise the surface temperature of the product, but not elevate the interior of the product to the same level, making activation difficult

- It is difficult to accurately direct the hot air stream, so damage to the rest of the product usually occurs during triggering
- The heat conductivity of air is poor, and large metallic parts can act as heat sinks. Actually achieving the required temperature rise can therefore be difficult
- Poor energy efficiency is achieved due to the misdirection of the air stream, and energy wasted in heating unnecessary parts
- Individual manual operation is usually required to orientate the assembly and direct the air-jet⁵¹.

However, some of these problems can be minimised. By designing air channels into the host product, thermal convection can be encouraged. Also, by using 'heat-sinking' materials such as Aluminium, 'thermal-rails' or 'bus-bars' of heat can be created. Fasteners in contact with these rails are then directly heated and triggered.

2.6.3 Fluid Immersion

Fluid immersion can be a simple way of triggering large quantities of small host items such as small electrical and electronic products. By dropping the product into a hot tank, the entire product is easily evenly heated and disassembly can occur. Water is usually a suitable media for electronic products as many components such as LCD screens are sensitive to high temperatures. For applications requiring higher temperatures, an oil bath may be used. Theoretically, there may be problems with the dissolution of hazardous materials such as Mercury into the heating tank and this would need to be resolved.

From a simplicity point of view, this option is attractive. However, as part of the object of the exercise is energy reclamation, heating large masses of redundant material is wasted energy. Also, the water tanks must be well insulated to avoid unnecessary heat loss. This method is not practical, and would not be efficient for very large assemblies such as an automobile. It could however be useful for automotive subsystems and assemblies, such

as a control panel module or an electronic control unit. No manual intervention is necessarily required to aid heating, although a vibrator or shaker in the water tank can aid part separation.

2.6.4 Induction Heating

Induction heating is an attractive proposition for plastics based products, as only the metallic elements will be heated. Unlike the fluid immersion system, large masses of plastic will remain unheated other than by conduction from adjacent metallic components. This method is ideal for heating encapsulated SMA (*and therefore metallic*) actuators inside a plastic component.

There is also the possibility of creating ‘targeted’ plastic parts for inductive heating by using carbon-doped polymers. Induction heaters will also influence conductive polymers, so the development of conductive SMP’s could be a possibility for disassembly. Again, no manual orientation of the part is necessarily needed, although shakers would aid part separation. This technique has been investigated by Huuhtanen of Nokia⁵².

2.6.5 Microwave Heating

The principle advantage of microwave heating is that like induction heating, it facilitates the targeting of materials that are able to absorb microwave radiation. Coupled with induction heating, the possibility of hierarchical disassembly becomes a reality, as a ‘disassembly line’, is able to target components of one particular type of construction, and then target alternative component types by utilising an alternative actuation mechanism. However, specific components inside experimental assemblies absorb microwaves in preference to others, resulting in sparks or fire- before the smart materials reach their triggering temperature⁵¹. Further research is therefore required to optimise component design for microwave actuation, and guidelines for ‘design for microwave actuated components’ would be beneficial.

2.6.6 Infra Red Conveyor

The evolution of the Active Disassembly process has necessitated consideration to be given to the scaling up of the disassembly process. Although the disassembly of individual products is important for prototyping and investigative purposes, it bears little resemblance to an industrial scale disassembly operation, such as that undertaken after the reclamation of collected disposable cameras.

A conveyor belt system was experimented with- utilising infrared heaters above a slow moving steel mesh belt. The success was limited, and much damage occurred to the product casings due to excess heating. The mean time for disassembly was also quite long at around three minutes⁵. This system is certainly more suited to products that have been designed with careful consideration to Design for Assembly (DFA) principles- as these products will typically assemble from one orientation. Therefore they *should* disassemble along that same axis of orientation, and not require repositioning on the line. However, the disassembly line still has the limitations listed above for the hot air triggered products, in that there was a large amount of wasted energy going towards heating up the surrounding environment. Again, these candidate products also suffered from a lack of thermal conduction to the actuator mechanism and some of the products were damaged. This process could also benefit from shakers to separate the product pieces once separation has occurred

2.6.7 Laser Heating

So far laser heating for disassembly has only been experimented with by Nokia⁵³. It does appear to be a very feasible concept. In keeping with the wish to achieve low energy consumption, laser heating targets the required area for stimulation very effectively, with minimal heating of the surrounding area. For this method to be practicable there would need to be a serious investment in disassembly plant. Focused heating requires a specific 'target' for the laser, so this means either the EoL parts have to be carefully aligned on the

disassembly system, or that a recognition system would be needed on the disassembly line to focus the laser on the desired area. There are also safety issues regarding the use of lasers. Operators would have to be protected from the lasers and from their associated radiation.

2.6.8 Summary of Triggering Methods

In keeping with the spirit of the ELV directive, energy usage during triggering must be kept to a minimum. Therefore, when developing a Product Design Specification (PDS) for future retention systems, *activation* energy must be kept to a minimum. Any heating methods employed must be 'direct', and not involve elevating the temperature of other parts of the product. Induction heating, Microwave Heating and Laser heating are therefore all suitable actuation methods

2.7 DESIGN PRINCIPLES AND METHODOLOGIES

2.7.1 Introduction

Designers can use many tools to evaluate design solutions- both retrospectively, and during the design process. For these tools to be of use, they must provide a fair means of quantitatively comparing one design to another, and allow the designer to establish where improvements can be made. Typically, design methodologies are 'cost' based, as improvements lead to economic rewards once production is undertaken. From a Design for Environment (DfE) perspective, these economic savings also usually correspond to an associated energy saving. Further to this, decreased costs achieved by efficient product assembly can also aid the disassembly of the product. A brief summary of some design methodologies was completed to evaluate which methodologies could be of use when designing for vehicle *disassembly*.

2.7.2 Design for Assembly Principles

It must be appreciated that Design for Assembly (DFA) is rarely considered on its own. It is considered along with many other formal evaluation methods during the development of a product. These can be illustrated by Figure 2.8:

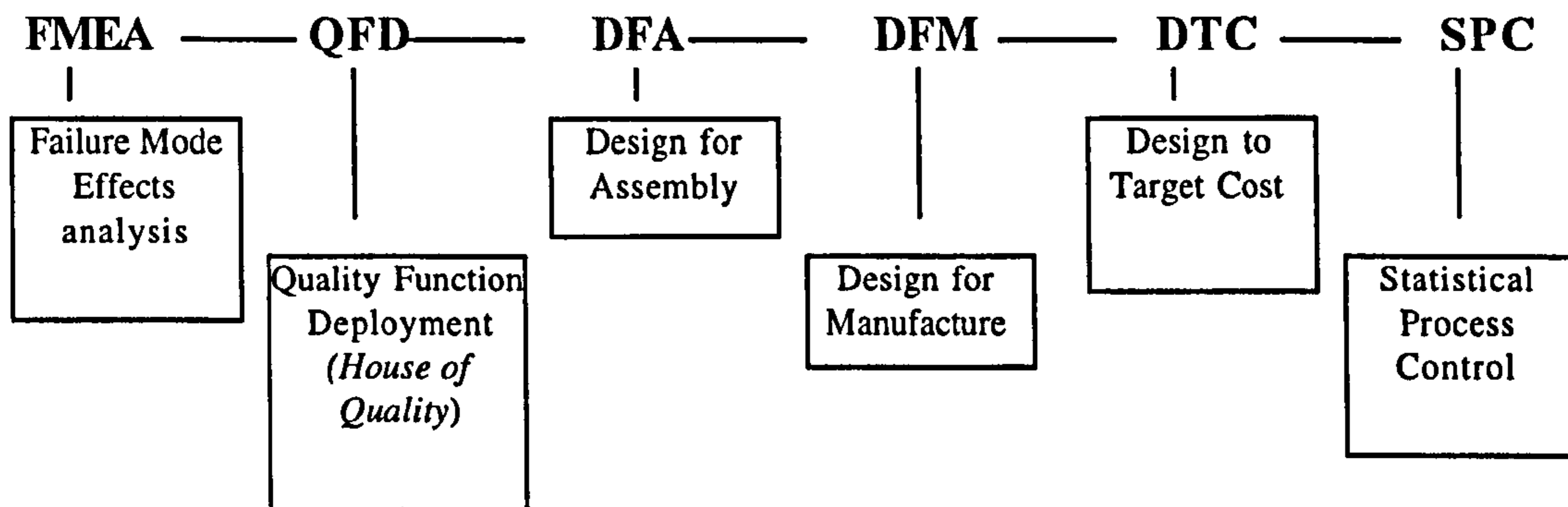

Figure 2.8 Formal Evaluation Methods used for Design Evaluation

It is logical that ‘design for *disassembly*’ (*DfD*) principles should follow design for *assembly* principles; disassembly being the natural eventual progression from assembly. Design for assembly is critical for consideration in a successful product as assembly typically takes more than half the time of manufacture, whilst accounting for 20% of production costs⁵⁴.

Many methodologies have been created to optimise design efficiency, and to quantify design efficiency as a percentage. These include the Boothroyd and Dewhurst (B+D) product design for assembly methodology, the Hitachi method and the Team SET method.

2.7.2.1 Boothroyd and Dewhurst Method

The Boothroyd and Dewhurst methodology addresses all the problems of determining the appropriate assembly method, reducing the number of parts that must be assembled, and ensuring that the remaining parts are easy to assemble.

The designer must decide from the values of the basic product and company parameters (number of parts, production volumes etc.) which assembly method will be most economic. Assessments are achieved by assessing chart summaries of various operations, using tables based on analysis of mathematical models of the various assembly processes.

The most powerful tool of this or any other DFA system is the reduction in the number of parts required for the product to be functionally acceptable. The secondary, but extremely effective tool, is a system based on systematic penalties for particular activities. By posing the question “How does what I am attempting to do compare with how it could be done if every aspect of the part design favoured the activity?”, quantitative judgements can be made and the user has the opportunity to view easily the re-design options available⁵⁵.

2.7.2.2 CSC Design for Assembly Method (*formerly the ‘Team SET/ Lucas’ Method*)

The Lucas DFA method arose out of collaborative work between the Lucas organisation and the University of Hull. The first computer based version of the methodology was launched in 1989. The system is meant to be integrated into a CAD system, and obtain most of the information required in the minimum of time. This is a significant advantage over most other systems that effectively stand-alone. The strategy of the evaluation rules is implemented using the programming language ‘Prolog’.

As the product design commences, it is decided whether the product is unique or whether there are similarities that represent opportunities for standardisation. This is a useful feature as the DFA system effectively offers guidance.

Function analysis is completed on each part together with an evaluation of part motion, material properties and assembly issues. Each activity is then deemed to be either essential (A), or theoretically non-essential (B). The design efficiency is then defined as the ratio of category A activities to all activities ($A/(A+B)$), and if the efficiency is low, a re-design may be prompted. A suggestion of the design efficiency threshold is 60%⁵⁵.

2.7.2.3 Hitachi AEM (Assembly Evaluation Method)

Hitachi Ltd. developed their AEM as an efficient tool to improve design quality for assemblability. Since then it has been widely used by the Hitachi group and many other companies, as it is considered to be one of the more effective methodologies.

Assembly operations are categorised into approximately 20 tasks, relating to insertion and fastening- not part handling. Each task is subject to a penalty score that reflects the degree of difficulty of the task. The sum of the various penalty scores are then modified by attaching a co-efficient, and then subtracting them from the best *possible* score of 100. This gives an assembly evaluation of the part.

The total assembly evaluation score for the product is now defined as the sum of the assemblability scores for the individual tasks, divided by the number of tasks. This may now be considered a measure of design efficiency, where a score of 100 would be perfect. Hitachi consider an overall score of 80 to be acceptable.

Later versions of the methodology include an evaluation of disassembly costs. This was found to be useful on a purely comparative basis, although more accurate and realistic cost forecasting would have been desirable⁵⁵.

In summary, the three methodologies aim to orientate parts to minimise assembly time, but to also minimise the *numbers* of parts by questioning if the part is truly necessary. Minimising parts and operations will reduce energy consumption in manufacture and production. These principles are illustrated by figures 2.9- 2.12.

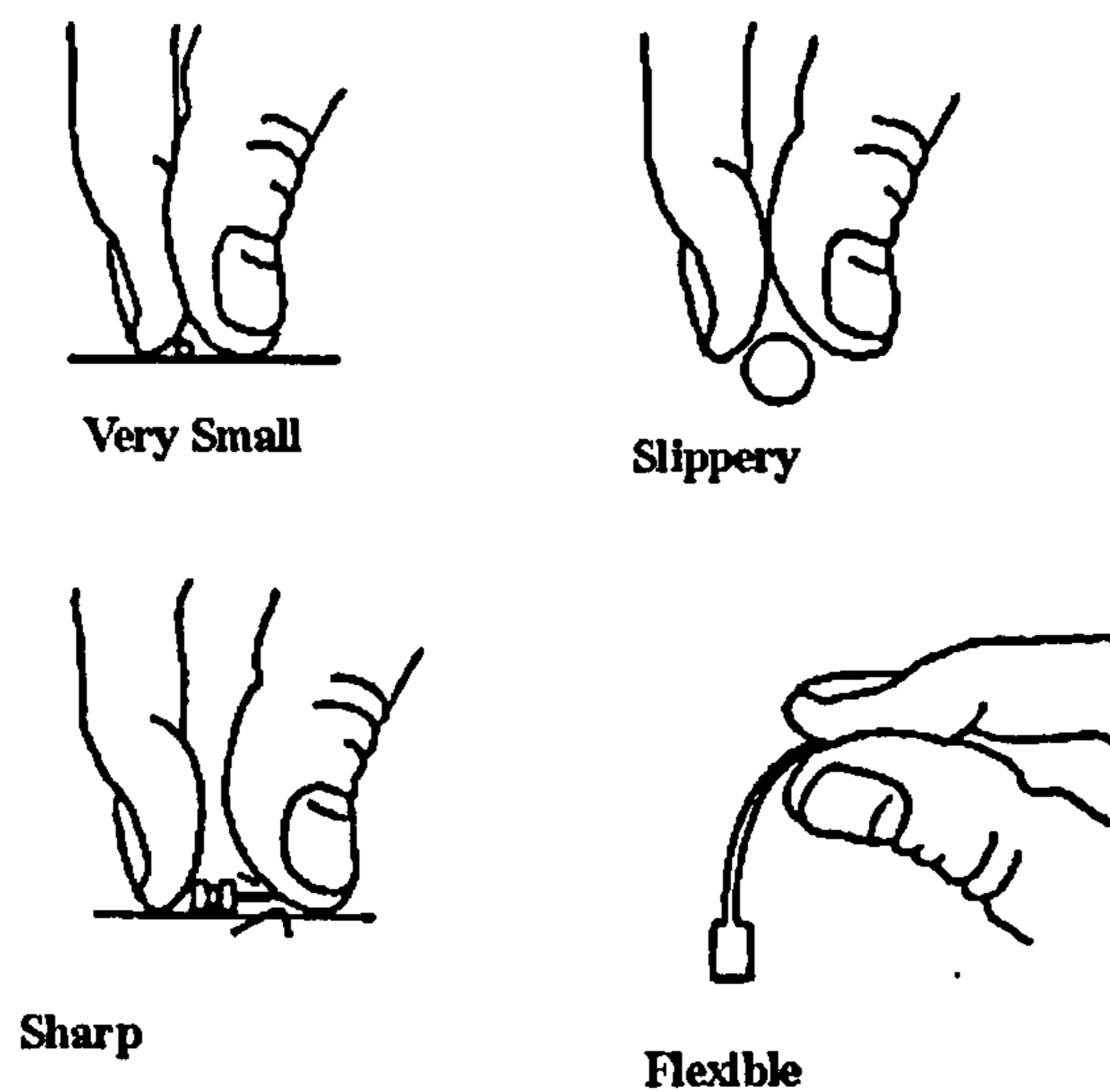

Figure 2.9 Features Making Part Handling for Manual Assembly Difficult⁵⁴.

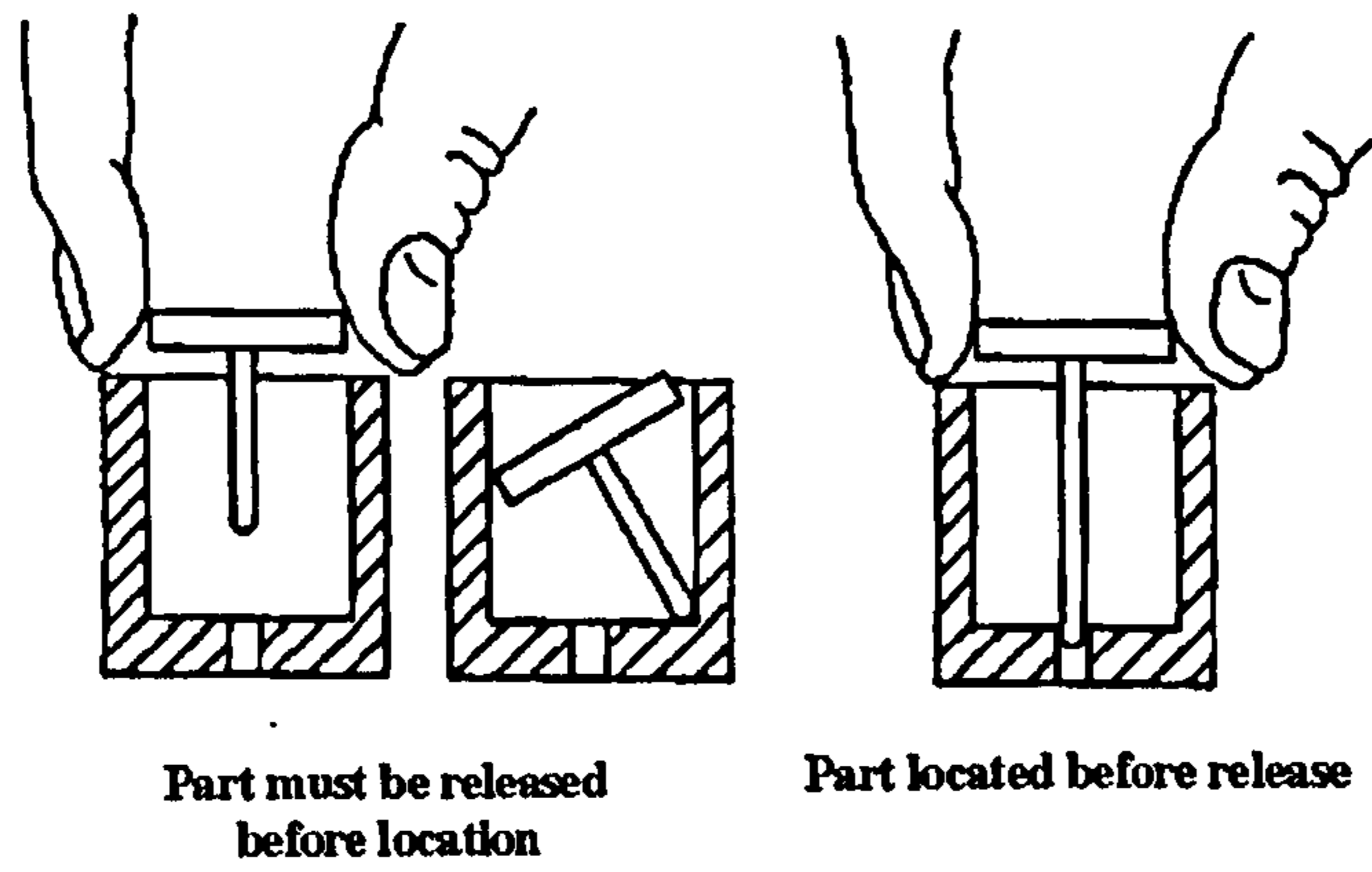

Figure 2.10 Design to Aid Insertion, and thus Assembly⁵⁴

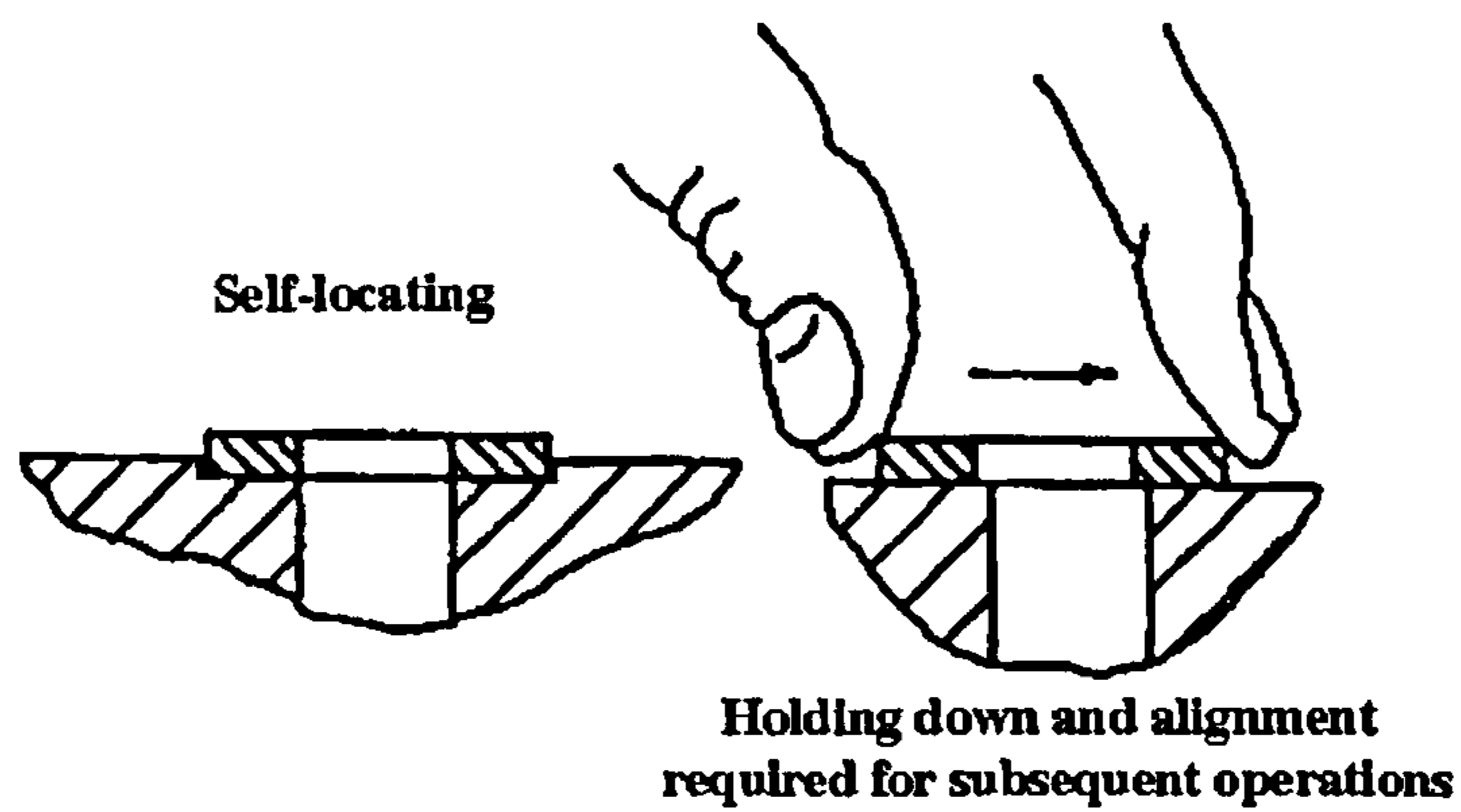

Figure 2.11 Provision of Self Locating Features to Aid Alignment During Assembly (*Fast Assembly*)⁵⁴

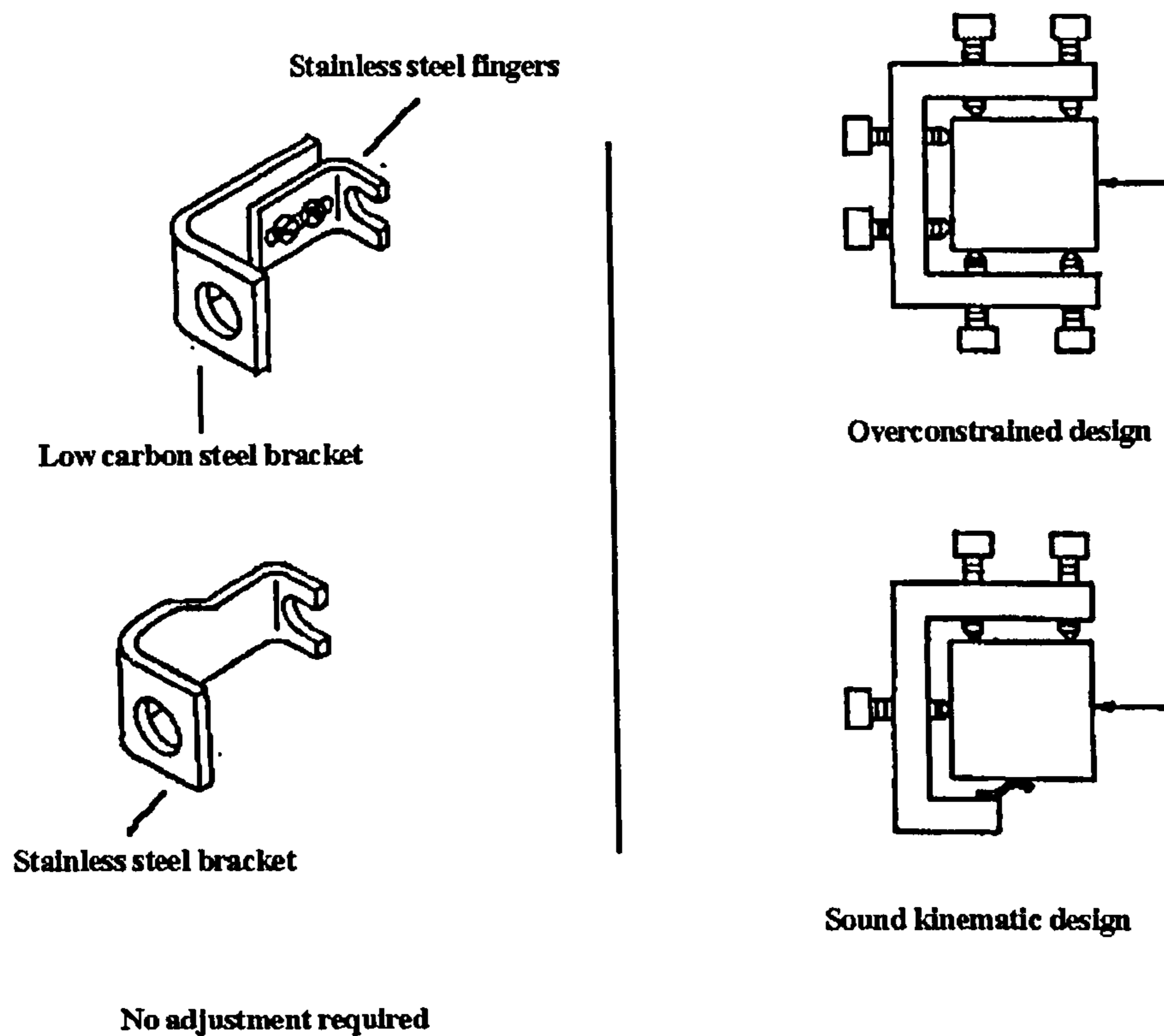

Figure 2.12 Minimising Parts to Eliminate Fine Adjustment and Aid Reliability⁵⁴

2.7.3 Design For Disassembly

Following on from DFA comes the research on Design for *Disassembly*. It was identified in 1996 that there were thirteen research groups active in the area of DfD⁵⁶. However, most of these work groups based their principles and methodologies on observations of DFA principles in reverse. The number of research groups will have now risen, with institutions such as Brunel University (*Active Disassembly*) and the University of Tokyo (*Reversible Interconnects*)^{69, 70} leading the way with innovative alternative design solutions.

2.7.3.1 The Selection of The Dowie DfD Methodology

As stated in section 2.3.3, generally existing DfD methodologies centre on organising a disassembly system to deal with specific existing products^{96, 97, 98}.

Together with analysing DfD principles (in a similar way to the way products can be designed and evaluated from a DFA perspective), a DfD methodology was sought that would also quantifiably assess existing product designs from a DfD perspective. An analysis technique was required that is *generally* applicable, unlike ‘case based’ work⁹⁶ which centres on deriving a disassembly solution for particular scenarios. A methodology such as this was created by *Dowie* from *Manchester Metropolitan University* in 1995. This methodology can then be applied to vehicles at a car dismantlers- a scenario very different to a reverse production line.

Dowie’s thesis on ‘A Disassembly Planning and Optimisation Methodology for Design’⁵⁷, states that for proposing a DfD methodology, guidelines are a good starting point. DfD guidelines are particularly important, as DfD is a relatively new concept to most designers (table 2.1). Parallels can be drawn with assembly, and the guidelines are listed as below and overleaf:

A. Materials
1. Minimise the number of different types of material
2. Make sub-assemblies and inseparably connected parts from the same or a common material
3. Mark all plastics and similar parts for ease of identification
4. Use materials that can be recycled
5. Use recycled material
6. Ensure compatibility of ink when printing on plastic parts
7. Eliminate labels on incompatible plastic parts
8. Hazardous parts should be clearly marked and easily removed

B. Fasteners and connections
9. Minimise the number of fasteners
10. Minimise the number of fastener removal tools required
11. Fasteners should be easy to remove
12. Fastening points should be easy to access
13. Snap-fits should be obviously located and able to be disassembled with conventional tools
14. Try to use fasteners of material compatible with parts connected
15. If two parts can not be compatible, make them easy to separate
16. Eliminate adhesives unless compatible to both parts joined
17. Minimise the number and length of interconnecting wires or cables used
18. Connections can be designed to break as an alternative to removing fasteners
C. Product Structure
19. Minimise the number of parts
20. Make designs as modular as possible, with separation of function
21. Locate unrecyclable parts in one area that can be quickly removed and discarded
22. locate parts with the highest value in easily accessible places
23. Design parts for stability during assembly
24. Avoid moulded-in metal inserts or reinforcements in plastic parts.
25. Access and break points should be made obvious

Table 2.1 Design for Disassembly Guidelines ⁵⁶

Dowie's 'Guidelines for Design for Disassembly' can be summarised as being:

- '1. Materials- Enabling the disassembled materials to be easily recycled but the principles can apply equally to disassembled parts for re-manufacture of re-use
2. Fasteners and Connections- enabling quick and easy disassembly
3. Product Structure- enabling rapid and economic disassembly.'⁵⁶

With respect to these guidelines, it is in the second category (*fasteners and connections*) that the work of *Brunel* and *Tokyo* revolves. However, to incorporate the new connection systems, consideration must also be given to point three (*product structure*); in which case point three has to be exploited fully also. It must therefore be concluded that with the examples of *Brunel* and *Tokyo*, product structure has to follow the lead of ‘new fastening solutions’, and not vice versa.

2.7.3.2 DfD Methodology

Essentially, a time/ task analysis is conducted on a product to evaluate its DfD potential. For example: Screw removal times are based around a calculation of thread pitch against length, to establish the number of revolutions required for removal. This quantification then allows a number to be entered into the calculation matrix. Naturally, other operations are evaluated also, such as clip removal, cutting, breaking and disconnection operations, and tool changing. These operations are all allocated operation times that are used in calculating a product disassembly time. It is interesting to note that, for example, using a tool to open a snap-fit doubles the time for that disassembly operation when compared to manually breaking the fixture. This is because a tool location time has to be allocated along with the actual ‘un-snapping’ operation. This example illustrates how the methodology analysis operates.

Consideration is also given to the fact that complete disassembly is not always necessary. For example, if two snapped together parts are made from compatible plastics, further disassembly may not be required.

Dowie's methodology can be applied in at least 3 contexts:

1. To establish an optimum amount of disassembly; to maximise profit from products that were not designed for disassembly
2. The application of the methodology to ease disassembly during a product re-design
3. New product design. To ensure designers are aware of DfE issues and are given guidance in the incorporation of DfD principle ⁵⁷

2.7.3.3 Problems with a DfD Methodology

Dowie does acknowledge that this methodology is not flawless, particularly with regard to context 1 above. Recycling infrastructure- like any infrastructure- has to be based around economic reason. The methodology can not predict future recycling revenues. If DFD is incorporated for maximum recycling profit, the expected return can not be guaranteed. Break-even points will therefore float in accordance with scrap values ⁵⁷.

Other limitations also occur as a result of the lack of availability of this knowledge to the design community, where methodologies such as the Boothroyd and Dewhurst methodologies are widespread (*the implication of this methodology primarily being concerned with product 'cost-downs'*). The *Dowie* methodology is still confined to the pages of a thesis. Even then, should a designer wish to follow the DfD calculations, data such as material compatibility is missing, and economic factors are acknowledged as being out of date.

2.7.4 Design for Recycling

Together with consideration for design efficiency, design for assembly and design for disassembly, should come consideration for design for recycling.

The German DIN standard identifies the more detailed areas associated *with Design for Recycling*, these are:

- Designing for ease of disassembly, to enable the removal of parts without damage
- Designing for ease of purifying, to ensure that the purifying process does not damage the environment
- Designing for ease of testing and classifying, to make it clear as to the condition of parts which can be reused and to enable easy classification of parts through proper markings
- Designing for ease of reconditioning, this supports the reprocessing of parts by providing additional material as well as gripping and adjusting features
- Designing for ease of re-assembly, to provide easy assembly for reconditioned and new parts ⁵⁸.

Designing with consideration to all of the above criteria should ensure that all parts of a product could be reused to their full potential. However, *Beitz*⁵⁹ identifies that even if all materials are removed for recycling, care must still be taken to ensure that for example, aluminium types are not mixed indiscriminately, and again that plastic types are not mixed with incompatible types. The designer must ensure, if possible, that alloy and plastics types are selected to cause the minimum of problems given their likely route of recycling (I.e. shredder, manual disassembly, municipal collection)⁵⁹.

Although energy used for product disassembly is not discussed with relation to material energy recovered, *Henstock*⁶⁰ has undertaken perhaps one of the most broad assessments of design for recyclability. Although this work pre-dates any self-disassembly work, it is still nonetheless a valuable reference source. Unusually also, the work illustrates

particular automotive case studies. Although the work is slightly out of date with regards to economic issues, it is interesting to note that steel prices from 15 years ago, exceed their current levels. However, from a design perspective, the focus of the work is on modifying material selection for economic reclamation, rather than from a design for assembly standpoint. He does identify though, that on average 10-12 minutes is required to remove 88% of the Cu from within a vehicle. Most of this mass is concentrated in the radiator, dynamo (or alternator), starter, battery cable and heater components; any further reclamation taking in the order of 20 minutes to remove the remaining 12%, therefore it is not usually economically viable to do so. A need is therefore clearly identified as a means for aiding further removal. This remaining copper would be adding 0.17-0.27% Cu to the remaining hulk. Henstock also identifies that there is no known method for satisfactory removal for the instrument panel, and any copper containing masses lying behind it. This highlights areas of possible active disassembly application.

For areas containing a large mix of materials, it is sensible to group together parts constructed from similar materials (i.e., to attach the ignition coil and under-bonnet wiring to the radiator bracketry) so that they will be simpler and thus more likely to be removed for recycling.

Henstock identifies the barriers to complete vehicle recycling, as the removal of small Cu containing parts as prohibitively expensive. To close the loop for vehicle recycling, any proposed disassembly solutions must be thorough, fast and complete⁶⁰.

All these processes can be applied as eventual re-works and refinements to existing designs. Achieving an initial successful design solution against all these criteria would be difficult; but with careful re-evaluation of various designs, it should be possible to create solutions matching most of these criteria.

2.7.5 Design for Maintainability

Human factors engineering can be applied to systems design to minimise the time and effort required to perform periodic predictive maintenance tasks as well as unscheduled maintenance⁶¹. Along with industrial plant, automobiles also require a thorough and routine maintenance schedule. By incorporating ease of maintenance principles (ease of checking critical and non-critical fluid levels, ease of adjustment, access to consumable parts such as fuses), maintenance become easier and less likely to be skipped. This in turn leads to greater reliability, and reduced part failure. This is an ecological benefit in itself, in addition to the reduced inconvenience of not having to establish alternative arrangements when a failure has occurred.

2.7.6 Design for Modularity

DFMo is an important concept to be considered as it encompasses important design for assembly principles, along with a strong emphasis for overall efficiency. This efficiency comes with both the needs to maximise assets and minimise product wastage.

Modular products are products that fulfil various functions through the combination of distinct building blocks or modules. An automotive starter motor is a 'starter module' that can be used on a variety of 'engine modules'. Product modularisation may involve the creation of a basic 'core' unit to which different components (modules) can be fitted. This enables variations of the same model to be produced- such as 'federal specification', 'European specification', and 'Domestic specification' engine units, which vary in terms of power outputs and emissions. The core unit though (if incorporated), should be designed to cope with all expected variations and perhaps anticipation of the next generation of modules.

Modularity should promote: ⁶²

- Reduction in product development time
- Customisation and upgrades
- Cost- effectiveness
- Quality
- Design standardisation
- Reduction in overall lead time.

A modular design can be described as a design that decomposes a design problem into parts that are as independent from each other as possible. A modular design is usually adaptable with little or no modification for many applications. Design for modularity also promotes Eco-principles, by minimising waste through allowing the possibility for individual module upgrades. Hi-fi systems and computers are good examples of modular products that allow single unit replacement to upgrade the complete system.

Conversely, there are Eco-arguments *against* modularity. One argument is that modular products can have a high material usage by including fixtures that may not be used.

Another argument centres around redundant product infrastructure, by including 'function support' for features that are not necessarily purposeful in the final overall product ⁶².

Generic sockets and fasteners are of course critical in achieving modular systems. For new systems, the establishment of standard fastening patterns needs to be created, again with sympathy for likely product development and expansion. The design evolution process for design for modularity can be summarised by figure 2.13.

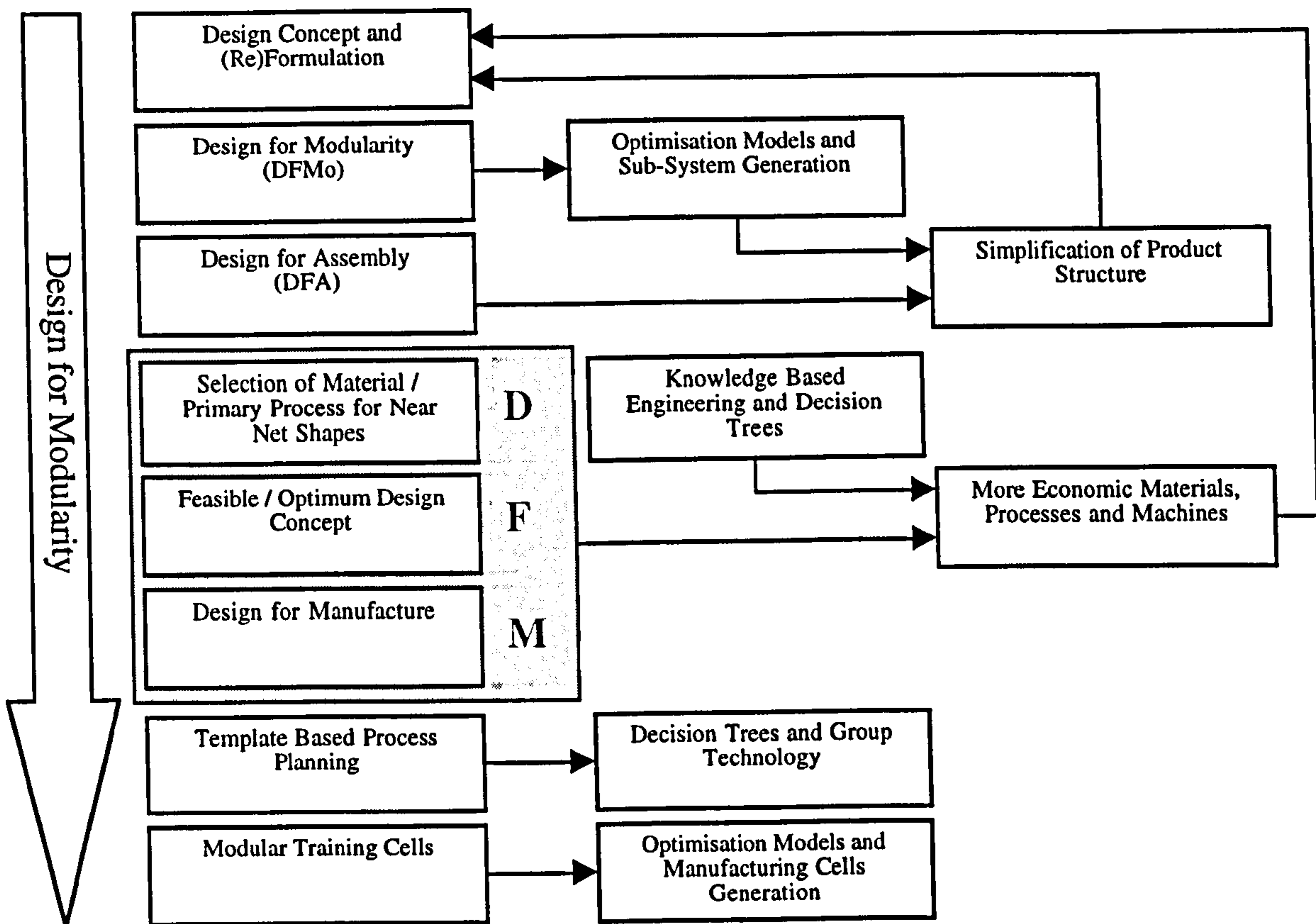
Figure 2.13 Design for Modularity Life Cycle ⁶²

Design for modularity is also connected to design for maintainability and repair. From a repair point of view, it will always be preferable to replace a small part as opposed to replacing a complete assembly. However, often due to the complexity of an individual part, labour time to disassemble down as far as an individual small part is often expensive. To again use the example of an automotive starter motor, replacing an armature bearing would not usually be an economically viable prospect. There would be first the labour involved in removing the motor. Then the motor has to be disassembled, and the bearing replaced, incurring the cost of the part. The motor is then reassembled and tested before replacement, and the part on the vehicle is still essentially an old motor. This is not usually a very efficient, or reliable prospect. Far better is to replace the motor swiftly as an individual module. The motor can then be exchanged by a motor factor. Exchange operations operate to overhaul such components so that all replacement parts used are of

an 'as new' quality. This then returns us to the principle that well maintained and reliable systems are of sound environmental value. This is again in keeping with the VDI guidelines for DfE⁵⁸, as it states the example of consumer recycling being based upon a system *refurbishment and remanufacture*.

2.7.7 Summary: The Application of Methodologies by the Designer

The principle of adding efficiency to a product system by encompassing design methodology is proven by the preceding case study examples; this is regardless of whether the technique is intended to have its major impact on either the *manufacturing* or *disposal* phase of the product lifecycle. However, designers can be reluctant to critically re-evaluate a product that they have spent so many man-hours on. This leads to so called 'ugly baby syndrome', where the designer continues to love the questionable design *regardless*⁶³.

This leads to the proposal that surely the design evaluations should be completed during the design stages, rather than at the evaluation stage- where change can be time consuming and costly. *Dalgleish et al*⁶⁴, propose exactly this; and although their proposal is for a DFA system, there is no reason that the principle cannot be expanded to include DFD, and DfE principles. Dalgleish states that designers would rather have tools that can be used earlier in the product introduction process to quantitatively assess design solutions to allow them to pursue those more likely to lead to *competitive* products. Designers would also prefer 'single dose' analysis, rather than constant re-evaluation using many tools. This way designers are more likely to take a pro-active approach to design methodologies. By incorporating the tools into a modern CAD system, the terminal is able to provide the analysis. Initial development work effectively included the following:

- *Product structure experts*- giving guidance on minimising variants
- *Assembly sequence experts*- giving advice on 'start' components and 'next' components in sequence generation

- *Assembly process experts*- giving advice on insertion, material compatibility and joining processes.

This technique therefore implemented DFA in a more positive ‘feed forward’ way, and could later be expanded to incorporate other DfE methodologies⁶⁴.

2.8 EXISTING WORK ON ACTIVE DISASSEMBLY

2.8.1 Brunel University

Work on ADSM at Brunel University began in the early Nineties, by *Billett et al* and was funded initially by the EPSRC⁷³, and later the EU (2000). The majority of the publications in this area have been by *Chiodo, Billett et al*^{5, 6, 7, 23}. The ADSM work at *Brunel* up has been completed by the ADSM team working in the ‘Cleaner Electronics Research Group’ on the disassembly of consumer electronic products. Published disassembly solutions include self-disassembling mobile telephones⁵, clock radios⁷ and calculators⁶⁵. As the ADSM work began to achieve international recognition, the research undertook a more commercial design philosophy, and the *Brunel* team proceeded to coordinate the Framework Five EU funded research programme. The results of the EU research programme will begin to be disseminated towards the end of 2003.

This investigation into vehicle recycling represents the first diversification from the electronics based work.

2.8.2 CRT Disassembly

Although not usually referred to directly as ‘active disassembly’, there are several world-wide projects underway to aid product Disassembly at EoL. One such project is the “Product Embedded Disassembly Process”⁶⁶. This investigation into product disassembly reiterates how difficult dismantling products not designed for disassembly can be. The prototype disassembly system is designed around a CRT. A groove is

notched all the way around the edge of the screen, and into this groove, a Ni-Chrome wire is laid. When the wire is connected to a power source, the screen cracks cleanly and completely along the wire line. Although this technique allows internal parts of the CRT to be recovered, the CRT itself still needs to be removed from the product casing. It is also not a generic fixing/ disassembly solution, as desired by *Dowie*⁵⁷. However, if a specific disassembly line were to exist for this one product, the solution would be useful.

2.8.3 Nokia

The current industrial partners for the EU 'Active Disassembly Using Smart Materials' Framework V project (*Sony, Motorola, Nokia*) are understandably publicising their involvement, and using the project as a means for strengthening the companies environmental strategies. This publicity has been in the form of web links on the company's websites, and in promotional videos. *Nokia* however have been active in publishing some of their experimentation at various international conferences.

*Tanskanen*⁵³, an environmental researcher at *Nokia*, details the reasoning behind Active Disassembly research as a need (economically) for automatic separation techniques and a need (environmentally) for a system that allows material recovery. Their candidate product of a mobile telephone, designed using DFA, DfD, and Design for Environment (DfE) techniques, achieved a disassembly time of two seconds, fifty times faster than that of a manually disassembled telephone. See figure 2.14 for details of the *Nokia* telephone.

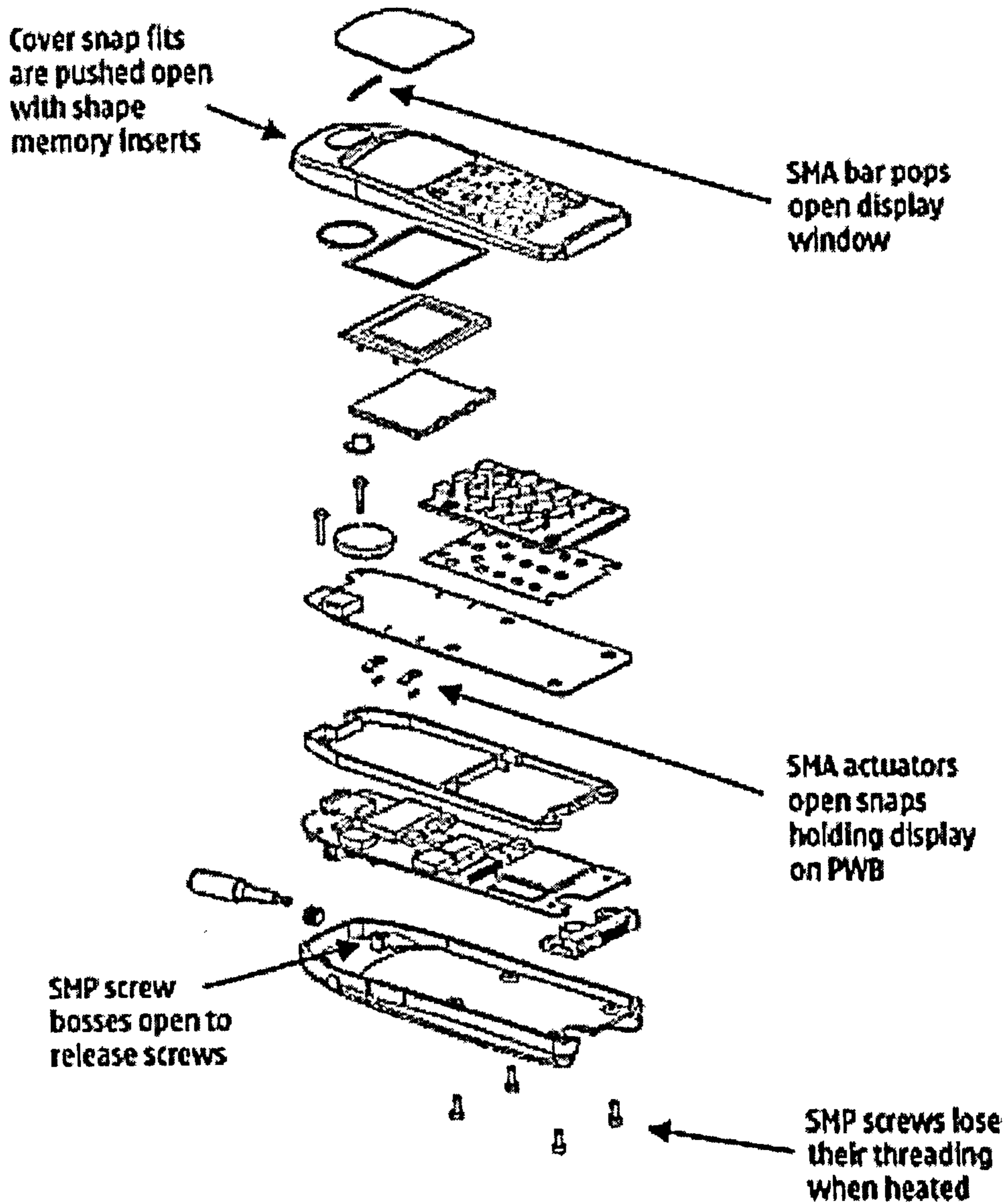

In this Nokia 5510 prototype, smart materials disassemble the phone into sections when heated. Shape Memory Alloy (SMA) actuators curve to open the snap fits holding the cover, display, and display window in place. The screws and screw bosses are made out of a Shape Memory Polymer (SMP), such that no extra parts are required for active disassembly.

Figure 2.14 Promotional Information Sheet Produced by Nokia Detailing Their Research

Nokia also detail that dedicated material recovery facilities (MRF) are also under development. Their design solution was based around a 'pin' on the end of an SMA actuator, 'pegging', and therefore locking, the two halves of the telephone together. Focusing a laser on a "heating stud" triggers the SMA actuator releasing the 'lock'⁵³. The two halves of the telephone then open to allow part reclamation. The issue of further disassembling individual liberated components still remains, although this would not be an issue if the parts were destined for re-use. Further details of this experimentation will be disseminated with the publication of the EU framework Five 'ADSM' project, late 2003.

2.8.4 Sharp

Perhaps inspired by the work of *Nokia*, *Sony* and *Motorola*, *Sharp Corporation* have published their first paper on what could be regarded as active disassembly⁶⁷. This paper details the Japanese equivalent of the WEEE directive (much lower targets than for WEEE), and how SMA actuators can be incorporated inside products at the design stage. The paper is very scant on technical details, and contains no case studies or references.

2.8.5 University of Tokyo

The University of Tokyo have been active in the area of reversible interconnection since 1984, with one particular researcher, *Suga*, having published extensively^{8, 69, 70}. The process for disassembly is based around surface interface phenomena; interface reaction control and interface distortion control. Joint disassembly is achieved by inserting a hydrogen storage alloy (HSA) into the interface of the joint. When the joint is then exposed to hydrogen, the jointing alloy "exfoliates", releasing the joint. Exfoliation only occurs under very particular conditions. For a $MmNi_{4.5}Al_{0.5}$ alloy, heating to 360 degrees Kelvin in a vacuum for five minutes is required (temperature alters the speed of hydrogen absorption.). As this is a very special circumstance, it is very unlikely to happen accidentally.

Although the emphasis of the work in publications since the late 1990's has shifted towards possible environmental applications, initially the research was around the pure development of the chemical technology. *Suga* has been following closely the activities of the ADSM research group at *Brunel*, and has adopted the 'active disassembly' terminology⁷⁰. At this stage, the materials and disassembly systems are too complex for inclusion in consumer products.

2.9 ADDITIONAL MOTIVATION FOR ACTIVE DISASSEMBLY

Together with the desire to meet the targets for the EU ELV directive, the other sole objective for active automotive disassembly, is simply the requirement to separate waste streams in an economic manner for recycling. By providing a means for clean waste streams, the recycling of vehicle waste to a level not achieved before become possible.

There are several research groups already operating in the area of processing of ELV's and ELV associated waste. However, what is needed for these waste schemes to be successful, is a cleanly separated waste stream. ADSM can provide means of achieving the required waste streams and provide a means for these projects to progress more swiftly.

2.9.1 University of Windsor, Canada

Although not regarded as active disassembly as such, due to the fact that there is no stimulus response involved, *Bains*⁷¹ at the University of Windsor, Canada has been approaching vehicle separation from an alternative angle. It has already been acknowledged that Copper separation is a very desirable practice when reclaiming steel. The Canadian approach has been to aid compliance with the forthcoming ELV directive by cryogenically separating non-metallic wiring insulation from the conductor material. The existing methods used for harness recycling typically involve shredding and possibly incineration. Their new method for separation is to embrittle the insulation using liquid

nitrogen. A roller system then strips the insulation from the wire core to leave two separate waste streams clean and free from substrate⁷¹. Although this technique is valid in itself, it lies one stage ahead of active disassembly. This method provides no means for separating the loom from the vehicle.

2.9.2 Waste Energy Research Group (WERG) at Brighton University

Like the work undertaken by *Bains*, the work undertaken by the Waste Energy Research Group (WERG) at Brighton University could also benefit from active disassembly technology. The Research at the *WERG* centres on producing recycled plastic products from post shredder plastics, and also from plastics recovered from shredder residue. Post shredder plastics products such as flower pots, jerry cans and windscreen washer bottles have all been successfully created from post shredder plastics. From a plastics technology perspective, the projects have been very successful, and the only barrier from applying the technology for FMCG packaging is the ruling that there should be no non-virgin plastics on any container surface that may come in to contact with food⁷². Their research also looks at the performance and recyclability of post consumer plastics, but this starts to fall outside the remit of this investigation⁷³. Again, if easier methods for clean part separation can be found, reprocessing the waste material into something useful becomes much easier. Active disassembly would therefore be very much a complimentary technology.

2.10 ECONOMIC AND WHOLE LIFE CYCLE ASPECTS OF ADSM

During the course of this research, additional works have been published supporting the economic case for ADSM integration^{74, 75}.

2.10.1 LCA Results

The key issue with ADSM is ensuring that as a DfE tool, it is not environmentally more impacting than the straight shredding system that it supplements. Standard ISO 14040

LCA techniques were applied to the 'EU Framework 5 ADSM project' candidate products. This LCA analysis was conducted with ADSM products triggered by an external heat source. The outcome of this analysis was in favour of ADSM⁷⁴. However, the LCA technique does not consider economic issues, so these have to be dealt with separately. Obviously, by further reducing the energy consumption in the disposal phase by utilising an assembly's internal energy, the analysis would come out more favourably still. Again, detail can not be divulged with regards to the product details due to the confidentiality with the EU project partners.

2.10.2 Economic Benefits

We can further back up the LCA economic assumptions by looking at an economic analysis of ADSM. Economic implications were considered by *Boks* at Delft University⁷⁵. Disassembly is envisaged in three scenarios:

- Manual disassembly
- Shredding with prior manual disassembly
- Shredding only.

ADSM could wholly replace manual disassembly in scenarios one and two. ADSM could still be implemented as a complementary system to scenario three. It is summarised by *Boks* that in short, "ADSM is to be regarded as a 'competing technology' when compared to manual disassembly . . . and complementary to shredding technologies"⁷⁵.

With regards to the most suitable candidate products for inclusion of ADSM, again, *Boks* has definite ideas. It is summarised that plastics dominated products due to their low material recycling efficiency and high recycling costs are particularly well suited.

However, it is surmised that metals dominated products are not ideal candidates, as their plastics contents are low, and recycling efficiency is high due to magnetic sorting⁷⁵. This is indeed true, but special consideration must be given with regards to the automobile.

Firstly, the achievement of 75% recycling (*by mass*) is still short of the directive target, initially by 10%. The inclusion of supplementary technology must therefore be beneficial (i.e., included in all three possible recycling scenarios stated above). Secondly, although the automobile must be considered on the whole a metals dominated product, the contained sub assemblies are not. As we have already identified, large plastics containing assemblies such as the instrument panel, are good candidates for ADSM themselves, once removed- actively or otherwise.

From a purely economic perspective *Boks* envisages that ADSM inclusion will be at minimal cost, and that the operation of the required plant will also be at a cost not significantly higher than existing systems⁷⁵. Therefore if inclusion of the technology, and operation of the plant carry no significant cost deficits, there only remains the additional *benefit* of the resulting pure sorted waste streams, and any parts that are able to be reclaimed for recycling or reuse. This is not to mention the added benefit of directive compliance- and therefore penalty avoidance.

2.10.3 Better Than the Shredder?

ADSM can not compete with the shredder directly. It must be emphasised that even middling to large sized 4000hp shredders process around 30 tonnes per hour. Therefore, if each vehicle has a rough weight of one tonne, each vehicle would have to be totally dismantled, sorted, and then baled inside two minutes. Even with the best of intentions and an army of manpower, getting a vehicle apart in less than 100th of the time taken to assemble it, is not realistically possible. Conclusions have been drawn from this work to aid the implementation of ADSM into vehicles as a supplementary technology.

Figure 2.15 illustrates separated gold containing fractions from a small electronics products shredder. This clearly shows how good the shredder and accompanying MRF really can be.



Figure 2.15 Recovered Gold Containing Fractions From a Materials Separation (*Post Shredder*) Plant. (Figure Courtesy of Recycling International)

2.11 THE PROPOSED EXPANSION OF ADSM INVESTIGATION

As stated in section 2.8, there has been a tradition of ADSM investigation at *Brunel* since the mid-nineties, centring on aiding the compliance of the forthcoming WEEE legislation⁸. By investigating automatic self-disassembly systems, the need for dedicated robotic or manual disassembly lines becomes redundant^{96, 97, 98}. The decision not to try to further manual disassembly systems was primarily influenced by the 20-minute window when the vehicle is being depolluted. By executing the simultaneous deployment of multiple active devices, many parts can be removed by a single technician. Also, by developing systems of simultaneously releasing fasteners, sub-assemblies that conventionally are very labour intensive and hence time consuming to be removed, may still be recovered inside the 20-minute depollution window. Active disassembly technology has the potential to achieve complete product disassembly, whilst eliminating the associated cost

of additional technicians. Active disassembly is sympathetic to time-related throughput. The associated 'pure' waste streams generated by 'clean' disassembly means scrap can be easily sorted into separate waste streams.

Chapter 3

User Pull

3.1 INTRODUCTION

The European directive 2000/53/EC on End of Life Vehicles is compulsory legislation⁹. It can not be ignored, so vehicle manufactures have no choice but to organise a more structured approach to recycling if they are to meet the directive satisfactorily.

Before looking at how the vehicle recycling system can be improved and optimised, the current system was assessed. From various site visits, an insight was assembled into how the automotive recycling system is working, and how it has had to evolve to meet the European directive.

3.2 THE DISMANTLING SYSTEM

Responsible dismantlers are usually members of regulatory governing bodies. These include the Motor Vehicle Dismantlers Association (MVDA) and the Consortium for Automotive Recycling (CARE). The MVDA ensures that a code of conduct is adhered to by all its members and works with the dismantlers on how to implement the forthcoming directive stages. CARE is a group comprising of 20 major vehicle manufacturers- together with some of the UK's premier dismantling operations, to research and technically

develop ways of reducing landfill from scrap vehicles. CARE forms the link from the dismantler to the manufacturer.

In accordance with the forthcoming ELV directive, dismantlers will now not only sort their vehicles for scrap, but they will have to depollute the vehicles as well. This is to decrease toxic shredder residue. As well as the directive ensuring that vehicles are recycled with as little environmental damage as possible, the directive also aims to eliminate the unlicensed dismantler.

Due to the very low value of scrap steel and the high costs of investment and running an approved '*Vehicle Depollution Station*', scrap cars are worth very little. We can divide ELV's into two categories, (n)ELV's and (p)ELV's. (n)ELV's are the 'natural' end of life vehicles. These are vehicles that have come to the end of their useful life. They are probably MOT failures, high mileage vehicles that don't hold the possibility of the vehicle dismantler gaining any revenue from the sale of spare parts. The dismantler will usually charge a disposal fee to process these vehicles. (p)ELV's are those vehicles that are 'premature' end of life vehicles. These will have reached the end of their life early due to accident, flood damage, fire, or some other unforeseen event. These vehicles are able to be part dismantled or 'broken' for financial revenue from the sale of spare parts. Dismantlers often offer a choice of late model cars for customer 'picking', where the customer removes the spare parts themselves for use on their own vehicles, or a trade counter service where customers are able to purchase spare parts that have been tested and are offered with a warranty. These spares are offered at a premium⁷⁶.

Approved vehicle dismantlers often receive many (n)ELV's from local councils who recover abandoned vehicles. Due to the fact that vehicle disposal will potentially cost the vehicle's last owner money, vehicle abandonment is a problem across Europe. Across Europe some 10 million cars are scrapped annually, representing about 9 million tonnes of

waste, of which steel constitutes some 6.12 million tonnes (68%)⁷⁷. It is this problem that the ELV Directive will address, together with the diversion from landfill for a lot of vehicles, and the prohibition of the use and disposal of toxic materials in cars. Council contracts are issued to local dismantling firms for the removal of dumped vehicles. The council are usually billed in blocks for vehicle removal services. In return they see a slightly preferential billing rate of around £25 per vehicle (instead of usually £35-50 depending on the vehicle). However, according to Chris Smith from the Glass's Guide, local dismantlers are still charging the tax payer up to £37.5 million each year¹².

3.2.1 'Natural' End of Life Vehicles- (n)ELVs

The treatment of (n)ELVs is very thorough. The vehicle arrives at the vehicle depollution station either on a tow truck or it is driven there by the last owner. The battery is removed and tested, and either put aside for recycling or for reuse, depending on its condition. The wheels are then removed. The tyres are removed from the wheels to be shredded and reprocessed. Steel wheels have no real value and are put aside for steel scrap. Roadworthy alloy wheels are put aside to be sold. Cracked or dented alloy wheels are sold for scrap, the quality of the casting alloy meaning these have a scrap value of around £5.

The vehicle is then lifted by forklift into a depollution station where the vehicle has all of its fluids removed. The fluids include: engine oil, gearbox oil, differential fluid, coolant, fuel, washer fluid and any hydraulic fluid such as brake fluid and power steering fluid. Shock absorber fluid can also be removed by drilling the damper although this is time consuming. These fluids are retained in pressure resistant containers for collection by a specialist recycling contractor. Whilst the vehicle is suspended on the platform, the catalyst is also cut from the exhaust system. The catalysts are then sent to a specialist facility where the 'cats' are 'de-canned' and the precious metals (platinum and palladium) are recovered. This also provides a small amount of revenue for the otherwise costly

process of treating (n)ELVs. However, there are still plenty of (n)ELVs that are not equipped with catalysts. This whole process takes around twenty minutes. Even though it may be possible for the dismantling technician to complete the work much quicker than this, time has to be allowed for the viscous cold oils to completely drain.

Once the directive is in place, it will be at this stage that a 'Certificate of Destruction' (COD) will be issued. This is essentially a recording of the vehicle with the DVLA as an ELV, and that the vehicle has been destroyed. A certificate of destruction is then be issued to the last owner. Currently the only system in place involves filling out the bottom section of the vehicles V5, and returning it to the DVLA in Swansea. This then registers that the vehicle has been scrapped. However, abandoned ELVs typically have no paperwork, so at best, all the dismantler can do is to log the VIN number, and check that there is no outstanding finance on the vehicle before it is destroyed.

Charles Trent Ltd in Poole, is currently trying out a pilot system where the vehicle dismantler is linked directly to the DVLA computers in Swansea⁷⁶. The vehicle engine and chassis numbers are entered into a computer, along with the vehicles colour, and then the DVLA will authorise the destruction of the vehicle- if there are no problems, such as the vehicle being registered as stolen. This way the situation of an un-roadworthy vehicle being 'in the system' for two weeks is avoided and the vehicle is accounted for at all times. It will be on the back of this system that the issuing of an actual COD will be based. Vehicles without paperwork can therefore also be accounted for. It should be pointed out that there is a voluntary infrastructure for the notification of the destruction of a vehicle via the DVLA V860 form (Appendix C). However, currently the only subscribers to this system in any large numbers are the insurance industry. This is because it is in their interests to register their own written off and destroyed vehicles to prevent them from being repaired and put back on the road.

The vehicle is then taken by forklift where it is prepared for the crusher- or 'baler' by a crane with a 4-tine grab. The crane operators are highly skilled and can further disassemble the vehicle if economically viable for material recovery. The crane operator will always break the screen of the car *into* the vehicle to avoid hazardous glass shards flying out from the car as it is manipulated. In less than 5 minutes, both bumpers and the dashboard can be removed by the grab and put aside for plastics recycling. The airbox again can quickly be removed for its plastic content. The carburettor is also sometimes removed as this may be made from a valuable die casting alloy. The engine is then removed by the grab and stockpiled according to its material composition; an alloy engine, an iron engine, or a mixture of the two. Rear axles are also occasionally removed (on rear wheel drive vehicles) as this material can be put aside with the rest of the cast iron. The remaining shell is then put into the baler and 'cubed'. This material stream either goes off to a specialist material recyclers (Aluminium, cast iron- materials of a reasonably pure nature), or to the shredder (Light iron, car bodies containing seats and other fluff).

As the ELV legislation is not yet fully in place, plastic is not usually recovered, as there is no economic driver to do so. However, the crane operators prove that removing large plastic parts quickly and effectively with a crane grab is not a problem. Plastic parts are put aside for manual sorting, as certain plastic types must not be mixed. From a design point of view, it would be enormously beneficial at the point of dismantling, if the plastic parts could be removed cleanly with no retained metal fixing posts or clips to pollute the plastic that goes for granulation. In 2006, when the 85% target has to be met, plastics will undoubtedly be one of the materials targeted for specific removal. Modern cars contain more polymer materials than any previous generations of motor vehicle (*see figure 3.1*).

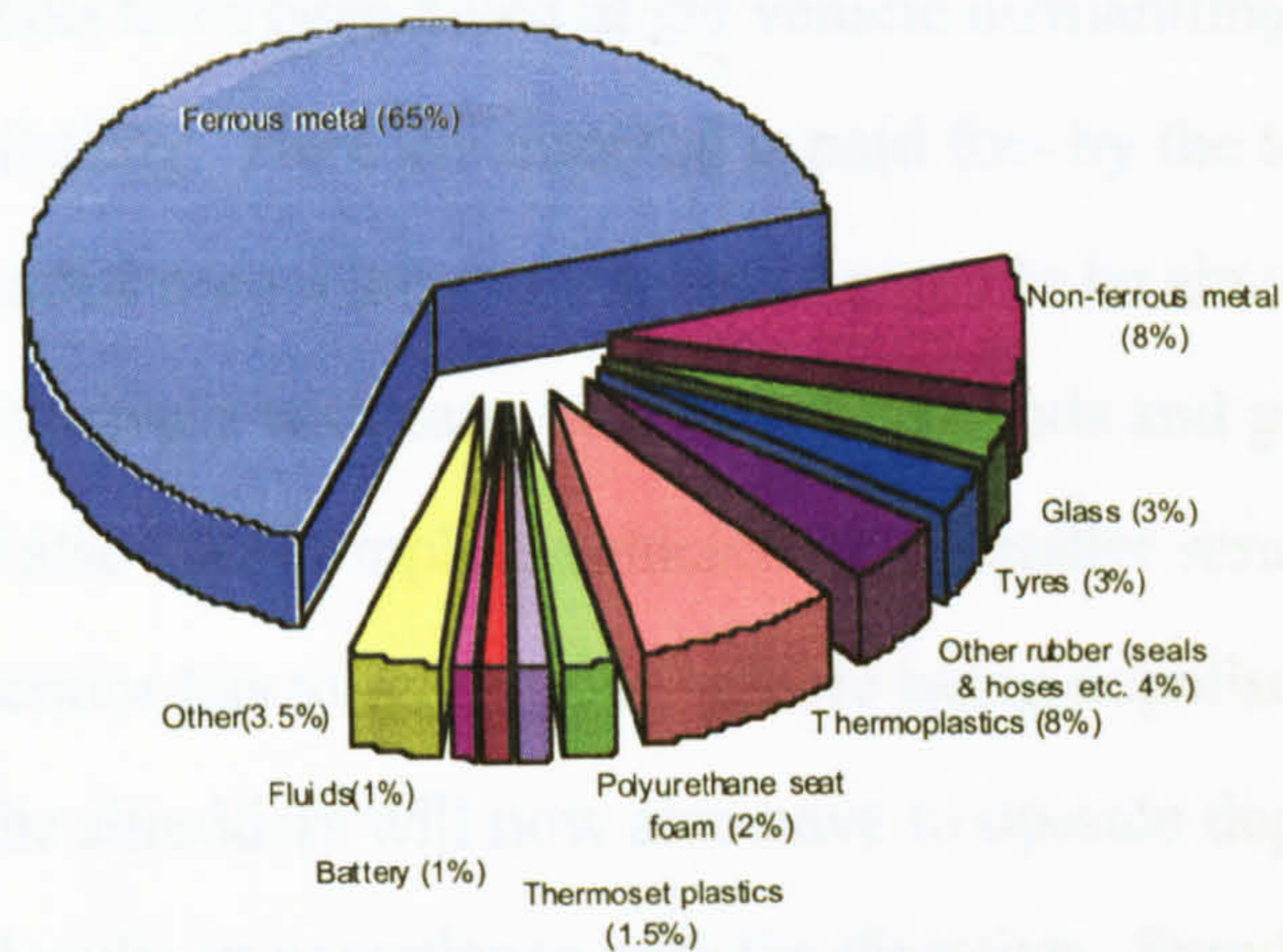

Figure 3.1 Material Composition of a Typical 1990 s Vehicle *By Mass* (Source: ACORD)

3.2.2 'Premature' End of Life Vehicles- (p)ELVs

(P)ELV treatment is tackled somewhat differently. As (p)ELVs are typically up to seven years old, they are a more true representation as to what is currently driving around on our roads. Therefore, there is a higher demand for high quality used spares from these vehicles. The majority source of these vehicles come from insurance write-offs, either due to accident, fire, flood or attempted theft damage. These vehicles are also depolluted in keeping with the legislation, but they are then further dismantled to recover individual parts. This is either done by a dismantling technician or by customers if the vehicle is retained for customer 'picking' in a yard. The fact that these vehicle parts become the 'stock' that the dismantler keeps, means that they are carefully disassembled from the outset so that the vehicle can provide a maximum return. There should not be a problem with these vehicles complying with the directive, although disassembly time of some of these vehicle parts could be improved. As it is the parts from these (p) ELVs that are used to keep private vehicles on our roads, it is important that the quality of the removed parts is kept high. This is also a good example of the Eco-principle of part re-use being exercised.

3.3 SHREDDERS

Once the scrap vehicle hulks have been baled at the vehicle dismantling yard, they are sent off to a metal shredding facility. Here the material is paid for- by the tonne- by the shredder operator, and loaded onto a large stockpile of scrap to be shredded. The shredder will not deal exclusively with cars, but also white goods and general industrial scrap. The shredder will also take complete vehicles from smaller scrap yards or from the public. The shredder operator has to rely on the vehicle being depolluted by the dismantler. However, the shredders will now also have to operate depollution stations in order to process ELV's cleanly, in accordance with the directive. Shredders, like licensed vehicle dismantlers will now have to invest heavily in equipment to allow them to continue to operate in accordance with the directive. Vehicles arriving directly from the public must be treated in a vehicle depollution station prior to shredding- just as they would be if they arrived from a dismantler. This way the shredder is kept operating as cleanly as possible.

The scrap is fed onto a huge conveyor system where it is shredded into small chunks by a rotary hammer at the bottom of a hopper. The shredded fractions are then sorted on conveyors with magnets and eddy-current separators into ferrous metal, non-ferrous metal, light fractions or 'fluff' and aggregate containing glass and concrete. The ferrous material approximately breaks even as far as the processing costs against handling costs are concerned. Fluff and aggregate both carry a negative value, that is made up for by the non-ferrous metal revenue. The non-ferrous material is further sorted in floatation tanks, and then manually into different metals types. However, as the labour cost for this is high, the material is exported to the Far East for sorting. Speaking to operators such as EMR, who have their own shipping line, and therefore a complete infrastructure, this is economically viable. Currently, shipping costs to the Far East are running at approximately £7.00 per tonne.

3.4 TIME TO IMPLEMENTATION

With the development of any new system, there is a time frame for 'system adoption' to take place. As well as the few development years needed to refine a new embedded disassembly technology, once established, it takes in the region of 15 years for the implemented technology to reach '*the scrap yard*.' Any delay in dealing with airbag systems is potentially dangerous as it will not be long before airbag equipped cars of the nineties start to find their way to vehicle dismantlers in significant numbers. These will need to be dealt with promptly, and with technology that can be implemented immediately. As with the rest of the vehicle, a dismantling system to aid compliance with the ELV directive has to be adopted as soon as possible. In the meantime, airbag devices MUST be triggered at EoL. Manufacturers provide guidelines on how to complete this task.

It will only be once the infrastructure for ELV depollution, and material separation is in place, that an overall cost for dismantling each vehicle can be calculated. Once this figure is known then it will be easier to assess *if* adoption of ADSM techniques will be economically beneficial in terms of time saved versus individual vehicle hardware investment.

3.5 ELV- AN END USER SURVEY

ADSM technology has already been established as a possible method for dealing with EoL products, and an assessment has been carried out into the current infrastructure for dealing with ELVs as part of this work. Speaking to those involved in dealing with ELVs a small 'end user' survey was conducted with different sectors of the automotive industry. These people were spoken to, to see how *they* thought ADSM could benefit them. The names of the individuals spoken to are not revealed as their 'inside' opinion is not necessarily the same as the companies official line. These people were:

-
- Technicians at Car Spares of West Drayton, a large unaffiliated (licensed) vehicle dismantlers, who have invested in their site to keep it compliant, but are not investing further until the directive is implemented. *Reactive rather than pro-active*
 - European Metal Recycling (EMR). EMR are a shredder operator, the largest operation in the UK, operating many sites across Europe. They are operating depollution stations at their shredder sites to deal with ELVs brought to their sites. They are reliant on baled vehicles being depolluted prior to being transported to the shredder
 - Charles Trent Ltd. Vehicle dismantlers and vehicle depollution station operator. Piloting a computerised 'Certificate of Destruction' (COD) system with the DVLA. Partnered research with the WERG, Brighton University. *Very pro-active*
 - Visteon UK Ltd, tier 1 automotive parts supplier of interior systems and other automotive parts
 - Ford, Dunton Green, the British R and D centre for the second largest automotive manufacturer in the world
 - Designers and environmental managers for Fiat, Honda and Nissan.

These people were selected as they are either involved with vehicle design to comply with the ELV directive (manufacturers), or are involved with actually implementing the directive (dismantlers/ shredders). It is important that any solutions developed are compatible with both parties from a design integration perspective (manufacturing phase), and from an operational perspective (recycling/ reuse phase).

Notes were taken from the interviews and a 'Thematic Analysis' was undertaken to establish the key points from each interview⁹⁹. These then helped to form the criteria for investigation detailed at the end of this chapter.

Local authorities were also consulted ^{1,2} together with a representative from the *DTI*. Both returned very positive feedback for the direction of the investigations. Local authorities are presently responsible for footing the cost of ELV abandonment. Any efficiency added to the ELV infrastructure, which could lead to scrap vehicles again having a revenue- and hence *decrease* abandonment would alleviate loads on local authorities “tremendously” ¹.

The *DTI* are responsible for implementing the ELV directive and establishing the economic system to ensure that no costs are passed on to the consumer by 2007 ¹³. Any proposed modifications to the ELV infrastructure that leads to overall cost reductions and increased shredder revenue must be embraced.

All contact with the various manufacturers and organisations detailed above were on an informal basis with the exception of Ford. Ford were also consulted on a formal basis, with both their UK materials engineers and German production engineers present. As well as being positive about the proposed work, they were also interested in releasable fastening systems for possible product ‘re-working’ on the production line. Although this would be a valid and viable use of releasable fasteners, a production analysis is outside the scope of this study.

There were similar thoughts echoed by all the vehicle operations communicated with.

- Firstly, they were all keen on removing the catalyst from the vehicle, as this is a very high value part- and there is very little labour time needed to remove it. At the depollution station, the ‘cat’ is usually simply cut off with hydraulic or air powered shears. The ‘cat’ recycling infrastructure is already established to recycle the platinum and palladium contained within the catalyst
- The instrument panel (IP), along with the bumpers were identified as being the largest masses of single virgin polymer type on the vehicle. The instrument binnacle itself

contains optical grade PC together with various electronic components that have potential revenue at EoL, especially if the IP is being removed already. Removal of these parts would aid directive compliance, and there is second use for most automotive plastics. Nearly 60% of waste automotive plastic is either PP or ABS based (*see figure 3.2*), and both these streams of plastic waste can be baled and sold for recycling.

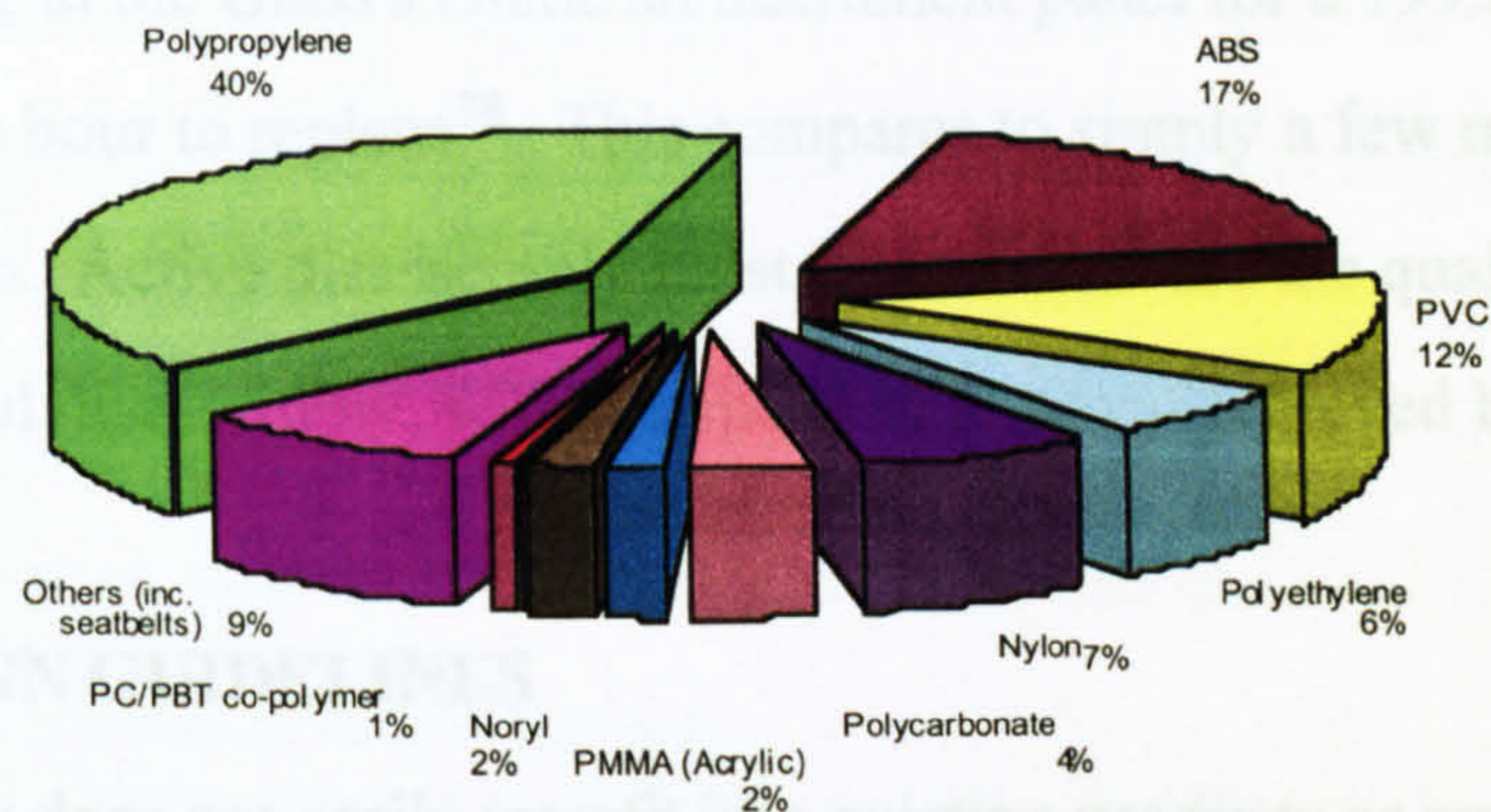

Figure 3.2 Typical Polymer Composition of a 1998 Vehicle *By Mass* (Source: ACORD)

- The vehicle glazing constitutes the largest non-metallic material fraction in the vehicle, and removing this will aid directive compliance (*Figure 3.1*)
- Air bags pose a serious threat to the safety of employees, and a strategy for dealing with these needs to be implemented.

In speaking with the automotive manufacturers, the impression given off the record is that it is not in the manufacturers interests to make a serious investment into dismantling technology. The directive applies to vehicles that are currently in production, so it will therefore be up to the dismantler to ensure that the targets are met. As it seems (although as yet undecided) that the cost for directive implementation will be based upon market share, each manufacturer has no wish to make their cars particularly easy to deal with

compared to another. However the directive does state, dismantling should be at no cost to the end user from 2006⁹. The manufactures did acknowledge that from the point of view of servicing, time saving ADSM technology could be of use to their dealers. Perhaps most importantly, the *technology* for ADSM seemed to be of no consequence to the dismantlers. All that matters is any dismantling techniques introduced must be quicker than a technician with an air powered tool, or even the crane operator. Any tools needed to trigger devices must be cheap to both buy and run, and also very robust. For example, according to the Glass's Guide an instrument panel for a 1995 Ford Escort should take half an hour to replace⁷⁸. This compares to simply a few minutes if removed by a hydraulic grab. Active disassembly must aim to combine the quality of part removal achieved by manual disassembly, with the speed of removal achieved by a crane operator.

3.6 ADSM DESIGN GUIDELINES

ADSM technology does not easily retrofit into existing products or assemblies, both from a design perspective (fastener incorporation) and from a thermal perspective (achieving adequate thermal penetration to trigger the device). To further analyse the results of Section 2.6 '*Methods for Triggering Active Disassembly*', together with section 2.7.3, the '*DFD Guidelines*' by Dowie⁵⁴, we can compile a list of 'ADSM Design Guidelines'. These guidelines are similar, but nonetheless supersede the guidelines published by *Billett et al.* in their initial EPSRC report in 2000²³.

For most efficient active disassembly, disassembly needs to be achieved consuming as little energy as possible, and with as little energy *wasted* as possible.

Heating-

- SMPs are currently suitable for applications with ambient temperatures ranging 25-60⁰c

-
- SMAs are currently suitable for applications with ambient temperatures ranging -120-+120⁰c
 - A thermal flow CFD model such as ANSYS/ FLOTRAN should be undertaken on the host part₁
 - For products heated by hot air/ IR heaters, the devices should be as near as possible to the surface of the product
 - Where it is not possible to site the device near the surface, a free air passage from the surface to a plenum chamber surrounding the device should be incorporated. The plenum chamber must surround the device to allow complete heating, not just from one side
 - Enclosed air chambers in the product casing can be used for insulation where required
 - Devices triggered by laser or hot probe may need a 'thermal rail' to conduct the heat to the device if it is not near the surface
 - For inductive triggering, consideration must also be given to other metallics within the product. A CFD analysis is again recommended.

Product Architecture-

- Tolerance control must be exercised on active systems to ensure complete disassembly as expected
- The product casing should illustrate any requirements for product orientation during disassembly
- LCD screens and possible leaching hazards must avoid being designed for disassembly by immersion. Elevated temperatures may also cause LCD destruction.
- Clean passage for separation must be allowed. DFA considerations should ensure this, as will a DfD analysis.

Local Architecture-

- The device must be permitted free space to complete the dimensional change associated with its transformation
- Any sliding surfaces should be free from pressure from any other planes
- The active device must be able to provide sufficient force to overcome the retention forces and inherent strength of the assembled product (and then break it apart).

Alternatively the active device or system must be able to provide sufficient retention strength to hold an assembly together when disassembly is envisaged by property loss (i.e. SMP rivet relaxation).

Additional Considerations-

- Consideration must be given to which materials/ components have resale value (making disassembly profitable)
- Consideration must be given to which components must be removed to comply with legislation
- The degree of separation versus possible product destruction must be analysed₂
- Consider competition from other market sectors, i.e. achieving higher output fractions than shredding
- Disassembly is usually only required to separate waste streams- components of the same material may not require separation
- Minimising the type of active fastener, only utilising different triggering temperature devices where hierarchical separation is required
- Keep to a single triggering method to minimise disassembly plant investment
- Disassembly points should be clearly identified₃
- Replace snaps that require tools to open with active snaps
- Incorporate non-ferrous metallic devices in to non metallic components, and polymer devices into polymer components
- Minimise the number of parts to keep assemblies modular

- Standardise active fasteners, and fastener patterns to be compatible with all the assembly modules
- Locate common materials in one area inside the product
- Locate all un-recyclable materials together in the product
- Break points should be made clear
- Employ DFA and DfD principles

Footnotes:

- ₁The deeper an active element is concealed within a product, the higher the surface temperature of the product can be before the SME occurs. Depending on the thermal conductivity of the casing material, thermal conduction means the inner temperature of an assembly does not reach the temperature of the outer surface
- ₂The possibility to facilitate complete non-destructive separation is realistic, although it can be envisaged that this will take longer, and will require a more methodical approach for disassembly. Faster separation could be achieved by destructive separation
- ₃ As the active disassembly technology evolves, standards may have to be established for the identification of the required triggering mechanism, and at what temperature. Alternatively, the disassembly plant may have to evolve methods of triggering all generic fastener types

3.7 SCOPE FOR INVESTIGATION

There are opportunities that arise when taking a critical look at the dismantling system, as illustrated here by communicating directly with those who deal with ELVs. Also, when looking in detail at precise fractions- such as copper (as illustrated in the literature review), we can see again there are opportunities for ADSM technology to be implemented.

Potential areas to investigate ADSM technology have been summarised by table 3.1.

Areas for possible ADSM Implementation	Reasons For	Possible Barriers
Glass removal	Largest non-metallic single material fraction	Large volumes of waste glass could be created. Can the current glass-recycling infrastructure deal with waste ELV glass, or will alternative uses need to be found?
Wiring Removal	Identified by <i>Henstock</i> as not economically viable to completely recover. Causes problems when re-introduced into the steel mix when the vehicle is shredded and reprocessed	Hard to remove fractions lie under the IP and in other hard to remove areas. Other assemblies need removal before access is possible
Instrument panel removal	Largest polymer component along with the bumpers. Large mass recovery possible. Also contains the instrument cluster- which is valuable and contains a wide mix of many materials, and some electronics This electronic content may also have possible WEEE implications	Very time consuming to remove for re-use. For recovery it can be removed with a grab, but no sub-assemblies are recovered or remain undamaged. Steering wheel obstructs removal
Steering Wheel Removal	Potentially hazardous component containing the air bag. The steering wheel airbag can end up in a variety of waste streams so careful recovery is beneficial	Safety critical application, 100% reliability must be ensured.
Instrument Panel Disassembly	Valuable materials in the form of optical grade PC along with electronic components such as stepper motors. Further disassembly for recycling or reuse essential	Not easy to remove without IP removal. Lots of hard wiring.

Table 3.1: Possible Areas for the Implementation of ADSM Technology

A series of case studies of these possible implementation areas were conducted to further investigate the potential of helping ELV directive compliance by the incorporation of ADSM technology. The case studies are detailed in Chapter 4, along with potential ‘spin off’ areas of research that warranted investigation.

Chapter 4

How ADSM Could Be Used To Aid ELV Directive Compliance

- Case Studies of Active Fastening Solutions

Automotive Applications

Successful demonstrators have been produced that allow the disassembly of various automotive parts, using active fixture solutions. These have been presented in the form of four individual case studies.

4.1 CASE STUDY 1.

Glass Removal Solutions

Introduction

Due to the fact that vehicle glazing contributes roughly 3% of a vehicles overall mass (*Figure 3.1*), incorporating active disassembly techniques into the vehicle glazing could significantly contribute towards the 'additional' 10% of mass that needs to be reclaimed in compliance with the ELV directive.

Releasable door window retainers have been constructed using both SMA (*Figure 4.2*) and SMP (*Figure 4.3*) solutions. In a conventional door glazing assembly, a crimped steel channel retains the glass (see fig 4.1). This channel squeezes a soft rubber 'slip' onto the

glass so that it can not be pulled out. The steel channel is then bolted to the window lifting mechanism. To incorporate active disassembly into the door glass area, the crimped channel must be redesigned without compromising the existing vehicle specification

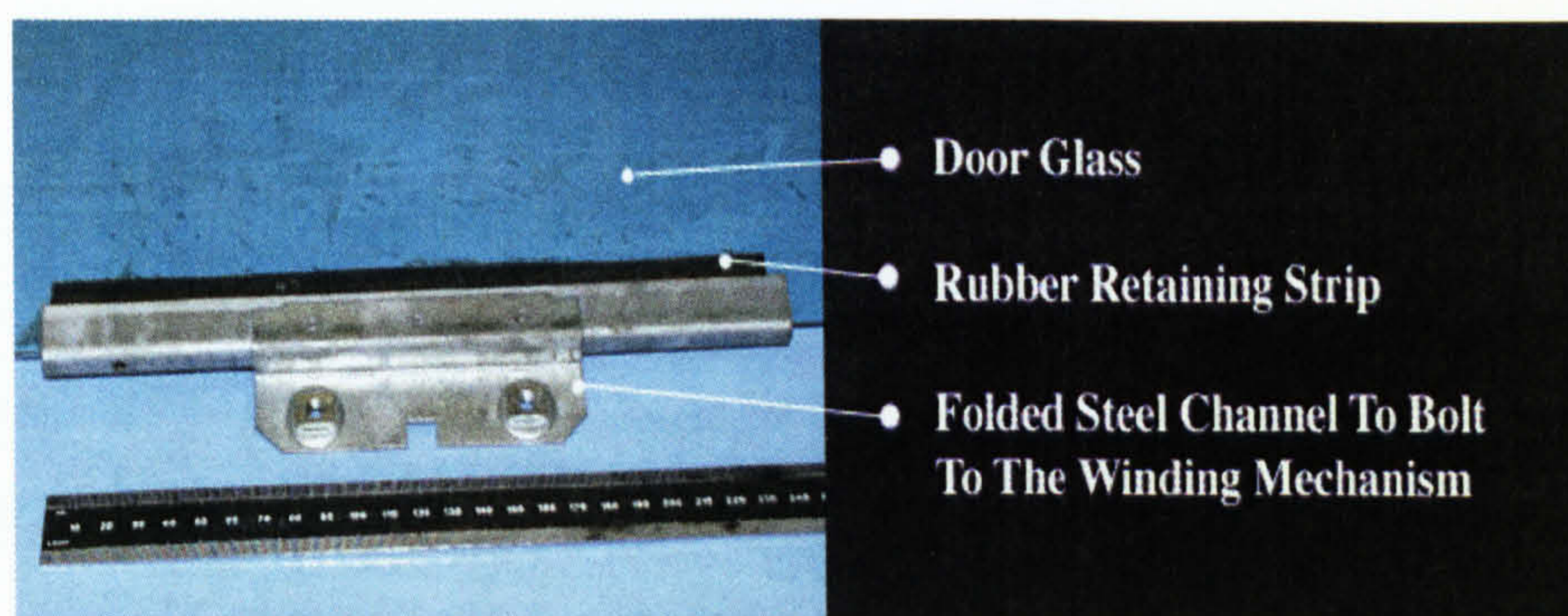

Figure 4.1 Conventional Arrangement for Door Window Glass Retention

4.1.1 Experimental Method

To create a SMA solution, a conventional door glass-retaining channel was used, although it was modified by the addition of some slots to accept the SMA clips. The channel accepted the usual rubber slip that grips the glass. The clips squeezed the slip onto the glass providing retention (Figure 4.2).

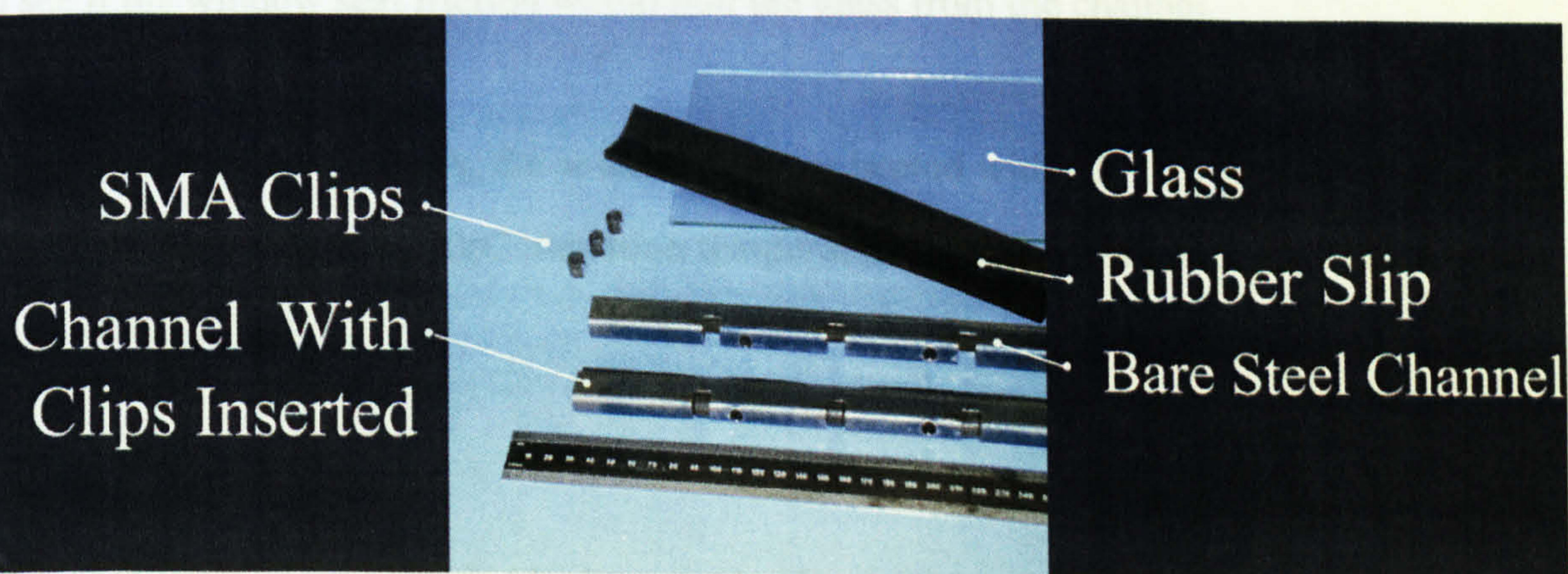

Figure 4.2. SMA Clips Grip the Rubber and Glass Through A Modified Steel Channel

To create a SMP solution, the usual rubber slip is replaced with a SMP slip. As the slip sits within the assembly below its usual transition temperature, the assembly has integrity, and the folded metal channel grips the SMP slip and the glass tightly (Figure 4.3).

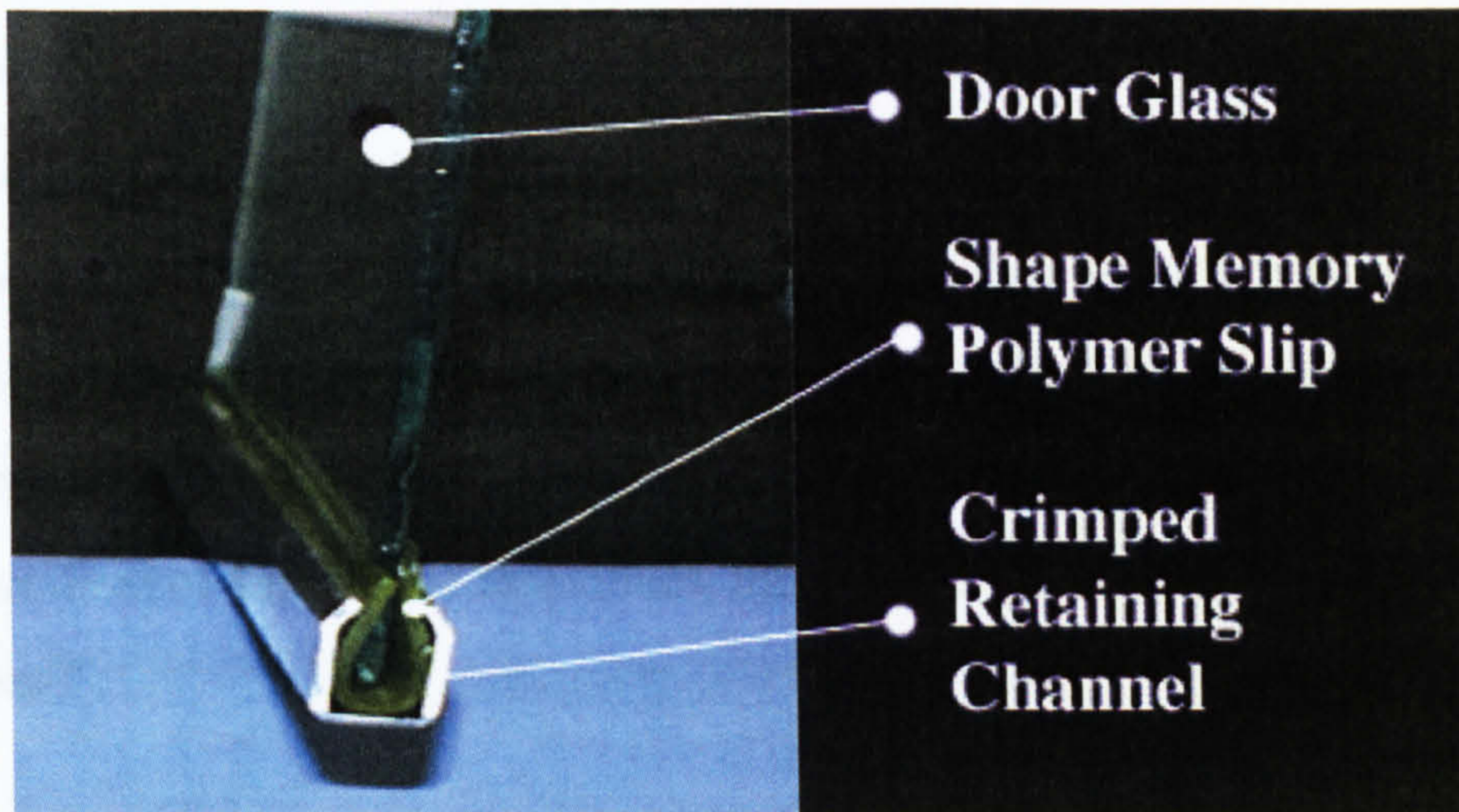

Figure 4.3. An SMP Slip Replaces the Conventional Rubber Slip in a Door Glass Assembly

The assemblies were pulled with 40 Newtons of force to check that the glass was securely retained. The assemblies were then built into a car door and wound up and down. This was to see if the window seal friction would pull the glass from the channel.

To disassemble the channels, the assemblies were heated with a hot air gun. The SMA clips were heated above their 120°C transition temperature, and the SMP slip was heated above its T_g of 60°C.

4.1.2 Results.

The glass retained with the SMA clips was held very securely, and remained tight when the window was wound. Once the SMA clips were heated above their transition temperature,

the clips unrolled evenly and allowed the glass to be cleanly pulled free for recycling. This solution disassembled successfully in lab trials.

The SMP solution was not so successful. Although the glass appeared secure when pulled by hand, the seal friction on the window when it was wound was enough to pull the glass from its channel. The 'releasing' hypothesis was tested in the lab outside of the car door. Once the assembly was heated above the SMP's T_g , the SMP became very soft and spread under the pressure of the crimped channel, allowing the glass to be pulled free. Although the releasing principle of the SMP spreading under a clamping pressure was a success, within the context of automotive assemblies, the SMP solution requires more development⁷⁹.

4.1.3 Conclusions

Although the SMA, and to a lesser extent the SMP, solutions were successful, the heating arrangement was not satisfactory. In an assembled automobile, in order to heat the channels with hot air, the inner door skins would have to be removed. Removing the required door parts would be a time consuming operation. Instead, a hot probe solution would be a simpler heating arrangement. In this scenario, a hot probe could be inserted inside the narrow closing edge of the door in order to make contact with the crimped channel. The hot probe concept is piloted in case study two, section 4.2.

The shape memory polymer solution is not secure enough for use in a vehicle. However, SMP is a PU based material, and the SMP samples used for the experiment were fairly hard in their glassy state (typically Shore D/ 75)⁵. It is possible to formulate PU's with hardness and surface frictions to replicate all but the softest rubber (PU down to Shore A/20 where rubbers can be formulated down to Shore A/10)⁸⁰. With further development, SMP should be able to replicate the Shore A/65 used in the existing rubber slip in the steel channel. Also, SMP is only currently *commercially* available with a maximum T_g of around 70°C.

This is again a long way from the 105°C that a company such as Ford stipulates. Mitsubishi Heavy Industries claim to have developed 120°C SMP samples in the lab, although these are not available.

It may be possible to use an alternative engineering polymer with a higher T_g (such as PC, $T_g \approx 125^\circ\text{C}$)⁸¹ to retain vehicle glazing. However, PC exhibits a less sharp drop in modulus, and release will invariably be slower, and more energy will be consumed through longer heating times. Also, creep can be a problem with engineering polymers under load.

Polymer molecules move to accommodate applied stress and this could cause a loosening of the joint over long periods⁸². However, research is underway by *Hussein et al* on using the shape recovery of engineering polymers for active disassembly, and creep in thermoplastics forms a significant part of this research⁸³.

SMAAs could be used for automotive glass retention. Currently their cost is the main prohibiting factor, as the material itself is expensive and so is its processing and fabrication. The SMA clips would be worth more than the scrap value of the glass they liberate. In this instance, with a T_x of 120°C, they meet the Ford specification for the part⁸⁴.

There is glass within a car that is not retained by a folded steel channel- such as the windscreen, and non-articulated quarterlight windows. Research is underway at Brunel University in utilising releasable adhesive solutions to allow this glazing to be actively removed from the vehicle. *Some of these findings will be published when the outcome of the EU Framework V research programme 'Active Disassembly Using Smart Materials' becomes available in the public domain. This work is currently bound by the University's confidentiality agreement with the industrial partners of the project.*

4.2 CASE STUDY 2.

Active Disassembly in Safety Critical Applications

Introduction

Smart materials have been used in safety critical applications for many years, from disassembling bolt systems holding together the Clementine spacecraft, to hydraulic couplings in fighter jets⁴⁶. SMA materials have the integrity to be used in critical applications.

The life cycle of an air bag encompasses a wider variety of potential sustainability issues than many other parts of the vehicle. Whilst the primary function of an airbag is to preserve life, the fact that it contains a pyrotechnic charge also means that it is also potentially extremely dangerous.

EMR experimented with ELV airbags at their Willesden shredder in 2001. Upon introducing a batch of airbags into the shredder, it was found that only 50% detonated. More alarmingly, due to the die-cast alloy steering wheel hub and the steel steering column, the airbags were divided with 50% ending in the ferrous waste stream, and 50% ending in the non-ferrous waste stream. Non-ferrous waste is still generally hand sorted, so an unacceptable situation arises where live detonators can come into contact with the staff at the materials recovery facility. By creating a safe steering wheel removal system, operator safety can be ensured.

This prototype system piloted the proposed 'hot probe' disassembly method, whereby a bespoke thermal probe positively engages with an SMA collar, and heats it so that it releases, minimising wasted energy.

4.2.1 Experimental Method

Steering wheels (in road vehicles) are usually retained by a bolt passing through the wheel hub into the end of the steering column. There is usually a washer below the bolt, or the washer is built into the bolt-head in the form of a flange. This wheel/airbag assembly is illustrated mounted on the column in figure 4.4

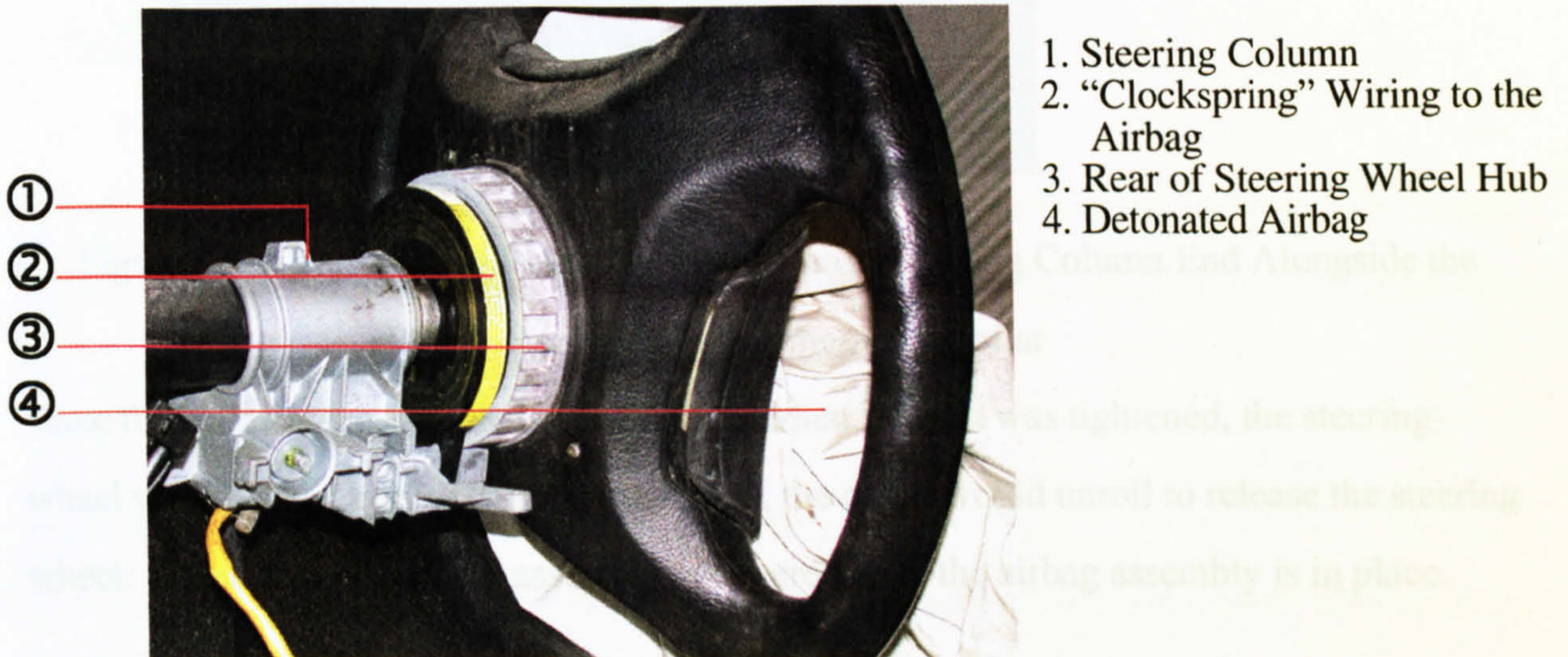
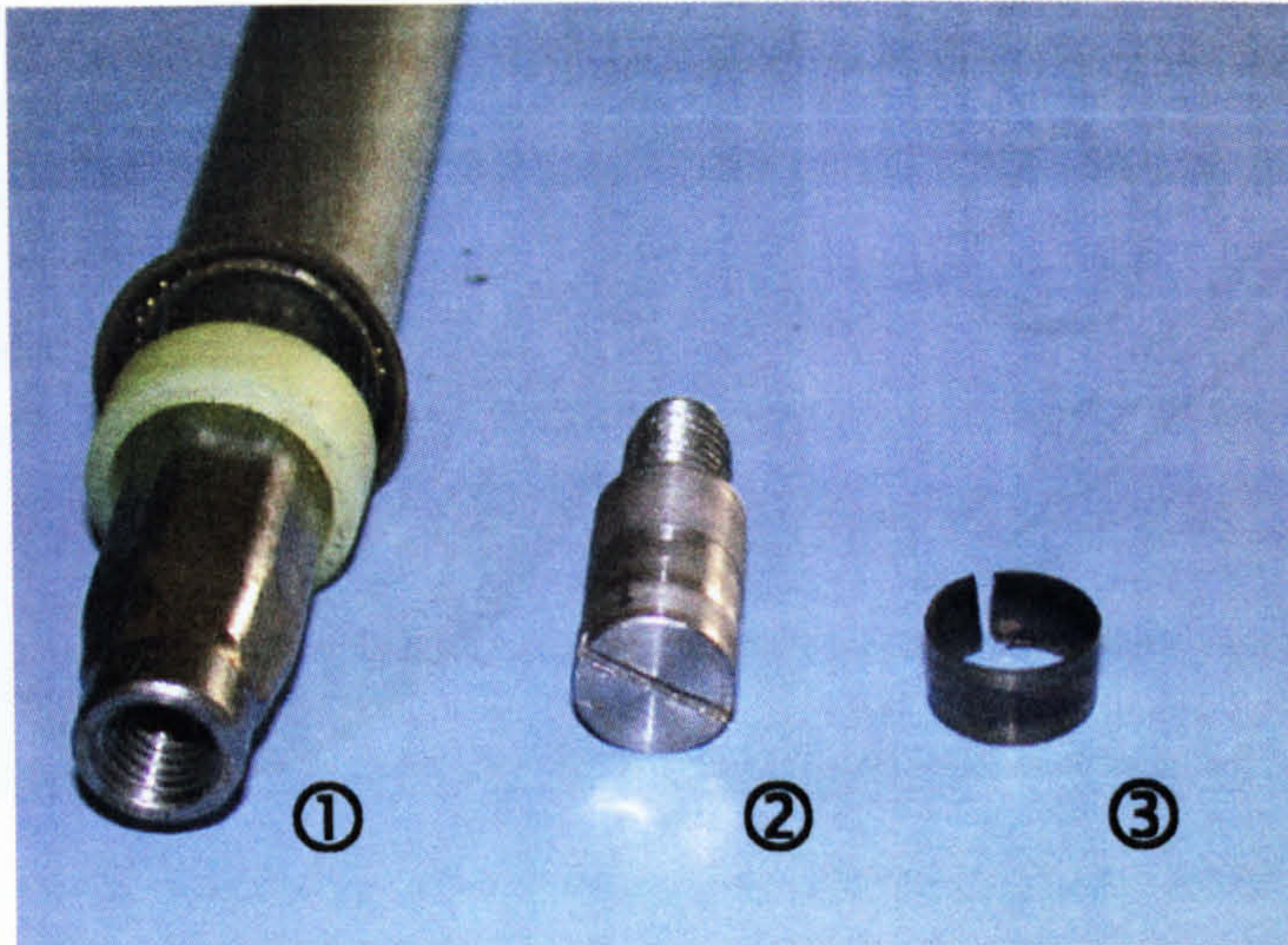

Figure 4.4 Steering Wheel Mounted on the Steering Column

To create a releasable bolt fixture, a special bolt was fabricated. This bolt was simply a short piece of plain bar that was threaded at one end. On the other end a slot was cut so that the bolt could be tightened. The bolt was of a small enough diameter that the steering wheel hub was able to pass straight over the bolt. In order to provide retention, a groove was cut in the bolt shank to accept a fabricated SMA collar. This collar has its major axis in line with the steering column so that it was very stiff (see figure 4.5)



1. Bare End of Steering Column
2. Special Bolt
3. SMA Collar or "Circlip"

Figure 4.5 Wheel/ Airbag Retention Components. Steering Column End Alongside the Special Bolt and the SMA Collar

Once the collar was assembled over the bolt, when the bolt was tightened, the steering wheel was held securely. By heating the bolt, the collar would unroll to release the steering wheel. The whole of the bolt assembly is covered once the airbag assembly is in place.

Heating was achieved by inserting a hot probe into a hole in the side of the steering wheel hub (*Figure 4.6i*). The hot probe made contact with the clip and heated it directly (*figure 4.6ii*).

4.2.3 Conclusions

The special bolt assembly was heated successfully and a shape change occurred. The fastest result (~5 sec.) was achieved when the clip rotated around the bolt, allowing the entire clip to come into direct contact with the probe.

The hot probe could be improved by giving it a toothed profile that would interlock with a tooth profile pressed into the clip (*Figure 4.6ii*). The clip would then be rotated by the

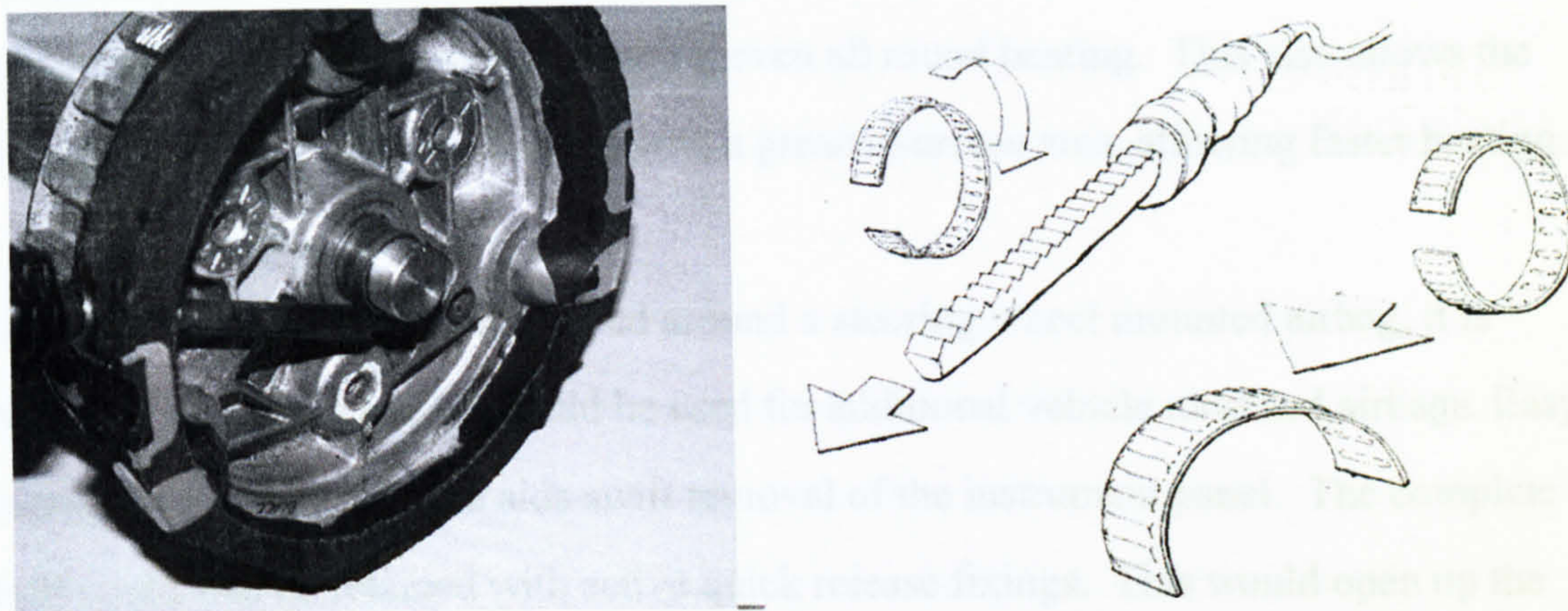

Figures 4.6i and 4.6ii. Illustrating the Hot Probe Engaging with the Releasable Bolt Fixture on a Cut Away Steering Wheel Hub⁽ⁱ⁾, And a More Detailed Illustration of the Probe/Collar Interface⁽ⁱⁱ⁾.

4.2.2 Results

The hot probe engaged with the clip causing it to undergo its SME and unroll. The steering wheel could then be pulled from the shaft. Heating took between 5 and 10 seconds.

However, the clip did not always fall clear of the retaining bolt, so the wheel occasionally had to be shaken to allow the clip to fall clear. Engagement of the probe with the clip could be problematic, as in the enclosed wheel centre there is no visual access. The probe must therefore be engaged by feel.

4.2.3 Conclusions

The special bolt assembly was heated successfully and a shape change occurred. The fastest result (≈ 5 sec.) was achieved when the clip rotated around the bolt, allowing the entire clip to come into direct contact with the probe.

The hot probe could be improved by giving it a toothed profile that would interlock with a tooth profile pressed into the clip (*Figure 4.6ii*). The clip would then be rotated by the

action of the clip being inserted, ensuring even all round heating. This also allows the inserted probe to mesh with the clip with a greater surface area, allowing faster heating.

Although this fixture was prototyped around a steering wheel mounted airbag, it is envisaged that this approach could be used for additional vehicle mounted airbags. Easy steering wheel removal also aids swift removal of the instrument panel. The complete IP itself could also be retained with active quick release fixings. This would open up the possibility of then being able to remove a large polymer component whilst removing the airbags. With the airbags removed, retrieval of the IP becomes much easier. By attaching the airbag with the same fasteners as the airbag systems, a change of tools is not required. The idea of IP removal is further explored later in this chapter.

There is of course the additional safety benefit for dismantling technicians of removing a live explosive device from the ELV. Operator safety during dismantling must of course be ensured.

This prototype device was a dual demonstrator for both the wheel removal and the hot probe concept. However, it is accepted that placing a heated probe near what is essentially a solid fuel rocket detonator is not ideal. In an optimised system, a cryogenic or very low transition temperature SMA should retain dangerous devices such as airbags. A freeze spray can then trigger these devices, without compromising the stability of the pyrotechnic charge.

4.3 CASE STUDY 3.

Additional ADSM Technologies for ELV Applications- Shape Memory Hook and Loop Fasteners

Introduction

Throughout this research project, many existing disassembly and fastening solutions have been analysed. Among these were the 'hook and loop fastener', usually generically referred to by the trademark 'Velcro'. Velcro is a very interesting material for assembly as it provides a very tough and durable fixing solution with excellent repositionability. Using the idea of 'Velcro', as our model, SMP hook and loop fasteners were fabricated to investigate the potential of creating a repositionable fastener that will relax when elevated in temperature⁸⁶.

4.3.1 Experimental Method

Before any experiments could be completed to analyse the properties of various grades of 'Velcro', a batch of 'Shape Memory Hook and Loop Fastener' (*SM-HALF*) had to be created. Only one half of hook and loop assembly, the hook, was fabricated. This was chosen for ease of fabrication, with the expectation of the hooks relaxing under thermal stimulus. The hooks were made by constructing a silicon mould from an existing commercial Nylon hook pattern. Two-part SMP resin was then gravity cast into the mould creating the required SMP hooks (*Figure 4.7*).

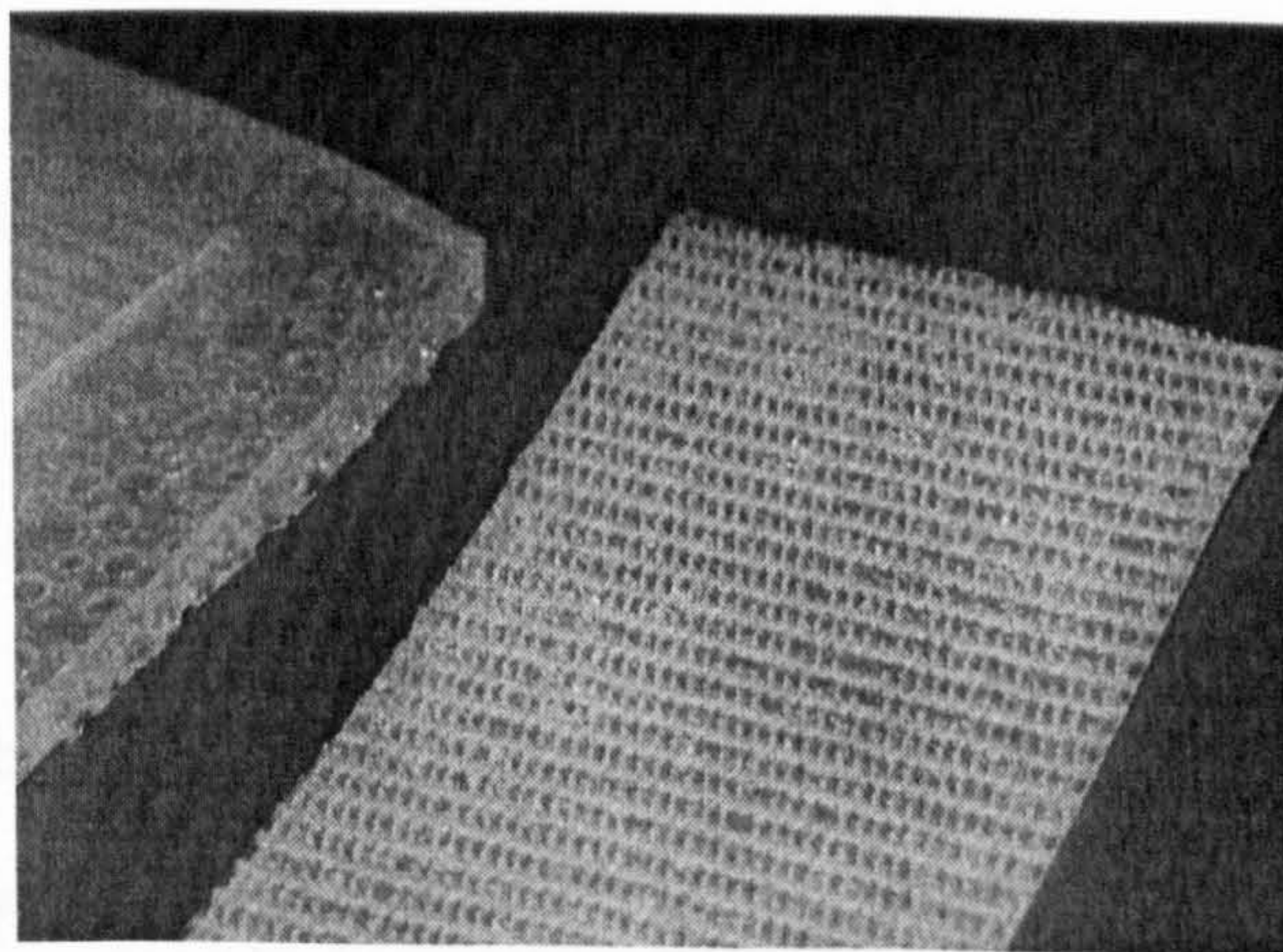

Figure 4.7. SM-HALF. Flexible Silicon Mould from Which the Hooks Were Cast and the Moulded SMP Hooks

A series of experiments were undertaken to assess the performance of existing commercially available Velcro systems, and combinations of existing loop samples with the SMP hook system. These tests were conducted by adhering 25mm x 25mm 'hook' samples to degreased metal plates that were supported horizontally. A 25mm x 25mm sample of the 'loop' part of the system was adhered to a 25mm x 25mm degreased steel plate, with a steel hook brazed to the centre of its underside. The two halves of the Velcro system were then pushed together so that they joined. A test load $\approx 500\text{g}$ was then hung from the bottom of this plate. The whole assembly was then hung carefully in an oven. Care was taken to ensure that the samples hung correctly so as not to be loaded in peel (Figure 4.8).

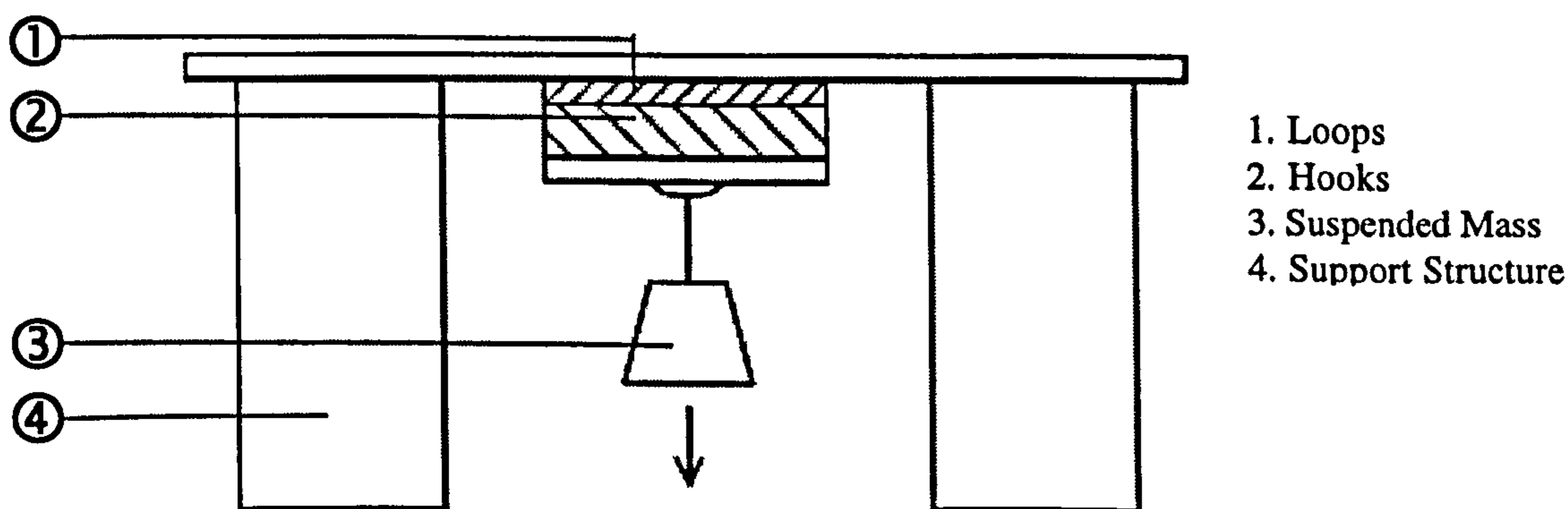

Figure 4.8 Velcro Evaluation Test Rig, Placed in an Oven to Observe Separation Temperature

Each assembly was subjected to an increasing temperature- time profile, until the weights fell from their suspended position. The failure temperature was noted, as well as the failure method. Tests were stopped at 200° as this is far in excess of the required temperatures for 'in car' automotive applications.

As this investigation is an assessment of the Velcro variant only, and not the adhesive, the tests limited by the adhesive properties were repeated to summarise the Velcro performance. The Velcro types that could not be simply evaluated due to the limitations of their adhesive types were then mechanically attached to the test rig by pulling the sample tight and clamping the edges of the sample in place. This allowed the performance of the Velcro alone to be assessed without being compromised by the adhesive performance.

4.3.2 Results

The table overleaf (table 4.1) represents the range of different grades of Velcro tested. Some commercial Velcro types only differ in their backing adhesive types. These were still tested to observe if this made any difference to their performance. The failure temperatures were deemed acceptable if the failure temperature was 105 degrees or above. Most Velcro types fell into this category. Table 4.1 highlights a few totally different existing commercial grades of Velcro for comparison. Table 4.2 represents a summary of the different Velcro types, and details of which samples need further investigation.

Results:

Test no	Type	Velcro Product code	Adhesive to rig	Failure Temp./ °c	Failure mode
1	Hook 88 Loop 1000	0115 0114	0115 0114	97	Adhesive on Hooks
2	Hook 88 Loop 1000	0174 0114	0174 0114	122	Loops stretch and let go
3	Hook 88 Loop 1000	0172 0114	0172 0114	100 Hooks stretch 130 Loop adhesive stretch, inducing peel, 145 fail	
4	Hook 88 Loop 2000	8299 backing 0599 backing	Permabond EDS 2 part epoxy	Still intact at 200°, although adhesive starting to peel	
5	Texacro hook 70 Loop71	Texacro	Permabond EDS 2 part epoxy	120, loops stretching 135, hook adh. peeling 200, still holding	
6	MVA *8 Loop1000	9972 0174	9972 0174	124	Adh. fail on hooks
7	MVA *8 Loop1000	PVC velstick	velstick	113 starts to loosen 138 Velcro fails	
10	Moulded nylon 552	'Speciality'	Permabond EDS 2 part epoxy	Barely hold weight, and susceptible to misalignment, However, holds to 167, adh fail	
11	Moulded nylon 555	'Speciality'	Permabond EDS 2 part epoxy	105	Adh fails, inducing peel
12	Ultra 8 Loop 1000	0172 0114	0172 0114	142	Loop adh fails, inducing peel
13	HTH 706 Loop 1000	0172 0114	0172 0114	124	Loop adhesive failure
14	HTH 805 Knit loop 3610	9915 9214	9915 9214	113	hook adhesive failure
15	Unidirectional HTH 719 Loop 2000		Permabond EDS 2 part epoxy	145	Velcro failure
15	Edgeclip hook 88, Heavy Duty ABS loop		Velcro adhesive	102	Velcro failure from the loops
16	Veltrack no 2 Hook 88, Loop 1000		Veltrack clips	104	Velcro failure
17	Stainless Velcro	Hi- garde Hook and loop	145	162	Permabond failed, Velcro intact
18	Velcro sew 'n' stitch		Self adh hook, 2 part epoxy loop	98	Hook adh fails
18	Heavy duty moulded hook, woven loop		Self adhesive backing	123	Loop adhesive
19	SMP velcro hook/ HD woven loop		Double sided tape/ self adhesive backing	85	Loop release
20	SMP velcro hook (sample 2)/ HD woven loop		Double sided tape/ self adhesive backing	85	Loop release

Where two Velcro or adhesive, types are listed- the first is the 'hook' part

Table 4.1. Thermal testing of commercial Velcro Samples

Velcro Type	Performance Summary	Potentially Suitable for Automotive Applications?
Hook 88	Good performance. Too temperature resistant for releaseability	Yes
Hook 70	Good performance	Yes
Hook moulded Nylon 555	Not mechanically robust, subject to misalignment	No
Hook moulded Nylon 552	Not mechanically robust, subject to misalignment	No
Hook HTH 706	Needs further investigation	?
Hook HTH 805	Needs further investigation	?
Hook HTH 719	Fair performance (narrow safety margin~ 20°C)	Yes
Hook MVA *8	Fair performance (narrow safety margin~ 20°C)	Yes
Hook Ultra 8	Suffers adhesive failures, needs investigation	?
Hook Hi-garde	Excellent temperature resistance	Yes
Hook sew 'n' stitch	Suffers adhesive failures, needs investigation	?
Hook HD Moulded hook	Needs further investigation	?
Hook SMP	Failure temp. too low	No
Loop 1000	Fail 120+	Yes
Loop 2000	Good temperature resistance	Yes
Loop 71	Fair performance (no safety margin)	No
Loop Nylon 552	Not mechanically robust, subject to misalignment	No
Loop Nylon 555	Not mechanically robust, subject to misalignment	No
Loop Knit 3610	Needs further investigation	?
Loop HD ABS	Failure temp. too low	No
Loop Hi Garde	Excellent temperature resistance	Yes
Loop sew 'n' stitch	Suffers adhesive failures, needs investigation	?
Loop HD Woven Loop	Needs further investigation	?

Table 4.2 Velcro Performance Summary

The performance of some Velcro systems was masked by the failure of the adhesive.

Performance of the remaining Velcro types was re-evaluated by *clamping* the sample in place and heating the assembly. The re-evaluation of the remaining samples is illustrated in table 4.3

Velcro Type	Performance Summary	Potentially Suitable for Automotive Applications?
Hook Ultra 8	125 ⁰ C, Hooks elastically deform	Yes
Hook HTH 706	150 ⁰ C, Hooks elastically deform	Yes
Hook HTH 805	Low mechanical strength, hooks weaken at 120 ⁰ C	No
Hook HD moulded hook	180 ⁰ C hooks stretch	Yes
Hook Sew 'n' stitch	Hooks stretch at 110 ⁰ C	No
Loop Sew 'n' stitch	loops fail at 110 ⁰ C	No
Loop 3610	Low mechanical strength, fail at 110 ⁰ C	No
Loop HD woven loop	140 ⁰ C, loops stretch	Yes

Table 4.3 Further Evaluation of the Mechanically Clamped Samples

4.3.2.1 Results of the SM-HALF Performance

The shape change of the SMP hooks can be clearly seen in figures 4.9 and 4.10. The SM-HALF functions perfectly and repeatably as if it were a conventional Velcro. Once elevated in temperature to above T_g , the hooks relax and extend, losing their integrity and allowing the joint to separate.

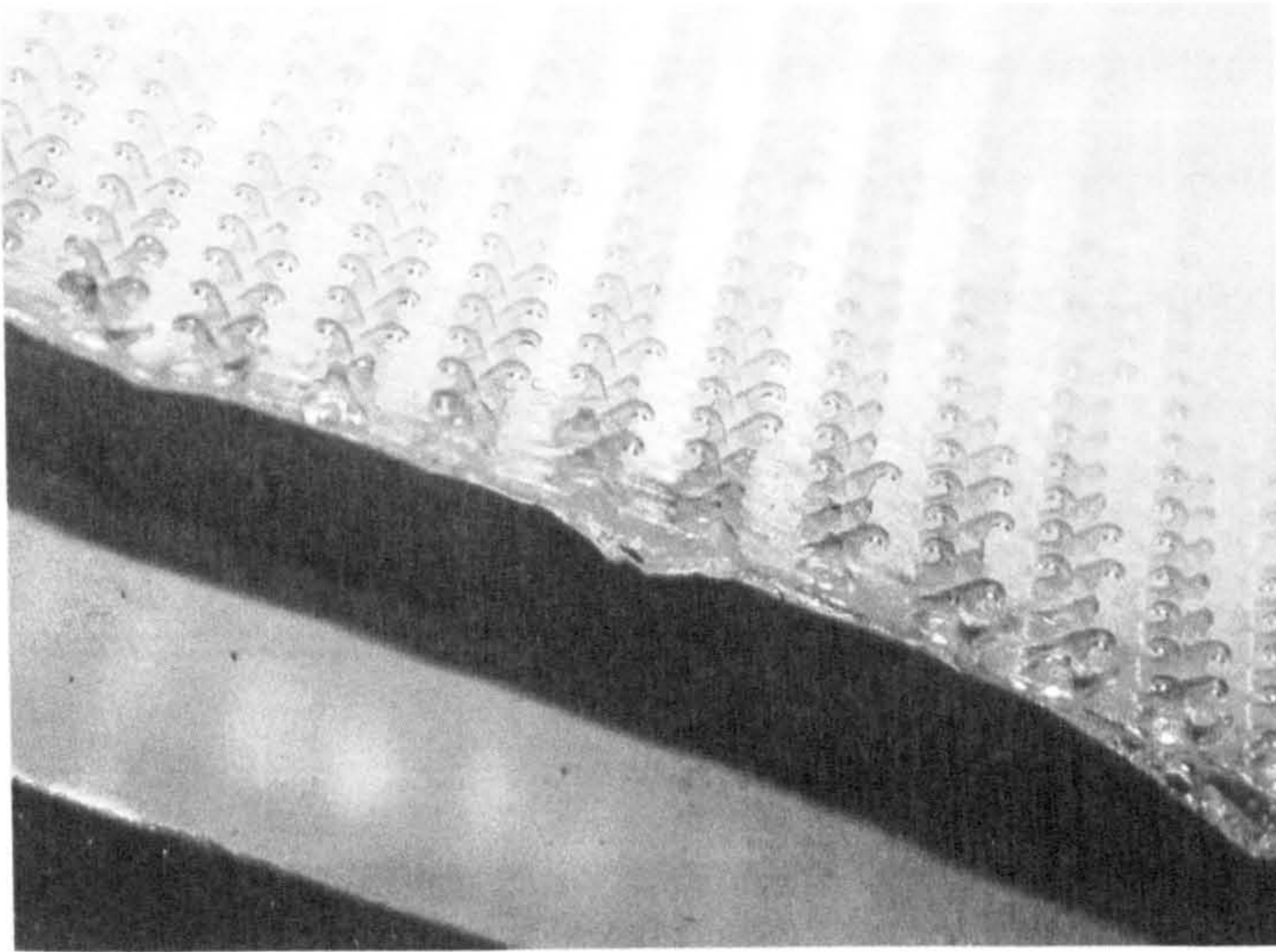

Figure 4.9 SMP Hooks in Their Closed Position- Temperature below T_g

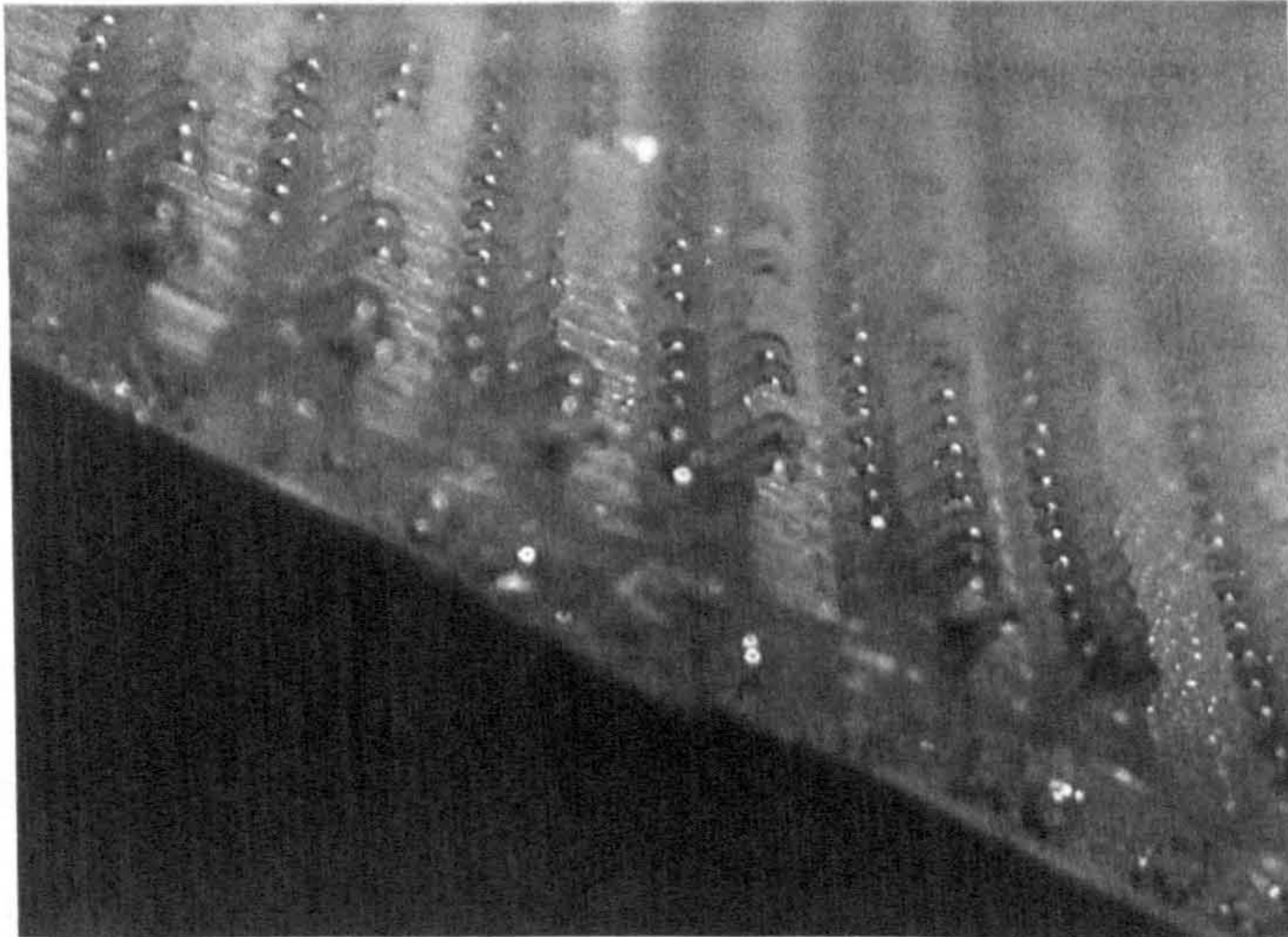

Figure 4.10 SMP Hooks in Their Open Position- Temperature Above T_g

4.3.3 Conclusions

4.3.3.1 Velcro Types

From examining the various grades of Velcro available, it can be seen that some existing Velcro grades could be useful for creating a releasable, *repositionable* method of assembly. The Velcro types are Hook 70, Hook HTH 719, Hook HTH 706, Hook MVA *8, HD moulded hooks, HD woven loops and Loop 1000. Only *one* of these types needs to be incorporated into a system, as only one *half* of the system has to release.

Hook 88, loop 2000, Hi-garde hook and loop and Heavy Duty moulded hook, have excellent performance, but they are not suitable for 'releasable' applications due to their temperature resistance. Releasing these systems would therefore consume more energy than a lower temperature solution.

All of the various grades of Velcro hook that are suitable for use in releasable systems, are constructed from either a moulded Nylon material, or a woven Nylon Filament. The T_g for Nylon 6 is 50°C , but the melting point (T_m) is around 250°C . It can be concluded that the activation temperature of these systems can be tailored to a particular activation temperature by changing the material specification. Using a polymer such as PC, with a T_g of 150°C would create a Velcro system releasing at higher temperatures, having a continuous use temperature of around 115°C . This would however increase the cost of the system significantly due to the fact that PC is a more expensive thermoplastic⁸¹. The Hooks all failed elastically under elevated temperatures. They all returned to their moulded shape and were able to be used again once cooled.

Polyamides (nylons) are subject to moisture absorbency, which is illustrated by the slight variance in performance observed. The experimentation was not conducted in a humidity-controlled environment, and the samples were stored in the lab in a cool dry box, away from any light source⁸¹.

4.3.3.2 Adhesive Types

Additional results from the tests show that various adhesive grades are releasable when heated. It is plausible that these could be used to create disassembling systems.

Of the tests that exceeded the 200 degree threshold (no's. 4, 5), the adhesive media was the Permabond EDS two part epoxy. This has to be heat cured at 60 degrees for 20 minutes,

and is therefore not suitable for high volume production. It did however allow the integrity of Velcro structures to be proven.

Adhesive 0114 failed between 124 degrees and 145 degrees, suggesting surface preparation is essential to obtaining satisfactory joint integrity. 0114 adhesive is currently only specified as an adhesive for the 'loop' part of the system, which is by nature a more flexible part of the system. The temperature range and release temperature of this adhesive meets the specification for automotive applications⁸⁴.

Ideal thermal performance for Velcro in vehicle applications is 40° to 125°C, for 1-2k cycles⁸⁴. Although cycle testing has not been conducted, this experimentation does illustrate which types of Velcro warrant further investigation.

4.3.3.3 SM-HALF Observations

SM-HALF reliably and repeatably triggers at 85 degrees. There is no stretching or partial failure; only a sudden release due to the sharp drop in modulus of the SMP. However, like the door glass retaining channels it would not be suitable for automotive applications until a SMP formula with a higher T_g becomes commercially available.

If SM-HALF is used as a 'drop in' replacement for bonded joints, the integration of the system into vehicles will require no design changes other than the assurance that the added thickness of a Velcro joint over a bonded joint is acceptable.

SM-HALF is a viable self release technology for applications existing in lower ambient temperatures than road vehicles (sub 60°C assemblies). It has the potential to be a cheap and reliable disassembly technology, requiring no expensive changes to implement.

4.3.4 Further work

Further tests on '0114' adhered specimens should be conducted to assess the reliability of the adhesive in a variety of conditions. Inspired by these results, further work on releasable adhesive and substrate systems is under investigation as a part of the EU Framework V project on 'Active Disassembly Using Smart Materials (years 2000- 2003)'. The results of these experiments are not discussed within this thesis.

From the observations of the thermal integrity of the Hi-garde system, Hi-garde hook and loop may be useful however for creating reliable, non-permanent electrical connections due to the stainless hook and loops electrical conductivity.

The '*releasable hook fastener*' that was tested released reliably and predictably. This could be used in applications where you would normally consider 'Velcro', and is as repositionable as is standard 'Velcro'. However, when the temperature of the system is elevated to above the T_g of the SMP, the hooks relax and the assembly self separates.

A second scenario could be envisaged to explore the potential of SM-HALF. In this scenario the 'hook' part of the system is again moulded from SMP. Just like conventional 'Velcro', the system is repositionable. However, instead of a 'releasable hook fastener', a '*retaining hook fastener*' could be created. The SMP hooks could be initially moulded in a very tight hook formation, and then heated and manipulated into a 'relaxed' hook shape. The joint could then be assembled and repositioned indefinitely. Once the position was satisfactory, the assembly could then be warmed above the T_g of the SMP. The warming of the installed part would cause the hooks to regain their 'tight' formation due to the *shape memory effect*. Effectively the repositionable 'Velcro' hooks then becomes very securely attached to the loops making a semi-permanent joint. The Velcro would then only be separable at room temperature by forced mechanical separation and destruction⁸⁶.

SM-HALF would be suitable for use in highly modularised assemblies, to allow faster assembly, and eventually lead to faster disassembly. In the context of an automotive Instrument panel (IP), supplementary pieces such as the clock, the radio, and the instrument binnacle could be retained with Velcro.

4.4 CASE STUDY 4

Instrument panel fascias could also be retained with SM-HALF, as could polymer body panels. This could open up the possibility of creating a modular vehicle that can be personalised in the way a mobile telephone can be. This type of cosmetic modularity can extend product lifecycles, and be considered a green design feature.

(Figure 4.12) The key innovations from an ADSM perspective include Active

4.3.5 Further Trends in Product Modularity

We have already seen the expansion of the modular vehicle principle on the commercial market with the *Smart* car. The user can change body panels for this vehicle, either simply for cosmetic reasons, or to replace damaged panels. Further development of this concept is underway at GM, who are working on a concept called *AUTOonomy* (see fig 4.11). This vehicle uses a fuel cell powered skateboard type chassis, on which a number of different bodies can be fitted by the user, to provide anything from a sports car to a minivan, all on the same platform. Active fixing solutions can provide a means of achieving goals such as these, by providing ranges of high integrity fasteners that can be quickly and simply removed.

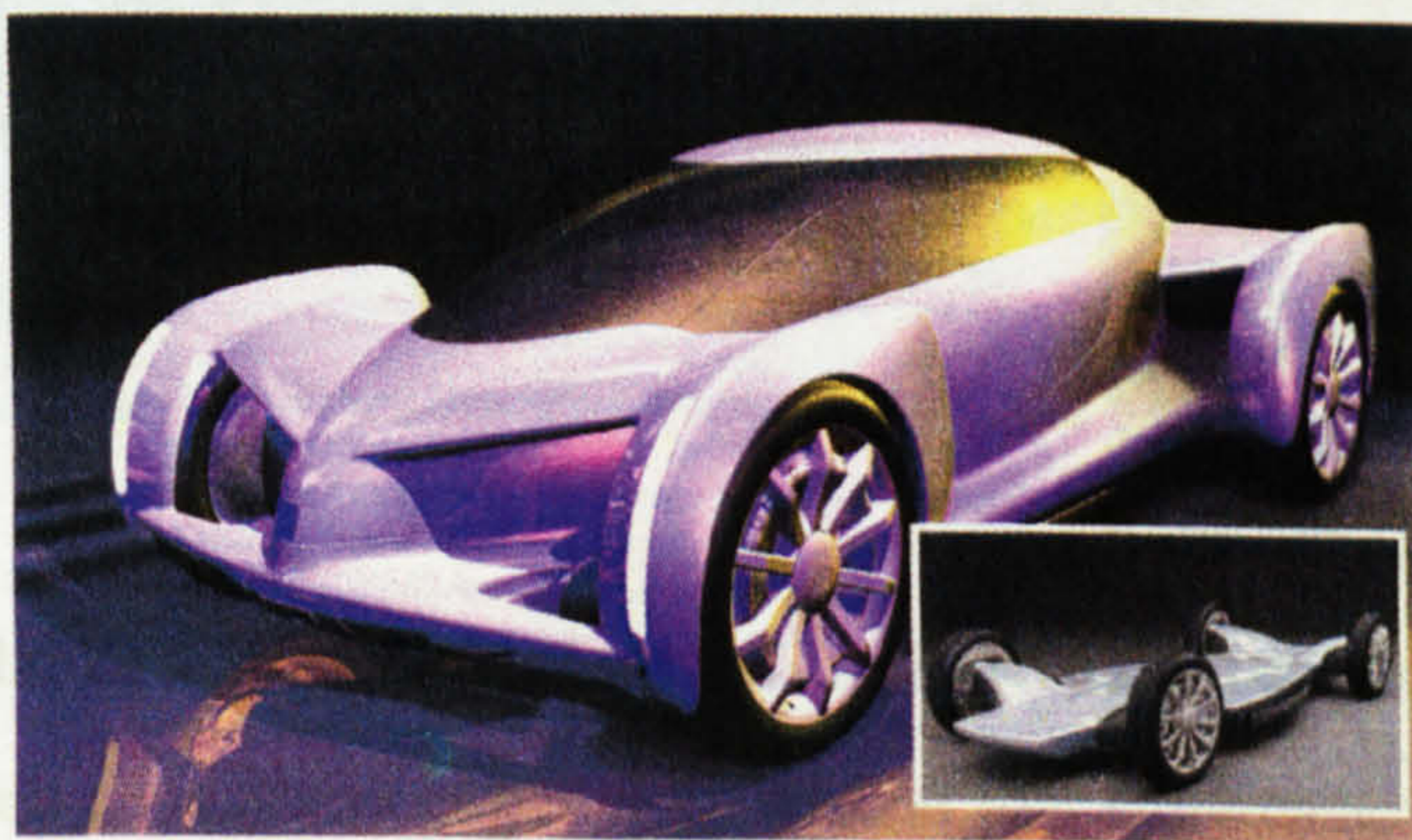

Figure 4.11 GM AUTOonomy (figure courtesy of the IAM and *Advanced Driving Spring* 2003)

This modular arrangement of vehicle architecture also lends itself to design for assembly maintainability principles, and other DFM, DfD and DfE methodologies for further evolving the automobile as a lower impact product than it has previously been.

4.4 CASE STUDY 4

The EcoCar Instrument Panel

Introduction

Brunel University, Warwick University, Imperial College and an independent consultancy, *Splendid Engineering* have been collaborating on a vehicle called 'The Splendid EcoCar' (Figure 4.12)²⁸. The key innovations from an ADSM perspective include: Active Disassembly using shape memory alloys, shape memory polymers, shape memory 'hook and loop' fasteners, and electrically triggered shape memory alloys. The EcoCar was fully developed into a working vehicle that appeared in German television¹⁰⁰ and at the UK BBC Tomorrows World Live Show 2002¹⁰¹.

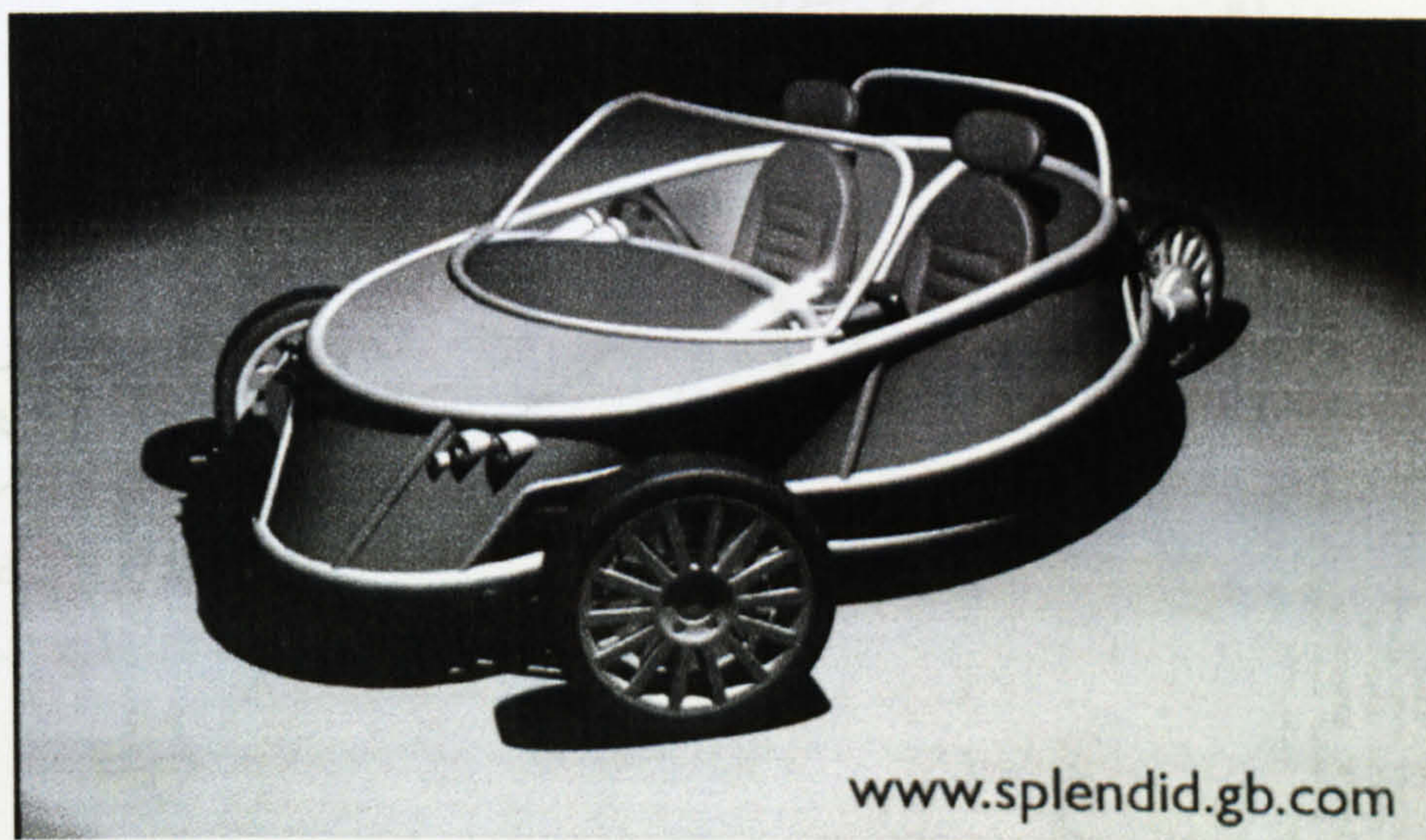

Figure 4.12 The Splendid EcoCar

Our contribution to the EcoCar is in the form of an 'Active Instrument Panel' (active IP). We have manufactured an instrument panel for the car that showcases all of our current technology, implementing the case studies presented in this thesis. The concept sketch for the EcoCar IP is illustrated overleaf in Figure 4.13. The active IP is an application of

ADSM solutions to date brought together as one whole system, as a complete assembly for incorporation into a working vehicle.

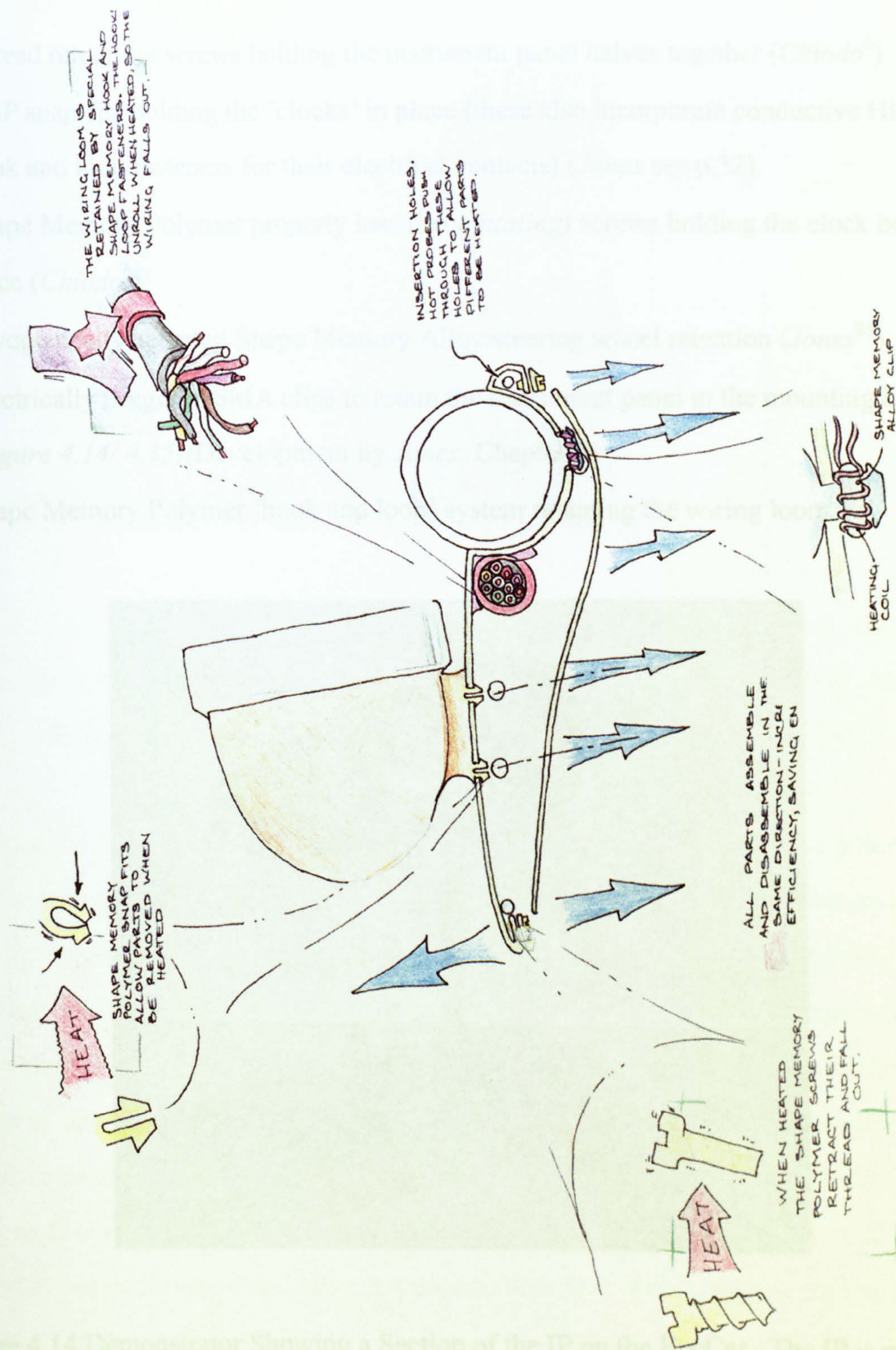

Figure 4.13 The Active IP for the EcoCar

The Active IP incorporates:

- Thread retracting screws holding the instrument panel halves together (*Chiodo*⁶)
- SMP snap-fits holding the 'clocks' in place (these also incorporate conductive Hi-garde hook and loop fasteners for their electrical contacts) (*Jones* see p.32)
- Shape Memory Polymer property loss (*decapitating*) screws holding the clock bezels in place (*Chiodo*⁶)
- Cryogenically actuated Shape Memory Alloy steering wheel retention (*Jones*⁸⁵)
- Electrically triggered SMA clips to retain the instrument panel to the mounting bar (*Figure 4.14/ 4.15*)(Development by *Jones*, Chapter 5)
- Shape Memory Polymer 'hook and loop' system retaining the wiring loom ⁸⁶.

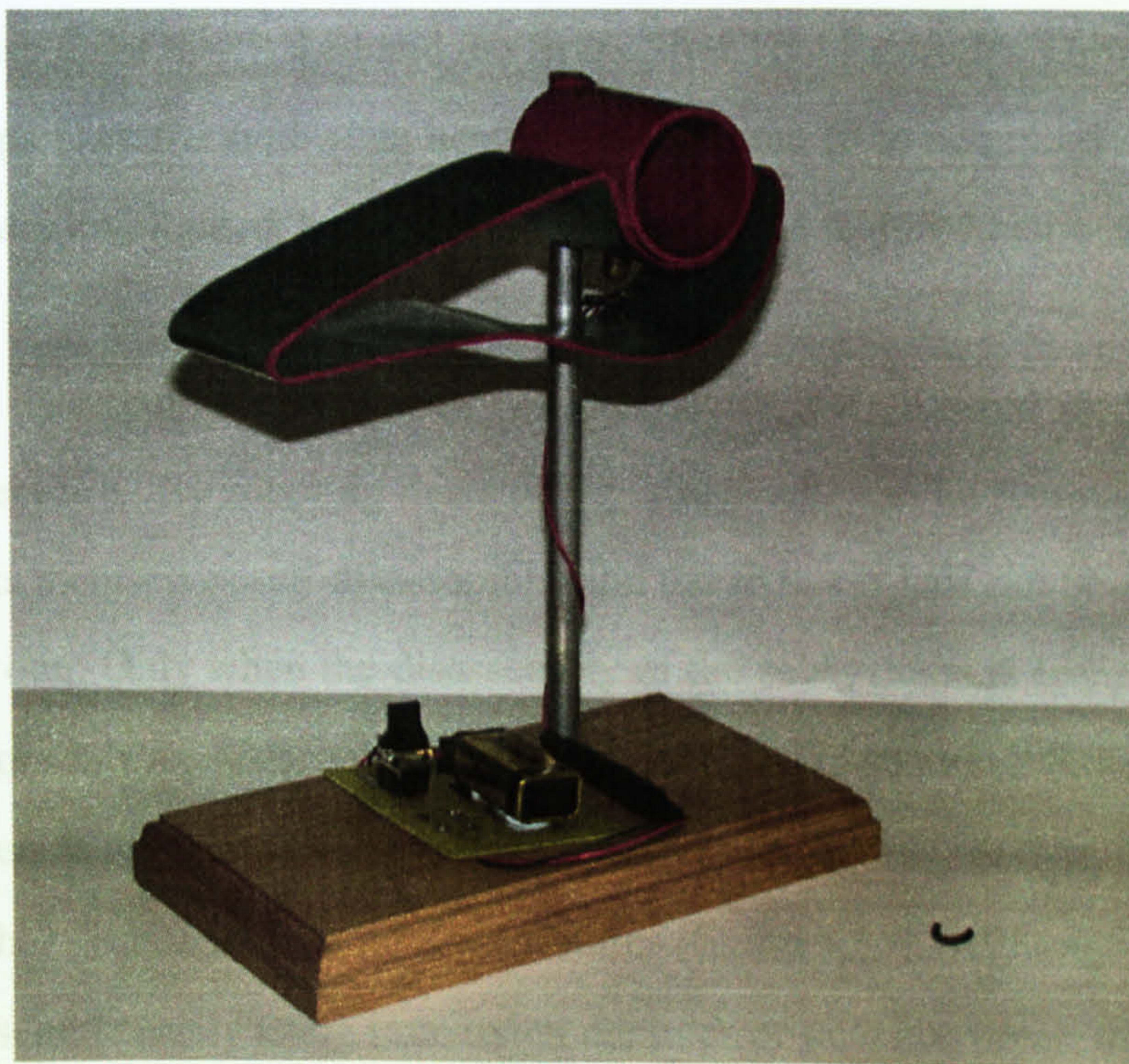

Figure 4.14 Demonstrator Showing a Section of the IP on the EcoCar. The IP is mounted onto the Rail with an Electrically Triggered SMA Clip

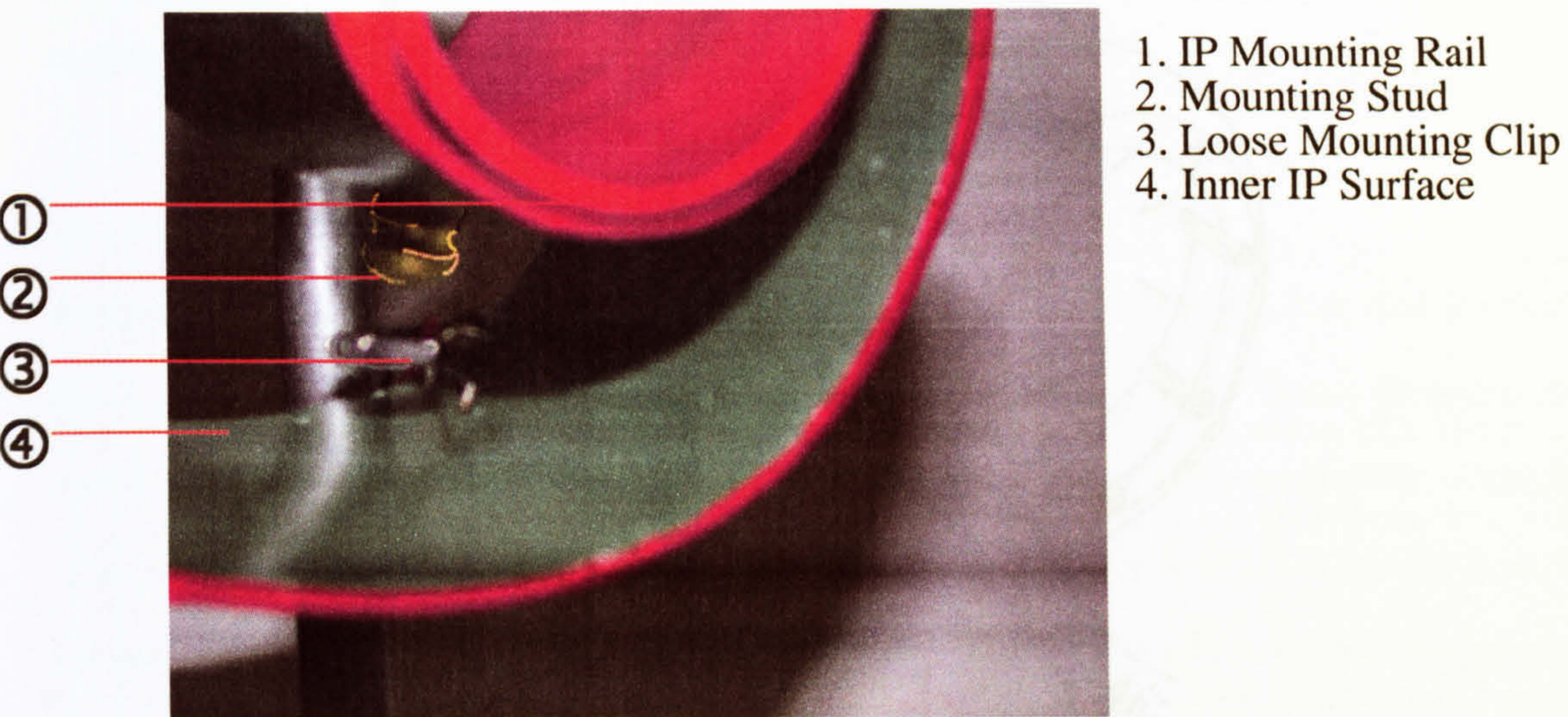

Figure 4.15 Close up of the IP Rail and the Brass Stud That Protrudes Through the IP. The SMA clip drops from the stud when heated, allowing the IP to be pulled clear. The stud edges are highlighted, and the clip is the grey part featured below the stud

The system will disassemble hierarchically as each device is engineered with a different transition temperature. By adopting this strategy, the clocks can be removed from the IP, before the clocks themselves self-disassemble, and the IP lower half can be removed before the wiring falls out. Only when the disassembly of the subsystems is complete, will the IP remove itself from its mounting rail. As already discussed in section 2.7, it is in the interests of green design that the IP has been realised as a modular design. The clock units themselves further disassemble using SMP fixtures (figure 4.16). Although the IP itself is too big to disassemble easily using immersion methods or on a conveyor, the small sub assemblies can be disassembled using hot water immersion. The schematic for the clock assembly is shown in figure 4.17.

Figure 4.17 View of Clock Body Allows Fast Internal Heating to Take the SMP Remover Screws About 2

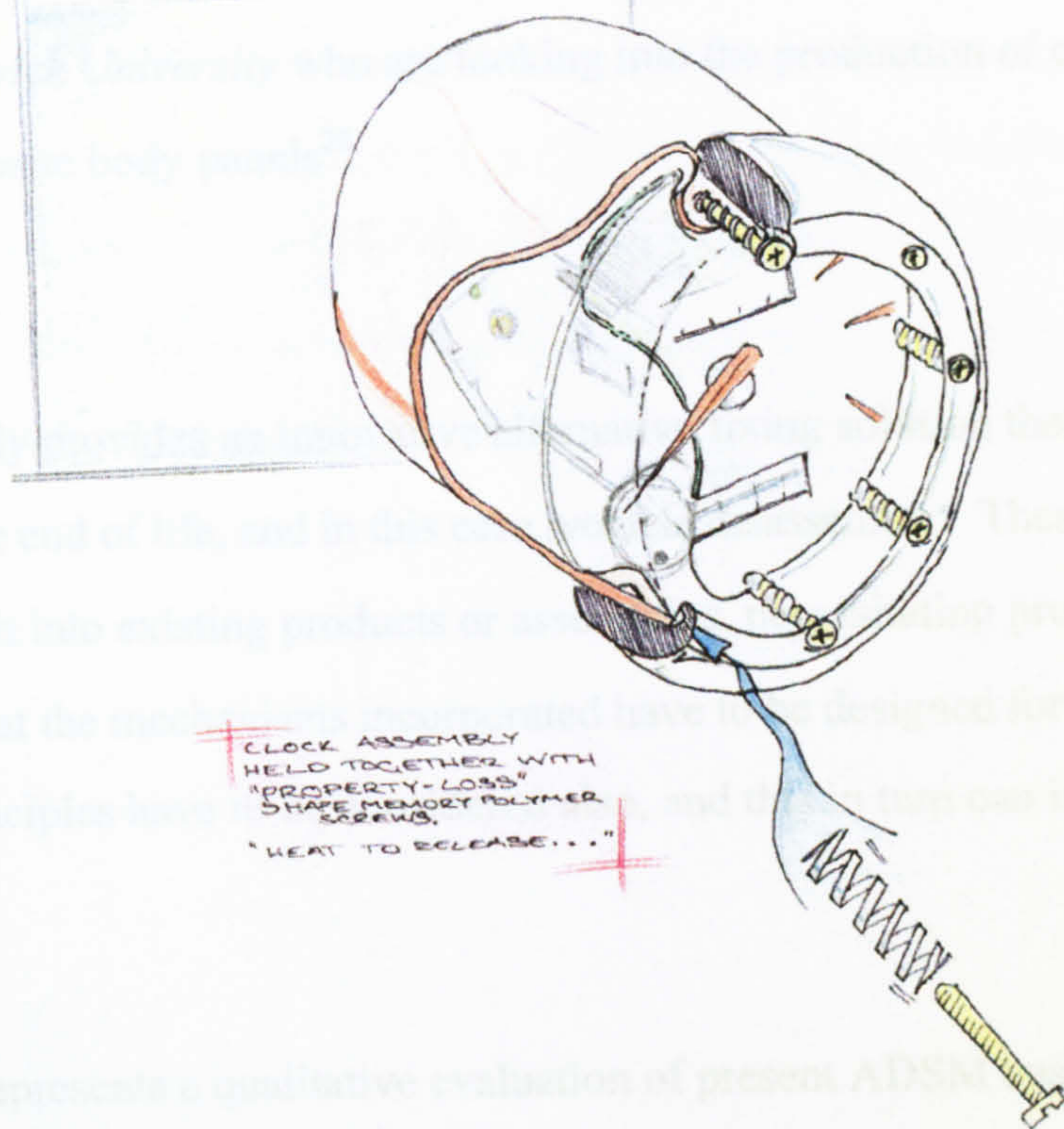

Figure 4.16 Cut Away Illustration of the Clock Assembly Held Together With SMP Bezel Screws

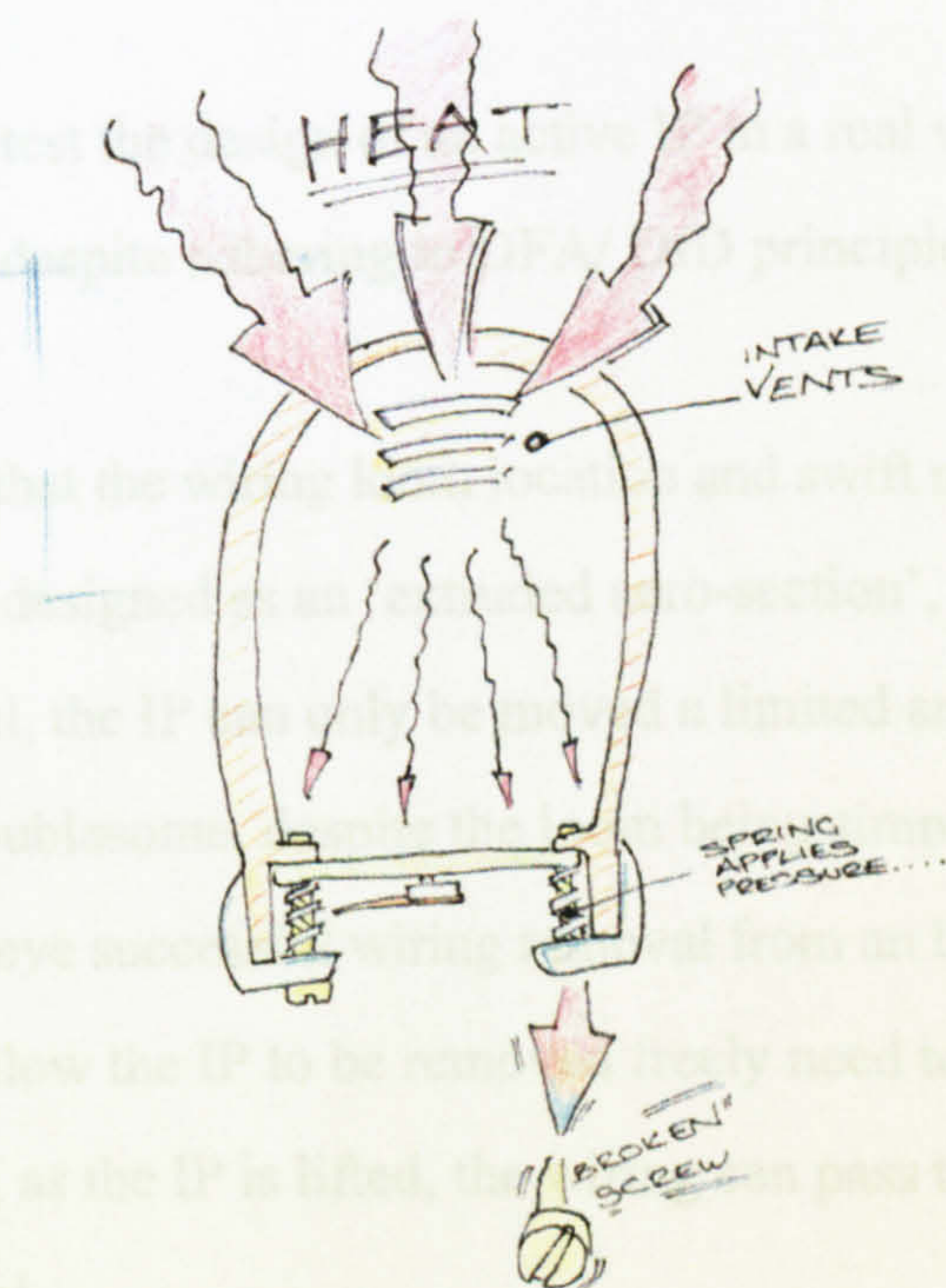

Figure 4.17 Vented Clock Body Allows Fast Internal Heating to Take the SMP Retention Screws Above T_g

Other partners contributing to the project include *Agrol* who are working with *Imperial College*, and are involved with the development of Cellulose Ethanol Fuels from biomass sources, and *Warwick University* who are looking into the production of compostable sustainable composite body panels²⁸.

4.5 Summary

Active disassembly provides an innovative alternative fixing solution that aids product disassembly at the end of life, and in this case, vehicle disassembly. These mechanisms will not usually retrofit into existing products or assemblies, necessitating product redesign. Due to the fact that the mechanisms incorporated have to be designed for removal, design for assembly principles have to be considered also, and this in turn can improve product efficiency.

The EcoCar IP represents a qualitative evaluation of present ADSM design solutions to aid swift economic part recovery.

The Eco IP allowed us to test the design of an active IP in a real vehicle, and showed us the limitations of the design, despite adhering to DFA/ DfD principles.

The exercise highlighted that the wiring loom location and swift removal can still be difficult. Despite the Eco IP being designed as an 'extruded aero-section', with the wiring passing through it. Upon removal, the IP can only be moved a limited amount until the wiring is withdrawn. This was troublesome, despite the loom being simple when compared to a modern vehicle. To achieve successful wiring removal from an IP, transverse wiring passages or 'cuts' that allow the IP to be removed freely need to be incorporated. By designing in this feature, as the IP is lifted, the wiring can pass through the cuts in the IP allowing swift IP removal.

In this overview economics are not considered. It can be seen that due to the swiftness of part recovery, many parts can easily be removed for economic reclaim and not just for directive compliance. Although the incorporation of Active Disassembly into host assemblies will carry a financial cost, the degree to which this can be offset is dependant on the value of the parts selected for recovery. For the manufacturer also, there can be benefits of ADSM incorporation. From a servicing standpoint, traditionally difficult jobs such as instrument panel removal can be made much simpler, cutting service time.

Chapter 5

Electrically Triggered Active Disassembly with No External Energy Input

5.1 ELECTRICAL DISASSEMBLY

AN INVESTIGATION INTO SELF POWERED MOBILE TELEPHONE DISASSEMBLY

From the series of ADSM case studies in Chapter 4, and the assessment of existing methods of triggering active disassembly, it is apparent that simple triggering of ADSM devices is one of the issues which will have to be resolved for the technology to move forward. Although satisfactory for smaller products, the high temperatures, magnetic fields or microwave triggers used on smaller products (see Chapter 2), are not practically applicable for large products such as vehicles. Electrical triggering could provide a fast, direct and efficient means for triggering ADSM.

A further refinement of the Active Disassembly concept was therefore investigated. As an initial prototype, systems of retainers were constructed to eject the battery of a mobile telephone when the end of life condition arises⁸⁷. There were two novel elements to this work:

- Electrically triggered ADSM devices
- Zero 'out of product' energy requirement.

Electrically triggered ADSM: by utilising SMA 'muscle wires', actuation systems were developed that would trigger not by external heat application, but by passing a current through the wire. The current flow provides the necessary rise in temperature for the shape memory effect to occur. In this instance the wire contracts with enough force to eject the battery from the host assembly. Muscles wires have been widely used in many applications before, including heat engines and novelty items³⁵, but this is the first example of their use for product disassembly.

This was also the first example of ADSM occurring with no energy input from outside the product. Previously, thermal energy has been applied to the assemblies by various means including microwave heating, induction heating, hot air convection, hot water immersion and direct heating with a hot probe. In this instance, it is only the electrical energy contained within the assembly that is utilised. It should however be pointed out, that although negligible by comparison to the energy required for actuation, there does have to be a small amount of external energy applied to actually signal *to* the device for triggering. In this instance, this was nothing more complex than the throwing of a switch.

5.2 ELECTRICALLY TRIGGERED DISASSEMBLY USING RESIDUAL BATTERY CHARGE

The candidate product used for the testing was a Nokia mobile telephone. It was hypothesised that even when an appliance no longer has enough battery power left to power the product, there is still useful energy left inside the battery. This energy could be used to power disassembly.

5.2.1 Method

To realistically replicate an EoL scenario, only batteries fully discharged in a telephone were used. In all cases the batteries would no longer power the telephones. The batteries then stood for several weeks. The power able to be delivered by the EoL batteries was

analysed by further discharging the 'dead' batteries through a 10-Ohm 1/4-Watt resistor (Figure 5.1).

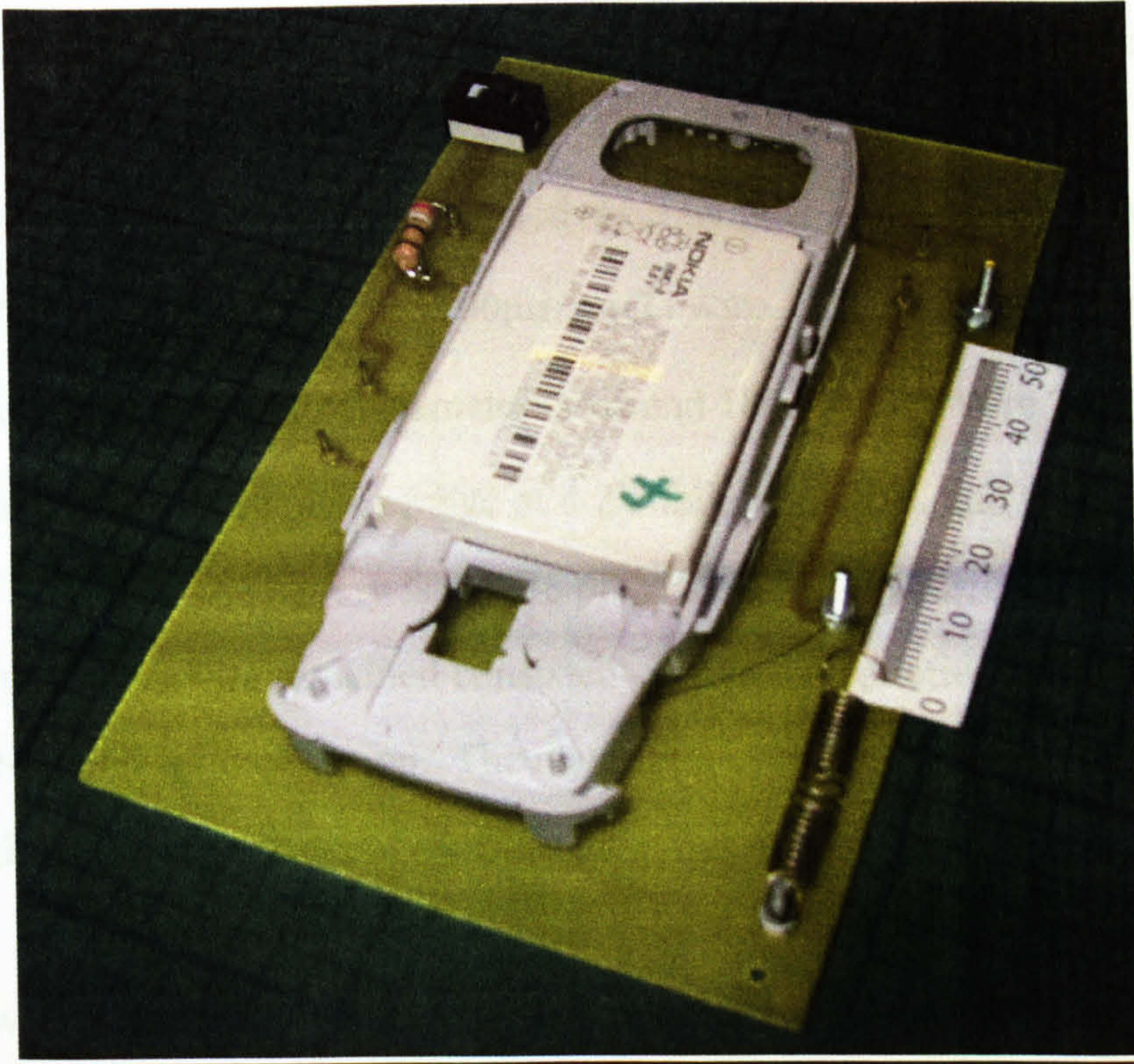

Figure 5.1 Switchable Battery Testing Rig. Discharge Resistor is to the Left, and the Scale on the Right Illustrates Muscle Wire Contraction

The experiment was initiated using new batteries, supplied by Nokia. A fully charged battery (*Nokia BMC-3*) can deliver an off load potential of up to 4.2 Volts, and has an energy capacity of 900mAh. These batteries were fully charged and then used in a normal fashion by two of the researchers in order to ensure the discharge pattern was indicative of real world use. The telephones were used in a metropolitan area until they expired (*a metropolitan area typically having good reception, and therefore high power is not required to connect to the network*). As ambient temperature has an effect on the amount

of potential across the terminals of the battery all testing was completed under a consistent lab temperature of 24⁰C.

A test rig was designed to allow a measurement of the residual energy of the battery and its potential to trigger an SMA 'muscle wire' (*Figure 5.1*). Muscle wire is a thin SMA wire that contracts along its length when activated by heat or electricity. The wire used was Mondotronics high-temperature 100 μ m Ni-Ti wire. The necessary current to trigger a muscle wire of 0.1mm (100 μ m) diameter is around 180mA for a wire 25mm long.

Between a battery terminal voltage range of 4.2V falling to 1.0V, and with a wire resistance of 7.5 ohms, the battery is able to provide sufficient current for activation.

Actuation time for the wire remained consistent within the batteries operating range, at just over one-second for contraction. The maximum cycle rate for the wire is around 50 cycles per minute if the wire is not overheated.

Three tests were completed to ascertain the properties of the discharged batteries. The first test was to investigate the batteries remaining capacity.

The batteries were placed into the test rig and drained through a 10-Ohm, 1/4-Watt resistor. Measurement of voltage and current were recorded against time to allow the residual battery power to be calculated. This test was repeated three times.

A second test was carried out to investigate the minimum amount of power needed for activation of the muscle wire. The battery was connected to the test rig and a current allowed to pass through the wire until the battery had run down to a level where contraction no longer occurred. Measurement of the voltage and current drawn against time were taken.

The third test was designed to assess the repeatability of triggering the muscle wire and ascertain the possibility of triggering multiple actuators. It also allowed investigation into whether recovery time affects the amount of energy able to be delivered by the depleted battery. The battery was placed into the test rig and the muscle wire triggered for 10 seconds then allowed to relax. This test was repeated every 30 seconds until the wire would no longer contract. These tests were then repeated using 5-second contraction times to see if the results for this test differed.

Upon completion of these energy assessments, a second round of design experiments were set up to implement actual ADSM design solutions within the mobile phone chassis to show 'active disassembly in practice'. Although not 'production refined', these solutions show practically how design for ADSM can be achieved, with working demonstrators as opposed to simple concepts.

Two experiments were set up. The first release mechanism involved the use of a muscle wire to compress a biasing spring, that would otherwise hold the battery in place. The retention mechanism is not unlike that of a conventional door latch. Upon contraction of the muscle wire the retaining tab is pulled back, allowing the battery to eject (*Figure 5.2*). This solution was called the 'Latch' solution. A schematic for the latch solution is shown in figure 5.3.

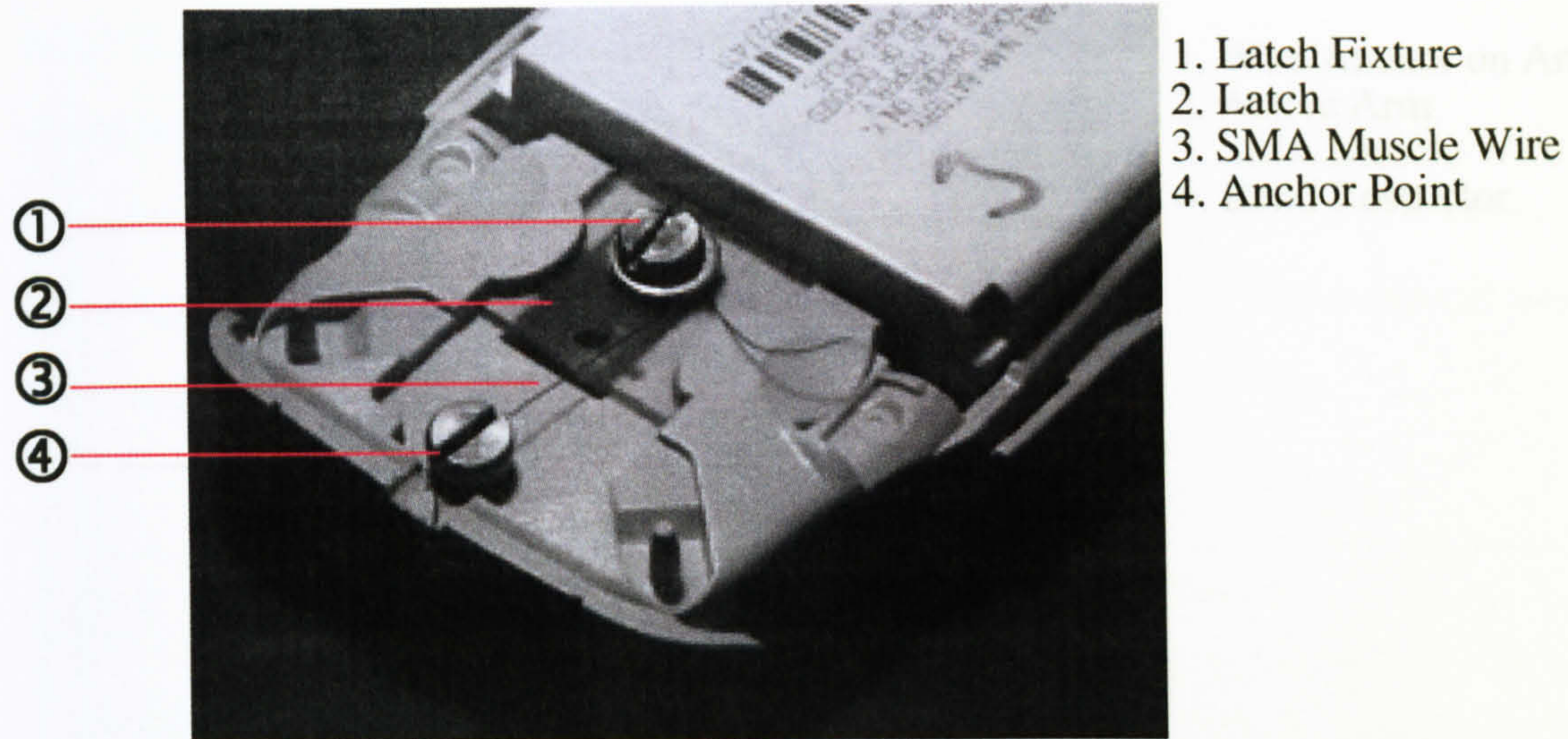

Figure 5.2. Solution 1, Ejection Mechanism Details

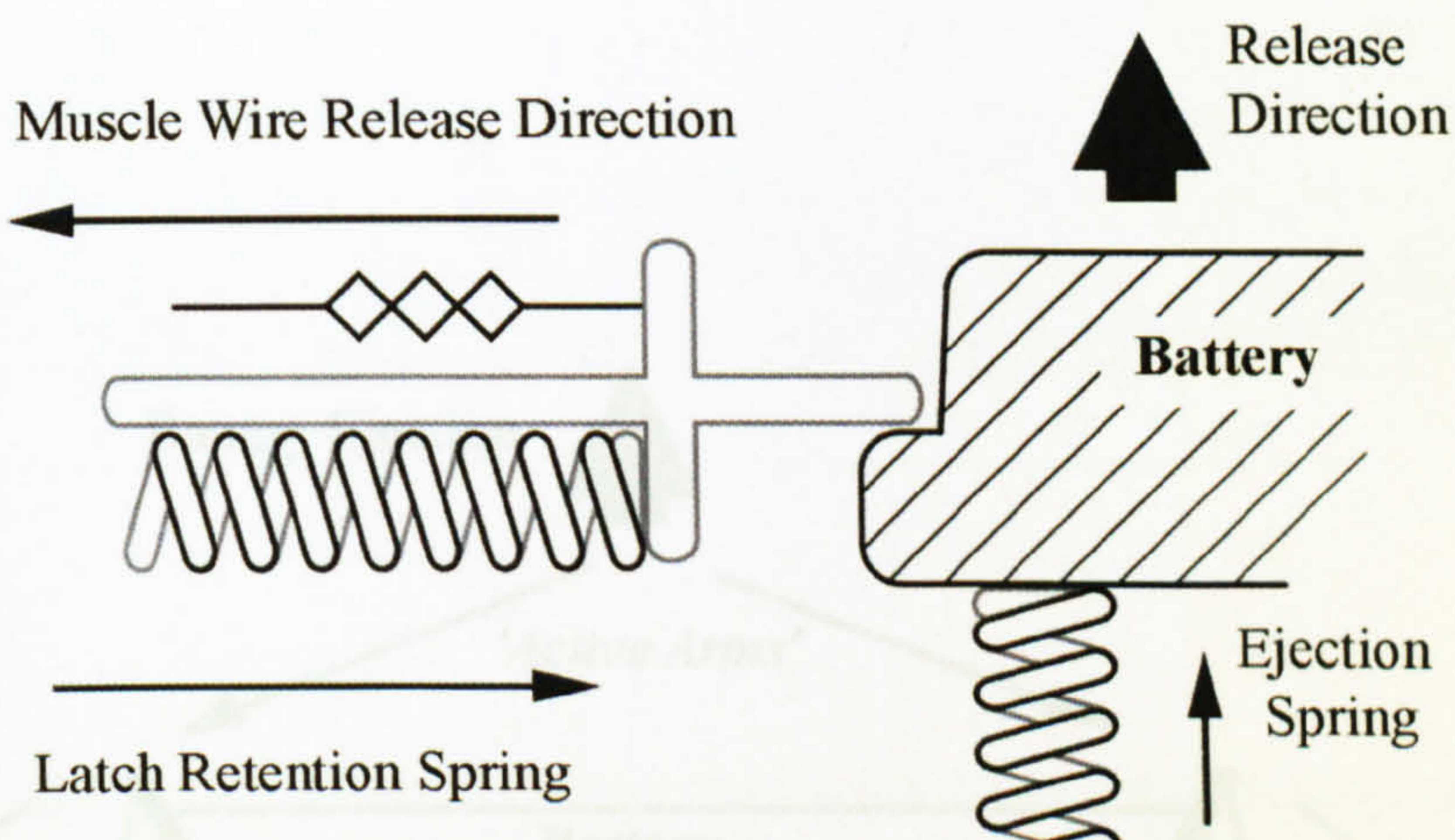
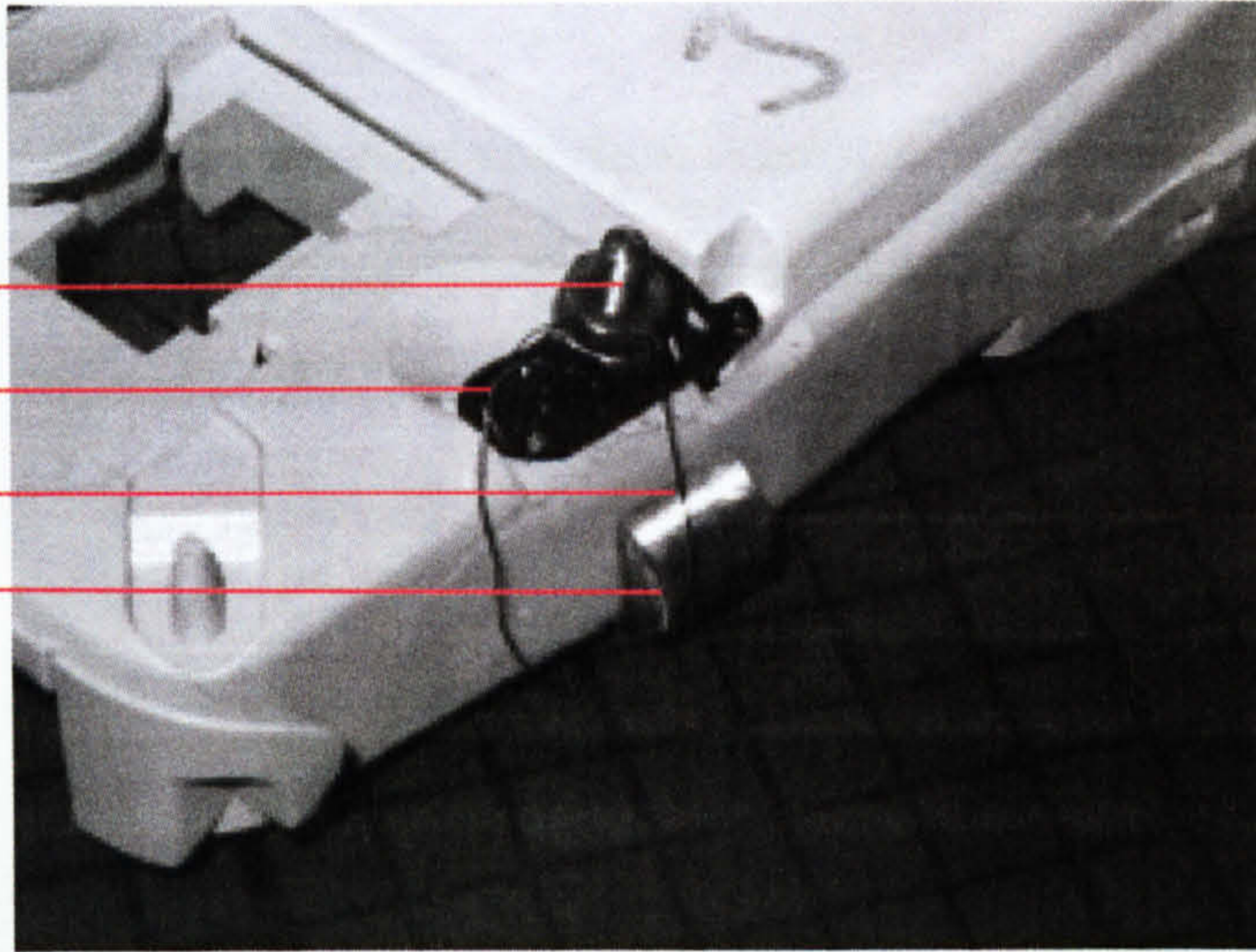

Figure 5.3 A Schematic for the Latch Solution.

The second design for battery retention was a modification of the existing battery retention mechanism. In this instance, a muscle wire pulls back the moulded bell cranks in the battery housing to cause ejection. This was titled the 'Active Arm' solution (*Figure 5.4*). A schematic of this solution is shown in figure 5.5.



1. Wire Anchor on Articulated Arm
2. Active Arm
3. SMA Muscle Wire
4. Bend Restrictor

Figure 5.4. Solution 2, Ejection Mechanism Details.

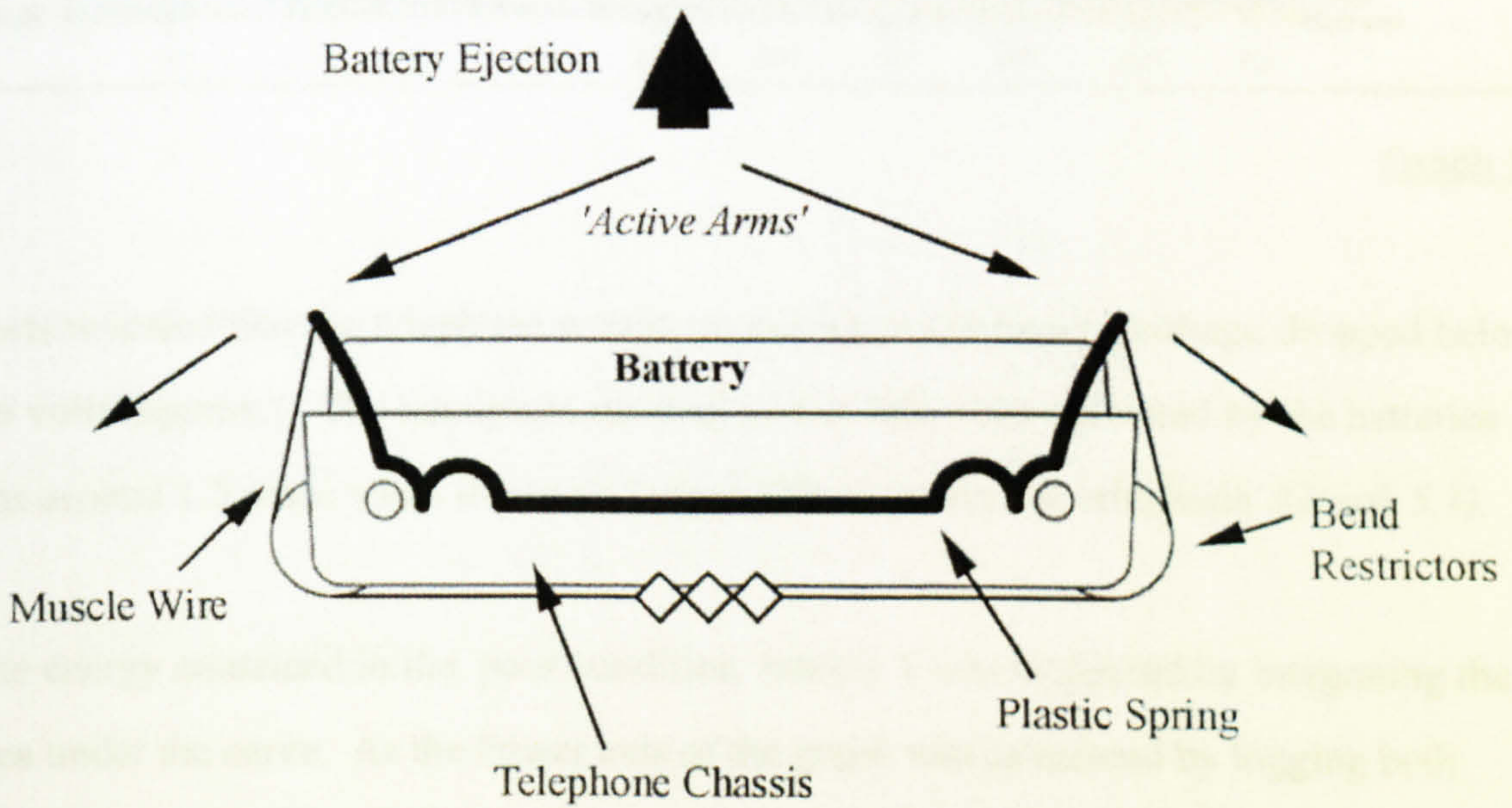
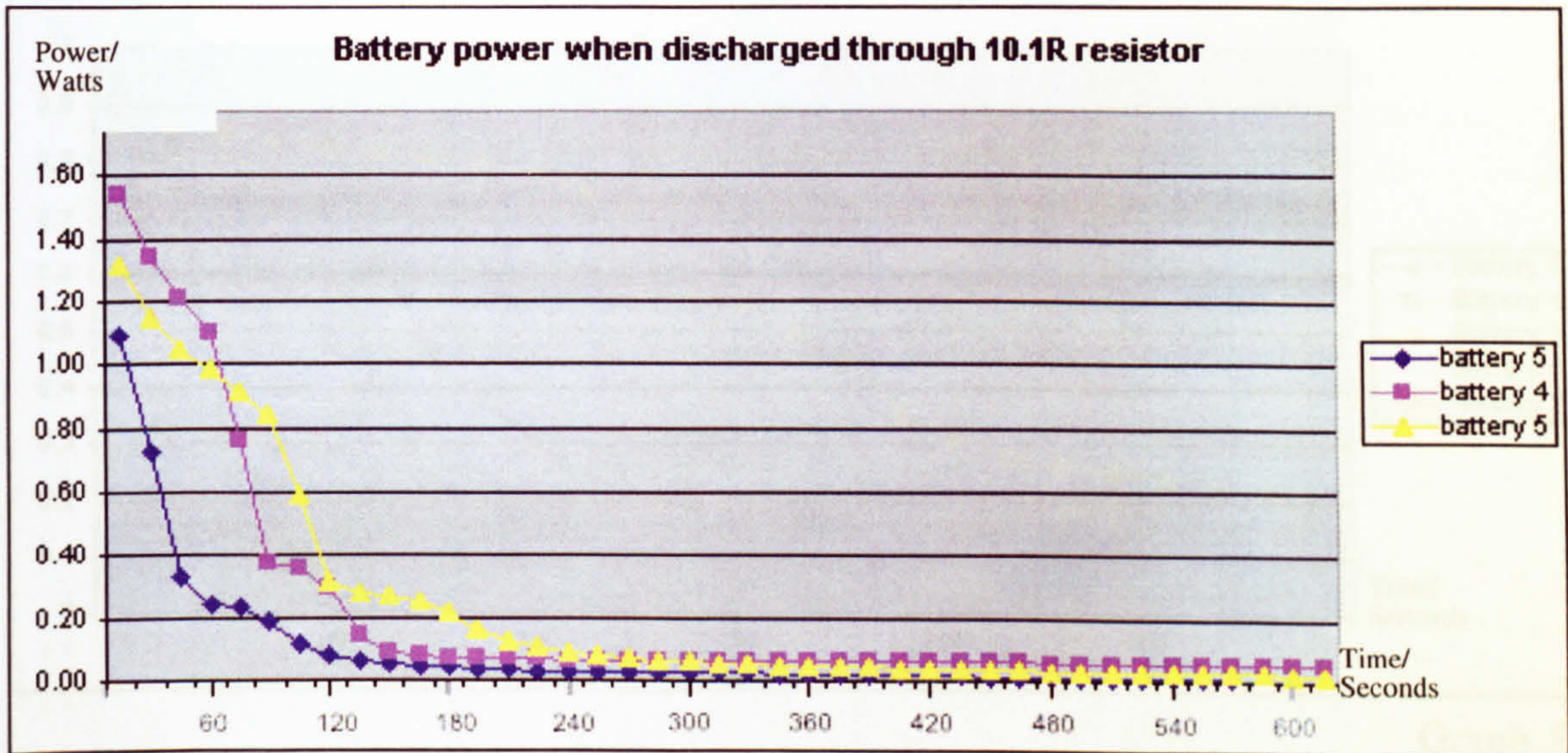

Figure 5.5 A Schematic of the Active Arm Solution

5.2.2 Results

From test 1, the power curve of three expired batteries was established (*Graph 5.1*). The power curve graph was plotted several times for each battery, but the graph illustrated is showing the *range* of curves that were established. A selection of batteries was used, but for clarity the plots that lay over other plots were discarded.



Graph 5.1

Tests revealed that the telephone would cut out when the battery voltage dropped below 3.6 volts (approx.). The maximum residual power able to be delivered by the batteries was around 1.5 watts when it was no longer able to power the telephone (*Graph 5.1*).

The energy contained in the poor condition battery 5 was evaluated by integrating the area under the curve. As the Power axis of the graph was calculated by logging both current and voltage against time (the resistance representing a constant), the area under the curve represents the energy contained in the battery in Joules. By using the *Simpson Method* of integration⁸⁸ (for curves that do not exceed a cubic function, but are of an

unknown equation), the area under the curve was established to be 42.8 units, equating to 42.8 Joules.

From experiment 2- Graph 5.2 shows how long the discharged batteries were able to keep a muscle wire contracted against a biasing spring.

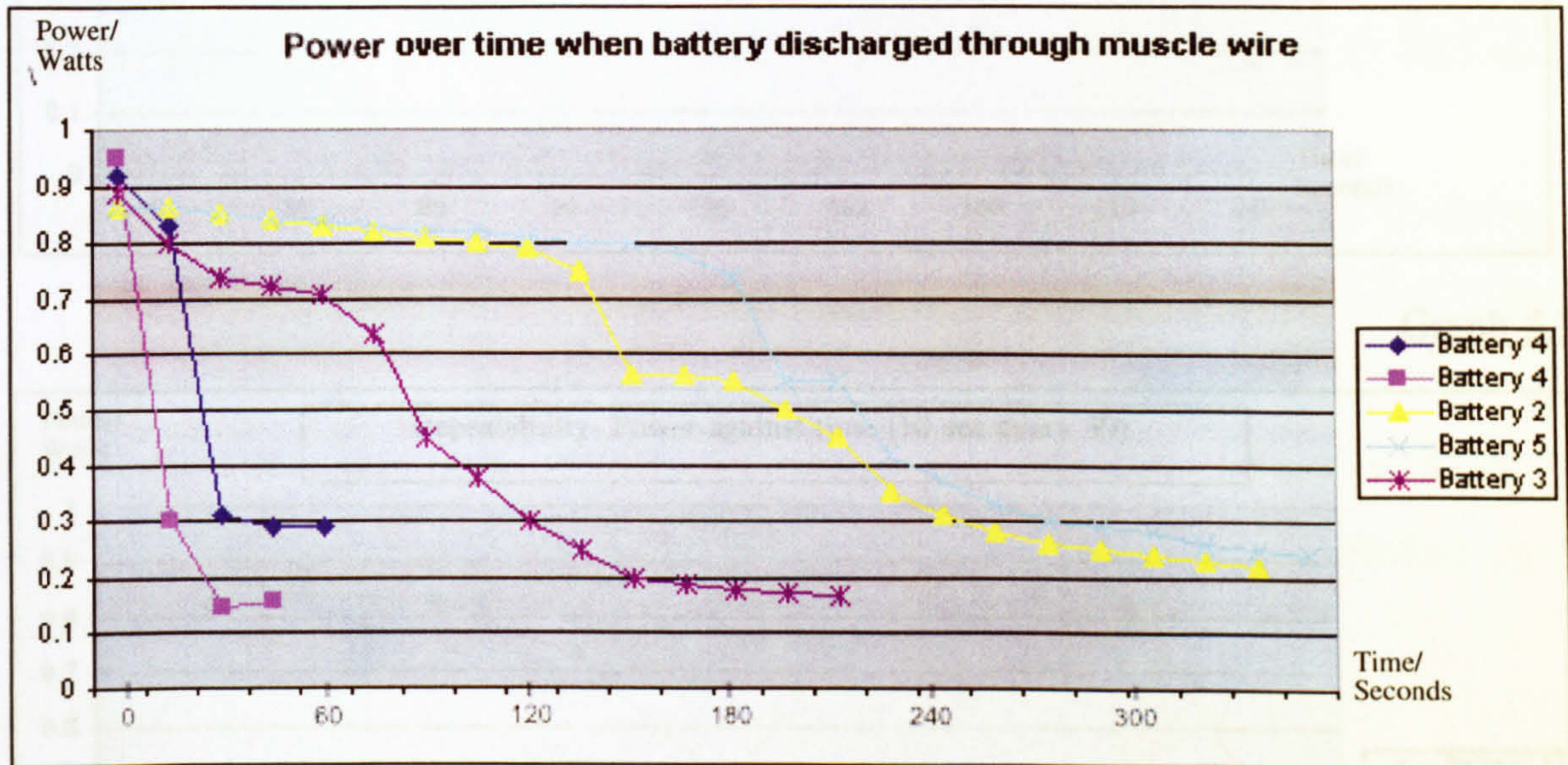

Graph 5.2

Graph 5.2 shows that the batteries are able to always provide *at least* 45 seconds of constant actuation. As the actuated wire is either *contracted*, or *not contracted*, graph 5.2 illustrates time of complete contraction.

Qualitatively, Graphs 5.3 and 5.4 show the results of cyclically triggering the muscle wire. It can be seen that the discharged batteries can repeatedly trigger a muscle wire to maximum contraction, at least four times.

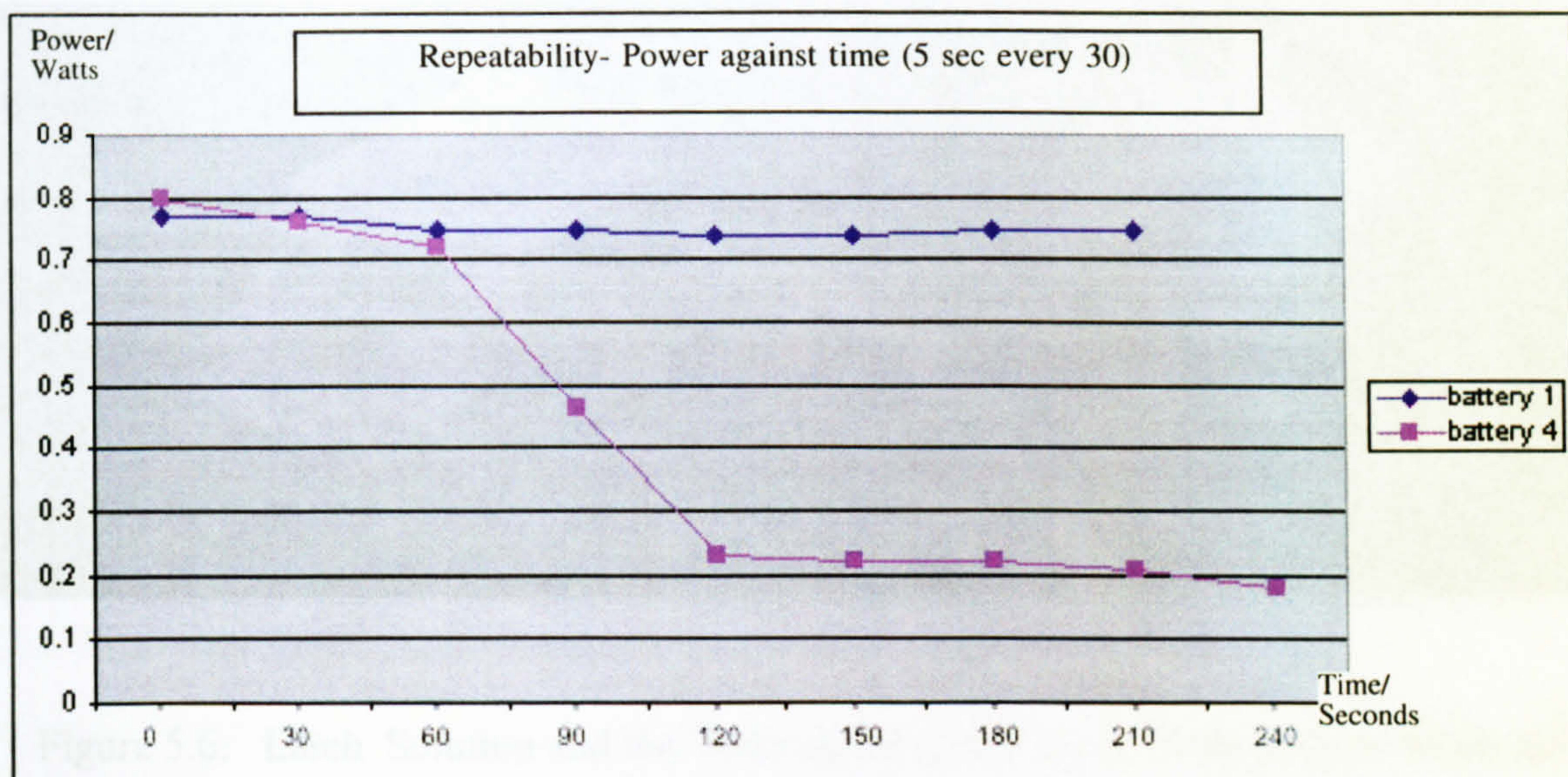

Graph 5.3

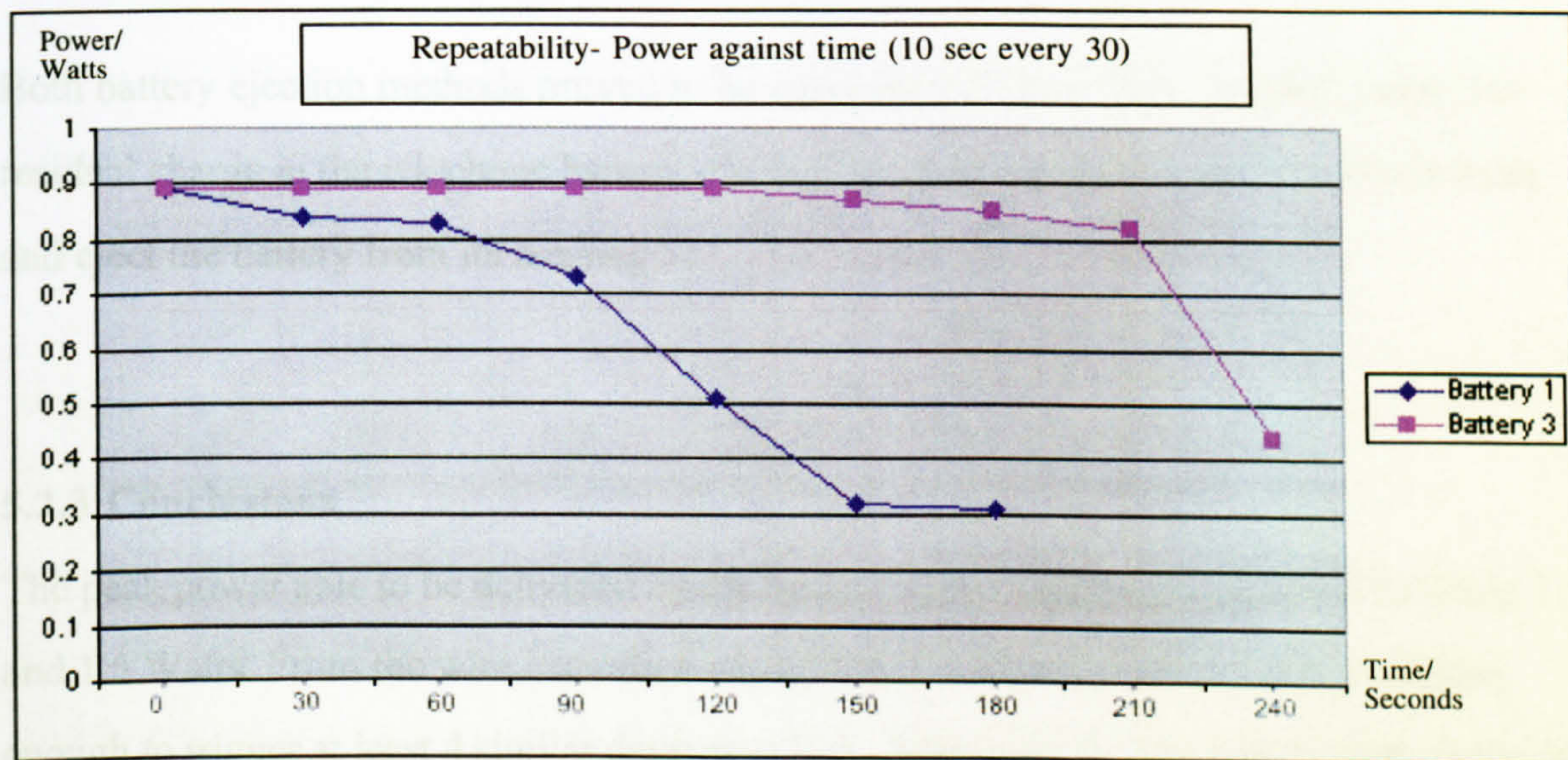

Graph 5.4

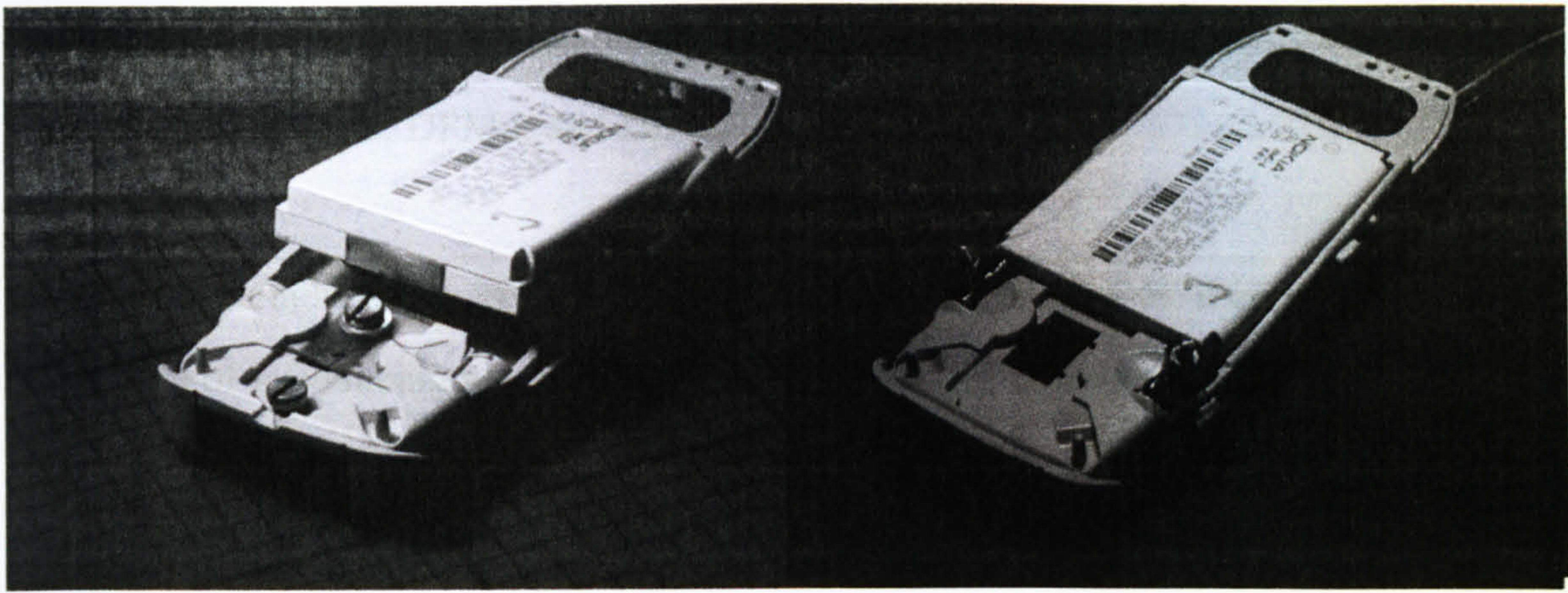

5.2.4 Further Work, and Levels of Innovation

Figure 5.6. Latch Solution and the 'Articulated Arms' Eject Their Battery When the Wire is Triggered.

Both battery ejection methods proved to be successful (*Figure 5.6*). In both cases, the residual charge in the telephone battery was sufficient to trigger the actuator mechanism and eject the battery from its housing.

5.2.3 Conclusions

The peak power able to be delivered by the batteries after discharging them is between 1.1 and 1.5 Watts. From the wire activation experiments we have seen that this would be enough to trigger at least 4 similar devices at EoL. Alternatively, there is enough energy to reliably provide at least 45 seconds of continuous actuation. This can be verified mathematically. By integrating the area under the power/ time curve we can see that the dead batteries are able to deliver at least 42.8 joules of energy to a muscle wire.

The designs of the ejection mechanisms were satisfactory and successful, although a product redesign would be necessary to allow integration and optimisation of these solutions. These design solutions will not retrofit. Incorporation of such solutions will

need to be considered at the design stage, together with necessary considerations with regards to DFA, DfD, DFMo, and DfE.

As there is enough energy in the battery to trigger multiple devices, there is the possibility of introducing hierarchical disassembly of the telephone to allow piece by piece dismantling of the product⁶.

5.2.4 Further Work, and Levels of Innovation

These results show the potential for using residual charge in a battery-powered product to provide energy for self-disassembly. In a design for recycling context, self-disassembly of bulk quantities of products would provide a valuable reduction in manpower and remove a bottleneck in the recycling process. The technology could be used effectively in conjunction with the disassembly of the complete telephone, in a 'disassembly for recycling' context.

There is the potential with this technology for making further innovative design steps. With the actuation mechanism being electrically triggered, there is the potential for activating actuator devices within the product through the keypad. Technical staff at repair/reprocessing centres may use the keypad interface to trigger 'active' devices to enable disassembly or removal of any subassemblies for servicing, repair, or refurbishment.

During hierarchical disassembly, separating the telephone fascia, the screen, then the printed wiring board and the battery would produce four separate waste streams for reprocessing. This method also provides a simple solution for disassembly of the telephones where the battery is effectively 'trapped' inside the telephone, for example, the Nokia 8210.

The falling cost of NiTi in recent years makes using these devices more feasible than in the past. However there is a need to assess the economic consequence of the incorporation of this technology as opposed to other more traditional disassembly methods.

5.3 AUTOMOTIVE APPLICATIONS

Following on from these experiments, a second energy assessment was completed to evaluate the residual energy in End of Life Vehicle (ELV) batteries. Similar to the telephone scenario, it was hypothesised that when a car battery will no longer turn a starter motor, or power 120 watts of Halogen headlamp, it does not necessarily mean that there is no longer any useful energy left in the battery. There *could* still be a large amount of residual energy remaining. An evaluation was completed of the energy contained within an EoL vehicle battery to see if it could be usefully harnessed.

As electrical fastening solutions could be triggered remotely via an electrical circuit, this could allow the disassembly of parts where direct heating would be awkward. An example of such a part would be the instrument panel (IP). The IP attachment fasteners are typically hidden to create an aesthetically pleasing fascia and to provide a surface free from protrusions in the event of a collision.

5.3.1 Experimental Method

An evaluation of 30 EoL vehicle batteries was undertaken to establish residual energy content.

Thirty ELV batteries were obtained from an automotive scrap-yard*. There was no specific selection process for the batteries. The batteries were collected; some in a visually good state of repair and some that were showing bad signs of damage and leaking. As these batteries represented a typical cross section of vehicles at end of life, all of the

batteries were used and none discarded. The batteries had been standing in the scrap-yard for an unknown period of time, and were tested over the course of one month.

**A license exemption was also obtained from the Environment Agency to handle what is regarded as Hazardous Waste.*

A 9V PP3 (*Duracell MX 1604*) battery was discharged through a 150-Ohm resistor (actually measured at 148.7-Ohms) to act as a control experiment. This gave an acceptable power dissipation of 0.624 Watts with the initial starting voltage of 9.63 Volts. This acted as the control experiment, and the discharge curve for the battery was consistent with the manufacturers specification⁸⁹.

Each vehicle battery was connected in series and discharged through the same 20Watt 148.7 Ohm resistor. All tests were completed in a lab temperature between 19 and 23 degrees Celsius. The Voltage against time was plotted using a chart recorder; and battery power was derived from the voltage axis

$$\text{As power: } W = VI = I^2R = V^2/R$$

$$\text{Energy: } \text{Power x Time} = V^2R^{-1}t$$

Therefore, by squaring the voltage axis, and reading the time in seconds, deriving the area under the curve will give indicate the energy contained in the battery in *Joules*, once the area figure is divided by the *resistance* (148.7 Ω).

The same experimental equipment was used for all the tests.

5.3.2 Results

The 9v PP3 battery provided significant energy for nearly 13 hours, at which point the Voltage suddenly dropped from $\approx 4.5V$ to $\approx 0.5V$. The battery was no longer able to deliver any current after 18hours. This was consistent with the Duracell technical data⁸⁹.

When compared to a large automotive load (i.e. headlamp etc), the energy required to drive a shape memory device is comparatively low. This therefore meant that the batteries were discharging for several weeks before any changes in the batteries ability to deliver any current was noticed. It was therefore decided to simply test the behaviour of each battery over a 24-hour period. The area under the curve was integrated using the *Simpson Method*⁸⁸. The limits for the integral were between 0 seconds, and 86400 seconds (24 hours). This resulting figure was divided by 148.7 to calculate the total residual energy. NB: The figure is entered in the table overleaf as an area (mm^2), representing the area under the V^2 / time curve.

In a worst case scenario (battery no.5) the energy contained within the EoL vehicle battery was approximately 65 Joules. This battery was still just able to trigger a small shape memory muscle wire at the end of its 24hr period. This result shows that even in the worst case scenario, a severely discharged and leaking battery with a terminal voltage starting at 1.79 volts, falling to 0.17 volts, contained 65 Joules of useful energy. The full table of results for the energy content of each of the batteries assessed is illustrated in table 5.1 overleaf:

Battery Number	Ambient Temp./ °c	Starting Voltage/ V	Final Voltage/ V	Area under time/ V ² Curve/ mm ²	Area divided by R (148.7)/ Joules	Comments
Control PP3	27	9.61	0.52			
1	23	4.78	4.1	1713242	11521	
2	24	11.10	9.04	8853045	59536	
2	24	7.12	7.26	22531286	151522	
4	27	9.61	8.78	7319829	49225	
5	22	1.79	0.17	9635	65	Low current delivery ≈5A max
6	21	8.01	8.13	5627102	37842	
7	21	6.01	5.87	3048926	20504	
8	20	10.48	9.00	8243873	55440	
9	20	3.41	3.30	972782	6252	
10	20	7.45	7.39	4756950	31990	
11	19	6.55	6.61	3740887	2157	
12	20	4.21	4.22	1535004	10323	
13	20	2.39	2.39	493525	3319	Severe acid leaks
14	20	8.16	8.35	5888509	39600	
15	19	6.14	6.17	3273199	22012	
16	19	6.59	6.26	3568998	24001	
17	20	9.34	9.04	7298951	49085	
18	18	3.49	3.39	1022639	6877	
19	20	1.47	1.39	176818	1189	
20	19	7.86	8.00	5433679	36541	
21	18	6.16	5.78	3082492	20730	
22	20	3.45	3.22	962102	6470	
23	20	3.92	3.96	1341274	9020	
24	20	7.78	7.96	5352048	35992	
25	19	4.87	4.99	2100254	14124	
26	19	8.52	8.78	6466124	43484	
27	20	6.71	6.61	3832539	25774	
28	20	7.00	7.04	4257861	28634	
29	20	5.78	5.74	2866579	19278	
30	19	6.13	6.26	3316226	22301	

Table 5.1 Evaluation of the Energy Contained in 30 Randomly Selected ELV Batteries

5.3.3 Conclusions

The discharge curve of the batteries was as expected, the discharge rate remained very linear⁹⁰. The control battery also discharged consistently with the published data sheets.

The battery didn't contain as much energy as was expected; the energy content not being significantly more than an EoL telephone battery.

From the results we could see that for all of the 30 batteries there is more than enough energy to trigger shape memory devices similar to those used in the mobile telephone.

There is more energy available in the waste automotive batteries, therefore from table 5.2 we can see that more active devices could be used.

The least healthy of the batteries tested contained 65 Joules of energy, and it is based on this battery that the information below was calculated. As the table has been compiled for use in designing automotive systems for disassembly, a triggering time of 5 seconds has been used, where only one second was needed to disassemble the EoL telephones. This is due to the fact that larger automotive components (such as instrument panels) will require more manhandling due to their bulky nature, thus requiring the devices to be actuated for longer.

SMA Wire Diameter/ microns	Resistance/ Ohms m ⁻¹	Current Drawn at 12V (100mm wire length)/ Amps	Energy consumption/ Joules sec ⁻¹	Energy needed for 5 seconds of triggering/ J	Minimum number of devices able to be triggered at EoL/ <i>Whole No's.</i>
25	1770	0.068	0.818	4.09	16
37	860	0.140	1.686	8.43	8
50	510	0.235	2.816	14.08	4
100	150	0.800	9.600	48.00	1
150	50	2.400	28.800	144.00	0
250	20	6.000	72.000	360.00	0
300	13	9.230	110.769	553.85	0
375	8	15.000	180.000	900	0

Table 5.2 Tabulated Information on the Number of Shape Memory Wires that can be Triggered at EoL

It must be pointed out that the worst battery in the assessment (battery 5) provides the information above in theory only. The battery was in such a poor condition that it was unable to deliver the current required for the larger (250 micron and up) wires. The

maximum current able to be delivered was in the region of 5 amps. The battery could trigger the larger 150-micron wire, but not for 5 seconds. The rest of the sample population were able to trigger any of the other wires.

The information presented in Table 5.2 provides a very useful design tool to aid the incorporation of ADSM technology into battery powered devices. This table can be used in conjunction with other DfD and DfE methodologies to create EcoProducts that are simpler to recycle than previous product generations.

It was also noticed from the results, for a few batteries the potential difference measured at the terminals actually increased during the test cycle. It is well known that the working voltage of a practical cell under load can rise with an increase in temperature. This is due to the drop in internal resistance of the cell caused by increased conductivity of the electrolyte phase⁹¹. However, given the amount of energy contained within the batteries, this small rise is comparatively negligible.

5.4 FURTHER ELECTRICAL DEVELOPMENT.

5.4.1 Electrically Heated SMA Fasteners

Electrically activated active disassembly devices are not limited to muscle wires. Other shape memory fasteners and actuators that have been previously thermally activated could be triggered electrically if a small heating element or coil is built into the fastener (*Figure 5.7*).

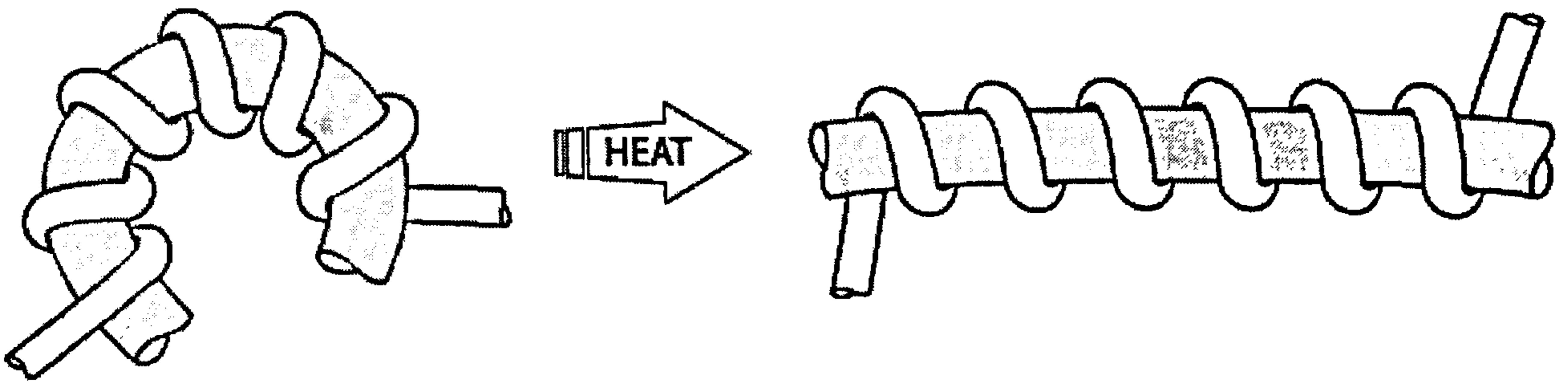

Figure 5.7 Electrically Heated SMA Clip

Utilising the residual energy in the waste automotive batteries, prototype clips triggered by electrically heated NiChrome wire were produced. A PTFE coated wire was found to be the most suitable as it was able to withstand higher temperatures (up to 240°C) than conventional shellac coated wires. However, PTFE coated NiChrome wire is somewhat springy, so the wire element needs to be taped or glued to the clip to keep the wire coils tight. An additional Ni-Chrome heating element was used to heat the clips, as a direct connection to the SMA with this cross section will draw over 100 Amps at 12 Volts.

To keep the clips robust, larger sections of SMA rod (~2mm) are used instead of the SMA muscle wires. The experimental clips, as used on the EcoCar IP (Section 4.4), were based around 2mm NiTi rod, wrapped with PTFE coated 34swg NiChrome wire. This gave an effective clip cross section of 0.72mm in diameter. When wrapped with 0.05m of wire, with a resistance $24.7\Omega\text{m}^{-1}$, the overall electrical resistance of the clip was 1.25Ω .

However, due to the thermal conduction needed to trigger these clips, they did take twice as long as the 'plain' muscle wires (10 seconds was allowed for actuation rather than 5).

See calculation overleaf:

A clip of resistance 1.25Ω , is triggered with 12V

$$\therefore 12/1.25 = 9.6A$$

$$\text{Power} = I^2R$$

$$\begin{aligned}\therefore \text{Power} &= 9.6^2 \times 1.25 \\ &= 1152W\end{aligned}$$

For 10 seconds actuation, the energy required is therefore 10×1152 or 11520 Joules

None of these devices are able to be triggered by the 65 joules remaining in battery 5 as the energy content is too low, and the very poor condition batteries are unable to deliver over 5 amps. These electrically heated clips will have to be integrated into assemblies that are disassembled either when the vehicle is still running or complete (i.e. servicing issues), or disassembly would have to be externally powered at EoL.

The NiChrome wire 'tails' effectively become flying leads that can be integrated into any electrical circuit or attached to a connector. They can also be attached to larger diameter wires for incorporation into a vehicle wiring loom (figure 5.8). The NiChrome tails need to be kept as short as possible to lower the resistance of the device, and maximise current flow.

The larger the cross section of this type of SMA clip means it has greater mechanical strength. This can be utilised either to apply force, or as a retention device. The fact that the actual 'active' SMA component is not being utilised as a muscle wire also means that the device doesn't have to be kept under tension to eliminate slack.

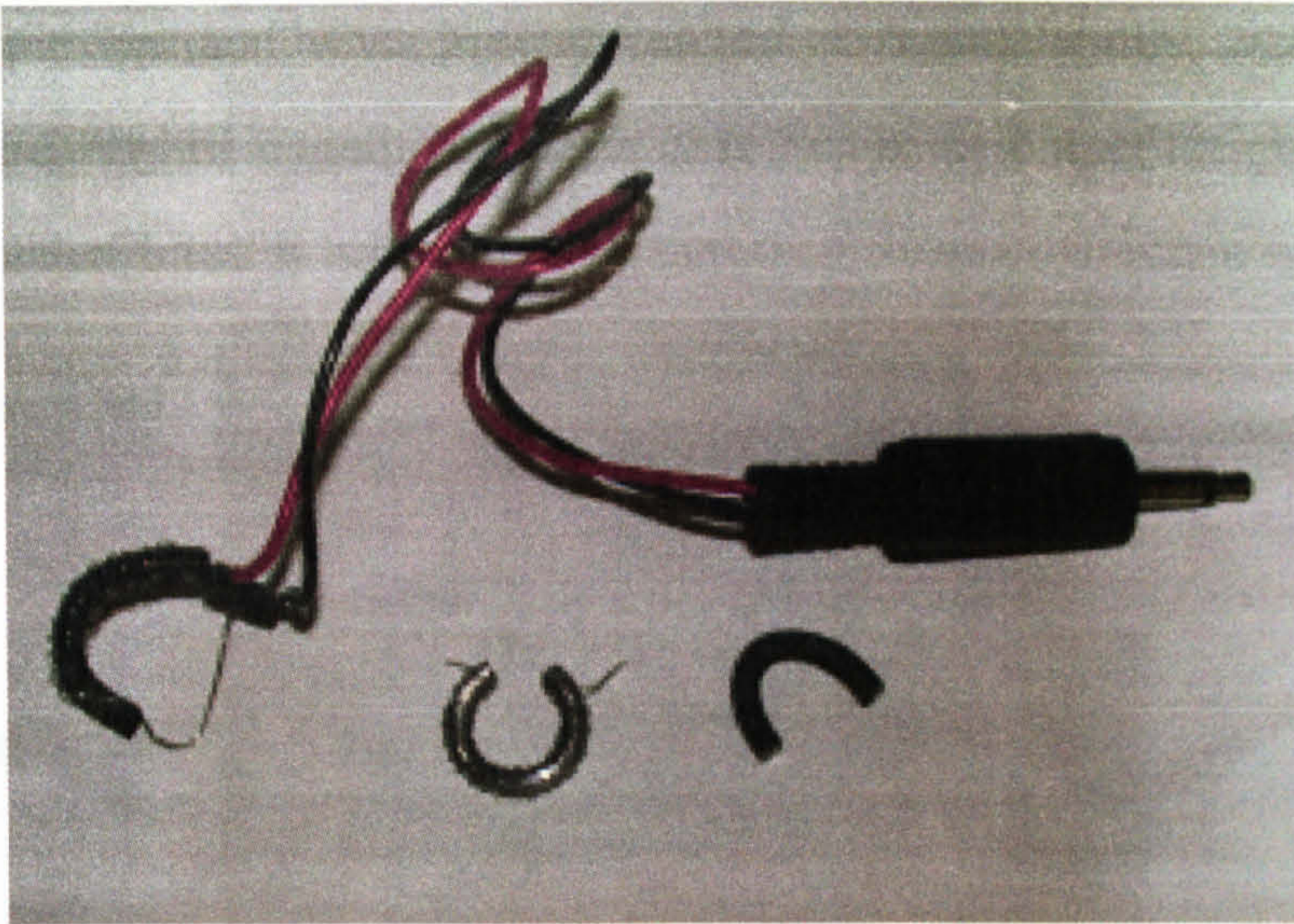

Figure 5.8 Electrically heated and unwound circlip, next to an un-triggered clip

5.4.2 Electrically Heated SMP Fasteners

In addition to the electrical triggering of SMA wire clips with an external heating element, experimentation was undertaken to assess the feasibility of swiftly electrically triggering an SMP snap-fit by direct electrical heating. A further optimised system was also created, to evaluate if radiant heat loss from the heating element could be minimised by embedding the heating element inside the clip.

5.4.2.1 Experimental Method

SMP snap-fit fixtures have already been proved to retain integrity over many cycles (Section 2.4.9.3). Four differing clip designs were tested for electrical triggering and their energy consumption was evaluated.

- 1) An existing SMP snap-fit device was retrofitted with a PTFE coated Ni-Chrome heating element by wrapping a 136 mm length of around the clip (see fig 5.9). The clip design was of an identical design to that in figure 2.5. The PTFE coated wire was of a resistance of $24.7\Omega\text{m}^{-1}$, and of 34 swg in section, as used in the previous experiments.

The current, voltage (and hence power) required to trigger the clip, together with the triggering time were all logged. Sufficient time for the cooling of the clip has to be allowed before each test is repeated.

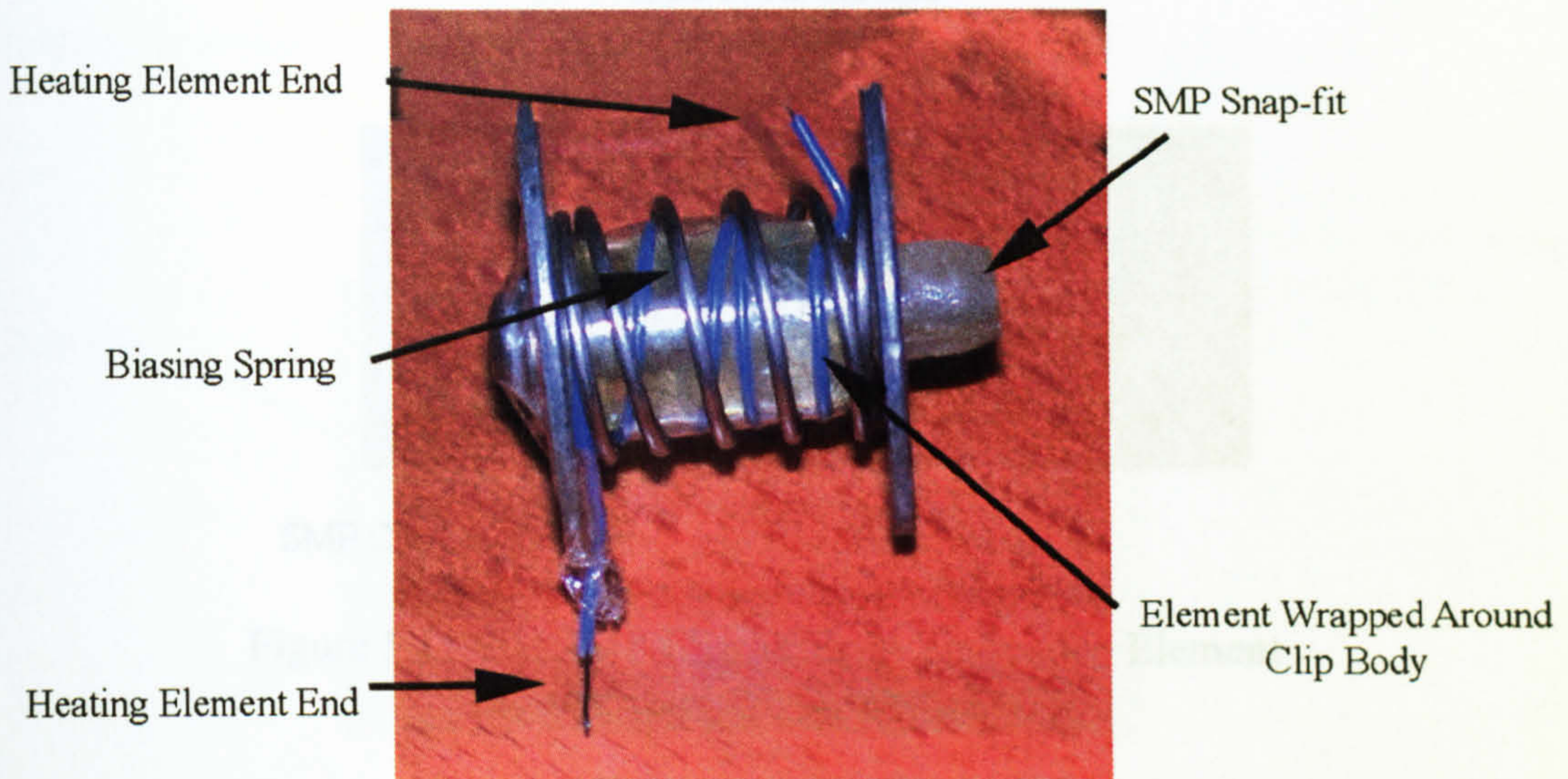

Figure 5.9 Assembled Electrically Triggered SMP Snap-fit

2. A second experiment was then conducted to see if it was possible to optimise the performance of the clip. The snap-fit was drilled with 0.75mm longitudinal holes, and the heating element was embedded inside the clip (see fig 5.10). The experiment was repeated to observe if the performance of the clip was improved.

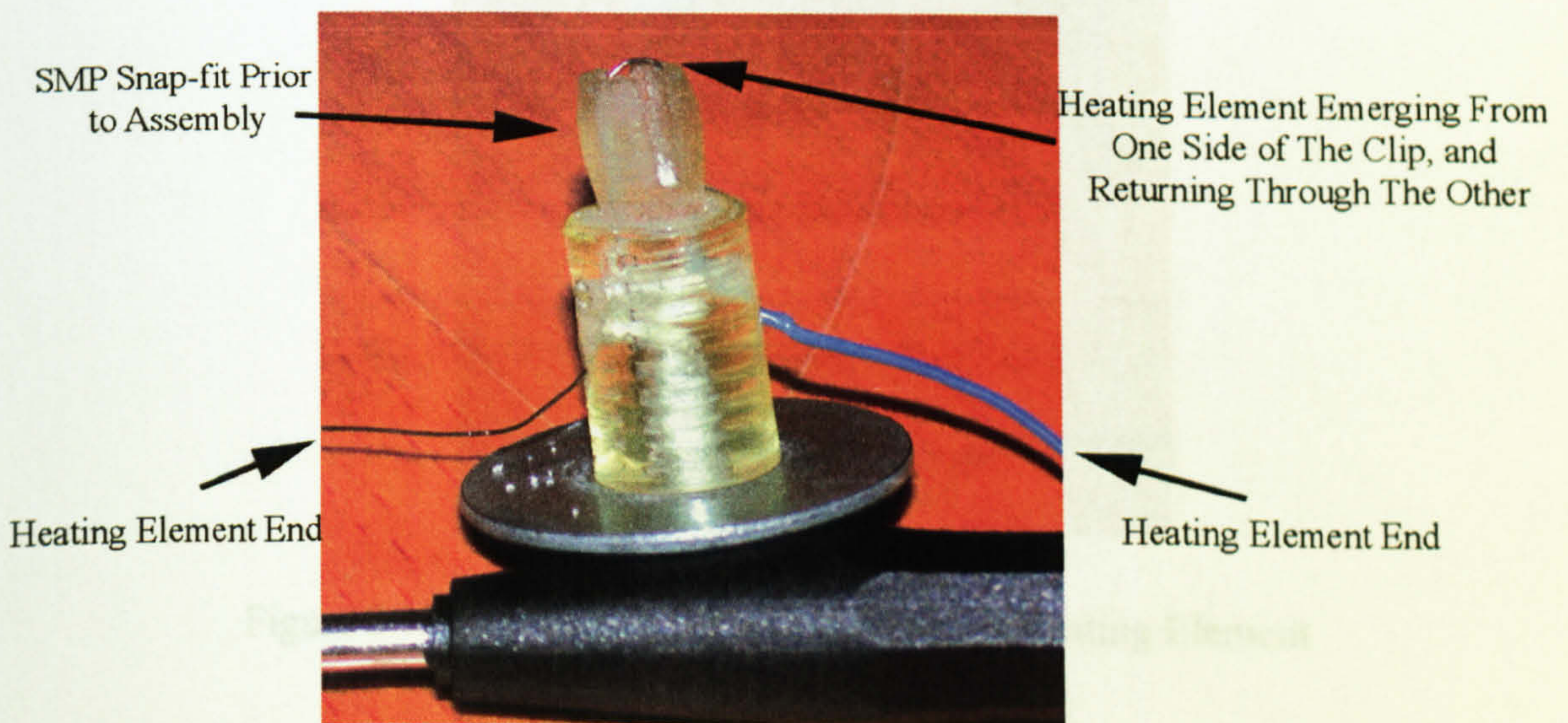

Figure 5.10 Heating Element Embedded In an SMP Snap-fit

3. The heating concept was further investigated by casting a single 187mm long Ni-Chrome heating element into a flat SMP sample (see fig 5.11).

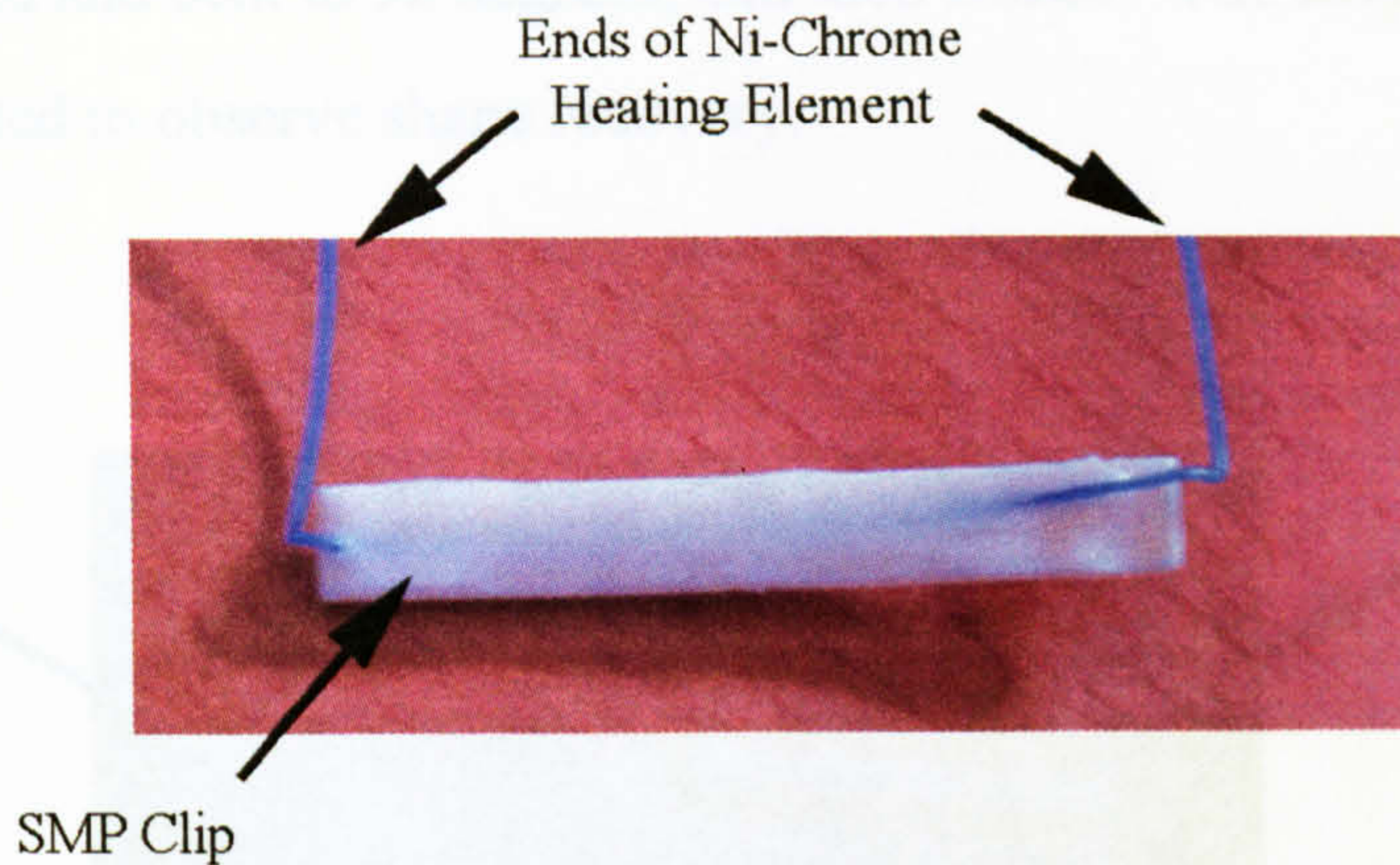

Figure 5.11 Flat SMP Clip With an Embedded Element

The device was then warmed and manipulated into a 90° bend. The sample was then frozen in cold water to lock the shape in place. (see fig 5.12) The section of this clip resembles a standard flat snap-fit as found in many product casings. This flat sample was then electrically connected to a power supply to observe recovery.

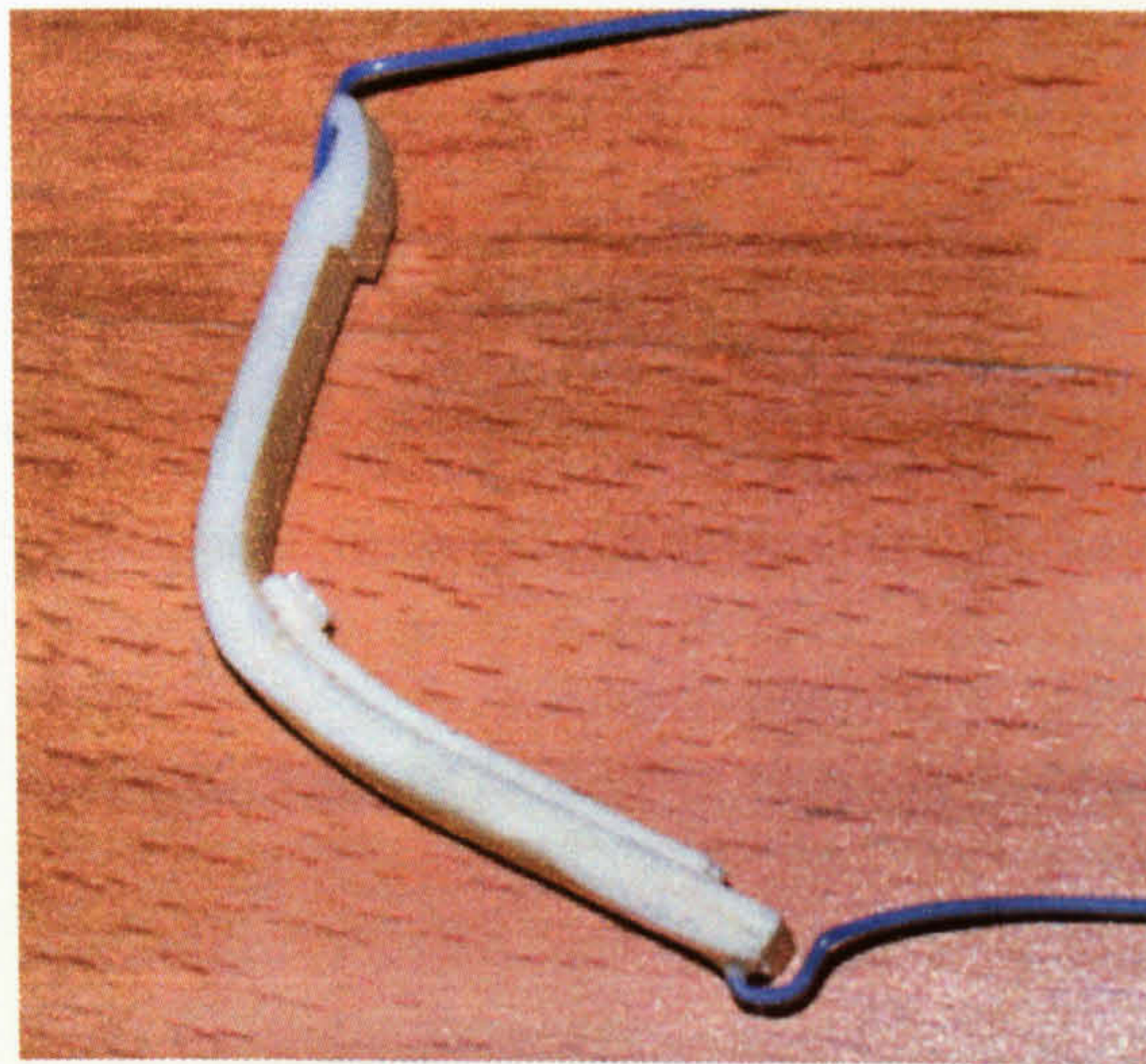

Figure 5.12 Bent SMP Clip with Embedded Heating Element

4. The flat strip experiment was refined by creating a double width flat strip with a doubled-up 209mm Hi-Chrome heating element embedded into it (figure 5.13). This was again heated and bent to 90 degrees, and then frozen. The strip was then electrically heated to observe shape recovery.

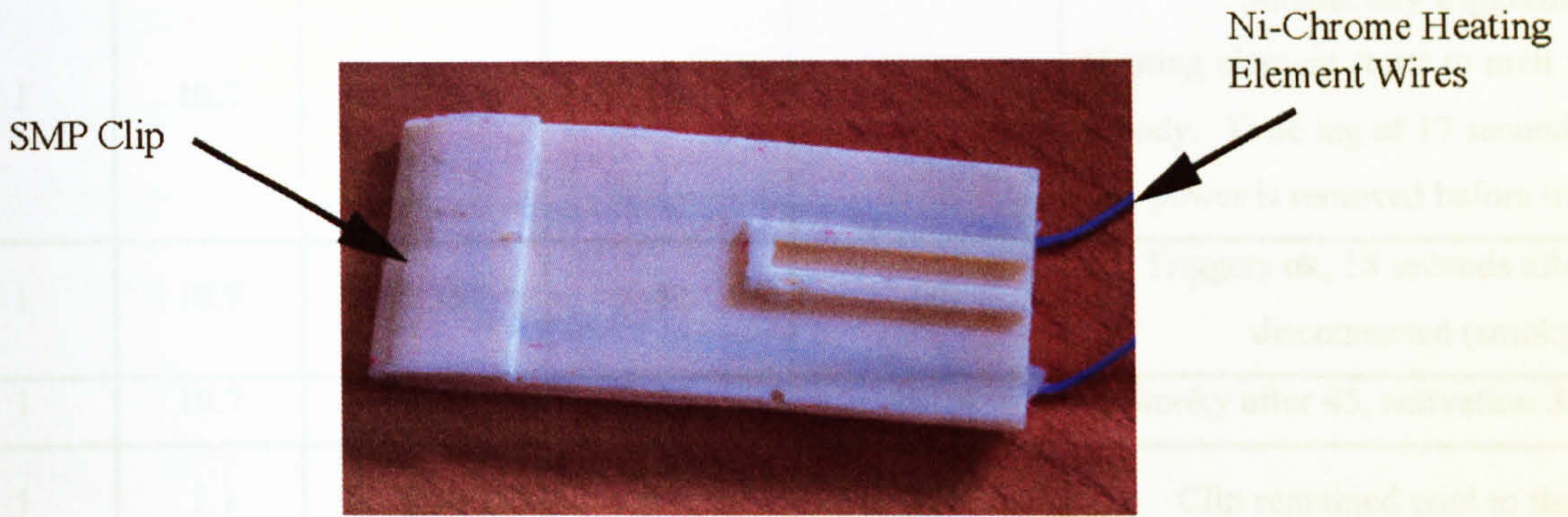

Figure 5.13 Large Flat SMP Clip With a Doubled Heating Element

The Recovery results for all the clips are listed overleaf.

1	10.7	3.26	10	439	Clip remained cool to the touch
1	10.7	3.26	10	439	12V applied as in a cap - activation 30 sec
2	10.7	3.26	15	100.5	Released after 1 sec, crushed 2 seconds after heating stopped
2	10.7	3.26	19	203.3	Released slowly
3	7.8	4.61	90	702	Slowly recovered
3	7.8	4.61	85	663	Slowly recovered
3	7.8	4.61	90	702	Slowly recovered
3	7.8	4.61	92	717.6	Slowly recovered
4	6.96	5.17	240	1670	Shape not recovered
4	27.9	8.17	80	2228	SMP 'swells' around heating element through excess local temperature

Table 5.3 Performance of Electrically Heated SMP Clips

KEY: Device 1- SMP snapfit, external heating element

Device 2- SMP snapfit, embedded heating element

Device 3- Flat SMP strip, 1 embedded element

Device 4- Flat SMP strip with a 'doubled' embedded element

5.4.2.2 Results

Device Type	Power/ W	Element resistance/ Ohms	Time That Power Was Applied Over/ S	Energy Consumed in Activation/ J	Observations
1	10.7	3.36	35	374.5	Satisfactory triggering. Heating element starts to melt into the clip body. Time lag of 17 seconds after the power is removed before triggering
1	10.7	3.36	40	428	Triggers ok, 15 seconds after power disconnected (smoky)
1	10.7	3.36	45	481.4	Smoky after 45, activation 30 sec later
1	1.1	3.36	360, but no activation	396	Clip remained cool to the touch
1	42.9	3.26	10, clip body melted	429	12V applied as in a car- activation 30 sec later
2	10.7	3.26	15	160.5	Juddered after 7sec, released 2 seconds after heating stopped
2	10.7	3.26	8	85.6	Released cleanly
2	10.7	3.26	15	160.5	Juddered after 7 sec
2	10.7	3.26	19	203.3	Released cleanly
3	7.8	4.61	90	702	Slowly recovered
3	7.8	4.61	85	663	Slowly recovered
3	7.8	4.61	90	702	Slowly recovered
3	7.8	4.61	92	717.6	Slowly recovered
4	6.96	5.17	240	1670	Shape not recovered
4	27.9	5.17	80	2228	SMP 'swells' around heating element through excess local temperature

Table 5.3 Performance of Electrically Heated SMP Clips

KEY: Device 1- SMP snapfit, external heating element

Device 2- SMP snapfit, embedded heating element

Device 3- Flat SMP strip, 1 embedded element

Device 4- Flat SMP strip with a 'doubled' embedded element

Mass of SMP:

Clip 1: 1.54g

Clip 2: 1.54g

Clip 3: 1.37g

Clip 4: 5.11g

Solutions 1 and 2 encompassing a biasing spring trigger suddenly, and completely release.

Clip 1 requires approximately 400 Joules of energy to trigger.

Clip 2 requires approximately 160 Joules of energy to trigger.

Clip 3 requires approximately 700 Joules of energy to trigger.

Clip 4 is an unsuccessful design.

5.4.2.3 Conclusions

From the results it can be seen, that SMP clips can be electrically triggered.

- Clip 1 is an unsuitable design for electrical triggering. In all the successful disassembly cases, the power had to be removed from the clip as it overheated and began to melt. Energy is wasted with this design of clip, as heat will be dissipated to the surrounding air. When decreasing the power to the clip to avoid burning, the clip fails to trigger.
- Clip 2 is more than twice as efficient than clip one, proving that the energy applied to the clip is more efficiently utilised. The Biasing spring provides a sudden release of the clip in a short space of time, although still longer than for an SMA clip. This is because although the heating wire is embedded inside the clip, the insertion holes had to be slightly oversized to allow the wire to slide through during assembly. These oversized holes therefore prevented full wire contact.

As a streamlined calculation: The length of wire was kept the same as for clip 1 to keep the resistance (and hence power consumption) the same to allow direct comparisons to be made. This meant that only 20mm of wire was embedded inside

the clip. On a length for length basis, this means that the effective element length in clip 2 is 6.5 times shorter. Given the decrease in activation time, this gives an overall improvement of a factor of 13 over clip 1.

For this solution to be fully developed, a longer length of heating wire will need to be uniformly moulded inside the clip. This does however create an undesirable material mix from a recycling perspective.

- Clip 3 is a larger clip (by mass) and takes longer to heat. The heating element is completely embedded in the clip. The decreased efficiency of this clip can be attributed to the very low force able to be applied by SMPs through shape recovery⁵. The lack of a biasing spring therefore significantly affects the performance of the device.
- Further to the observations of clip 3, the performance of clip 4 confirms these assumptions. There is twice the length of embedded wire inside the clip, and even when enough power is put through the element to expand the SMP material locally, the complete clip fails to recover its shape. As a subjective, qualitative observation, the clip begins to feel soft by touch, but without any external force assistance, the clip retains its bent form. The extra thermal mass (approx. 4 times the mass of clip 3) is too large for the heating element installed

As with previous disassembly solutions developed both in this thesis and in external investigations, the SMP solution proves itself to be the more energy efficient^{7, 9, 65, 79}, at ≈ 160 Joules as opposed to 11520 Joules for an electrically heated SMA clip. A precise figure for the amount of energy required to trigger a clip of a given mass is not possible due to the complex thermomechanical behaviour of SMP. The specific heat capacity for SMP is not a simple figure, but a range of values following a nonlinear relationship with

respect to temperature⁹². This phenomena coupled with the thermal gradients present within the clip due to differing sections means that the energy required to trigger each clip design will be unique and again best suited to CFD analysis.

The energy evaluation figures quoted for both SMA and SMP clips are not however a direct comparison of clip performance. A SMA clip will still be far stronger than an SMP fastener, and will be suitable for use in environments outside the satisfactory operating range of an SMP clip. If the clips are intended to be used in a scenario where they provide *retention only* for a part which itself carries all structural load, then electrically triggered SMP fasteners can provide an energy efficient disassembly solution.

The ageing of SMP samples has not been considered or evaluated, as the time frame required to evaluate polymer degradation is beyond the scope of this study. However, SMP samples have been put into storage for possible further investigation in several years time.

5.4.2.4 Further Active Concepts

By utilising the electrically triggered clips developed within this section, the possibility of creating an electrically released instrument panel could be a real possibility. By eliminating the necessary passageways or ports required for thermal circulation or hot probe insertion, assemblies designed for electrical assembly can be visually very similar to panels fitted to existing vehicles. An electrically removed IP could insert into a vehicle as a complete unit and simply snap-fit in place. The vehicular location point can bear the structural load (*i.e. the IP mounts onto ribs or rails on the monocoque*) and the Active SMP fixtures provide positive retention *only*.

5.5 COMPARING MANUAL DISASSEMBLY WITH ELECTRICAL DISASSEMBLY OF AN INSTRUMENT PANEL USING THE DOWIE DfD METHODOLOGY

5.5.1 Introduction

To evaluate the effectiveness of the proposed electrically triggered smart material clips, a comparison of ‘smart material disassembly’ versus ‘conventional disassembly’ was made using a ‘streamlined’ version of the *Dowie* DfD methodology⁵⁷. The time to complete each disassembly operation is based upon the times calculated by *Dowie* in the construction of the DfD methodology itself. The full *Dowie* ‘spreadsheet’ methodology aims to “generate a disassembly sequence from the information regarding the precedence, the disassembly cost and the recycling revenue of each part or subassembly”. Whilst the additional indexes of cost etc are all valid points from an economic DfE perspective, in this instance, ‘streamlining’ the methodology by looking at disassembly operation times *only* allows a comparison of disassembly time savings to be evaluated, outside of any other factors.

5.5.2 Methodology Applied to an Automotive Instrument Panel

The *Dowie* DfD methodology was applied to a 1994 MKII Ford Fiesta XR2 instrument panel. This model was assessed as it contains the full compliment of additional switches for heated screens, electric windows and fog lamps, therefore representing a ‘worst case’, or ‘longest disassembly time’ scenario.

The table overleaf illustrates the manual disassembly time for the instrument panel. All screws have been calculated as being manually removed due to difficult access with a power tool. Self tapping screws are of a 4mm shank diameter and typically use 13mm of 1.3mm pitch thread, therefore taking 10 revolutions to remove. At 0.6 seconds per revolution⁵⁴ to remove, each self-tapping screw will take 6 seconds to remove.

Process Number	Description	Operation	Time/ Sec
1	Disconnect Battery	Pick up tool	0.7
		Loosen M6 terminal 4 rev's	2.4
		Put down tool	0.7
		Remove clamp	0.5
2	Steering column shroud remv'l	Pick up tool	0.7
		Remove 2 self-tapping screws	12.0
		Remove shroud upper	0.5
		Remove 4 self-tapping screws	24.0
		Put down tool	0.7
3	Steering wheel/ Airbag removal	Orientate wheel	0.3
		Insert key	0.5
		Pick up tool	0.7
		Undo screw M5x20	15.0
		Orientate wheel	0.3
		Undo screw M5x20	15.0
		Put down tool	0.7
		Lift bag unit	2.0
		Disconnect trigger wire	1.5
		Remove bag	2.0
		Pick up tool	0.7
		Cut wiring clip	0.25
		Put down tool	0.7
		Orientate wheel	0.3
		Remove Key	0.5
		Pick up tool	0.7

		Undo s/wheel bolt M10 x20	8.0
		Put down tool	0.7
		Pull off wheel	2.0
4	Remove Instrument Bezel	Pick up tool	0.7
		Remove 2 self-tapping screws	12.0
		Put down tool	0.7
		Lift off bezel	0.3
5	Remove multi-functional switch	Disconnect wiring	1.5
		Pick up tool	0.7
		Remove M5x6 screw	4.5
		Put down tool	0.7
		Remove switch	0.5
6	Disconnecting ignition loom	Disconnect plug	1.5
		Pick up tool	0.7
		Cut cable tie	0.25
		Put down tool	0.7
7	Disconnect brake light	Remove connector	1.5
8	Disconnect speedo cable	Unscrew cable 10x1.0,x 10 (fine)	6.0
9	Remove instrument cluster	Pick up tool	0.7
		Remove 4 screws	24.0
		Put down tool	0.7
		Disconnect multi-plug	1.5
		Fully remove cluster	1.5
10	Remove radio	Pick up tool	0.7
		Remove 4 M3 grub screws	24.0
		Put down tool	0.7

		Pick up tool	0.7
		Remove radio	2.0
		Disconnect loom	1.5
		Disconnect arial	1.5
		Fully remove radio	2.0
11	Removing centre console	Pick up tool	0.7
		Remove 4 snap switches	12.0
		Put down tool	0.7
		Unscrew gear knob 8mmx20	9.6
		Remove gaiter	1.0
		Pick up tool	0.7
		Remove 4 self-tapping screws	24.0
		Put down tool	0.7
12	Removing fascia ancillaries	Pull off fan knob (snap)	1.5
		Move 2 air distributors	0.6
		Remove 2 heater knobs	3.0
		Unclip heater trim	1.0
		Disconnect bulb holder	1.5
13	Remove ashtray	Unclip ashtray	1.0
		Pick up tool	0.7
		Remove 3 self-tapping screws	18.0
		Put down tool	0.7
		Disconnect Cigarette lighter	1.5
14	Remove fan control	Disconnect fan switch	1.5
		Pick up tool	0.7
		Remove 3 self-tapping screws	18.0

		Put down tool	0.7
15	Switch removal	Pick up tool	0.7
		Prise out 4 switches	12.0
		Put down tool	0.7
		Remove 4 wiring plugs	6.0
16	Clock removal	Pick up tool	0.7
		Prise out 4 clock	3.0
		Put down tool	0.7
17	Fuse box removal	Remove lid	1.5
		Pick up tool	0.7
		Remove 2 self-tapping screws	12.0
		Put down tool	0.7
18	Remove wiring	Pick up tool	0.7
		Unscrew earth M5x6	4.5
		Put down tool	0.7
		Pick up tool	0.7
		Cut 3 cable ties	0.75
		Put down tool	0.7
		Open door (x2)	3.0
		Disconnect A-pillar wiring (x2)	3.0
		Detach weather strips (x2)	2.0
		Pick up tool	0.7
		Disconnect (x2)	3.0
		Unscrew 4 self-t'ping sill-plates	24.0
		Disconnect (x2)	3.0
		Put down tool	0.7

		Pick up tool	0.7
		Cut 4 cable ties	1.0
		Put down tool	0.7
		Pick up tool	0.7
		Remove air-vent	3.0
		Disconnect wiring (x2)	3.0
		Put down tool	0.7
19	Fascia removal	Pick up tool	0.7
		Prise out screw covers	6.0
		Put down tool	0.7
		Pick up tool	0.7
		Remove 7 self-tapping screws	42.0
		Put down tool	0.7
		Lift fascia	2.5
		Pick up tool	0.7
		Cut 10 cable ties	2.5
		Put down tool	0.7
		Completely remove fascia	2.5
		TOTAL	443.25

Table 5.4 Disassembly Time for a Ford Fiesta MKIII Instrument Panel

5.5.3 Disassembly Improvements from the Application of Electrically Triggered ADSM

By incorporating technology already developed in this study, it would be possible to replace all the self-tapping screws in the fascia assembly with active clips. All these

fixtures could then be released simultaneously when disassembly is required. The airbag fixture can also be replaced with the active airbag fixture developed in Chapter 4.2

Leaving the machine screw fixtures in place (battery, radio, ignition wiring etc,) a revised disassembly time would be as listed below:

Process No.	Operation	Time/Sec
	Time carried over:	<u>443.25</u>
	Subtract self tapping screw total removal time	210.0
	Subtract associated tool pick-up/ put-down time	12.6
3	Subtract steering wheel/ airbag separation time	44.4
	Add: Pick up electrical triggering tool	0.7
	Deploy electrical devices	10.0
	Put down electrical triggering tool	0.7
	Pick up Air-bag freeze trigger	0.7
	Deploy freeze trigger	10
	Put down freeze trigger	0.7
	Revised Total	199.05

Table 5.5 Revised Disassembly time for an Active 'IP'

The results from disassembling the instrument panel and making a theoretical time comparison shows that Electrical ADSM can lead to a time saving of 244.2 seconds, or a percentage time saving of 55%.

5.5.4 Conclusions Drawn from The Application of the Streamlined Dfd

Methodology

Based on this evaluation, time savings of the order of 50 % can be made in the disassembly of a vehicle instrument panel by incorporating ADSM technology. The fact that large numbers of fasteners can be disassembled simultaneously, and tool changes can be eliminated leads to large overall time savings.

However, the initial disassembly time of 443.25 seconds is itself may not be strictly accurate in this instance. Disassembling a large vehicle structure such as an IP in a practical 'workshop' environment can not be directly compared with a 'bench' or 'disassembly line' scenario. According to the glass's Guide, the instrument panel should be taking in the order of half an hour to remove⁷⁸ (1800 seconds). The initial methodology calculation therefore differs by approximately 75%. The extra time required can be explained by the time needed by a technician to manoeuvre around the vehicle and position their tools into difficult to reach areas. This extra time needs to be evaluated and built into the methodology initially. This observation aside, by using the *same* methodology on two slightly differing assemblies, *does* provide a means of quantitatively comparing the efficiency of new disassembly methods and the application of new materials.

Also, the Glasses ICME manual is a time guide created for vehicle repair centres so they are able to profitably quote for repair tasks to the customer. This time estimation also has to take into account a worst case scenario (situation with seized or sheared screws that require drilling, crash buckled parts etc.), and is also therefore initially an overestimation.

5.6 ELV APPLICATIONS

In an automotive context, the work in the previous sections proves the possibility and viability of using the residual charge in the car battery of an ELV for powering the disassembly of the host vehicle. In this scenario, active disassembly can be achieved when the vehicle is being depolluted. In accordance with the ELV legislation, all vehicles will be depolluted at their end of life. In this scenario, there is a window of around 20 minutes when the vehicle is on the ramps at the depollution station being drained of fluids. It is at this point that the shape memory devices could be triggered. Once the devices have been triggered and the appropriate parts have been removed from the car, the battery can be removed from the car and recycled or reused.

Active disassembly of multiple assemblies can be simultaneously triggered, allowing the removal of multiple parts. Also, due to the time decrease associated with actively removing parts such as the IP, parts previously requiring in the order of 30 mins to remove are now able to be removed within the 20 minute 'depollution window'.

Where previously the triggering of ADSM devices has been difficult (particularly for a large product such as a complete vehicle), electrical triggering has the potential to overcome heat distribution problems, and to allow simple simultaneous triggering.

Further hypotheses as to how to maximise the benefits of electrically powered ADSM are detailed in Chapter 7.

Chapter 6

Discussion

6.1 INTRODUCTION

The work represented in this study is unique for several reasons. These reasons are discussed in this chapter contextually with regards to existing work in the field. The industry reaction to this study is also considered, and summarised to prove or disprove the validity of this research area for further work.

6.2 AUTOMOTIVE ADSM PLACED INTO THE CONTEXT OF EXISTING WORK

6.2.1 Retrospective Comparison with the Work of *Gupta et al.*

The proposed automotive ADSM solutions presented in this study represents generic releasable fastening solutions that can be used in a wide variety of contexts and triggered at generic vehicle depollution stations. Previous attempts at producing disassembly lines by researchers such as *Gupta et al*^{96,97} have been product specific. Although they have been successful in achieving high percentage disassembly of products such as IBM computers, the disassembly 'infrastructure' does not accommodate product variants. By redesigning the products initially around electrically triggered shape-memory fastening solutions, disassembly ultimately becomes simpler and easier to achieve. *Gupta's* disassembly lines- although based around DFA products, are essentially 'retrospectively'

disassembled. By applying ADSM philosophy to the initial product design- total DfD and green design can be easier to achieve.

6.2.2 Further Evolution of the Brunel University Toolkit

The work presented in this study has been very much an evolution of the initial work at Brunel University by Billett, Chiodo *et al*^{5,6,7,65}, and the further work undertaken with the EU Framework V ADSM Project. The further disassembly solutions developed for Automotive ADSM are very much complementary to the solutions proposed for small electronic products, although they are essentially 'different tools for a different job', they have added to the overall ADSM toolkit in development at Brunel. Where satisfactory disassembly was achievable for small consumer products, the energy expenditure would be too large to parallel those disassembly solutions to an automotive situation. However, by creating electrically triggered and locally heated disassembly solutions, automotive disassembly solutions could be further fed back and incorporated into consumer products. Examples could be local electrical ADSM to remove Mercury containing parts that would present a vapour hazard in a trommel, or to remove Alkali Metals and power sources that would be hazardous in a water bath.

6.2.3 Product Retro-fitting and Advantages Over the Suga Selective Disassembly System

The developed electrically triggered fastening solutions can be simply retrofitted into existing product structures by product designers, without the need for high-level diverse knowledge. For example, an electrically triggered SMP snap-fit can be incorporated as a 'drop in' solution into a product structure currently based around snap-fits. Additional accommodation for the two flying leads must be found, power must be sourced, and a biasing spring may have to be housed- all tasks not beyond a product or industrial designer. However- to incorporate selective disassembly technologies such as Debonding Using a Hydrogen Storage Alloy^{68,69,70} requires a great deal of chemical appreciation and

an extremely special low-pressure environment to achieve disassembly. Unlike the *Brunel* ADSM solutions, these solutions require design skills beyond traditionally educated designers, and are extremely difficult to engineer into products. This is not to say that an innovative 'active disassembly' solution is not useful in an aerospace situation where costs of Gallium based alloys are not so prohibitive, but the solutions are too complex for automotive or product disassembly.

6.2.4 Compatibility with Product Embedded Strategies

The product embedded strategy is elegant from the perspective that the disassembly mechanism lies embedded and inert for the total useful life of the product and only achieves disassembly when activated. Currently, disassembly is only destructive, and there is not the option of designing to 'save' a part or providing strict 'disassembly' as opposed to 'destruction'. This is where electrically triggered ADSM can score over the product embedded strategy, as it offers the characteristics of being both a disassembly tool (destructive or non-destructive), and remaining inert and embedded. The energy consumption of electrically triggered clips is also lower due to the shorter lengths of heating wire (187mm per clip as opposed to the circumference of a CRT screen) used. Electrical ADSM has effectively moved the product embedded concept on to a new level.

6.2.4 The Complementary Recycling Infrastructure: WERG

The evolution of a product disassembly system that can be selectively disassembled when the EoL condition occurs is a beneficial waste processing strategy to those recycling systems requiring pure or sorted waste streams. The WERG at *Brighton University* is successfully developing waste reprocessing solutions for post shredder polymer waste⁷³ and relies on pure sorted waste streams. This recycling strategy has historically relied upon the shredder for sorting the polymer fractions from the overall vehicle. Active disassembly can allow sorted waste streams for further use to be generated at EoL when

the vehicle is disassembled. Not only can separated polymer parts be simply sorted for further reuse, but also the parts remain free from any shredder residue pollution.

6.2.5 The Complementary Recycling Infrastructure: Cryogenic Separation

The *University of Ontario* has been working on cryogenic vehicle wiring separation to separate the copper containing vehicle wiring from the wiring insulation⁷¹. Although Active Disassembly would be of no benefit to the actual wiring reprocessing, ADSM can help in actually removing the wiring loom. *Henstock*⁶⁰ has already identified that wiring removal is a bottleneck in vehicle disassembly. By applying DfD principles to the initial vehicle design, and by incorporating active fixtures, the wiring itself can be removed and separated simply, for further cryogenic reprocessing.

6.3 INDUSTRY REACTION TO ADSM APPLIED TO ELVs

6.3.1 The Industrial Reaction

Further to the initial discussions with various industry insiders in Chapter 3 'User Pull', the outcomes of this ADSM investigation were re-presented to the industry to gauge a reaction, and to see if our investigation met with their wishes and demands.

6.3.2 Reaction from Centro Ricerche Fiat, Torino

Upon presentation of this investigation to the environmental engineers and materials scientists at the *Fiat* research centre in Turin, the initial reaction appeared to be one of disbelief. *Fiat* has been working on similar ideas internally since the late nineties, although not smart material based. The critical reason why *Fiat* favour this approach to achieving recycling targets is primarily cost based. In order to meet the required disassembly targets inside the 20-minute window, *Fiat* imagined the requirement of additional labour. *Fiat* now imagine that additional investment of Active Disassembly technology looks cheaper than investing in additional manual labour. *Fiat* have submitted an expression of interest for an EU Framework VI project with *Brunel University* to further this idea. It

can be summarised that there is strong positive commitment from *Fiat* to the development of this technology for vehicle recycling.

6.3.3 Reaction from Ford Motor Company, USA

Although in Chapter 3, we sought the advice from *Ford*, Dunton Green in the UK, further input and review came from the *Ford Motor Company*, USA. *Ford* in the USA read the details of the research on active glass removal⁹³ and sought additional information. The US branches of their materials processing department have been undertaking research into the characteristics of SMPs, but sought guidance on their suitability for automotive applications. Again, their scientists showed a keen interest, and they have asked to be kept informed of any further developments or if they can be of any further assistance. For the next stages of work, access to environmental test chambers and integrity test procedures would be useful for fully evaluating resolved fastener designs.

6.3.4 Reaction from Charles Trent Ltd.

Charles Trent Ltd. has one of the largest throughputs of ELVs in the UK, and bails in excess of 6000 of ELVs every year. They are reluctant to stretch the 20-minute window as every additional minute spent on each vehicle corresponds to a drop in profit. For this reason vehicles are not usually further dismantled by crane once processed, but are usually simply bailed. Any robust technology allowing increased separation and revenue is of interest, and automotive ADSM was also of interest. It is the vehicle dismantler who actually 'experiences' the 20-minute window, and it is also the vehicle dismantler who wishes to maximise profit in this time space. According to *Charles Trent*, automotive ADSM looks like a robust and effective solution, and from their perspective would make many aspects of disassembly simpler.

6.3.5 Reaction from the Unaffiliated Yard

The unaffiliated, reactive dismantler has no concern with technology advances. They will simply do what is necessary to keep legally compliant and retain their dismantling licence. They would rather not have to invest any more at all beyond the one million or so pounds that investing in depollution stations, dedicated workspaces, holding tanks, and placing the entire stock-yard on a concrete plinth has cost. They generally process so many cars due to council contracts that they are not really interested in the small percentage revenue for small light fractions. Active disassembly is from their perspective of no interest other than appearing novel.

6.4 CHAPTER SUMMARY

From retrospectively analysing the creation of automotive ADSM, and how it fits in with automotive industry as investigated in chapters 2 and 3 of the study, it can be seen that Automotive ADSM is a useful technology from both a manufacturers and dismantlers perspective. Due to the current timeframe associated with the implementation of the EU ELV directive, the work has been met with receptive ears. The enthusiasm shown by both conference organisers wanting to feature the work, and the willingness of both *Ford* and *Fiat* to further the work started by this study again shows that this investigation has been worthwhile.

Chapter 7

Conclusions

7.1 INTRODUCTION

As we have seen in the preceding chapters, active disassembly technology can be applied to vehicles in a number of different areas to give effective results. In order for ADSM to be effective in EoL scenarios, the technology must compete with, or compliment existing shredder technology. The shredder is effective at providing efficient material sorting, particularly when followed by post shredder sorting techniques such as eddy current separation and dense media separation with float/ sink tanks.

In keeping with the spirit of the ELV directive, the aim of the research has been to both increase the recyclability and reuse of ELVs and to decrease shredder residue. As we have seen, with a 20- minute window in the time the ELV remains in the depollution station, a variety of ADSM solutions could be deployed.

ADSM solutions can aid ELV directive compliance as they provide a means of recovering an extra 10 % of materials (by mass) that would otherwise be lost to the shredder. These materials are in the form of approximately 3% of the vehicle mass arising from the glass fraction, and approximately 8% of vehicle mass from the polymer fractions. (The materials composition of a typical 1990's car is detailed in fig 3.1, p.72).

This work on Active Automotive Disassembly has been presented internationally at various conferences^{79, 85, 87}, and has formed the basis for three journal publications^{65, 93, 95}.

7.2 CHAPTER SUMMARIES

This section summarises the conclusions drawn from preceding chapters.

7.2.1 Synopsis of Chapter 3

Chapter 3 centres around formally establishing the direction for the investigation to take in order to safely aid ELV directive compliance. It was found that ADSM can potentially be usefully integrated into vehicles in the following areas:

- Glass removal
- Wiring removal
- IP removal
- Steering-wheel removal
- Further IP disassembly.

A series of ADSM design guidelines were also established. These addressed ways in which ADSM technology could be successfully integrated into products at the design stage. These guidelines cover:

- Heating and triggering
- Product architecture
- Local architecture.

7.2.2 Synopsis of Chapter 4

Chapter 4 is based around four individual disassembly case studies. These case studies prove the viability of ADSM as a separation technology for EoL vehicles. The studies also highlight that the triggering of conventional ADSM devices can be difficult.

7.2.2.1 Active Glass Removal

It has been demonstrated that ADSM SMA retention solutions can be utilised- although they would be expensive for retaining glass. SMP solutions are far more cost beneficial, although presently their temperature ranges (T_g) lay outside of a useful temperature spectrum⁷⁹. Further development is 'on hold' whilst the materials science is further explored by Mitsubishi Heavy Industries.

7.2.2.2 Active Steering-Wheel Removal

SMA's have the integrity to be used in safety-critical applications. Triggering mechanisms for the disassembly of vehicles at depollution stations will be most satisfactorily realised either in the form of hot probe for disassembly, or CO₂ injection for disassembly⁸⁵.

These methods are both robust and easy to use. The triggering of ADSM with hot air systems, hot fluid immersion, or inductive triggering is not relevant for such a large assembly. With the triggering and release of the steering wheel mounted airbag, we can see the way through to then releasing the instrument panel. As discussed in section 2.10.2, as a plastics dominated part this is an ideal candidate assembly for complete ADSM. Currently, vehicle dismantlers are working with 'first generation' depollution stations. These are of a modular construction and would need to be expanded to encompass hot probe disassembly devices, or have a CO₂ injection facility to trigger cryogenic devices.

7.2.2.3 SM-HALF

SM-HALF is an interesting potential product with possible applications outside the automotive area. SMP is currently not a viable technology to be used in exposed vehicle parts. However, whilst testing the SM-HALF, the qualities of the adhesives used raised interesting questions about their suitability for use as a method of achieving Active Disassembly.

7.2.2.4 The EcoCar Instrument Panel

Concept solutions were all integrated into one assembly to provide a hierarchical disassembly system. The triggering of shape memory devices by indirect heating methods can be inefficient and inconvenient. By planning the instrument panel to disassemble electrically, the potential for electrical ADSM was proven to warrant further investigation.

7.2.3 Synopsis of Chapter 5

In refining an electrical disassembly system, several areas were investigated. These investigations prove the viability of electrically triggered ADSM at EoL, and that electrical ADSM can lead to a more efficient recycling infrastructure.

7.2.3.1 Energy Evaluation

As we have seen from Chapter 5, there is more than adequate energy remaining in both the batteries in end of life mobile telephones, and EoL vehicle batteries to provide energy for disassembly.

The energy in an EoL vehicle battery is enough to reliably trigger 16, 25-micron diameter muscle wires, or 1, 100-micron wire, or combinations thereof. The results table in Chapter 5 illustrates how many individual devices 65 Joules of energy can deliver.

In comparison, there is not a huge amount of difference between the residual energy of the *worst case* EoL vehicle batteries, and the EoL telephone batteries (65 Joules vs. 43 Joules). They do however deliver their power in different ways. The telephone batteries were unable to deliver sufficient current when their terminal voltage dropped below 0.5 volts, where the vehicle batteries were able to deliver sufficient current for longer. The vehicle batteries were able to deliver the required energy, as despite their terminal voltage dropping to 0.17 Volts, the current able to be delivered is much higher due to a lower internal resistance. However, battery 5 aside, most of the other ELV batteries contained at least 100 times more energy than that of the EoL telephone batteries. The important observation was that high levels of residual energy could *not be guaranteed* in an EoL ELV battery. Therefore, for larger numbers of Active Devices to be powered, external power sources may have to be used if the actual vehicle battery in question is particularly unhealthy.

7.2.3.2 Electrically Heated Fasteners

Both SMA and SMP fasteners can be triggered by electrical heating.

- NiTi devices triggered by NiChrome wires wrapped around the clip proved to be less efficient than direct electrical connection of NiTi muscle-wire mechanism
- Direct electrical connection of larger (mm as opposed to μm) diameter NiTi draws a very large current and therefore uses a large amount of energy
- SMP fixtures with integral heating devices heat most efficiently
- The low force associated with the shape recovery of SMP means fixture geometry (low stiffness) is critical, or a biasing spring must be incorporated into the fastener design to ensure shape recovery.

7.2.3.3 Design for Electrical Disassembly

Based upon calculations for a manually disassembling an Instrument panel, a comparison could be made with an electrically disassembled instrument panel.

-
- By incorporating electrically heated fasteners, disassembly time for a vehicle IP can be reduced by approx. 50%
 - The current DfD methodology is useful for comparison only
 - An updated methodology for non disassembly-line products could provide more accurate disassembly summaries.
-

7.3 FURTHER WORK-

A number of key areas requiring further work have been identified:

7.3.1 Shape Memory of Engineering Polymers

Further work into the shape recovery of engineering polymers needs to be undertaken if the concept of polymer relaxation for automotive disassembly is to progress. Whilst work is underway by *Hussein et al*⁸³ on shape recovery of polymer structures, investigation into filament relaxation is not part of this work. This could lead to the development of relaxing woven structures, and the creation of a woven SM-HALF system.

7.3.2 Releasable Adhesives

Adhesive release was observed in Chapter 4.3. Further work to characterise adhesive performance would be desirable. Where polymer relaxation and integrity loss has conventionally been an undesirable performance- but had been desirable for ADSM, capitalising on adhesive release could further expand the diversity of releasable joint applications. Establishing a low cost disassembly system using already developed technology could help decrease the implementation time of ADSM technology

7.3.3 Direct Electrical Connections

The conclusions drawn from the analysis of information on ELV batteries show the EoL battery energy content can be very low. There are still alternative methods however for powering electrical disassembly. The solutions we have proposed, look at using residual battery energy and will not retrofit. By producing embedded designs that are integrated into the vehicles wiring structure, *but are wired for triggering by external power*, opens up the possibility for embedding an unlimited number of devices. It will be necessary to ensure that the devices can only be triggered by the depollution station or service centre. By using a robust 'engine management unit' (EMU) type interrogation tool, power on demand can be delivered to those fasteners that need to be removed. The risk of 'wasting' residual energy is avoided. Development into electronic disassembly tools and efficient energy distribution needs to be investigated

7.3.4 The Blue Tooth Bolt

As already stated, as a part of the whole DfE system, consideration must be given to DFA, DfD, DfR and DfMo. We have already abstracted a design for disassembly system into a design for *self*-disassembly system; ADSM system can further evolve from a Design for Maintainability system into a Design for *self*-maintainability architecture

Looking further to the future, and to the continued development of wireless multiplexing systems; eventually even the manual plugging in of the EMU diagnostic tool will be replaced by a wireless transmission. Triggering each 'bolt' remotely could then become a possibility. The system would still require power, which again could come from direct electrical connection, or could come remotely in the form of microwave energy.

7.3.5 Electrically Triggered SM-HALF

We have already seen the concept of SM-HALF realised as a working fixture solution. However, in a similar way to the way SMA materials have been triggered by induction or

microwave heating, so too could SM-HALF. By producing a 'doped' SMP material, there is the possibility of creating a releasable Velcro system that can be released remotely from its location embedded inside a product. Obviously the polymer will require some development to ensure the desirable thermal and mechanical properties are retained, but in principle, the system could be created. Also, further to this, current Velcro loops are manufactured using a patented continuous injection moulding system⁹⁴. If this system is to be commercially successful, production will have to be undertaken on a large commercial basis, moving away from the gravity casting of small SM-HALF sheets, to a continuous production technique.

We can also look at our evolutionary process for electrically triggering SMA clips, and move on to developing electrically triggered SMP systems. By using Hi-garde Velcro as one half of the SMP Velcro system, we have a means of electrically providing current to the conductive polymer system. Alternatively, we can again take the inventive step of using the fine filaments of the Hi-garde 'loops' and effectively have a whole series of small 'heating elements', that can heat the SM-HALF system and release the joint.

References

1. Avery, I., Natural Resources Initiative Manager, Hampshire County Council, at SEEBA Automotive Law Update, Surrey, England , May 27th 2003
2. Abandoned Vehicles: Executive Summary. Maidstone Borough Council 2002
3. Gaskin, I., Environmental Director, Universal Vehicle Services PLC, at SEEBA Automotive Law Update, Surrey, England , Nov 21st 2001
4. Smith, C., Glasses Guide. 'Newsdesk' article, Recycling World. Issue 349 pp11
5. Chiodo, J., Harrison, D., Billett, E., 'An initial investigation into active disassembly using shape memory polymers'. In, The Journal of Engineering Manufacture. Vol. 215 No B5. Pp 733-741 (Special Issue on Recycling in Manufacture), Institution of Mechanical Engineers 2001
6. Chiodo, J. D., Billett, E. H., Harrison, D. J., Harry, P. M., 'Investigations of Generic Self Disassembly Using Shape Memory Alloys.' IEEE 1998: International Symposium on Electronics and the Environment, 4-6 May, Oak Brook, Illinois. Pp. 82-87

7. Chiodo, J. D., Billett, E. H., Harrison, D. J. Anson, A., 'Active Disassembly using Smart materials (ADSM) Introductory Materials Overview.' In, Proceedings of the Fourth International Conference on Ecomaterials, Gifu, Japan. The Society of Non-Traditional Technology, 1999. Pp.95-98
8. Directive of the European Parliament and the Council on Waste Electrical and Electronic Equipment 2002/96/EC - WEEE 2003/0084/COD
9. Directive of the European Parliament and the Council on End of Life Vehicles 1997/0194 (COD) Annex I in accordance with Article 6 (1) and (3). Pp.20
10. European Metal Recycling (EMR Ltd.) Company Literature, Clarendon House, Salford, 2001
11. Stoneham, P., and Wright, C., Competitive Analyst Specialists, Visteon UK Ltd., at at SEEBA Automotive Law Update, Surrey, England, May 27th 2003
12. Recycling World Magazine. News desk Article 02/06/00
13. Directive 2000/53/EC of the Department of the European Parliament and of the Council, of 18 September 2000 on End of Life Vehicles, Article 7
14. Directive of the European Parliament and the Council on End of Life Vehicles 1997/0194 (COD) Annex II Materials and Components Exempt from Article 4 (2)(a). Pp.22.
15. International Dismantling Information System, <http://www.idis2.com/> IDIS Plant Version 2.0.2, ©IDIS 2 Consortium, 2000

16. Consortium for Automotive Recycling (CARE) <http://www.caregroup.org.uk>
©CARE Group UK 2000-2003
17. Vehicle Recycling. Ford Environmental Policy. FORMOCO Essex, CM13 3BW
18. Recycling. BMW Promotional Literature. BMW Landshut, Germany 2000
19. Seo, S., Shibata, K., Asakura, K., Akiyama, Y., 'Effects of Alloying Elements and Grain Size of Austenite on Hot Surface Shortness in Copper Containing Steel'. In, Proceedings of the Fourth International Conference on Ecomaterials. Gifu, Japan. The Society of Non- Traditional Technology , 1999. Pp.49
20. British Metals Recycling Association (BMRA) <http://www.britmetrec.org.uk> ,
formerly the British Metal Federation, Huntingdon, Cambs. UK, 2003
21. Recycling of Plastics. BMW Promotional Literature. BMW Landshut, Germany 2000
22. Research for the Future- Recycling at Volkswagen. Volkswagen Promotional Literature, Wolfsburg, Germany 2001
23. Chiodo, J. D. Part II of: Final EPSRC Grant GR/L74385 Project Report,
'Active Disassembly using Smart Materials (ADSM): Design Principles.' 16 June 2000
24. A. Lukkarinen and K. Kaski., 'Computational Studies of Compressed and Sheared Electrorheological Fluid', in Journal of Physics. D: Applied Physics., 29:2729-2732, 1996

25. Dagger, B., 'Developing New Products- Sounds good!', in 'Engineering Designer', the Journal of the IED. November 2000
26. Henry, C. P., O'Handley R. C et al, 'AC Performance and Modelling of Ferromagnetic Shape Memory Actuators', in proceedings of 'SPIE Conference', 29 July - 3 August 2001, San Diego, California, USA
27. Patent No. WO0164421 Patent for Pressed Pill Capsules Using A Soluble Polymer. PVAXX Ltd, Malmesbury, Wiltshire
28. Kenning, D., 'The Splendid Eco-Car. A Demonstration of Radical Future Solutions for Sustainable Transport.' In, Proceedings of ELV 2002 End of Life Vehicle Conference. Warwick, England, 9th September 2002. Warwick Manufacturing Group, University of Warwick
29. Liu, C. T., 'Shape Memory Materials and Phenomena- Fundamental Aspects and Applications', Materials Research Society 1992, pp. xi
30. Tautzenberger, P., 'Thermal Actuators:A Comparison of Shape Memory Alloys with Thermostatic Bimetals and Wax Actuators', in, 'Engineering Aspects of Shape Memory Alloys', (Duerig, T. W., Melton, K. N., Stockel, D. and Wayman, C.M., ed) Butterworth-Heinmann, New York 1990, pp.208
31. Gordon, R. F., 'Design Principles for Cu-Zn-Al Actuators', in 'Engineering Aspects of Shape Memory Alloys', (Duerig, T. W., Melton, K. N., Stockel, D. and Wayman, C.M., ed), Butterworth-Heinmann, New York 1990 pp.245

-
32. Harrison, J.D., 'Measurable Changes in Concomitant with the Shape Memory Effect Transformation', In 'Engineering Aspects of Shape Memory Alloys', (Duerig, T. W., Melton, K. N., Stockel, D. and Wayman, C.M., ed) Butterworth-Heinmann, New York 1990, Pp 106-111
33. Otsuka, K., and Wayman, C., 'Shape Memory Materials', Cambridge University Press, 1998, pp.203-219
34. Hodgson, D. E., Wu, M. H., Biermann, R. J., 'Shape Memory Alloys', SMA-Inc (Major Shape Memory Alloy producer). <http://www.sma-inc.com/smapaper.html>
35. Perkins, J. and Hodgson, D., 'The Two Way Shape Memory Effect', in 'Engineering Aspects of Shape Memory Alloys', (Duerig, T. W., Melton, K. N., Stockel, D. and Wayman, C.M., ed), Butterworth-Heinmann, New York 1990. Pp.195-206
36. Humbeek, K. E., and Cederstrom, J., 'The Present State of Shape Memory Materials and Barriers Still to be Overcome'. In, Proceedings of 'SMST-94 The First International Conference on Shape Memory and Superelastic Technologies'. Pacific Grove, California. Library of Congress Catalogue-in-publication Data, 1994. Pp4
37. Shutov, F., 'Mechanical Recycling of Polyurethane Scrap', in 'Recycling of Polyurethanes, Ed, Frisch, K.C., Klempner, D., and Prentice, G. Technomic Publishing Co. 1999
38. Humbeek, K. E., and Cederstrom, J., 'The Present State of Shape Memory Materials and Barriers Still to be Overcome'. In, Proceedings of 'SMST-94 The First International Conference on Shape Memory and Superelastic Technologies'. Pacific Grove, California. Library of Congress Catalogue-in-publication Data, 1994. Pp3

-
39. Uchino, K. 'Shape Memory Ceramics', in 'Shape Memory Materials', ed, Otsuka, K. and Wayman, C. M. Cambridge University Press 1998, pp185-188
40. Diem, W., Piezo Injectors Push Diesel Technology Forward. AutoTechnology. Volume 1. April 2001. Pp34
41. Matthy, E. F. 'Measurement of Velocity for Polymeric Fluids by a Photochromic Flow Visualisation Technique: The Tubeless Siphon,' in the Journal of Rheology, Vol. 132, 1988 pp775
42. Petek, N. K., Romstadt, D. J., Lizell, M. B., and Weyenberg, T.R., 'Demonstration of An Automotive Semi-Active Suspension Using Electrorheological Fluid', SAE Technical Papers, Document Number: 950586
43. Ashley, S. 'Magnetostrictive Actuators', in 'Mechanical Engineering', Journal of The American Society of Mechanical Engineers, June 1998.
44. Anjanappa, M., and Bi, J., 'A Theoretical and Experimental Study of Magnetostrictive Mini-Actuators,' in the 'Journal of Smart Materials and Structures,' 3 (1994) Pp83-91
45. Tellinen, J., Suorsa, I., Jaaskelainen, A., Aaltio, I., Ullakko, K., 'Basic Properties of Magnetic Shape Memory Actuators', in Proceedings, 8th International Conference, Actuator 2002, Bremen Germany, 10-12 June 2002
46. Melton, K. N., 'General Applications of SMA's and Smart Materials', in 'Shape Memory Materials', ed, Otsuka, K. and Wayman, C. M. Cambridge University Press 1998, pp.221-223

47. Williams, D.F., 'The Biocompatibility of Shape Memory Alloys', in Medical Applications for Shape Memory Alloys (SMA), I Mech E Seminar Publications 1999. ISBN 1860582419
48. 'SMP Drysuits', New Scientist 31 March 2001, pp22
49. 'An Expedition', Promotional literature, Diaplex, SMP breathable fabric manufacturer, Mitsubishi, Japan, 2000, <http://www.diaplex.com>
50. Langer, R. S., 'Biomaterials and How They Will Change our Lives,' in MIT world, MIT March 8th 2002
51. Arnaiz, S., Bodenhofer, K., Hermann, C., Hussein, H., Irasari, L. M., Schneck, D., Tanskanen, P., 'Invited Session: Active Disassembly Using Smart Materials (ADSM) A Status Report of the Ongoing EU Project', Care Innovation, Vienna 2002
52. Huuhtanen, T., 'Disassembly of Mobile Phones with Induction Heating', in the 'International Electronics Recycling Congress', ICM, Basel, Switzerland. Jan 13-15 2003
53. Tanskanen, P., and Takola, R., 'Concept of a Mobile Terminal With Active Disassembly', in proceedings of 'International Electronics Recycling Congress', ICM, Davos, Switzerland. Jan 9-11 2002
54. Boothroyd, G., Dewhurst, P. and Knight, W., 'Product Design for Manufacture and Assembly' Pub. Marcel Dekker Inc, 1994, Chapter 1.

55. Redford, A., and Chal, J., 'Design for Assembly, Principles and Practice', McGraw-Hill Book Company, 1994, Part III/ Chapters 6-9
56. Dowie-Bhamra, T., 'Product Design for Disassembly', in 'green' issue of Co-Design. Jan/ Feb/ Mar 1996 Vol. 5/6 pp28-33. ISSN 1355302X
57. Dowie, T., 'A Disassembly Planning and Optimisation Methodology for Design', PhD Thesis, Manchester Metropolitan University, 1995
58. German DIN Standard VDI 2243 (1991) Recycling Oriented Product Development', Dusseldorf, VDI
59. Beitz, W., 'Designing for Ease of Recycling', in the 'Journal of Engineering Design', Volume 4 Issue 1
60. Henstock, M. E., 'Design for Recyclability', Institute of Metals 1988. Chapter 5
61. Miller, D.P., 'The Effects of Ergonomic Stressors on Process Tool Maintenance and Utilisation', SEMATECH Technology Transfer Report 98023456A-ENG, March 1998
62. Kamrani, A. K., Salhieh, S. M., 'Product Design for Modularity'. Kluwer Academic Publishers 2002, ISBN 1-4020-7073-X
63. Boothroyd, G., Dewhurst, P. and Knight, W., 'Product Design for Manufacture and Assembly' Pub. Marcel Dekker Inc, 1994, Chapter 1

-
64. Dalglish, G. F., Jared, G. E. M., and Swift, K. G., 'Design for Assembly: Influencing the Design Process in 'Journal of Engineering Design', Vol. 11, issue 1, March 2000
65. Chiodo, J.D., Jones, N., Billett, E. H. and Harrison, D. J., 'Shape Memory Alloy Actuators for Active Disassembly Using 'Smart' Materials of Consumer Electronic Products', in Journal of Materials and Design, Issue 23, 2002. Elsevier 471-478
66. Masui, K., Mizuhara, K., Ishii, K., Rose, C. M., 'Development of Products Embedded Disassembly Process Based on End of Life Strategies', in proceedings of the First International Symposium on Environmentally Conscious Design and Inverse Manufacturing. Tokyo, Japan IEEE, 1999
67. Masanobu, Tanigawa, and Yu Kagami., 'Study of Auto Disassembly System Using Shape Memory Alloy', in the 'Fifth International Conference on EcoBalance', The Society of Non-traditional Technology Ecomaterials Forum, Nov 6-9 2002
68. Hosoda, N., Kitaoka, F., Suga, T., Selective Disassembly. In, Proceedings of the Fourth International Conference on Ecomaterials. Gifu, Japan
69. Kitaoka, F., Hosoda, N., Suga, T., Reversible Interconnection Using Hydrogen Storage Alloy. In EcoDesign '99: First International Symposium on Environmentally Conscious Design and Inverse Manufacturing. Tokyo, Japan. The Society of Non-Traditional Technology, 1999. Pp. 597-599.
70. Suga, T., Hosada, N., 'Active Disassembly and Reversible Interconnection', in Proceedings of International Symposium of Electronics and the Environment', IEEE, San Francisco, USA, 2000

-
71. Bains, B., Yates., and Frise, P., 'Recovery of Copper from Automotive Wiring Harness', in 'R2000,' Toronto, Canada, June 2000
72. R. Hooper and C. A. Ambrose, "ELVs ? Excellent Lifetime Values", EFI Founders Day. Le Meridien Hotel, Brussels, Belgium November 14th 2000
73. C. A. Ambrose, R. Hooper, A. K. N. Potter and M. M. Singh, 'Diversion from Landfill: Quality Products from Valuable Plastics', in The Journal of 'Resources, Conservation and Recycling' Volume 36, Issue 4, November 2002, Pages 309-318
74. Warburg N., Herrmann C., Chiodo J.D. 'Accompanying the (Re-)Design of Products With Environmental Assessment (DfE) on the Example of ADSM', In IEEE/ISEE, Denver May 2001
75. Boks, C., 'The Relative Importance of Uncertainty Factors in Product End-of-Life Scenarios.', DFS publications 2002, ISBN 90-5155-013-8 pp. 270-278
76. Trent, C., '*Quality Recycled Spare Parts*', company literature 2001
77. Prum, N., 'Scrap Steel From ELV: A Valuable Secondary Ore Material for the Steel and Zinc Industries.' In proceedings of, 'International Automobile Recycling Congress (IARC)', Geneva, Switzerland, March 2001
78. Glasses Guide ICME repair manual 2000. Vol 1, pp547

79. Jones, N., Harrison, D., Chiodo, J., Billett, E., 'Design for Automotive Glass Removal Using Active Disassembly.' In, proceedings of, Automotive Transport and Technology (ATT 2002), Palais des Congres, Paris, France, 9-11 July 2002. SAE International
80. 'Durometer', Company literature. Winfield, Innovative liquid Cast Solutions, Buffalo, New York, 2001 <http://www.winfield-inds.com>
81. Furness, J. 'Engineering Plastics', Materials Information Service, Institute of Materials, 1999
82. Maxwell, J., 'Plastics. The Layman's Guide'. IOM Communications, Cambridge University Press, 1999
83. Hussein, H., 'Shape Recovery in Engineering Polymers for Active Disassembly, PhD thesis, Brunel University, Surrey, UK, work in progress 2003
84. Ford Engineering Material Specification, WSS-M15P4-E. Pp3-5. Ford Motor Company, Materials Engineering Department, Dunton Green, Essex, 2002
85. Jones, N., Harrison, D. J., Chiodo, J. D., Billett, E. H., 'Safe Steering Wheel Airbag Removal Using Active Disassembly', In, Proceedings of the DESIGN 2002 7th International Design conference- Dubrovnik, Croatia. May 14 - 17, 2002. Pp.655-660. ISBN 953-6314-45-6
86. Harrison, D., Jones, N., and Billett, E., Initial patent filing for 'Releasable Hook and Loop Fasteners. Patent filing no. GB0210835.5 May 11th 2002

-
87. Hussein, H., Jones, N., Simpson, P., Harrison, D., Lelliot, E., 'Design for Active Battery Removal in Mobile Telephones'. Proceedings of the International Congress on Battery Recycling, ICBR 2002- Vienna, Austria, 2-5 July 2002. ICM 2002
88. Stroud, K. A. 'Engineering Mathematics', Third Edition, Macmillan 1990, pp.621
89. Duracell technical data (Alkaline cells)- Duracell 2002
<http://www.duracell.com/oem/Primary/Alkaline>
90. Tuck, C. D. S. (ed.), 'Modern Battery Technology'. Ellis Horwood 1991. Pp.204-207.
91. Vincent, C. A., Scrosati, B., (ed.), 'Modern Batteries', Edward Arnold 1986 ISBN 0-7131-3469-0. Pp-30
92. Pellegrino, S., and Sokolowski, W. M., 'Thermomechanical Properties of Shape Memory Polymer Foam', Department of Engineering, University of Cambridge, UK
93. Jones, N., Harrison, D. J., Chiodo, J. D., Billett, E. H., 'Design for Automotive Glass Removal Using Active Disassembly', in the 'Journal of Materials and Manufacturing', SAE Transactions 2002. ISBN 0-7680-1289-9
94. Patents and Trademarks, Velcro Corporate and Company Information, © Velcro Industries B.V., 2001. <http://www.velcro.com>
95. Jones, N., Chiodo, J. D., Harrison, D. J., Hussein, H., Billett, E. H., 'Towards Self Disassembling Vehicles', in the Journal of Sustainable Product Design -in Press, Summer 2003, Kluwer Academic Press

-
96. Veerakamolmal, P., Gupta, S. M., 'Design of an Integrated Component Recovery System', in Proceedings of the 1998 IEEE International Symposium on Electronics and the Environment, Oak Brook, Illinois, May 1998
97. Gupta, S. M., Veerakamolmal, P., 'A Case-Based Reasoning Approach for the Optimal Planning of Disassembly Processes', in the Proceedings of the 1999 International Seminar on Reuse, Eindhoven, Netherlands, March 1-4 1999
98. Lee, K. M., Bailey-Vankuren, M., 'Modelling and Supervisory Control of a Disassembly Automation Work Cell Based on Blocking Topology', in IEEE Transactions on Robotics and Automation, Vol.7, No.1, pp175-180 1997
99. McCrossan, L., 'A handbook for interviewers : a manual of Social Survey practice and procedures on structured interviewing', 3rd ed, HMSO, 1991.
100. West Deutsche Rundfunk Filming, 'The EcoCar', "Dschungel" on 7th May, 21.00 - 21.45 (German time). ("Autoteile aus Chinagrass -Autor: Momo Rabenschlag; Ein neuer Baustoff soll in der Autoindustrie Furore machen - ohne Metall, ohne Kunststoff. Produziert wird er auf dem Feld und er gilt als biologisch abbaubar: Chinagrass. Scherz oder echte Alternative? Dschungel nimmt Autoteile aus Chinagrass unter die Lupe.")
101. Kenning, D., Mason, G., Tucker, N., Jones, N., Chiodo, J., 'The EcoCar' at the 'BBC Tomorrows World Live Show', Earls Court, London, 10-13 July 2002

Appendix A.

Performance of field affected 'Smart' Actuator Materials

Properties of smart actuator materials				
	Bulk Piezo(PLZT)	Multi-layered Piezo	Magnetostrictive Terfenol-D	MSM (Ni-Mn-Ga)
Control Field	Electric	Electric	Magnetic	Magnetic
Max Strain E ($\mu\text{m}/\text{mm}$) Linear	0.3	1.25	1.6	100
Youngs Modulus (GPa)	48-74	45-62	25-35	7.7*
Tensile Strength (MPa)	5-50	5-30	28	-
Compressive Strength (MPa)	60	50	700	700
Curie Temp. ($^{\circ}\text{C}$)	200-350	200-350	380	103**
Max Operating Temp. ($^{\circ}\text{C}$)	100	100	150	70**
Resistivity ($\Omega\cdot\text{m}$)	10^{10}	10^{10}	58×10^{-8}	80×10^{-8}
Relative permittivity	800-2400	800-2400	NA	NA
Relative permeability	1	1	3-10	1.5-40
Coupling factor (%)	75	70	75	75
Max Energy Density (KJ/m^3)	2	18.5	27	90
Field Strength for max. strain	2MV/m	2MV/m	240 KA/m	400KA/m

All information courtesy of Adaptamat Ltd.

* Measured when MSM sample oriented at a single martensite variant.

** Can be increased by changing the proportion of Ni-Mn-Ga elements.

Appendix B.**Performance PVAXX Water Soluble Injection Moulding Polymers**

Application	Grade designation	Solubility	Water Temperature °C		
			20°C	37°C	60°C
Injection Moulding					
			Time in seconds		
	C66	Cold Water	130	70	15
	C70		200	72	21
	C74		200	43	10
	W63	Warm Water	-	340	47
	W67		-	340	40
	W73		-	340	50

All information courtesy of PVAXX.

Definition of terms:

Breakdown- When the sample has lost all its mechanical strength and has fragmented

Sample size: (mm)- 60x 9x 0.9

Test method: Sample is semi- submerged into a water bath, without agitation and timed until mechanical breakdown has been observed. The time taken is recorded in seconds.

This procedure is repeated across the relevant temperature range.

CODE OF PRACTICE FOR THE DISPOSAL OF MOTOR VEHICLE SALVAGE

This Code of Practice must be fully and promptly complied with in all circumstances by insurers and salvage agents

	CATEGORY A	CATEGORY B	CATEGORY C	CATEGORY D
Definition	SCRAP only (i.e. with no economically salvageable parts and which is of value only for scrap metal) e.g. total burn outs	BREAK for spare parts if economically viable (excluding any residual scrap value).	REPAIRABLE but repair costs exceed the vehicle's pre accident value (PAV)	ALL OTHER REPAIRABLE VEHICLES
	These vehicles must never reappear on the road			
V23*	Form V23* must be submitted by the insurer, self-insurer or agent to DVLA as soon as the categorisation decision is made and without waiting for V5			V23 not required
	Note: The V23 marker should be considered a permanent part of the vehicle's history. In the event that it is necessary to recategorise a vehicle, this can be achieved by the insurer writing to DVLA giving the reasons, together with the accident date. The salvage agent should also be notified and MIAFTR updated			
	*It is anticipated that the V23 system will be replaced by direct notification to DVLA by MIAFTR			
V5	It is the responsibility of the keeper to notify DVLA when a vehicle is passed to an insurer following a total loss payment.			
	The keeper may authorise the insurer to act as his agent in notifying DVLA. Notification to DVLA should be returned as quickly as possible by completing either:			
	<ul style="list-style-type: none"> • Red section (V5/3) if the post-March 1997 version of the VRD is held, or • V5/1 if the pre-March 1997 version is held. 			
	The remaining parts of the V5 document must be securely disposed of.			The remaining parts of the V5 can be passed to the new owner
	A photocopy of the V5 should be given to the salvage buyer by the insurer to assist in identifying the salvage, and in the completion of the Notification of Destruction (form V860) when applicable.			
	DVLA will notify any activity to the police for investigation, withholding the issue of a replacement V5.		DVLA will notify any relicensing activity to police for investigation.	
MIAFTR "Loss type"	All total losses must be notified for entry on MIAFTR by the insurer/self-insurer/agent as per the Code of Practice category. Total burn-outs should be notified for entry on MIAFTR as "Fire".			
MIAFTR notes	Recovered stolen vehicles which are in a total loss condition must be categorised A, B, C or D as appropriate. Recovered stolen vehicles which are undamaged or with only minor damage must be notified to MIAFTR as recovered, not deleted. Any changes in a total loss category must be notified to MIAFTR immediately on re-classification.			
Database Notifications	All notifications to MIAFTR whether theft or damaged are passed to Equifax HPI and Experian for a finance check. The data agencies use the information to provide a vehicle check service to the motor trade and the public. It is essential that loss information on MIAFTR is accurate and up to date.			
Documentation	All insurer/self-insurer/agent documentation to salvage dealers in respect of individual items of salvage must categorise the salvage as either A, B, C or D. Salvage agents must maintain proper records in accordance with BVSF requirements (attached) so that an effective audit trail of purchases and disposals exists. Papers and records will be accessible to police and for the purposes of bona fide insurance fraud investigations. Salvage agents will record the identity of all vendors and purchasers of salvage. In the case of non-insurer vendors and all purchasers, identification will be by suitable documentation (e.g. card with photograph issued by the salvage agent).			
Responsibilities of the primary salvage agent in the treatment of salvage/vehicles	SALVAGE MUST BE CRUSHED. The vehicle identification number (VIN) plate must be removed at the earliest possible opportunity and either held in secure storage whilst awaiting disposal or securely disposed of. The stamped in VIN must be left in situ and not interfered with in any way.	Category B must be treated as Category A once salvageable parts have been removed. THE SHELL/FRAME/CHASSIS MUST BE CRUSHED. Air bags and seat belt components must be properly disposed of in accordance with manufacturers' instructions - the insurance industry requires that these items must never be re-sold.	To be sold on for repair	
	All tax discs (old and new) must be removed and registration plates removed/ covered by the salvage agent immediately to de-identify the vehicle on its registration number			
V860 (Notification of destruction)	Salvage agents must complete and return to DVLA a Notification of Destruction V860 which confirms that the salvage has been/will be crushed.	Salvage agents must complete and return to DVLA a Notification of Destruction V860 which confirms that the shell/frame/chassis parts have been/will be crushed. Identification marks on engines and any other salvaged parts must not be erased.	Not applicable	
	Copies of V860s must be retained by the salvage agent for a period of at least 2 years for audit purposes.			
Note 1	Vehicles suffering water damage will usually be categorised A or B. It is for the inspecting engineer to determine, given the specific circumstances such as type of water (fresh, contaminated or salt), depth of submersion etc., whether a vehicle should be categorised A, B, C or D.			
Note 2	All bodyshells other than those on Cat C & D salvage, or bodyshells the subject of replacement in service, must be crushed. (NB special arrangements may apply to manufacturers' bodyshell schemes.)			
Note 3	Insurers/self-insurers/agents are strongly encouraged to utilise only the services of those salvage agents/breakers who comply with the appropriate provisions of the Environmental Protection Act 1990.			
Note 4	Third party total losses should be categorised A, B, C or D, a MIAFTR entry made and a V23 issued in the normal way.			
Note 5	Insurers/self insurers/agents must always use their best endeavours to assume responsibility for the disposal of all categories of salvage, whether first or third party claims. If a claimant wishes to retain salvage, the insurer should point out the beneficial effects of the Code in reducing vehicle crime, the stigmatisation which will attach to the vehicle, and in respect of A/B salvage, the duty of care under waste regulation legislation.			

FLOW CHART FOR CATEGORISING VEHICLES

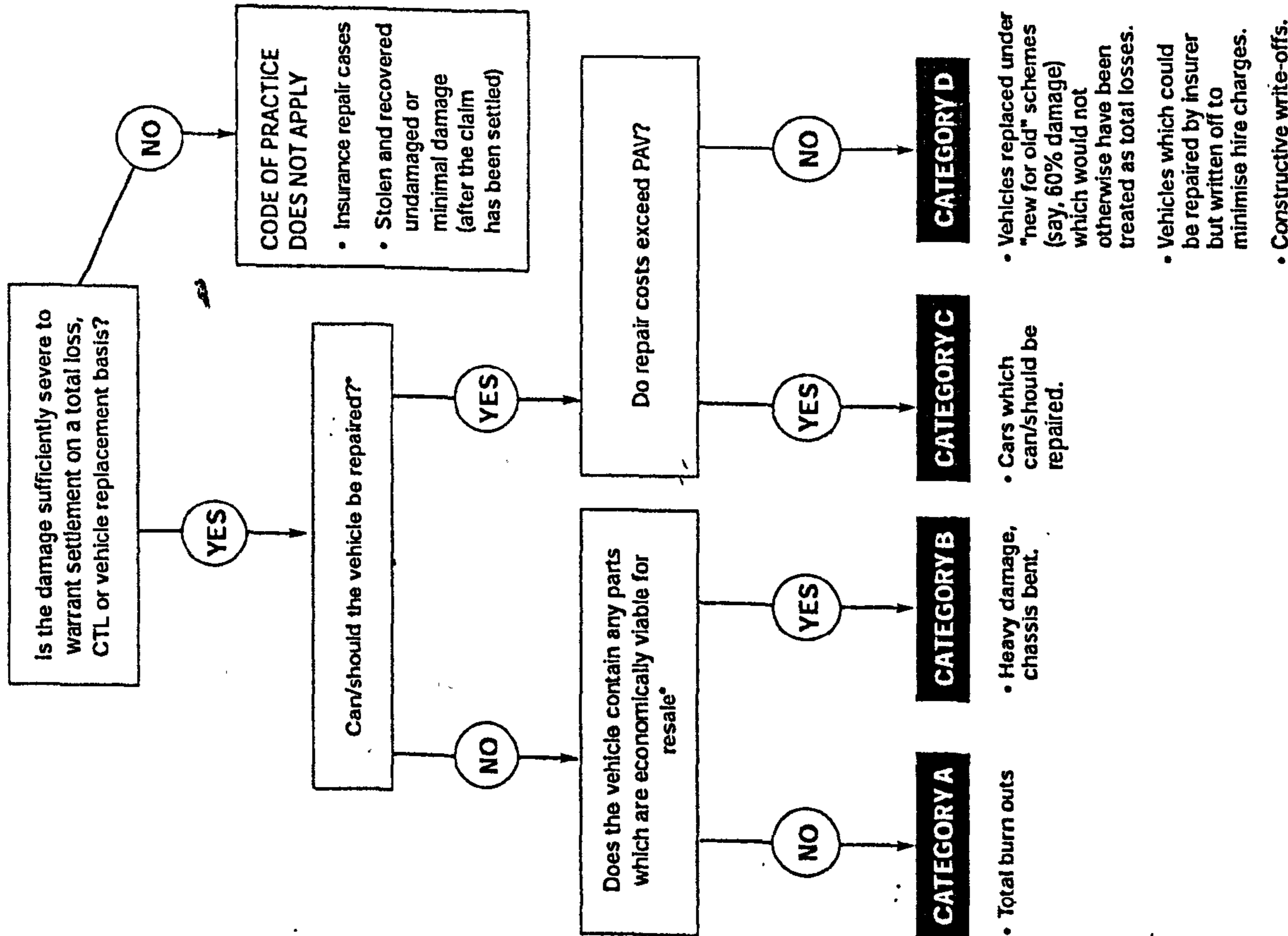

CODE OF PRACTICE

FOR THE DISPOSAL OF MOTOR VEHICLE SALVAGE

INTRODUCTION

This Code of Practice has been produced by and is supported by the Association British Insurers, Lloyds' Motor Underwriters' Association, British Vehicle Salvage Federation, Motor Vehicles Dismantlers Association, the Police, Institute of Trading Standards Administration and Government (Home Office and the Department of the Environment, Transport and the Regions/DVLA).

This Code gives directions on the steps to be taken in the treatment of vehicle salvage and recovered stolen vehicles.

The purpose of the Code is to detect and deter criminal activities and make vehicle histories much more transparent.

CATEGORISATION OF VEHICLE SALVAGE

Four categories of vehicle salvage have been defined. Details are given of the steps to be taken in advising DVLA and MIAFTR on each category, together with the consequential effects on action to be taken by the police; data agencies (Equifax - HPI and Experian) etc.

The inspecting engineer must decide, using current Thatcham guidelines, and indicate to which of the four categories a particular item of salvage belongs. Other than to correct inputting errors, removal of MIAFTR data is prohibited. Recategorisation may only be effected in exceptional circumstances (see V23 instructions overleaf).

In the event of a dispute between the insurer and the salvage agent regarding categorisation, the matter should be referred to a senior engineer nominated by the Insurer.

DVLA NOTIFICATION AND MIAFTR

Form V23* should always be completed and returned to DVLA in respect of Category A, B or C salvage. It is vital that the current version of Form V23 is used and completed correctly and accurately, in particular the choice of tick boxes which indicate whether the vehicle is either scrap/breaker or other category of total loss.

It is essential that notifications to MIAFTR are made properly and that amended/updated information is fed through quickly.

- It is anticipated that the V23 system will be replaced by direct notification to DVLA by MIAFTR.

CONCLUSION

The categorisation and notification of salvage as set out in this Code of Practice will make it difficult for criminals to ring vehicles or return dangerously repaired vehicles to the road.

This Code of Practice must be fully and promptly complied with in all circumstances by insurers and salvage agents.

DEFINITION

Throughout the Code all references to 'insurer' shall include 'self-insurer'.

* See Thatcham ETS Guidelines

Publications List

Journal Papers:

- Jones, N., Harrison, D. J., Chiodo, J. D., Billett, E. H., 'Design for Automotive Glass Removal Using Active Disassembly', in the 'Journal of Materials and Manufacturing', SAE Transactions 2002. ISBN 0-7680-1289-9
- Jones, N., Chiodo, J. D., Harrison, D. J., Hussein, H., Billett, E. H., 'Towards Self Disassembling Vehicles', submitted to the 'Journal of Sustainable Product Design' -in Publication, Summer 2003
- Chiodo, J. D., Jones, N., Billett, E. H., Harrison, D. J., 'Shape Memory Alloy Actuators for Active Disassembly using "smart" Materials of Consumer Electronic Products', in the Journal of Materials and Design, Volume 23 Issue 5- Summer 2002

Pending Journal papers:

- Jones, N., Harrison, D. J., Chiodo, J. D., Hussein, H., Billett, E. H., 'Electrically Triggered Active Automotive Disassembly with No External Energy Input', submitted to the 'Journal of Engineering Manufacture' (ImechE Journal B) -in review Winter 2002

Conference Papers, Trade Publications and Response Articles:

- Jones, N., Harrison, D. J., Hussein, H., Billett, E. H., 'Design for Self Powered, Self Disassembly of Vehicles', at the IED 'International Engineering and Product Design Education 2003' conference, Bournemouth, England. September 10-11, 2003
- Jones, N., Harrison, D. J., Billett, E. H., Chiodo, J. D., 'Self Disassembling Vehicles'. at the 'The End of Auto Life as We Know It?', RCA, London, England, 7th November 2002 Invited Speaker and Panel Member (In proceedings)
- Coppinger, R. 'Breaking Up Is Easy To Do.', Coverage of the work by Jones from the ELV 2002 conference. Published in 'The Engineer', September 13th 2002.

-
- Jones, N., Harrison, D. J., Billett, E. H., Chiodo, J. D., 'Self Disassembling Vehicles'. at the 'ELV 2002' conference, End of Life Vehicle Disposal Technical, Legislation, Economics. Warwick, England, 9-10 September 2002 (In proceedings)
 - Schweiger, E., Coverage of the work of Hussein and Jones from the ICBR 2002 conference. 'Neue Batteriegeneration Erfordert Zusätzliche Recyclingtechnologie', In Recycling Magazin August 26th, Pp18
 - Jones, N., Harrison, D. J., Chiodo, J. D., Billett, E. H., 'Design for Automotive Glass Removal Using Active Disassembly', at 'ATT 2002'- SAE Automotive and Transportation Technology Congress 2002- Paris, France, 9-11 July 2002 (In proceedings)
 - Hussein, H., Jones, N., Simpson, P., Harrison, D., Lelliott, E., 'Design for Active Battery Removal in Mobile Telephones', at the 'International Congress on Battery Recycling (ICBR) 2002'- Vienna, Austria, 2-5 July 2002
 - Jones, N., Harrison, D. J., Chiodo, J. D., Billett, E. H., 'Safe Steering Wheel Airbag Removal Using Active Disassembly', in Proceedings of DESIGN 2002 7th International Design conference- Dubrovnik, Croatia. May 14 - 17, 2002. Pp.655-660. ISBN 953-6314-45-6 (Reviewed)
 - Jones, N., Harrison, D. J., Billett, E. H., Chiodo, J. D., 'Active Automotive Disassembly Using Smart Materials', in 'Recycling International', March 2002 No.2, pp48
 - Jones, G., 'A Smarter Way To Build', Brunel News January 2002 Issue 46- Special 2001 Round-Up, pp3
 - Hussein, H., Jones, N., Harrison, D. J., Billett, E. H., Chiodo, J. D., 'Active Disassembly Using Smart Materials' at the 'International Electronics Recycling Congress', Davos, Switzerland. January 9-11 2002 (poster presentation)
 - Anderson, M., 'A Phone That Self-Destructs', in the Times Supplement '*Doors*', September 9th 2001, pp16
 - Jones, G., 'A Smarter Way To Build', Brunel News June 2001 Issue 40, pp6

- Jones, N., Harrison, D. J., Billett, E. H., Chiodo, J. D., 'Active Automotive Disassembly Using Smart Materials'. First International Automobile Recycling Congress- ICM, Geneva, Switzerland. March 5-7, 2001, (Flyer presentation)
- Jones, N., Harrison, D. J., Billett, E. H., Chiodo, J. D., 'Active Automotive Disassembly Using Smart Materials'. National Science Week- House of Commons, London, England. 19 March 2001 (poster presentation)
- Jones, N., Harrison, D. J., Billett, E. H., Chiodo, J. D., 'Active Automotive Disassembly Using Smart Materials', at the 'Institute of Materials Research Conference'- Institute of Materials, London, England. 24 May 2001. Proceedings on CD (paper No. MCR-02), edited by Matthews, S. O.

Pending Conference papers:

- Jones, N., Harrison, D. J., Hussein, H., Billett, E. H., 'Design for Self Disassembling Vehicles to Aid Service and Repair', submitted to the IMechE for the 'Driving the Future Vehicle Conference, November 11-12th 2003 (paper submitted)

Current Patent filings:

Releasable hook and Loop fasteners (Velcro ®), using Shape memory Polymers, Soluble polymers or stress biased engineering polymers. Nicholas Jones, Dr. David Harrison, Prof. Eric Billett (Patent filing date GB0210835.5, May 11th 2002).