

A CYBERNETIC APPROACH TO MANAGEMENT EDUCATION

AND

THE SCIENCE OF TEACHING

BY

KENNETH V LORIMER

This thesis is submitted for the degree of Doctor
of Philosophy, Brunel University, 1976.

A B S T R A C T

A CYBERNETIC APPROACH TO MANAGEMENT EDUCATION

AND

THE SCIENCE OF TEACHING

by

KENNETH V LORIMER

In this thesis the philosophy and mechanisms of Cybernetics are applied to Management Education.

A philosophical analysis of Management Education is developed and the notion of teleology introduced.

Change, dynamic stability and a concept of self-renewal are employed in a cybernetic framework for managing conflicting curricula demands from:

- (A) academics who are concerned with the intellectual good and analytical ability of their students;
- (B) representatives of industry, commerce and government who are concerned with manpower demands, and
- (C) students' demand for freedom to make up their own curricula from a menu of subjects chosen by them.

A model of a regulatory system is developed for controlling a teaching/learning situation to achieve a desired level of mastery. Such a system would contribute towards an improvement in the science of teaching.

The mechanisms of communication being parts of the study of Cybernetics are directly relevant to the teaching/learning situation. They form a means to an end

relationship, between a teacher and students in the transmission of knowledge.

A "black-box" approach to the processes of learning and problem solving is developed. From this approach evolved five essential phases to designing a protocol on how management students should learn what we (teachers) want them to learn. A case is presented to illustrate a learning process.

A reflective approach giving teachers a more realistic view (than that given by Newell, Shaw and Simon (1958) and Newell and Simon (1972)) of the important components for modelling how management students actually learn what we want them to learn is developed.

A curriculum design is presented in section 8 which contains basic forms of knowledge and arrangements for a worthwhile management scheme.

SYSTEM TWO is an operations system designed to implement the curriculum. It has advantages over committee arrangements and designed to accommodate co-operative educational programs for Management Education.

This research has a positive value in that it demonstrates, among other things that Cybernetics is a worthwhile field of discipline which is needed to improve:

- 1) the state of Management;
- 2) pedagogy, and
- 3) Management Education.

ACKNOWLEDGEMENTS

I wish to acknowledge my indebtedness to Professor Frank H. George, Head of Department of Cybernetics, Brunel University, who has throughout the past five years at Brunel inspired my thinking and provided valuable advice on this thesis.

I was greatly encouraged by Professor Stafford Beer who has provided an invaluable source of private and public knowledge on the problem of applying Cybernetics to Management.

I wish to express thanks to the educational research unit of the British Institute of Management for providing important materials and suggesting possible contacts during the survey part of my investigation.

Finally, I am grateful to Professor Gordon Pask and Dr. Mike Elstob of the Department of Cybernetics, Brunel University for providing useful discussions and comments on various aspects of my research and Mrs. Kilbride for her assistance.

C O N T E N T S

	<u>Page</u>
Abstract	1
Acknowledgements	3
1. Introduction	4
1:1 Aims of research	6
1:2 Research methods, procedures and strategy	7
2. Definition of Management Education	12
2:1 Directions of Management Education	13
2:2 Cybernetics and its relevance to Management Education	19
2:2.1 The relevance of teleology and purposeful behaviour to human and social systems	23
2:3 Proposed objectives for a management educational scheme, and a development of the discipline of Management	26
2:3.1 Corporate development	27
2:3.2 Organizational studies	28
2:3.3 Empirical and task measurement approach to Management	34
2:3.4 Human relations	39
2:3.5 Quantitative analysis and operational research techniques in Management	41
2:3.6 Cybernetic studies of human organization and Management	44
3. Some problems in assigning Management into the traditional categories of knowledge	49

	<u>Page</u>	
4.	Employing the mechanisms of control for designing an educational system	55
4:1	Change	56
4:1.2	Change and control	60
4:2	Stability and its meaning	61
4:2.1	Stability and the design of an educational system	62
4:2.2	Stability and self-renewal	63
4:2.3	Stability and curricula demands	64
4:3	Regulation as a mechanism of control	66
4:3.1	Regulation by error control	68
4:3.2	Regulation by a normative and anticipatory system	71
4/02	A model of Regulation by a normative and anticipatory system	74
4:3.3	Explanation and description of model in 4/02	75
4:3.4	Prescriptive sets of actions (as counters) to meet specified disturbances	81
4:3.5	Deduction and priority to goal rule for developing a structure and order of teaching complex tasks	91
4/04	A diagrammatic representation of the priority to goal rule	93
5.	Employing the mechanisms of communication and its technology for designing teaching systems	104

		<u>Page</u>
5:1	The mechanisms of communication	107
5/01	A schematic diagram of a general communication system	108
5:2	The teacher and the accuracy of meaning in the transmission of knowledge	111
5:3	Improving accuracy in the transmission of knowledge	113
5:4	Capacity of the communication channel	115
5:5	Building a canned case-teaching program supported by educational television	115
6.	The process of human learning, a blackbox approach	119
6:1	The first essential phase	121
6:2	The second essential phase	122
6:3	The third essential phase	126
6:3.A	A chartered shipping company's problem in the world grain market	126
6:3.B	An appropriate model of the (cognitive processors of the) learners	129
6:3.1	A guidance for designing an algorithm (solving the chartered shipping's company's problem as in 6:3.A)	130
6:3.2	Guidance and rules followed by examples for 6:3.A	136
6:4	The fourth essential phase	150
6:5	The fifth essential phase	151

	<u>Page</u>	
7.	Information processing and the phases of human learning and problem solving	152
7:1	A reflective approach to human learning and problem solving	152
7:2	Some essentials in modelling the phases and processes in human learning and problem solving with special reference to management students	158
7:3	Phases and processes of human learning and problem solving	161
8.	Designing a "whole-curriculum" for Management Education with an operations system	170
8/01	A diagrammatic representation of the scheme related to "the whole-curriculum"	174
8/71	An organizational structure of SYSTEM TWO	202
9.	Conclusion	209
Appendix 1	List of universities and educational institutions from which replies have been received	214
Appendix 11	A specimen of the questionnaire sent	215
	References	217

1. INTRODUCTION

Post-graduate Management Education in Britain, as good as it is by world standards, faces certain important educational problems, which if no positive step is taken to study and develop an enlightened framework within which to operate Management Education may become progressively ineffective and so different in form and in standards that it may cease to be a creditable and worthwhile discipline. The important educational problems may be described under three main areas for concern.

The first area for concern is a failure to provide an educational direction and dynamic stability in an educational situation which is mirrored in the form of two opposing positions, (A) and (B).

- (A) that since Management is now (from around 1964) included in the repertoire of subjects and disciplines being offered at university level then it should be pursued for the intellectual good and analytical ability of the students. And,
- (B) that the content of Management should be offered purely for vocational training and as such Management Education should only be provided to meet manpower demands of the country.

The second area for concern is the failure by many heads of business schools and of departments of management studies, and program directors who are responsible for developing masters degree schemes to provide an educational direction away from the opposing positions of (A) and (B). The alternative direction ought to have an extrinsic purpose which is committed to developing students beyond vocational demands, notwithstanding an acceptable standard (fixed by a consensus) of competency, in management practice.

The third area for concern is that not enough attention is paid to the science of teaching and other supportive systems for translating the objectives of a management educational scheme into goal directed actions in the teaching/learning situation.

Cybernetics is the study of the mechanisms of control, communication and teleology with special reference to purposeful and adaptive systems. A system is purposeful if:

- (i) it can select its own goal or purpose from different alternatives;
- (ii) it can change its goal or purpose over a definite point in time;
- (iii) it can change its strategies and develop new ones to achieve a goal or purpose;
- (iv) it can change its behaviour in response to a change or changes in the environment which affects its efficiency with respect to a goal or purpose; and

- (v) if the system seeks to modify its environment so as to regain some lost efficiency with respect to achieving a goal or a purpose.

Human beings, educational systems and business enterprises have the capabilities of being purposeful systems.

A system is adaptive if:

- (i) it has the ability to, and uses that ability to modify its behaviour in response to a change or changes in the environment which affects its efficiency with respect to a goal or purpose; or/and,
- (ii) it seeks to modify its environment so as to regain some lost efficiency with respect to achieving a goal or purpose.

In addition to the above examples, animals, man-machine systems and servo-mechanisms have the capability or may be designed to have the capability of an adaptive system.

1:1 AIMS OF RESEARCH

The aims of this research are:

1. To examine Management Education in the light of cybernetic thinking and to develop an enlightened framework within which an educational direction with dynamic stability may be given.

2. To apply cybernetic concepts and principles to Management Education. The effects of which would make a distinct contribution towards improving the standard of teaching and mastery of the essential forms of knowledge of Management; And,
3. To develop a framework and design a management educational scheme and supportive systems for a teaching/learning situation based on cybernetic concepts and principles.

1:2 RESEARCH METHODS, PROCEDURES AND STRATEGY

Approaches were made to 45 universities and educational institutions, a term denoting polytechnics and non-university colleges, in order to obtain information, on the objectives and content of their management educational schemes, and in the teaching/learning situations at the masters degree level by instructions.

Replies were received from 40 with mostly preprinted materials, prospectuses, reports and special papers. However, this research is not based solely on the survey procedure. For the information gained from the replies, taking into account their limitations — different background under which the data were provided; respondents having no obligation to reply; respondents having limited time, and the fact that information in prospectuses do not necessarily reveal the true state of affairs regarding the teaching/learning

situation — are useful in that they provided a way of identifying some of the main problems in Management Education. The data from the replies also provided information of sufficient generality from which certain evidence, assertions and inferences are presented.

A questionnaire and a follow up letter were sent to the Council for National Academic Awards (CNAA) to find out the Council's criteria for approving management educational schemes at the masters' degree level. A two way communication was established and a reply received.

Questionnaires to ex-students or graduands who have been awarded a masters' degree in Management or Business Administration or Administrative Studies were considered, but soon prove too expensive. After going through a cost exercise, it became clear that it was too costly to "hunt out" a random number of ex-students or on a stratified basis.

A variety of other sources of information was considered. The sources are: National reports in the serious press; the Times Higher Educational Supplement; conference meetings and discussions; the British Institute of Management meetings on issues and problems in Management, and informal interviews with senior lecturers, heads of departments and professors.

In addition to the survey method, a philosophical analysis of Management Education is developed, and the relevance of Cybernetics to the content of Management, Management Education and social systems shown.

A normative study employing the mechanisms of control and communication to educational systems develops.

A research strategy of testing the normative design against a criterion of worthwhileness is adopted since the time span for implementing a teaching system can take as much as five to ten years to take effect. The criterion of worthwhileness is to see if a teaching system which employs the concepts and mechanisms of Cybernetics could command a fair degree of merit from:

- (a) teachers in the field of Management Education and business studies;
- (b) professional teachers of any other disciplines or fields of disciplines;
- (c) educational technologists; and
- (d) students.

This strategy proved useful in that on 1st July, 1975 arrangements were made to have the proposed cybernetic framework for designing a teaching system developed at Concordia University, in Montreal, Canada. In this respect, two "modular courses" under the titles, "Educational Cybernetics", and "The Cybernetics of Instructional Design and Learning", were offered.

Sixty two students registered for the first "module", "Educational Cybernetics" and forty two students for the second "module", "The Cybernetics of Instructional Design and Learning".

The modular courses were offered at the masters' degree level by the Department of Education.

The students attended came from the following categories:

- (a) teachers of management and business studies, professional teachers and instructors from the CEGEP (College d'Enseignement general et professionnel), the University of Montreal and other educational institutions;
- (b) training officers from Air Canada and Canadian Pacific;
- (c) educational administrators;
- (d) educational technologists; and
- (e) students preparing for a masters' degree in Education.

A series of lectures, seminars and workshops were conducted where a framework for Educational Cybernetics was explained.

A cybernetic design of a teaching system was developed and presented and the concepts and mechanisms of Cybernetics explained.

A strategy was to get people to apply the concepts and principles of Cybernetics or the model of the normative and anticipatory system developed in this thesis to specific

11

teaching/learning situation. Reports on plans to develop a normative and anticipatory system have been favourable, but it will take at least another three to five years to assess the impact of cybernetics on the science of teaching.

Information processing and the phases of human learning and problem solving are examined and a reflective approach containing some essentials for modelling the phases and processes in human learning and problem solving with special reference to management students is developed.

A "whole curriculum" for a masters' degree scheme in Management is designed. Also, a framework for designing a supportive system at the operations level to support the curriculum objectives is developed.

2. DEFINITION OF MANAGEMENT EDUCATION

Management Education consists of those activities which are concerned with the initiation of students into a body of knowledge and experience termed Management. It is also concerned with developing their rationality, imagination and understanding in different forms of knowledge, experience, awareness and ability in Management well beyond the manpower demands of the country that are directly acquired by learning.

Management involves "a social process entailing responsibility for the effective economic planning and regulation of the operations of an enterprise in fulfilment of a given purpose or task", Brech, E.F.L.(1966). Such responsibility includes:

- (a) human problem solving, judgement and decision in determining plans, and control in the use of sets of resources to achieve one or more objectives, and
- (b) "the guidance, integration, motivation and supervision of the personnel composing the enterprise, and carrying out its operations", Breech, E.F.L.(1966).

Management Education involves the organization of a formal education scheme or program intended to educate students in a discipline, termed Management. The formal education schemes are usually organised by universities and

educational institutions approved by Charter.

Management Education excludes most in-company training which concentrates only on getting a trainee up to a particular level of activity which is limited to the extent of the job for which he is being trained.

It is conceivable that certain characteristics of training can be present in a management education scheme particularly, in the case of certain domain of knowledge in some of the unit course developed in section [8] of this thesis. But, the distinction between training and Education rests mainly, on the intention of a management educational scheme, and on how the program director conceives of what he is trying to bring about. With training, attention is focused on getting the trainee equipped for a job which is limited by its scope, whereas with Education, thought is given to the future development of students on the scheme.

2:1 DIRECTIONS OF MANAGEMENT EDUCATION

After examining the aims and content of the various educational schemes on Management from 40 universities and educational institutions two main approaches emerged, denoted by groups A and B.

Group A's Approach:

This approach adopts a posture that Management Education should be pursued for its own sake and to develop the analytical ability and intellectual good of students.

This posture is usually reflected in statements on aims or objectives of the instructional schemes for the masters' degrees in Management Studies, Business Administration, and Administrative Sciences. Here are some examples of the aims:

"to acquire an intellectual framework"

University of Salford;

"to develop generally their understanding of the management process", Scottish Business School;

"to develop graduates who can analyse situations logically, criticise effectively"

Durham Business School; and to develop analytical ability in the functional areas of management such as organisational behaviour, marketing, finance, industrial relations, and specialist areas such as operational research and systems studies, University of Warwick

The statements of educational aims and content of this group of universities and educational institutions suggest the presence of out-dated elements in current management educational schemes which are concerned with individual culture, and in the main, products of tradition.

The problem with the posture of this group is that while its members have made a significant improvement in their pre-1964 educational opinion about Management there is no conclusive evidence that improvement in the intellectual framework and analytical ability of students constitute sufficient qualities for good Management. According to Wheatcroft, M.(1970) in "The Revolution in British Management Education", British universities objections to business and management studies were of three main types:

- (i) "management had no academic content which could be taught;
- (ii) business subjects were vocational training and, hence not the proper function of a university, which was to develop its students' mind and give them a critical and analytical approach;
- (iii) the aim of business was thought to be to make money which was not considered an objective which academic education should encourage".

Group A's analytical approach to Management Education places too restrictive and not reflective enough a view on the processes and circumstances that precede the stages of analysis and logical decision-making. The effect of such a restrictive approach is to omit some key qualities and requirements for success in Management in an environment of competitiveness. The processes and circumstances referred to here are:

- (i) the complete process of searching the environment for conditions and opportunities which might be available to them;
- (ii) finding, inventing or developing ways to deal with potentially serious problems before they become critical, and
- (iii) recognizing and defining problems.

There is also the criticism, and not without justification, that the educational posture of this group places too much emphasis on:

- a) analytical methods and techniques, which very often are developed to the point of eccentricity;

- of little practical value and
- b) decision-making in the class-room.

Group B's Approach:

This approach adopts a posture that Management Education is purely vocational training and as such should only be provided to meet manpower demands of the country. This posture is adopted as a result of highly publicised demands from the Government and from spokesmen representing large corporations and the Confederation of British Industry.

The extent of Governmental and Industrial involvement in Management Education goes beyond just public demands. For the Government has been involved in Management Education, as in all areas of education, through the financing and policy making function of the Department of Education and Science (DES). The DES is assisted by the National Advisory Council for Education in Industry and Commerce, and in Scotland by the Scottish Technical Education Consultative Council. There are other bodies, local and regional, and Government Committees which claim to assist the Government.

Further evidence of involvement includes:

- (1) The National Economic Development Council (NEDC) which studied the problem of Management Education in 1961;
- (2) The Ministry of Education and Science and the BIM which established the Diploma in Management Studies in 1961;

- (3) Report on Higher Education under the chairmanship of Lord Robbins, 1961-1963, and
- (4) The Industrial Training Act (1964), and other subsequent reports showing a need for Management Education.

Industry and Commerce have been involved in Management Education through joint developmental activities, including research, and funding by means of grants, educational trusts, and gifts. Evidence of other involvement includes:

- (1) The Foundation of Management Education (FME) sponsored by the Confederation of British Industries (CBI) and the British Institute of Management (BIM) in 1960;
- (2) Federation of British Industries' report on Management Education and Training needs of Industry, in 1963;
- (3) Report on "British Business Schools" by Lord Franks, in 1963.

Some universities and educational institutions claim to meet these demands: "This Masters' Program has been designed for a specific clientele of students. It is intended to meet some of the most pressing needs of business and industry in Europe in the 70's and 80's", Cranfield School

of Management.

Manchester Business School and many others imply from their statements that they prepare students for the demands of industry, commerce and banking.

The researcher concedes as plausible, the argument that Management Education should be provided to meet manpower demands of the country. The grounds for this concession are based on a recognition that manpower demands constitute an important force in the country and should not be easily ignored, even from a criterion of worthwhileness having regard to technology and practice of Management. However, this concession does not mean full support is given to the proposition that Management Education should only be provided to meet manpower demands of the country.

The likely consequences of such a proposition, quite apart from making students and professors convenient tools of a government and industry, are as follows:

1. That Management Education would be subject to the very significant errors that occur in Government Manpower Planning. The teachers and colleges of education are now experiencing drastic retrenchment and closures, which are due to serious errors of Government Manpower Planning.
2. Economic demands, product life-cycles and technology change rapidly, hence students who are trained specifically for the manpower needs in 1970, may find themselves becoming redundant by 1980 because the demands of industry have changed, and

3. By allowing the aims or objectives of management educational schemes to be determined by spokesmen for the Government and Industry were tantamount to an abdication by academics and educationalists of their obligations to provide an educational direction for Management Education.

Beer, S.(1970) in his report on "The Organisation of the Manchester Business School from Nineteen Seventy", pointed out, among other things, "At MBS (Manchester Business School) we might say: our objective is to improve the quality of management. Can we imagine a Business School seeking to depress it? It is hardly worth our saying".

"I am arguing that Lord Franks set our objectives in the first place". "To exemplify what is explicit in his report a British Business School must provide courses both for men with some years of business experience and for men immediately or soon after graduation. It is probable that, as the school develops, it will spontaneously seek to provide a wider range of courses than these ...".

2:2 CYBERNETICS AND ITS RELEVANCE TO MANAGEMENT EDUCATION

Given the differences and limitations in both approaches: Groups A and B, there was a notable absence of purposefulness and a supportive system which provides the means to achieving measurable goals. Thus, in order to have

an adequate understanding of the aims of a management educational scheme, and whether the aims have been achieved or not, it is necessary for the head of the business school or department of management studies or program director of the scheme to decide what he wishes the management educational scheme to accomplish.

Broad well-meaning statements do not constitute a scheme for Management Education. A scheme is a curriculum, which consists of the different forms of knowledge to be taught; the arrangements of the segments of the contents; the teaching and learning systems; the methods of assessments and the supportive, operational and resource systems connected to the scheme.

Cybernetics provides the philosophy and mechanisms for purposefulness and purposeful behaviour which are directly relevant to:

- a) curricula design for Management Education, and
- b) the content of Management.

Purposefulness refers to teleology and that aspect of behaviour which shows "why" the behaviour of a system or individual is displaying certain actions having regard to the existence of an extrinsic purpose and a changeable environment. Purposefulness also includes the formulation of a system to answer "what if" questions where it is designed as a strategy for adaptive behaviour.

Behaviour is a way in which an entity acts or works. Purposeful behaviour is an intentional action by an entity which is directed towards a goal or a final state, interpreted as the purpose.

According to Rosenblueth, Wiener and Bigelow (1943), there are two categories of purposeful behaviour: non-predictive and predictive (extrapolative).

Non-predictive is one where the organism "merely follow" the source to which it reacts. A predictive behaviour is one which an animal or machine or entity predicts or extrapolates a future position to reach a goal, e.g the cat does not merely follow, but extrapolates its future position to catch a mouse.

Rosenblueth, Wiener and Bigelow (1943) restricted "teleology" by "applying this designation only to purposeful reactions which are controlled by the error of reaction i.e by the difference between the state of the behaving object at any time and the final state interpreted as the purpose. Teleological behaviour thus becomes synonymous with behaviour controlled by negative feed-back, and gains therefore in precision by a sufficiently restricted connotation".

Although the paper on, "Behaviour, Purpose and Teleology" by Rosenblueth, Wiener and Bigelow (1943) had addressed their attention to the animal and the machine, the notion of purposeful behaviour has been extended to social systems including business enterprises. In so doing a distinction must be made between purposeful behaviour of a machine system and purposeful behaviour of human beings and social systems.

Purposeful behaviour of a machine system has an inherent function which is a necessary condition of its goal. For example, in a thermostatic system whose function is to

maintain a constant temperature which is prescribed by the designer of the system. Also, with a guided surface to air missile, the system behaves in a certain way — according to the command guidance that controls it from the launcher, which is done either by radio or a lock-on radar/ computer system on the launcher — designed to hit a target i.e an aeroplane, which is the purpose of the system.

The two systems in the above example are different in complexity and in nature. The first system is a relatively simple one and it changes its behaviour after a change in the temperature has taken place either above or below a specified limit. Thus the thermostat system accomplishes its purpose by changing its behaviour when the environment changes. It also displays two types of behaviour and only one in a given environment.

The second system (a guided surface to air missile) is more complex than the thermostatic system in that it uses a predictor and extrapolates a phase-space relationship to hit the moving aeroplane. It displays more than two types of behaviour in different environments before it accomplishes its purpose.

Though these two systems are so different there exists an inherent function in both of them that is directly connected to, or a necessary condition of their purpose.

2:2.1 THE RELEVANCE OF PURPOSEFUL BEHAVIOUR TO TEACHING SYSTEMS

When applied to a teaching system or an organizational system, purposeful behaviour extends beyond the intrinsic function of a system. Thus if an observer is resident outside any of these systems and is trying to observe the purpose of such a system then the purpose may be said to be a property of the observer depending on his knowledge of that system. However, when designing a teaching system or an organizational system the purpose of any of these systems should be specified if we are to know whether the rules and functions of the behaviour-space or phase space are valid. Although it can be argued that both of these activities could be performed by the same person, nevertheless the two activities are different.

Another important factor to consider is that of purposeful behaviour of adult students in a teaching/learning situation. Here purposeful behaviour may be observed after sufficient duration is spent observing and correlating certain responses with respect to the goal of that situation.

The environment of a teaching system is not so fixed as that of a machine system, but it should be specified. That is to say, when we refer to the teaching/learning environment we must specify whether we are referring to the physical, administrative and/or psychological surroundings which are acting on the teaching/learning situation.

In certain machine systems, the environment can be reproduced but this could not be done in a teaching/learning situation. The reason is that the environment in a teaching

system has very dynamic components which can be accurately described linguistically as the "same type" of environment, but not "same" in the sense of having symmetric relation of one teaching situation with another.

The reasons for adopting certain strategies constitute a key factor in understanding purposeful behaviour in the light of adults students.

In examining the reasons (why) adults students have adopted different strategies to accomplish a specified purpose, the writer has found, that from three groups of { 30 } { 60 } and { 42 } students, 83 per cent, 68 per cent, and 76 per cent respectively of these students have been dominantly influenced by other factors than by logical reasons when tackling a complex task or a genuine real-life case study. These factors are:

- (i) A set of belief operators which the student applies under execution. The matter of belief in adult students should not be under-estimated, it is a state of mind which represents "the association, through experience of the activating stimulus state, with a means-outcome". According to George, F.H.(1973), "Activating Stimulus State" is "that state of the central nervous system which is capable of transforming specific beliefs into expectancies";
- (ii) an hedonistic principle;

- (iii) a principle of maximum returns;
- (iv) a strategy of minimum acceptable return now and maximum return later — growth strategy; and
- (v) covert motives.

It should be noted that these factors are very relevant to the type of students, (management students, training officers, technologists, teachers and educational students) that this work is concerned with. It does not claim that the same degree of belief systems exist for groups of children 0 - 5, 0 - 7 years of age or for the category of studies, called "special education".

2:3 PROPOSED OBJECTIVES FOR A MANAGEMENT
EDUCATIONAL SCHEME, AND A DEVELOPMENT
OF THE DISCIPLINE OF MANAGEMENT

A management educational scheme should have at least two main objectives.

The first objective is the initiation of students into a body of knowledge and experience made public and which can be used as a point of reference to prepare future managers. This implies that Management Education should be taught as a "discipline", which permits growth and change of structure but with a professional outlook.

Etymologically, the word "discipline" is derived from the latin word discere, to learn, and discipulus, a disciple, that is one who learns from another, a teacher.

A "discipline" contains a body of teachable knowledge with its own background of literature and experiences; its own distinctive public criteria, conceptual framework, procedures, methods and content area, from which a communicating community of men and women may be initiated into. The body of knowledge and experience made public on the principles and practice of Management are sufficient to support the contention that Management is a discipline, and therefore Management Education should have as one of its strategies the need to provide professional training for future managers in the knowledge and skills necessary to practise Management. Management also has a history and a heritage of literature.

Very briefly, the literatures may be categorised in the following manner.

2:3.1 CORPORATE DEVELOPMENT

The Companies Act, 1856, together with subsequent enactments have modified the rules relating to business enterprises, and have extended very greatly the legal provisions which are made in connection with the Management of business enterprises.

Today, managers of Limited Companies must keep in mind statutory obligations now contained in the Companies Act 1948 (which has consolidated all previous company legislation) and Company Act, 1967. This kind of enterprise has become a major economic and social unit in our society. It has also become increasingly detached in personal terms from its owners and is concerned with its own continuity and self perpetuation.

The events following the creation of the Limited Liability Companies have led to the emergence of the professional type manager. In support of this development was to follow by the establishment of professional institutes:

- the Institute of Chartered Accountants in England and Wales and in Scotland by the Royal Charter;
- the Association of Certified and Corporate Accountants;
- the Chartered Institute of Secretaries;
- the Institute of Cost and Works Accountants (with effect from 2nd March, 1972, the name of this institute was changed to "Institute of Cost and Management Accountant") and,

the British Institute of Management, which was established in 1947 and whose aim is "to promote the highest professional standards of management in every sector of the economy both at organisational and personal level".

The BIM is the central national source for information on management policies, practices and techniques; and on management development including education and training.

2:3.2 ORGANISATIONAL STUDIES

The intention to develop organisational studies in a systematic way, so that students who had not been born into a privileged family could acquire knowledge of organisation and administration through training and education was made public by Henri Fayol.

Fayol rejected the view that managerial ability could be acquired only in business practice and developed his analysis of the process of Management.

Fayol, according to Storr's, C. (1949) translation, analysed Management into five elements:

- (i) prévoir (forecast),
- (ii) organising,
- (iii) command,
- (iv) co-ordination, and
- (v) control.

He contended that attention to these elements would contribute to better efficiency in a business enterprise.

(i) PREVOIR:

On prēvoir — to plan — Fayol includes "Gouverner c'est prēvoir", "to govern is to foresee" as an essential pre-requisite to the process of Management.

(ii) ORGANISING:

On organising, Fayol contended that a business enterprise needs a structure in which authority, decisions and tasks may be effected.

Fayol developed the notion of hierarchie which was translated as "scalar chain" of superiors ranging from the ultimate (pyramidal) authority to the lowest ranks.

The "scalar chain" constitutes the process of co-ordination through which the supreme co-ordinating authority becomes effective through the entire structure.

Fayol's line of authority may be represented by the hierarchical structure to be found in the army, air-force and navy where the communication channels are dominantly vertical. With such a structure, messages are transmitted upwards through immediate superiors to ultimate authority while commands or orders flow downwards in opposite direction to the lowest rank.

Fayol listed sixteen managerial duties as important pre-requisites for success in organising. These were:

1. Ensure that a plan is judiciously prepared and strictly carried out.
2. Ensure that the human and material resources are consistent with the objectives of the organisation.
3. Develop a single guiding authority which should be energetic and competent.
4. Formulate clear, distinct and precise decisions.
5. Bring together in an agreeable manner those activities implied by the organisation structure and co-ordinate the efforts of the employees with them.
6. Draw up a method of efficient selection where each department must be headed by a competent and energetic person, and each employee should be in that position where he or she can render the greatest service to the enterprise.
7. Make certain that the duties of the employees are clearly defined.
8. Relate responsibility with initiative.
9. Establish payment scheme of fair rewards for services rendered.
10. Employ appropriate sanctions resulting from drop in quality, or deviations from standard or serious errors.
11. Ensure that discipline is maintained.
12. Organise individual interests so that they are subordinated to the general interest of the

enterprise.

13. Special attention should be given to the notion of unity of command.
14. Materials and human resources should be supervised.
15. All the resources within the business enterprise should be controllable.
16. Fight against excess regulations, red tape and paper control.

(iii) **COMMAND:** On command, Fayol insisted on the notion of unity of command, that is, for any action whatever, an employee should receive orders from one supervisor only. In this respect, the superior should set a good example by fostering loyalty, and directing his energy also to the notion of unity of command.

(iv) **CO-ORDINATION:** Fayol developed his notion of co-ordination from the organisation structure and the "scalar chain". He contended that co-ordination across the organisation should be effected by weekly conference of departmental heads, and each department should work in harmony with other departments.

(v) **CONTROL:** Fayol's ideas on control were largely within the framework of the organisational structure and his notion of unity of command. He suggested periodic management audit using summarised charts to aid the process of control. He also recognised that if control is to be effective it must be done within a reasonable time and be followed up by sanctions.

Fayol admits that there are certain dangers in paper control, especially in large enterprises (public and private) and included as his sixteen managerial duty "fight against excess regulation, red tape and paper control".

Fayol's contribution to management thinking is of considerable value, although in present-day situation where society is changing at a rapid rate, we may see a number of redundancies in a number of his ideas and his list of managerial duties for success in organising. His five elements were acknowledged by many well known writers on Management and Administration, notably writers like Mary Parker Follett (1941), Urwick, L (1947), Herbert Simon (1957) Brech, E.F.L. (1966) and others.

Brech, E.F.L. (1966) in "The Principles and Practice of Management" re-classified Fayol's five elements of Management in the following ways:

"planning - to prepare the necessary information and to interpret it into programmes; to establish appropriate organisation, layout, methods, instructions, etc., thus to provide the basis for decision leading to action.

command - to initiate action by communicating decision, to keep it in progress, and to supervise performance, while ensuring a high level of co-operative participation as the outcome of good morale.

co-ordinate - to keep all activities in balance and in suitable combination.

control - to review results, to record as necessary, to judge performance and cost, and to feed back as the guide to planning (or command = decision)".

Subsequent concepts and theories were developed by the above writers having sprung from Fayol's contribution.

FUNCTIONAL PROSPECT

The functional prospect emerges from a practical arrangement of sub-dividing the elements of Management into sets of functional activities by a great number of industrial and commercial enterprises in Europe and North America.

The usual sets of functional activities are subdivided in the following ways:

(i) Marketing - activities concerning market research, marketing research and intelligence, advertising, distribution and consumers behaviour and orientation.

(ii) Personnel - activities requiring manpower including manpower planning, selection, placements, promotion, training industrial relations and welfare.

(iii) Finance - activities concerned with maintaining proper financial records, reflecting fair view of accounts, steering and controlling the business enterprise through the various legal and financial requirements, planning for long-term and medium-term growth, providing working capital and

helping to make the enterprise viable.

(iv) Production - activities concerned with planning, scheduling, controlling and specifying production standards, volumes, and actually producing the products.

2:3.3 EMPIRICAL AND TASK MEASUREMENT APPROACH TO MANAGEMENT

An empirical form of knowledge concerning task measurement and method study was introduced during the late nineteenth and early twentieth centuries, by two well known thinkers, (i) Frederick Winslow Taylor and (ii) Frank Bunker Gilbreth whose hypotheses were testable by observations and experience.

(i) Taylor, F.W. according to Copley, F.B. (1928) is the "Father of Scientific Management". Taylor's empirical form of approach became popular after his work at the Midvale Steel Company at Philadelphia in the United States of America, about 1880. Taylor, who was a chief engineer with the Midvale Steel Company made a detailed study of the actual methods of work that were being used, by workmen loading pig-iron onto a railway-waggon in the course of a normal day's work.

Taylor analysed the method of work in detail and devised a better method for handling pig-iron than the observed method. His method was to analyse the job into different phases and determine how long a handler should remain under load, when he should rest; for what period the

rest should be, and a well timed program for a day.

He with the aid of his assistants selected a group of handlers, which they felt were more suitable for the job, and subjected them to Taylor's method supported by a substantial earning incentive from an average of \$1.15¢ to \$1.85¢ per day.

Taylor's method of handling pig-iron had resulted into a substantial increase in handling from an average of 12.5 tons to approximately 47 tons per day.

Taylor later developed four principles which he summarised as follows:

- "1. Management must develop a science for each element of a man's work, which replaces the old rule-of-thumb method.
2. They scientifically select and then train, teach and develop the workman, whereas in the past he chose his own work and trained himself as best he could.
3. They heartily co-operate with the men so as to ensure all of the work being in accordance with the principles of the science which has been developed.
4. There is an almost equal division of work and the responsibility between the management and the workmen. The management takes over all the work for which they are better fitted than the workmen, whilst in the past almost all the work and the greater part of the responsibility were thrown upon the men".

While present-day situations show that workers in Great Britain are more powerful today than in the late nineteenth and early twentieth centuries and they are not influenced only by earning incentive, Taylor's work is regarded as the foundation of management science, and industrial engineering.

(ii) Frank Bunker Gilbreth was a contemporary of Taylor and developed a program for motion study for such tasks as bricklaying, cinematography and industrial engineering.

In the bricklaying study for which he became famous Gilbreth observed, that the work of the bricklayer involves bending down to pick up a brick, and inspecting it for quality and appearance then bending down again to pick up a trowelful of plaster then spreading the plaster then positioning the bricks and so on.

Gilbreth analysed bricklaying into eighteen different motions and ascribed symbols or codes for each element, thus making the analysis conducive to rapid recording and relatively accurate identification of each motion. He named this part of his study "therbligs" derived from the alphabetic symbols of Gilbreth with an 's' added. Here is an exhibit of his analysis.













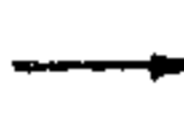



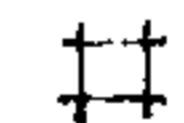

<u>ACTION</u>	<u>SYMBOL</u>	<u>IDENTIFYING COLOUR</u>
Search		Black
Find		Grey
Select		Light grey
Transport empty		Light green
Transport loaded		Dark green
Grasp		Dark red
Release load		Light red
Position		Dark blue
Pre-position	 (skittle)	Light blue
Use		Purple
Assemble		Dark violet
Dis-assemble		Light violet
Rest		Orange
Inspect		Light brown
Plan		Dark brown
Avoidable delay		Light yellow
Unavoidable delay		Dark yellow
Hold		Gold

FIG. 1. List of Therbligs.

Gilbreth having studied the eighteen motions of the task carefully, perceived that there was a lot of wasted energy in brick-laying which could be successfully reduced without excessive strain or undue physical demands from the bricklayers. He then proceeded to eliminate the unproductive motions, such as the bending down of the body to pick up the bricks and the plaster from the ground level until they were reduced to five essential motions. These were:

- (i) operations,
- (ii) transportation,
- (iii) inspection,
- (iv) storage, and
- (v) delay

Gilbreth then assigned separate groups of workers to different tasks connected to the five elements. Some workers had to position everything the bricklayers required at waist-level, while others would transport the bricks and do other limited tasks directly related to the five elements.

In quantitative terms his new approach to brick-laying had led to a substantial increase in performance from 120 bricks per hour to 300 bricks per man hour.

Gilbreth's work provided a foundation for industrial and systems engineering.

2:3.4 HUMAN RELATIONS

The notion that employees attitudes could influence their output of work took many years of research and debate before it was accepted by Management, with reservations. An attitude — a pre-disposition to form certain opinions and influence other opinions and behaviour — may be formed by a group of employees on a particular job or process, which if positive, can result into increase output by that group of employees. If the attitude is negative or indifferent then that group may influence individual members in different ways to conform to a norm — rate of output — tacitly fixed, which he or she will be advised not to exceed. This type of group is not identical to a representative group of a trade union, which may be accepted as an approved group by Management. Instead, it is a work-team which Brown, J.A.C. (1954), calls a "primary or face to face group".

The attitudes of a working group and its ability to impose an informal restriction on their rate of output, were revealed to Management as a result of research carried out by Elton Mayo. Mayo's research was carried out at the Hawthorn Plant of the Western Electric Company of Chicago in the United States of America, between 1924 to 1933.

Mayo who had been influenced by the empirical approach of Taylor, F.W. was commissioned to enquire into the total human situation. His two main terms of reference were:

- (i) to examine the influence of illumination upon the level of output; and some years later

- (ii) to investigate the social pattern of groups of employees working on certain operations.

With the first investigation, Mayo used principally two groups of operators in a light industrial section of the Western Electric Company for his study. The first group of operators worked in an environment where the intensity of illumination in the working area was increased and improved upon. While the second group of operators worked in the existing environment where the illuminative density remained constant.

Mayo contended that appreciable increases in the rate of production by both groups were recorded and that the difference in rates of production between the two groups of operators was marginal. "We were again unable to determine what definite part improvement in performance should be ascribed to improved illumination". Mayo, E.(1933).

Mayo attributed the increase in the rates of production to a "betterment of morale than to any other". He noted a significant change in attitude by the operators which he accredited to an apparent show of personal interest, friendliness and non-adherent commitment by the investigators to the departmental head. The indeterminate conclusion of the first investigation led to a second investigation.

In the second investigation, Mayo and his investigators' attention "had been drawn to the fact that social groups in shop departments were capable of exercising very strong control over the work behaviour of their individual members", Mayo E. (1933).

Mayo observed that in spite of financial incentives some social groups of operators were restricting their outputs even though they were capable of producing more. He observed that a group may build its own norms — some expressed verbally, others implicit in action — and these norms may include the setting of a tacitly agreed standard in terms of a certain amount of units, say between 6,000 and 6,020 each day, no more, no less, although they are capable of producing 7,000 units.

Further research on the ways which such primary groups may influence the behaviour of their members, has been carried out by Wilensky, H. (1957), "Human Relations in the Workplace: An appraisal of Some Recent Research", and others. Also, the knowledge that social needs of an individual — belonging to a working group — could be more important than an extra cash reward has led to popular concern in the 1950^s and onwards for human relations in Management. Such popular concern for human relations in Management may account for the notable rise of interest in the study of social and industrial psychology in the 1950^s and 1960^s.

2:3.5 QUANTITATIVE ANALYSIS AND OPERATIONAL RESEARCH TECHNIQUES IN MANAGEMENT

Notable advances in quantitative analysis in Management came during the second world war, as a result of some quantitative thinking by a mixed team consisting of scientists, operational men and military advisors.

This type of thinking and the use of quantitative analysis were applied not only to the technical side — improved weaponry and communication — but to the organisation of men and their weapons in military operations, and for strategic and tactical decisions. The body of knowledge gained from these situations was later developed as a field of discipline called operational research or operations research in the United States of America.

Senior members of the operational research society of Great Britain have contended that P.M.S. Blackett (the late Lord Blackett) was an outstanding person in instrumenting operational research as a field of discipline. Apparently, this was due to his appointment in 1941 as personal scientific adviser to the air officer commander-in-chief of coastal command, and as head of a mixed team of problem-solvers, which he called the operational research section.

The stages of quantitative analysis which he and his team used were:

1. Prepare and study statements of the problem, usually a term of reference is drafted.

This may require them to study and prepare a plan, say for protecting a merchant fleet from being sunk by U-boats. This would involve keeping away U-boats from the merchant fleet by actually sinking or destroying them.

2. Collection of data. Operational staff provided the team with relevant data - combat reports and performance information, and an operational outlook.

3. The data is then sorted out and analysed to produce a hypothesis.
4. The hypothesis is then used as a model of a plan to sink and destroy U-boats.
5. Actual data and monitoring of the actual performance against plans were checked to see whether particular courses of action were in practice bringing about the effects expected.
6. Records of the results of past operations under known conditions were kept and used to predict the result of a future operation under new conditions.

Blackett and his team became successful in devising a strategy for attacking U-boats which resulted in an increase between 2 to 20 per cent of visible U-boats actually sunk.

As the United States of America entered the second world war the use of quantitative analysis became a method for formulating strategic and tactical decisions for allied troop operations.

Another important form of quantitative knowledge gained was the application of probability theory to strategic and tactical decisions, which gave strength to the stages of quantitative analysis outlined above, and became an essential part of the domain of knowledge called operational research.

2:3.6 CYBERNETIC STUDIES OF HUMAN ORGANIZATION AND MANAGEMENT

Problems of human organisation were associated with the field of Cybernetics in its early stages of development. According to Wiener, N. (1961), for "problems of human organization, we sought help from the antropologists Drs. Bateson and Margaret Mead; while Dr. Morgenstern of the Institute of Advanced Study was our adviser in the significant field of social organisation belonging to economic theory. His very important joint book on games with Dr. von Neumann, by the way, represents a most interesting study of social organisation from the point of view of methods closely related to, although distinct from, the subject matter of cybernetics".

Cybernetics ideas and concepts were used to analyse industrial and business organisations ever since the development of this field of discipline in 1943 - 44. Deutsch, K.W. (1952), "On Communication Models in the Social Sciences", used Cybernetic concepts and ideas to analyse industrial and business organizations with special emphasis on the implications of communications models for the evaluation of organizational behaviour.

Beer, S. (1956), "Operational Research and Cybernetics", used Cybernetics in the context of analysis and modelling a cybernetic organisation.

C. West Churchman, Russell L. Ackoff, and E. Leonard Arnoff (1957) in "Introduction to Operations Research" used Cybernetic concepts and ideas as a basis for "Analysis of the Organization".

Subsequent publications including "Cybernetics and Management" by Beer, S. (1959) were made available to the public but in spite of the worthwhile body of public knowledge on Cybernetics, many universities and educational institutions which offer management educational programs at the post-graduate level still continue to neglect and exclude Cybernetics from their curricula.

A business enterprise is a purposeful entity which has become a major economic and social unit in our society. It has also become increasingly detached in personal terms from its owner, and is concerned with its own continuity and self-perpetuation. A business enterprise is an artificial creature different from the machine system, as it derives its capacity from the Statutes under which it is incorporated, e.g the Companies Acts 1948-1967. Under section 5 (1) of the 1948 Act, headed "Memorandum of Association", an enterprise (company) "may by Special Resolution alter its objects so far as may be required to enable it to achieve the purposes specified" in a changing environment.

The organisation of a business enterprise is a communication network, which is effected by managers, each possessing his or her own physiological and psychological characteristics and own "Weltanschauung", but bound with others by agreement to constitute the "management" of the enterprise.

A business enterprise displays purposeful behaviour, it can change its purpose, which is usually self-initiated, over a period of time, say five years or more, from merely existing with a profitable return on investment to growth,

by reducing current earnings through investing in growth-creating areas such as Research and Development (R and D) and marketing.

A business enterprise has two main types of environment: internal and external. The internal environment consists of the physiological properties and associated constraints.

The external environment consists of forces that act on the entity, but which are beyond the direct control of the entity itself. These forces are:

- (a) the economic state of the industry within which the entity exists, i.e general drop in demand for certain types of products;
- (b) population change which has serious consequences in attracting manpower as well as in the marketing of products;
- (c) government policies on such things as wage restraint and tax on profits;
- (d) political and social problems;
- (e) technological development in production techniques and information processing;
- (f) competitors position of the market and strategic moves;
- (g) financial position in terms of rate of interest and money policy by the banks, and
- (h) other problems including supplies of materials and inputs.

A business enterprise may display changing behaviour to meet changing environment.

The management of a business enterprise may devise plans and strategies for enabling the entity to accomplish its purpose. For example, decisions for growth involve reducing current profits but in the long run increasing the capacity to earn profits at a later period.

A business enterprise is capable of resuming a steady state after it has been disturbed in a way not envisaged by management. This state of affairs is called ultra-stability.

Some business enterprises are capable of changing an environment in order to achieve its purpose i.e some large corporations and international corporations such as Hiltons Incorporated and ITT.

The management of a business enterprise can commission the installation of a Management Information System that will produce messages which will "inform", "instruct" and "motivate" its management to steer the entity towards a desired purpose. To do so management needs to know what has happened, is happening, and what may happen to the entity. The MIS may provide a computer simulation of what is likely to occur. Such as "what if" competitor "y" reduces the price of a particular product by 10 per cent in a declining market which our entity is trading? "What if" our leading product reaches the saturation stage of its life cycle earlier than predicted do we prepare a set of ideas for new product development or take over a competitor or diversify? Diversification involves a departure from familiar familiar product to unfamiliar market; or entry into new product lines involving design, and production technologies, and usually types of market that are new to the diversifying

4

enterprise, what does a risk amounts to?

The answers to these types of questions may be simulated and if necessary, games to defeat our competitors can be formulated or/and games to outwit competitors and larger corporations who may be seeking to acquire or gain a controlling interest in our enterprise.

The second objective of a management educational scheme is to provide certain essential forms of knowledge which are intended to enable students to develop beyond their vocational abilities and adapt to changing conditions not withstanding, at least, an acceptable standard of competency in Management.

3. SOME PROBLEMS IN ASSIGNING MANAGEMENT INTO THE TRADITIONAL CATEGORIES OF KNOWLEDGE

If society is to accept Management as a worthwhile profession in an era marked by technology in communication, technology in organisation and technology of methods then the educational curricula for Management must contain essential forms of knowledge which are relevant to achieving their objectives regardless of institutional categorization of knowledge. Thus, the simple division into arts and science, while appealing to the popular minds, is out of date, when applied to Management Education.

This division reflects an era of the nineteenth century educational reformers, who were urging that science be accepted into the curricula of universities because at that time, the curricula were dominated by theology, metaphysics, classics and literature, which they termed arts. The reformers main intention was to have a "liberal education" by which they meant an education with a proper balance between the arts and the (natural) science. Since then many universities have structured their educational administration on arts and science "cultures" supported by budgetary division which place strict boundaries around the educational activities of each faculty or department. For example, funds allocated for educational programs, staff, space and resources having to come within either the dean or head of arts or dean or head of science. This state of affairs has an affect of excluding programs which do not come within an administrative definition of either arts or science.

Also, this division encourages sub-departments in arts and science, (to a greater extent in the arts than the science) to append un-co-ordinated bits of new knowledge to old programs with a tendency to give old programs or schemes new titles.

The dichotomy between arts and science has been expanded to a trichotomous categorization of knowledge into: arts, science and social sciences.

The social sciences as a separate category became popular with the upsurge of economic and social theories in the first quarter of the twentieth century. These theories contained some empirical generalization, largely of a statistical nature, on historical events, social functions and human intentions.

The second quarter of the twentieth century was marked by the application of quantitative methods to organisational and social functions, human intentions and the growth of technology as a result of a number of purposeful activities during the second world war. The success of those purposeful activities is partly due to a re-organisation of knowledge from separate compartments into interdisciplinary study by groups of participants having a material interest in a problem or issue or a task. Such a group may consist of persons trained in specialist fields within the arts, the science, and social sciences which are organised into a common effort on a problem with continuous intercommunication among the participants. The knowledge — concepts, methodologies, terminology and philosophy — gained have resulted into another category of organisation of knowledge, called interdisciplinary science.

In addition to common effort and continuous intercommunication among the participants as outlined in the above paragraph there should be at least an intersection in a material field of interest to the participants of other disciplines as a minimum property of interdisciplinarity. Cybernetics provides an example, where the study of purposeful behaviour, and the study of the mechanisms of control and communication in the animal, the machine and social systems, have resulted into an interdisciplinary science.

Two subjects may also be hybridized into an interdisciplinary science. For instance, some integration in theories and methods have been made between biology and physics thereby creating biophysics; chemistry and biology thereby creating biochemistry; and many others. However, in spite of the development of interdisciplinary sciences and fields of discipline which focus attention on technology and the application of knowledge to real-life problems the trichotomous categorization of knowledge into: arts, science and the social sciences still seems popular with those universities and educational institutions, which either acquired their charter in the 1960^s or expanded their activities around that period. In many cases Management is assigned to a category called the social sciences, although there is no general agreement as to what forms of knowledge constitute the social sciences or as to a set of rules indicating how the boundaries are drawn to define the social sciences, at the exclusion of arts, and science. For example, at the universities of Edinburgh and Kent, Management is in

52

the category of social sciences; at the university of Salford, Management is in the department of "sociology, government and administration"; and at the universities of Leeds and Lancaster, Management is in the category of arts.

Thus, the categorization of knowledge into separate compartment such as arts, science and social sciences is unhelpful when applied to Management. The reason being that the base for building an adaptive management educational scheme contains certain essential elements within the forms of knowledge which make up the scheme that cut across the three categories: arts, science and the social sciences.

The elements are:

(i) Empircism.

This requires those forms of knowledge in which ideas are testable by observation and experience. This would includes ideas about a population, its dispersion, and its psychological make up in relation to the purchase of a product. This element should be present in other productive and strategic aspects of Management. Experience in this sense covers facts which are data of immediate and direct knowledge, facts about material objects, physical events or sensation and other experiences.

(ii) The logics of reasoning.

This involves knowledge of the relation between definite numbers and analytical and deductive forms of knowledge in which relations are usually expressed symbolically. The logic of reasoning also includes not only

knowledge from empirical evidence as in (i) above, but from inductive generalization and sets of hypotheses which have not been refuted by experience. Inductive reasoning would include the reasonableness of belief in the premises of an argument, and heuristic models.

(iii) Communication.

This will involve the nature and value of human communication, and analytical communication studies.

(iv) Social developments and events.

This includes an understanding of the law regarding the rules of a business and knowledge about the economy and policies of the government, and

(v) Morals.

The need for a person to act on reasons which include respect for others. This form of knowledge involves the type of knowledge pertaining to the likely consequences of one's actions and those of others. These are often found in rules, codes and principles that a large number of human beings have found compelling. According to the Hon. Sir Patrick Devlin (1959) "Society cannot live without morals. Its morals are those standards of conduct which the reasonable man approves".

A rational man is said to be good by society standards, but he may have other standards. If he has no standards at all he is not a rational man, and need not be further considered in this thesis, except to say, that

Statutory Laws may be introduced on the principle that "there ought to be a law against" those who have no standards in respect of a set of moral codes.

On these five essential elements rest the ways of thinking, the ways of doing, and technology then at another level is purposefulness. It is within this context that the content of a management educational scheme should be designed.

4. EMPLOYING THE MECHANISMS OF CONTROL FOR DESIGNING AN EDUCATIONAL SYSTEM

The mechanisms of control and communication make up the essential forms of knowledge under the field of discipline called Cybernetics. This aspect of the research employs the important mechanisms of control to:

- (a) the educational curricula of Management Education; and
- (b) the science of teaching and other supportive systems for translating the objectives of a management educational scheme into goal directed actions in the teaching/learning situation.

The important mechanisms of control that are relevant to an educational system are:

- (1) change;
 - (2) stability; and
 - (3) regulation, and associated with all of these mechanisms is the important notion of variety.
- These mechanisms are at the root of the normative aspect of this research, which advocates cybernetic concepts and principles for designing a management educational scheme. These mechanisms of control are described here-under.

4:1 CHANGE

Change occurs continuously in all animals, machines, people and systems by an infinitesimal (smaller than an assignable) quantity. In employing cybernetic concepts and principles to the nature of change, it is necessary to study the notion of transition which occurs when a system changes from one state to another state.

Transitions in the states of very large economic, governmental, industrial and social systems occur with profound effect on society. For example, the nature of the economic, industrial and social transitions which took place in the United Kingdom after the second world war has still left behind the traditional school of planners and controllers who depended a great deal on economic theory and governmental sanctions and penalties for planning change. This has given rise to much confusion in post-war planning.

Beer, S.(1975) in his book, "Platform for Change", has offered Cybernetics with the hope that "something may yet be done" by those who are capable of using science in understanding the "Laws of Change".

The economic, industrial and social transformation that is taking place in the United Kingdom requires structural changes in the operation of many systems, including those educational systems developed for Management Education at many universities and institutions of higher education.

In education, a transition occurs when an operator or a set of operators (a curriculum, a teacher and teaching systems, and external environmental factors) act on an operand

(a student) and bring about a change. In this terminology the changed student is the transform.

The transformation process on the operands (students) from the point of entry on a scheme to the completion of it is not well structured or precise as the kind of well defined process which a technologist would expect to find on a specification to produce a metallurgical product. Instead, the students' behaviour is monitored through a number of transition states or vectors over a time span, usually a university calender or organizational time span.

In this thesis the transition states or vectors are represented by a set of integrated "modules". A transition is assumed to take place when a student having completed a "module" and performed satisfactorily in the assignments relating to that "module". The term satisfactory is defined later on in this section.

There is no known determinate proportion of learning in each transition vector in an educational scheme, although different weights may be apportioned to some "modules" in a set of integrated "modules" or to some subjects as against others in a traditional course program. However, as a result of practical experience and hindsight after studying the performance of over 100 students from different educational schemes over the past two years, a rule of synergism appears to apply to the transformation process of learning, particularly in the case of Management Education.

Rule of synergism. Given two equally motivated students:

S_a and S_b

Given a terminal vector T^6

Synergy may occur in S_a , if or when he integrates any two or more of the following vectors: T^1 , T^2 , T^3 , T^4 , and T^5 efficiently, such that increase in intensity of learning is gained. This may result in S_a being able to meet the terminal objective in less than or equal to the minimum program time, or showing greater potential at the average program time than if the other student, S_b , had not made any efficient integration of the preceding vectors. The program time is the duration of the scheme. Thus synergy may be acceptable as a rule for change or as a means of facilitating change.

THE STATES OF A SYSTEM AND THEIR MEANING

The oxford dictionary defines a "system" as "complex whole, set of connected things or parts, organised body of material or immaterial things". Many people often use the term system in this way. When used in this way, the term system does not convey a definite conception of what a system is, and how it can be controlled.

A system is a set of inter-related elements which have a regular relation that holds them together as an identifiable entity.

By a state is meant the relevant properties which a system has at a particular time that are of value to an observer or alternatively to the purpose of the system. A well defined condition of the relevant properties at a

particular time that can be recognised, if it occurs again may be called a state. In some cases, a person may be interested only in two states, off and on, fail or pass. But a cybernetician may be interested in a larger number than two states. Moreover, some states may be represented by vectors, i.e a purposeful set of "modules" in an educational scheme.

If an observer is studying a whole system, say a missile system or a man/machine system, or a corporate system or an educational system, he would be required to specify the key functions and the variables of the whole system. Such specificity though incomplete may constitute a minimum acceptable representation of a whole system, although a whole system may be a system of systems and have sub-systems. A change in the behaviour of any of these whole systems normally take a longer time to observe than in a study of a sub-system.

Another observer may be concerned with studying a sub-system of any of the previous systems which he may see as a whole system with further sub-systems. For example, he may be interested in the learning system of a student and elect to study the cognitive functions of the student in relation to a set of specific tasks. In this respect, he may select a set of variables, functions and states from a variety of such items which are actually available to represent the real student. Thus a system is here defined as a particular set of variables, functions and states with which the observer is concerned.

Another way in which the term system may be used is to present an actual system in terms of all the elements,

6

functions, sub-systems and the regular relations that make a whole system what it is, or the actual form of it in existence. This usage is acceptable by designers and engineers, quite apart from any observer studying the system.

4:1.2 CHANGE AND CONTROL

However, when considering change as a mechanism of control, certain essential requirements must be met.

These are as follows:

- (a) any individual or device or group of individuals who wish to control a system must have access to the variables and functions of the system;
- (b) they should have the ability (by having authority, or by employing or designing appropriate operators) to influence the behaviour of the system; and
- (c) they should be able to select a particular state or vector and determine its value in achieving the control task.

4:2 STABILITY: AND ITS MEANING

Stability is an important mechanism of control. It involves the maintenance of an equilibrium in a system, after displacement and consequent oscillation dying away through the dissipation of energy. The equilibrium is a representative point or a region on the behaviour space of the system which a system seeks to maintain in spite of disturbances for its survival or its efficient operation.

STABILITY AND THE CONCEPT OF HOMEOSTATIS

Mechanisms exist in many machines, for example a thermostat, which has the function of maintaining certain constant or equilibrial states. In the animal and the human being similar mechanisms exist and are generally referred to as homeostatic mechanisms.

The principles of "homeostatis" was put forward by Cannon, W.B.(1939) as a condition whereby co-ordinated physiological processes maintain the steady states in the body. These processes are in general complex, involving as they may the brain, nerves, heart, kidneys, spleen et cetera.

Ashby, W.R.(1960) contends that "adaptive behaviour is equivalent to the behaviour of a stable system, the region of the stability being the region of the phase-space in which all the essential variables lie within their normal limits".

Beer, S.(1972) extended the concept and principles of homeostatis to large industrial systems and to government. He defines homeostatis as "the capability of a system to hold its critical variables within physiological limits in the face of unexpected disturbance or perturbation".

Beer's extension and application of the concept of homeostatis may be regarded as a law of stability and change for business and industrial systems. But in spite of the development of this law, which offers great potential for understanding dynamic stability and change in a scientific way, its application is excluded from the curricula of over 90 per cent of educational institutions which provide master's degree programs in Management Education.

4:2.1 STABILITY AND THE DESIGN OF AN EDUCATIONAL SYSTEM

There are two important reasons why stability is necessary for the design of an educational system. The first reason is to achieve planned change from old ideas to new knowledge and technological developments. To effect such a planned change a university or educational institution may have to establish an "intelligence system" where teachers and researchers monitor and learn: (a) the different kinds of new knowledge, real-world problems and issues, and (b) modern efficient teaching methods and their systems with a view to changing an educational system which has no adaptive mechanism to one which has.

With such an "intelligence system", the adaptation may occur as a result of the following:

(1) after the teachers and researchers have learnt (a) and (b) which are described in the above paragraph, and in addition obtain an accurate knowledge of the imprecation of their educational system;

(2) devise a plan on how to eliminate or reduce the imprecations of the educational system to a minimum and to make it adaptive, and

(3) then activate (2), (the plan).

4:2.2 STABILITY AND SELF RENEWAL

The second reason why stability is important to an educational system is that there should be a dynamic equilibrium in the continuous process of self-renewal for progress. This concept of self-renewal recognizes the pressure for change in the economic, the social, the technological and the institutional domains of society. The strategy for progress in this situation is not similar to that for problem-solving, because with the latter, its activity ceases when the problem is solved or the expectancy is satisfied. But with self-renewal the strategy goes through a continuous process of profound self-renewal as educational system plays a more active role in society than at present. Such a role would involve the universities and educational institutions in re-designing their educational programs so that they can actively contribute to the directions of change. Also, by educating people in the design of society's systems, they (society's systems) can be controlled for the benefit of society.

4:2.3 STABILITY AND CURRICULA DEMANDS

A university or educational institution which is interested in working towards self-renewal, would need to use the concept of stability particularly in the area of curriculum design, in order to make planned progress. In this respect, a dynamic equilibrium region — an equilibrium region which changes over time in accordance with some corresponding change in the physiological limits of the system — would have to be maintained between at least three types of curricula demands.

The first type is that a curriculum should seek to provide a menu of broad and non-integrated courses where students are allowed to make-up their own set from the menu of courses available within a program to satisfy their wants.

While this type gives the students freedom to make-up their own set, there is the danger that some students may select courses which give them a broad education, but lack of sufficient technological and scientific knowledge to meet future changes in a modern society. A poor selection may give some students less chance of securing employment than others or similarly may present difficulties in integrating their set of knowledge with that for a professional training.

The second type is for the provision of a curriculum which is specifically designed to meet our industrial manpower requirements or professional demands. This kind of curriculum has the advantage of being very rewarding to the government and manpower planners. It also has immediate advantage to the student, in that after qualifying, a student has a relatively

easy entry into industry or immediate job prospects according to the economic demands.

However, this type of curriculum has a long-term structural disadvantage, in that the economic demands and the nature of technology change so rapidly that a trained person in 1970, may find himself becoming redundant by 1980 because the structure of the community needs change, or because of a very significant error in government planning, which usually is the case. Either of these factors can cause vacillation at a later age of a person's life thus making him worthwhile only to the demands of the day.

The third type is that a curriculum should be heavily oriented towards theoretical and synthetic knowledge with little or no pretence of having any commitment to real-world problems or current business practice. It should be concerned with providing a good intellectual and specialized knowledge of some kind that is of interest to the individual's wish. This type of curriculum has the advantage of concentrating on a narrow field, without having to worry about the problems of implementation. The content of this type of curriculum is usually reduced to further specialism which could be the basis for a good intellectual habit.

The main disadvantage of this type of curriculum is that it fails to come to grips with real-world problems and offers too many statistical or hypothetical theories which are of little use to solving practical or unstructured problems systematically.

Thus it is of paramount importance that the concept of stability is applied to the design and development of a set of

curricula which support a worthwhile management program. If not, imbalances will occur and students will be subject to all kinds of disturbances. A way of minimizing disturbances and maintaining control is to develop a regulating mechanism which is cybernetic in nature.

4:3 REGULATION AS A MECHANISM OF CONTROL

The word " regulation " has different meanings when applied to certain aspect of the management of a business or corporate enterprise, or an educational program offered by some universities, or when used in a field of discipline like Cybernetics.

To an executive director of a corporate enterprise, the word " regulation " refers to orders and authoritative guidance laid down by an Act of Parliament or a Statutory Instrument which are enforceable in a Court of Law. These regulations include Companies (Unregistered Companies) Regulation, 1967 (S1 1967 No1876); the Companies (Disclosure of Directors' Interests) (Exceptions) No 3 Regulations 1968 (S1 1968 No 1533); Regulations under Rule 224 of the Companies (Winding-up) Rules 1949, issued 7th May, 1965 and many others.

A characteristic of these regulations is that they are imposed by an authority from outside the corporate enterprise and are not used as mechanisms designed by the management of the enterprise for its efficient operation.

In the University of London, for example, several

regulations may exist for an educational program. They range from matters regarding the admission of students to awarding the qualification. For example, in the program for the Bachelor of Education (B.Ed) degree, there exist internal and external regulations. Within the internal regulations are old regulations, which amount to about 60 pages plus another 15 pages added, called general regulations. There is also an amendment booklet No 6 dated May, 1976. These regulations are made by the senate, which is a governing body within the University of London.

Regulations, when applied in this way tend to be regarded as everlasting rules which teachers and students "merely follow".

In a field of discipline, such as Cybernetics, Regulation connotes a mechanism for controlling either certain physiological and neurophysiological organs of the body, or a machine, a process or plant, or a teaching and learning situation where a required level of activity is sought. It is in this sense that Regulation, spelt with a capital "R" is used in the rest of this thesis.

Given a teaching and learning situation where a desired level of activity is sought and has to be maintained for a reasonable amount of time, if there is no Regulatory Mechanism then the level of activity will be subject to such a large variety of disturbances, that it may be impossible to maintain a teaching and learning situation. Regulation reduces the variety of the disturbances that are transmitted to the required activity level.

Thus, in the absence of a Regulatory Mechanism in a teaching and learning situation, where a desired level of activity is sought, it would be difficult to maintain that the form of knowledge and level of attainment desired without having a high failure rate.

If a teaching and learning situation is to be developed into a cybernetic system, which is the intention of this thesis then two types of Regulation must be developed.

The first is Regulation by error control, which has been used in an adaptive teaching system by Gordon Pask. Regulation by error control is used in a computer-based instruction package developed by IBM, and by some course designers in the form of computer terminal exercises developed for the Open University.

The second is Regulation by a normative and anticipatory system, which has been developed by the writer as part of a cybernetic approach to teaching and learning systems for a worthwhile Management Education. A model of this type of Regulation is examined in section 4:3.2.

4:3.1 REGULATION BY ERROR CONTROL

With Regulation by error control, the regulator draws its information from knowledge of result after matching the response against a target or goal response. Any error — the difference between a student's response to a problem or question and the correct answer — which is outside the acceptable limit, set by the teacher, is fed back to the

student in a short time interval, depending on the nature and complexity of the problem and technology used. The next step for the student, who interacts with such a teaching system, is to identify some cues or be given some clues by the teaching system which reduces the variety of possible subsequent responses and increases his likelihood of making a correct response.

In figure 4/01, exhibited below is a diagrammatic representation of an adaptive teaching machine, with error control features, which was developed by Gordon Pask.

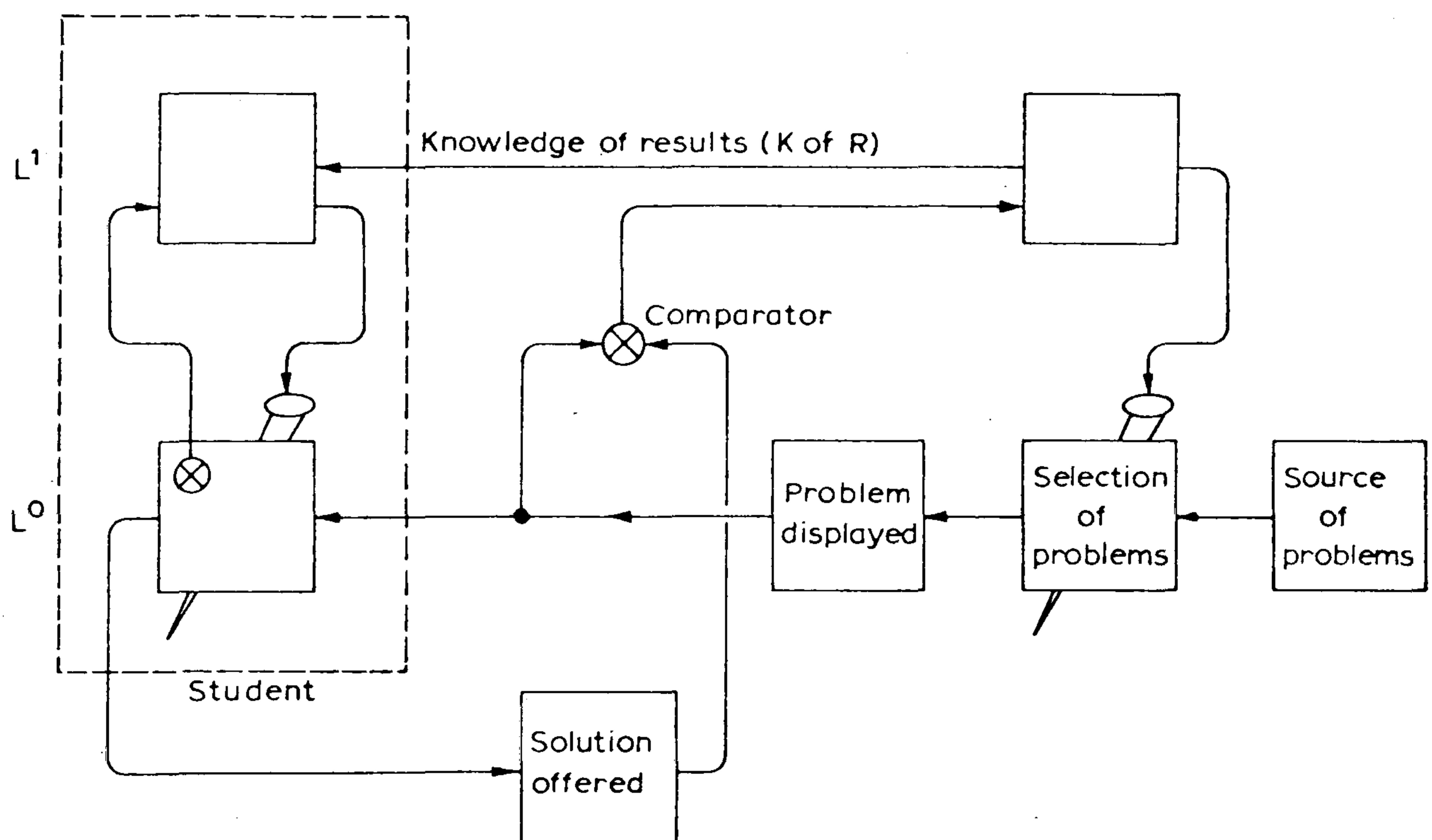

Fig.4/01 Simple adaptive teaching machine.

Regulation by error control is present in many Computer-Assisted Instruction (CAI) programs developed for the Open University, the University of Leeds and others. They select topics like statistics, modern mathematics, computer programming because of their highly structured nature which make implementation more straight forward.

But computer-based adaptive teaching systems have been developed by IBM research unit for teaching managers financial analysis so that they can ask "what if" questions, and maintain a desired level of activity. Some of these systems are available on a time-sharing basis.

4:3.2 REGULATION BY A NORMATIVE AND ANTICIPATORY SYSTEM

In developing this type of Regulation, the model builder or system designer should use the following criteria:

- (i) He must determine the level of required activity sought in a "module" or unit course in an educational scheme, and the representative region in the behaviour space which the system seeks to maintain in spite of disturbances for its efficient operation. The behaviour space in this context may be an acceptable limit, expressed as η of "S", such that η , being the range between 60 to 100 per cent of a unit course marks gained, and "S" denoting a satisfactory grade, which certify mastery of that unit course.

The model builder or systems designer must know:

- (ii) the important components of the forms of knowledge or/and skills which must be achieved to meet η of "S";
- (iii) the minimum entry requirements or capability requirements which the students must have in order to understand, interpret and process the instructions received, and
- (iv) what are the important disturbances that affect η of "S", and be able to identify them.

The model builder or system designer must:

(v) be able to make a prescription or prescriptions as to the set of corrective action to be taken to achieve and maintain η of "S".

(vi) The model must contain a minimum set of components to enable a prediction of the behaviour of the system to be made. The accuracy of the prediction may be done within certain degrees of confidence acceptable to the university or educational institution.

A regulatory mechanism with the above may be developed within the structure of a normative model. A normative model is a structure described by a model builder or system designer or observer, which he employs to prescribe, for example, the most effective ways of achieving a desired level of activity including the forms of knowledge or skills connected to the desired level of activity. Such a model is prescriptive, and provides a yardstick for evaluating what ought to be done in a real-world situation.

Regulation by a normative and anticipatory model differs from Regulation by error control in that the latter tells us what happens after the fact whereas with the former, anticipates the disturbances before they actually affect η of "S", and attempts to set forth the best means of achieving and maintaining a standard.

Here is a diagrammatic representation in figure 4/02 of a model of Regulation by a normative and anticipatory system, which may be used for a unit course.

Figure 4/02: A DESIGN FOR REGULATION BY A NORMATIVE AND ANTICIPATORY SYSTEM



4:3.3 EXPLANATION AND DESCRIPTION OF MODEL IN FIGURE 4/02

In applying the six criteria to the model developed in figure 4/02, it is necessary to produce the following explanation and description in order to unfold the model. It is also the intention of the researcher that the foregoing explanation and description will serve to testify the practicability of this model.

Under criterion: (i)

η is established by some concept or by a consensus, which is given as the range between 60 to 100 per cent of the unit course marks.

Under criterion: (ii)

The important components, or forms of knowledge or/and skills which must be achieved to meet η of "S" are usually contained in the unit course content. However, the variety in the unit course content could be very large and assessment based on one set of knowledge and skills within the unit course content can differ from another set developed by another teacher or assessor. What then is required, is a reduction in variety such that one key set of knowledge and skills (the forms of

knowledge) derived from the unit course content, is carefully established.

Take course unit 8:41, interface module developed in section 8 of this research, the key set of knowledge (forms of knowledge) and skills may be: (a) care in observation and analysis of relevant matters in the assignment; (b) diagnosis of the problem in the assignment and evidence of logical and plausible reasoning; (c) design of investigational methods and justification of the methodology used, and (d) performance in the presentation of his findings to a committee or at a seminar. These forms of knowledge may also be derived from the goal of the unit course in a hierarchical way.

Under criterion: (iii)

Students admitted on this type of educational program must have a minimum entry requirement (pre-requisites) to enable them to understand, interpret and process the instructions received in such a manner as to bring about learning. The students entry requirement for example to the masters program developed in section 8 should be: (1) a 1st or 2nd

class honours degree from a university or educational institution of the United Kingdom in either applied science, business studies, or appropriate forms of knowledge that will facilitate minimum understanding of the functions of a business or corporate enterprise;

(2) A post-graduate Diploma in Management Studies with corporate membership of the British Institute of Management;

(3) Professional qualification in such disciplines as accountancy, production engineering and specialist activities including Research and Development in industry with appropriate experience.

Under criterion: (iv)

It is necessary to know the important disturbances which are likely to affect η . The model builder or systems designer should set down the likely disturbances so that they can be identified by a teacher using the system.

Disturbances affecting a desired level of activity or standard of achievement of mastery may occur from the following:

1. Poor communication methods by the teacher or professor — inarticulate speech, poor transmission and inaudible reception;
2. Lack of sufficient theoretical or practical knowledge by the teacher in the domain of knowledge which is being communicated; or
3. Where a body of knowledge or learning task is presented to students in a difficult mode, and without any consideration for effective presentation.
4. Poor teaching and learning environment — physical, psychological, organisational and administrative surroundings;
5. Poor motivation by students — a factor of special significance when applied to adult students; or

6. Where there are no logical or purposeful structure and order of instructions which are designed to guide the learner efficiently to the level of attainment required for mastery.

7. Ineffective knowledge of results, i.e if given, it does not help the learner to modify his response.

8. Where a teacher has a different interpretation of the aims of a unit-course for which he is teaching. And, when he is not aware of the goals of the curriculum.

9. Where a teacher ignores his students' logic of reasoning. And,

10. When a teacher shows an indifferent attitude to a learning task or field of discipline, which is being taught.

Under criterion: (v)

The model builder or systems designer must be able to make a prescription as to a set of corrective action to be taken to reduce a set of disturbances, and achieve and maintain a high level of

mastery. In this research the ability to make and design prescriptions is based on research evidence supported by six years of teaching management and administrative studies, and three years of teaching Cybernetics to professional managers, teachers and educational technologists.

The simple switching device in the model represented in figure 4/02 has ten counters. Each counter represents a set of prescriptive actions designed to limit a particular disturbance, although it is conceivable that one type of disturbance may have some characteristic in common to another type, thus forming a logical product. Similarly, it may be found that one type of disturbance can be treated in some cases by two sets of prescriptive action.

The answer to any of these situations if they occur is to look at the dominant characteristics in each type of disturbance then apply the appropriate prescriptive set of action which is derived from a matching for equivalence or close equivalence. Commonsense and pragmatics should also be used in these situations.

The output from a set of action (a counter) to the disturbance is the effector, which then becomes a factor which acts on the group of students, being the operands, and result in a transform to meet the desired level of activity, η of "S".

Any deviation will be fed-back for re-definition and evaluation of the prescription. There is also the possibility of deviation caused through real difficulties — such as students being ill or absent for a substantial duration; administrative upheaval, and teachers' strike which can affect the effector side in the model. But these real difficulties would have a greater effect on the level for mastery in a teaching and learning situation which has no such Regulation than one which has that mechanism.

4:3.4 PRESCRIPTIVE SETS OF ACTION (AS COUNTERS) TO MEET SPECIFIED DISTURBANCES

The alphabetical symbols denote the sets of prescriptive actions which should be taken. The integer placed at the side of each alphabetic symbol denotes the corresponding type of disturbance to which the prescriptive action refers.

The membership of each set is not defined in a rigorous mathematical way such that each element must be well-defined numerically. Instead, a set is defined as a collection of actions which have some characteristics in common such as to meet a particular disturbance.

2

(A) / 1 The prescription for poor communication methods by the teacher or professor as stated in disturbance one is dealt with in section 5 of this thesis.

(B) / 2 A lack of sufficient theoretical or practical knowledge in the content of modern Management is widespread in Management Education. On one side there are many academics who have done some research on such topics as decision analysis, decision theories and organisation control without having adequate practical experience in Management, but somehow managed to rise through the academic echelons owing to promotion structure. In many universities the promotion structure is based on the length of service; the quantity of publications (however impracticable) and the number of committees which he or she is a member of.

On the other side, there are people with a great deal of practical experience in the topics outlined above, but earn more money in industry or in commerce than what they would get if they were teaching at a university or an educational institution.

An attempt to put right this dilemma would involve the following actions:

- (a) that academics be encouraged and given study leave to spend some time in industry or in a corporate enterprise. This should be supported by studies in Cybernetics;

- (b) that those managers or consultants who have practical experience in modern Management; organisational control, managerial problem-solving and decision making should be given a comparable salary with a senior faculty member. However, he or she should undergo further studies in the underlying principles of control and communication, and the practice of education. And,
- (c) the promotion structure should be amended to consider the qualities outlined in (b), plus a greater effort to stimulate more attention to pedagogy than at present.

③ / 3 The mode in which a body of knowledge or learning task is presented to the learner can either affect or improve the learner's ability to learn. This is very relevant to the adult learner who has developed a certain cognitive style before entry to a masters program. The cognitive style is based to a large extent on the student's background and his initial preference for receiving a set of instructions and information in a certain mode. But certain forms of knowledge or learning tasks require different kinds of presentation. Some symbolic, some numeric in a tabular form and some graphical: There are also different forms of audio presentation in addition to the visual modes mentioned above. Thus a teacher on a management educational program ought to improve his knowledge of audio/visual presentation in relation

to teaching a body of knowledge or learning task.

Here are some actions which a teacher should consider. Before selecting a form of audio/visual presentation a teacher must first know the goals of the course or learning task, the structure and sequence of knowledge which are to be taught, then identify and select the best form of audio/visual presentation which will achieve a required level of attainment.

The mode of presentation is also connected to the mechanism of communication developed in section 5.

However, the following is a brief summary of points for guidance to a teacher on a management educational program.

(a) The form of knowledge when presented in audio mode should not contain too many numeric or symbolic data. The narration or lecture should not be too long over one hour continuously. A lecture presentation and tutorial discussion are favourable modes for philosophical aspects of management studies and language oriented studies.

(b) Written textual presentation involves a knowledge of semantics, "the science of meaning", or the meaning of words, which is an important branch of linguistics and modern information theory. This mode is best suited to the form of knowledge conveying intention, descriptions and explanations.

(c) Tabular form of presentation are suitable for problem-solving situations which involve the abstraction of data and information, i.e a linear programming problem. It is also appropriate for providing two-way comparison i.e actual production of portable colour television against planned production of portable television.

(d) Symbolic and mathematical presentations are suitable for scientific measurement and the logic of reasoning.

(e) Diagrammatic presentation gives the students an insight into the problem or learning task, and an understanding of the relationships and parts to a whole. It is the nearest to having an actual model of the real system. This mode is suitable for teaching Cybernetics and systems design.

(f) A suitable combination of any of the suggested modes of presentation that will achieve a high rate of learning is worth aiming for. These modes of presentation may be supported by modern technological aids.

(D) / 4 Comfortable physical surroundings apply to the class-room as well as to business and corporate enterprises. A class-room which is designed to improve physical comfort — better seating, good light control that permits the use of projected materials, tape recorders and amplifying unit in a large class-room; sound control which encourages reverberations and permits speaking and listening in comfort — has a greater potential for efficient communication and increases comprehension than a class-room which is not so designed.

Psychological surroundings are difficult to isolate in a teaching and learning situation. But an indifferent attitude to a course or to the university or educational

institution can be formed, at least initially, if the physical, organisational and administrative surroundings are poor. Good physical, organisational and administrative surroundings will improve communication which may generate a stable interactive situation. This could bring about a sense of pride and improved morale for teachers and students.

ORGANISATIONAL AND ADMINISTRATIVE SURROUNDINGS

A masters' program which is designed to provide a worthwhile Management Education has to have a proper organisational network that is distinct from the administrative procedure of the university or educational institution offering the program. This type of organisational network would be designed to effect the curriculum goals of the scheme, it is called SYSTEM TWO. A model of SYSTEM TWO is developed in section [8] of this thesis.

This organisational network will provide contacts with the real world. These contacts will develop into serious arrangements for:

- (1) community study which exposes students to the various learning situations through which they will have to come into direct contact with.. This involves an insight into the operations of certain important government departments and institutions; studies in real world issues, and visits to various organisations see section

[8:31]

- 87
- (2) electives; and
 - (3) operations work.

Ⓔ / 5 Most post-graduate students of British Universities and educational institutions are free agents in that they become post-graduate students of their free will. They are not subject to the same compulsion as pupils who have to go to school. Post-graduate students enrol on a master's degree program because of:

- (a) certain inducements, i.e financial and good job prospects;
- (b) values, i.e social and esteem; and
- (c) motivation to do something worthwhile for their community or for humanity.

These are the reasons which will make an adult student willing to learn, but not all of them need be held by each student.

The set of actions to improve poor students' motivation would involve:

- (i) the program director having to provide information on the development and achievements by graduands (students who have successfully completed the program) in his community or some other or/and any of the motivational factors expressed above;
- (ii) the program director having to set aside time for reviewing each student's progress and give

88

encouragement when necessary.

ⓕ/6 There should be some logical or purposeful structure and order, in the chunks of knowledge which students will encounter in learning a particular task or a topic. For example, in teaching pricing policies to management students, do we start from price theory as used in economics or examine pricing policies from the stand point of pricing products or jobs, taking into account plant capacity, fixed and variable costs? Do we look at pricing policies as a part of the marketing strategy of a business?

Suppose that dynamic programming is to be taught to management students, do we start from an appreciation of Richard Bellman's principle of optimality, to his computational process, to dynamic formulation then followed by a theoretical exercise? Or do we start from an illustration of the kind of problems and application of dynamic programming, to dynamic formulation, to the multi-stage process and rules followed by example method of computation, and then an appreciation of Bellman's principle of optimality.

Problems of structure and ordering of instructions will face a teacher of a unit course such as the interface module, [8:41] because of the different forms of knowledge contained in the "module". When faced with the structure and sequence of instructions many teachers use a trial and error method of some kind, which is time-consuming and open to many varieties.

Most research papers on structure and ordering of instructions tend to concentrate on simple structured task or on motor skills for some routine operation or a specific study of cognitive development in infants. From these research papers, two have been selected as having relevance to unstructured and managerial tasks. These are:

(1) Bruner, Jerome S.(1964) in "the Course of Cognitive Growth" contends that the usual course of intellectual development moves from enactive representation, iconic representation, and then to symbolic representation. This claim has been reached after various studies on children from 0 to 3 years of age and 3 to 12 years.

By an enactive representation, he means "a mode of representing past events through appropriate motor response". An iconic representation "summarizes events by the selective organisation of percepts and images, by the spatial, temporal, and qualitative structures of the perceptual field and their transformed images". And, a symbolic representation involves a symbol system representing things by design features that include remoteness and arbitrariness".

Bruner did not confine his claim of "the course of cognitive growth" to children within these groups, but made inferences that a similar pattern of cognitive development exist for adults.

Pask, G. and Scott, B.E.(1972) in CASTE: A System for Exhibiting Learning Strategies and Regulating Uncertainties", used a hierarchy, which they represented as a head node with sub-structures which have an entailment with "closure" requirement. Some partial ordering may be applied under CASTE.

Pask, G. and Scott, B.E. notion of structure and ordering of instruction for learning a certain task is exhibited in figure 4/03 below.

40

G. PASK AND B. C. E. SCOTT

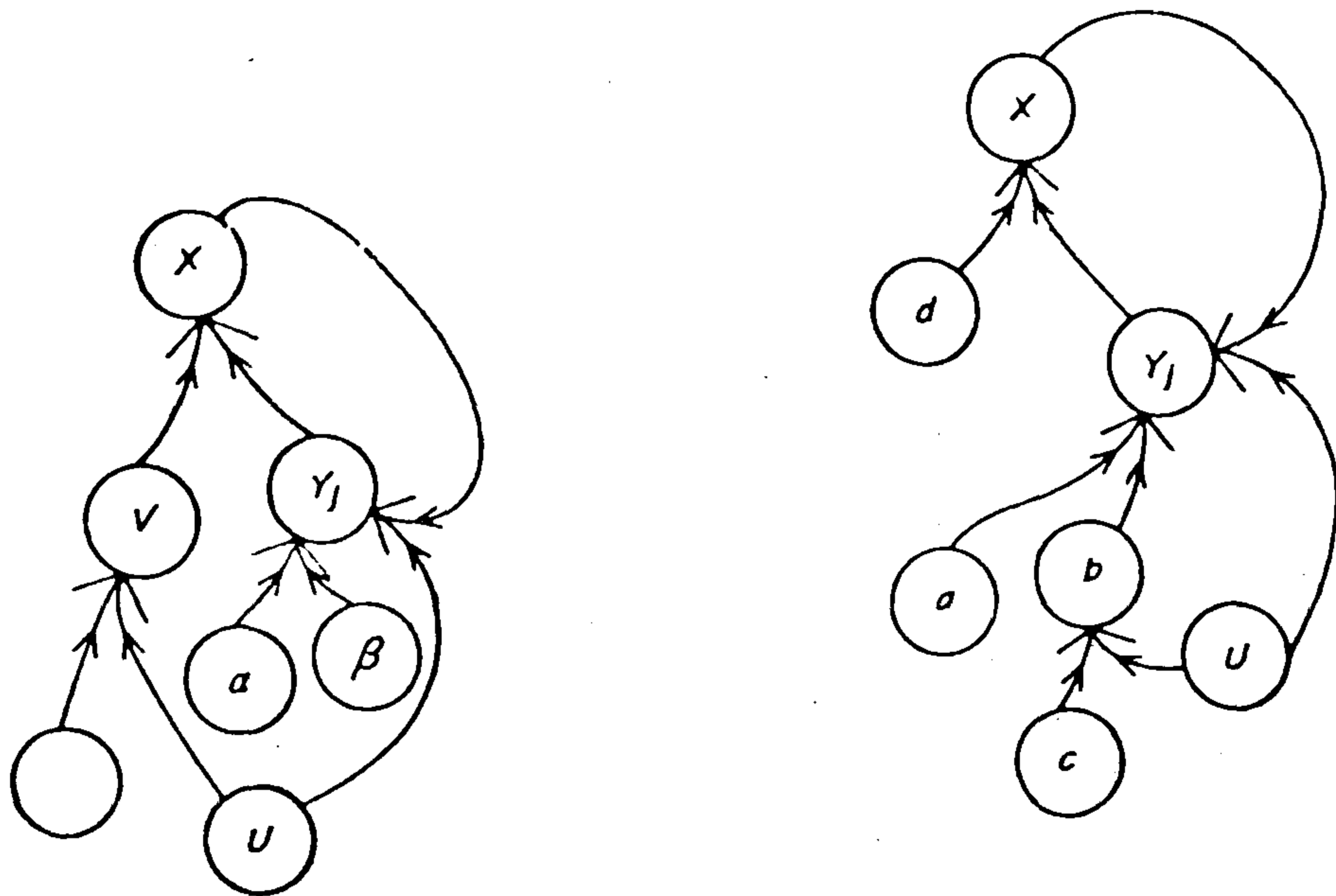

FIG.4/03 Closure condition of nodes labelled X, Y, in entailment mesh. Left: U is needed to build concept for Y given concept for X, hence U must be prerequisite for building some concept (for V, in this case) which is required to build concept for X, given concept for Y. But concept for Y may be obtained, also, from concepts for a and β. Right: Alternative closure requirement.

4:3.5 DEDUCTION AND PRIORITY TO GOAL RULE FOR DEVELOPING A STRUCTURE AND ORDER OF TEACHING COMPLEX TASKS

A teacher, when faced with the problem of having to develop a structure and order of instructions, which would lead a learner through an efficient path to mastery of a unit course, such as the interface model or a complex performance task, may use the deduction and priority to goal rule, developed by the researcher of this thesis below.

With this concept the logic of deduction is used starting from the curriculum goal. A hierarchy is then derived from a number of sub-goals which should be specific forms of knowledge and skills such as:

- (a) care in observation and analysis of relevant matters in the assignment;
- (b) diagnosis of the problem in the assignment and evidence of logical and plausible reasoning;
- (c) design courses of action; and
- (d) ability in the organisation and presentation of his findings to a committee or at a seminar.

The next level may be further sub-divided into smaller chunks derived from each sub-goal. The size of chunks should allow the student to grasp what is being taught, but large enough to require some effort to leap from one chunk to another.

The order of instructions should be based firstly on the level of hierarchy, but at each level of hierarchy, the

ordering should be based on the priority of importance ranging from the most important to the least important chunks in achieving the curriculum goal.

The levels of hierarchy will depend on the domain of knowledge, the time duration of the unit course and entry requirements or capability requirements of the students on the course.

Figure 4/04 is an illustration of this concept.

The first level

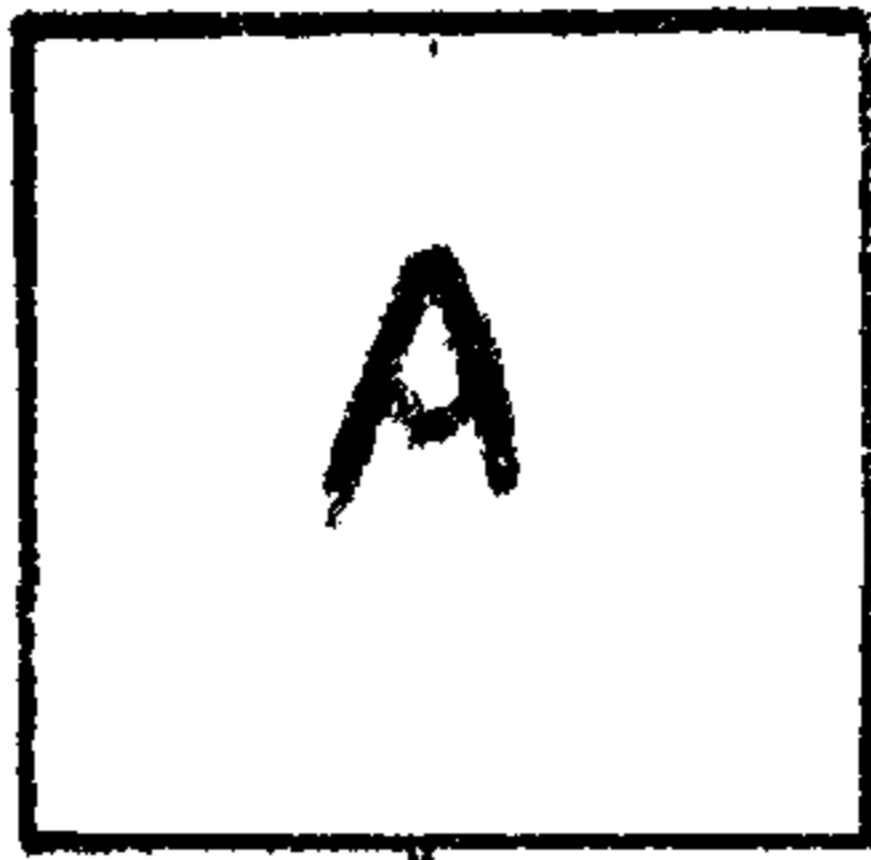

GOAL

Level two

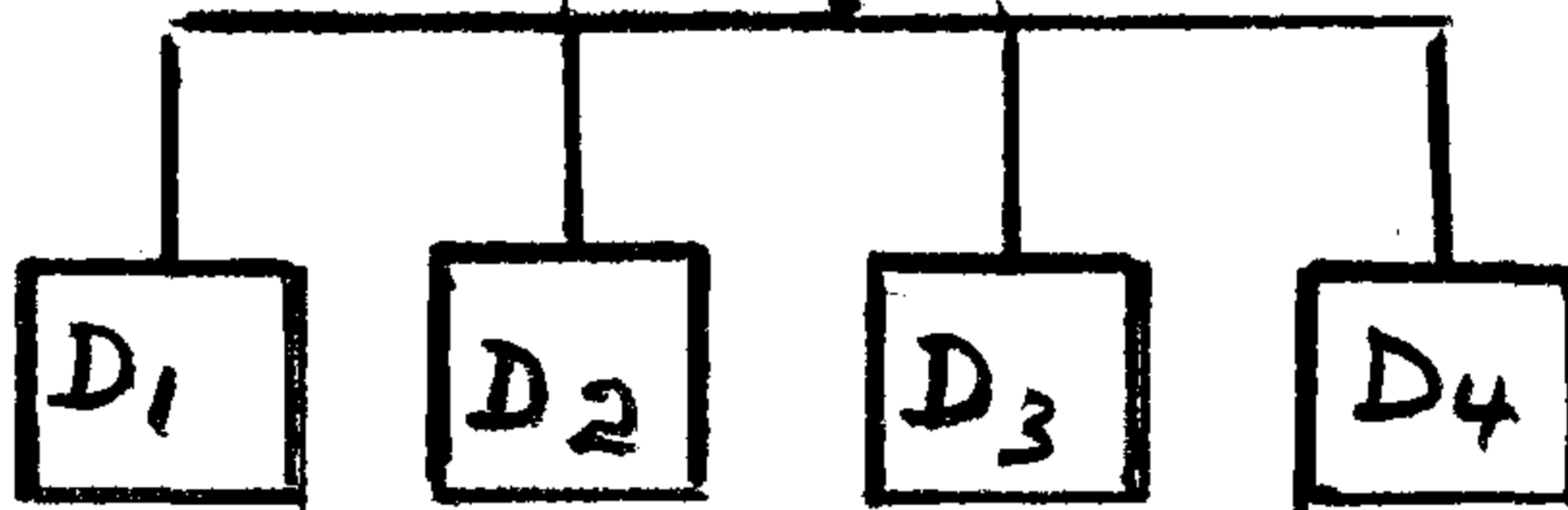
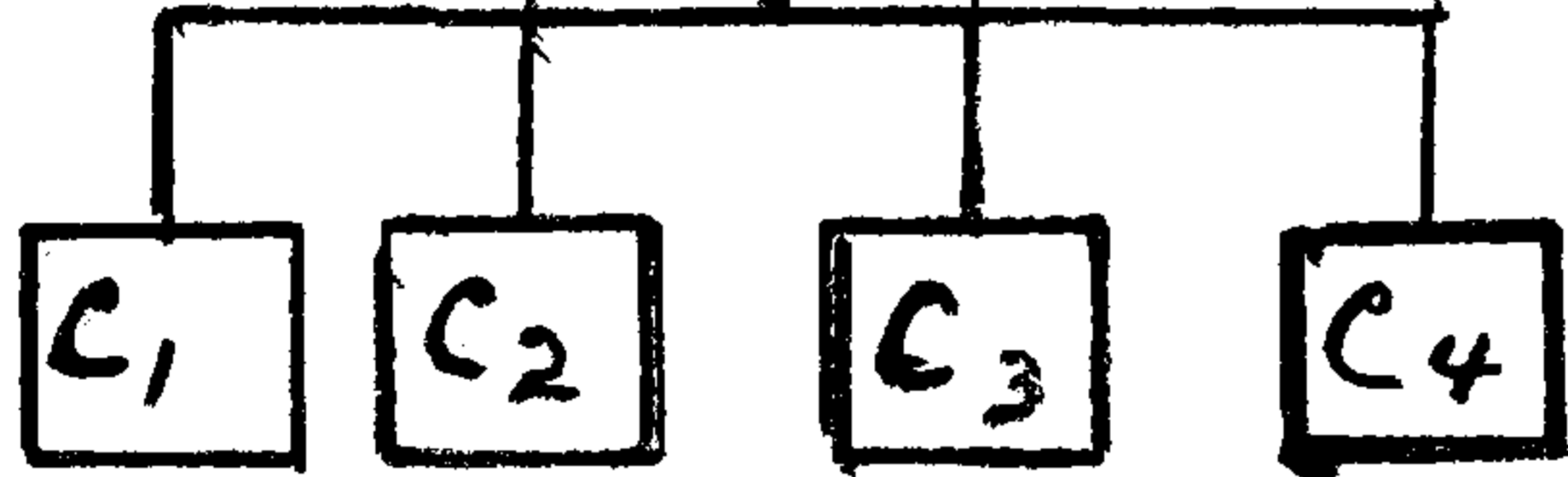
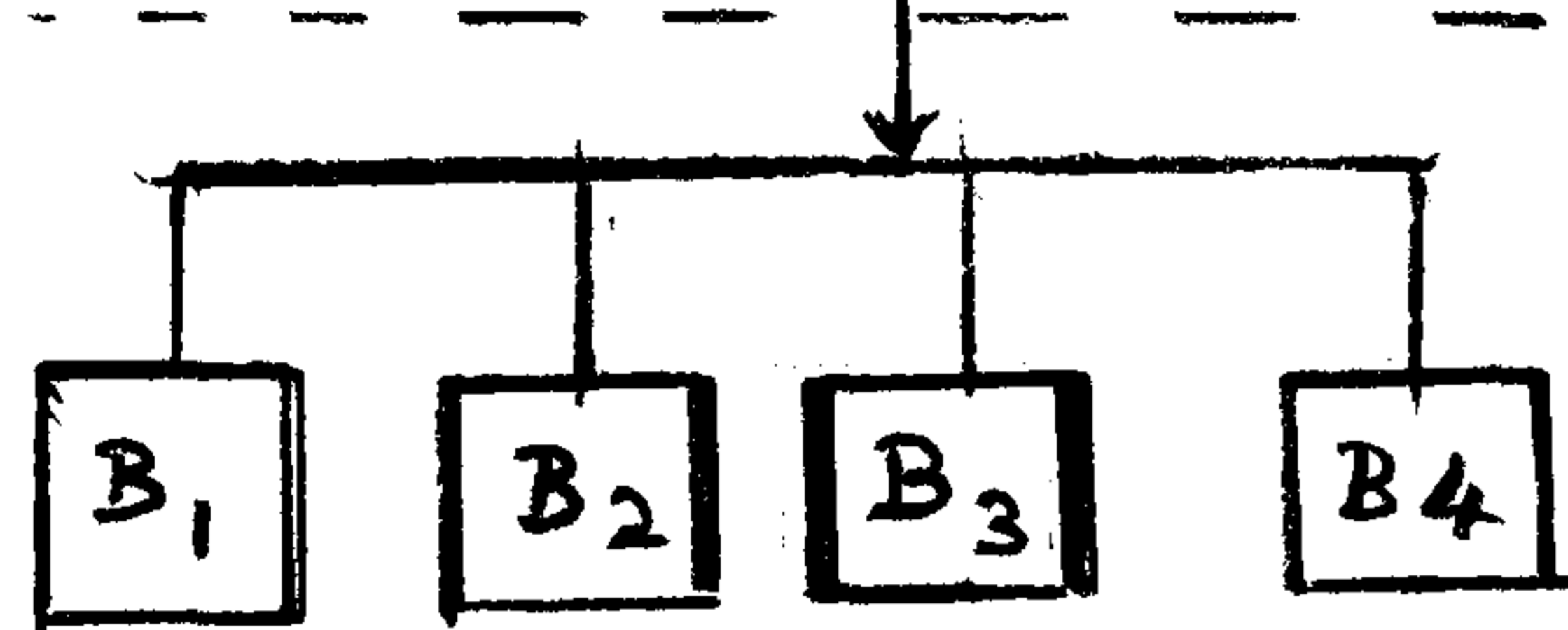
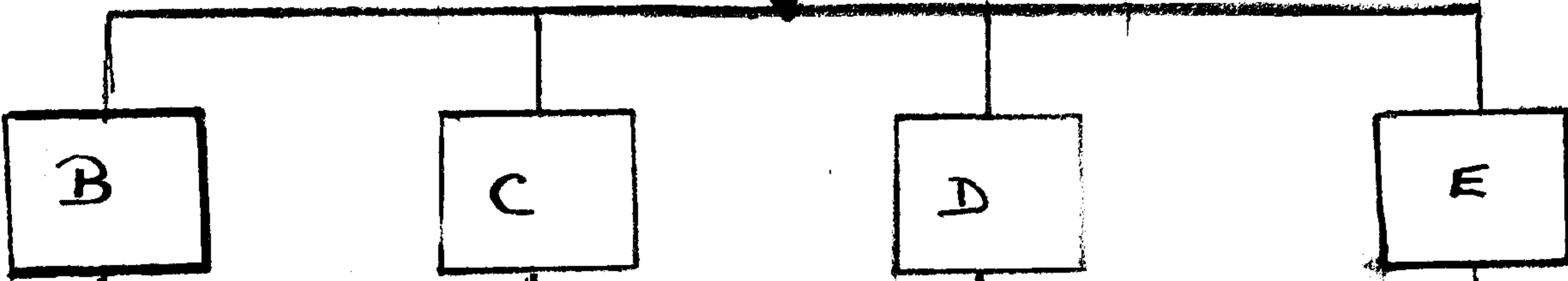

Level three

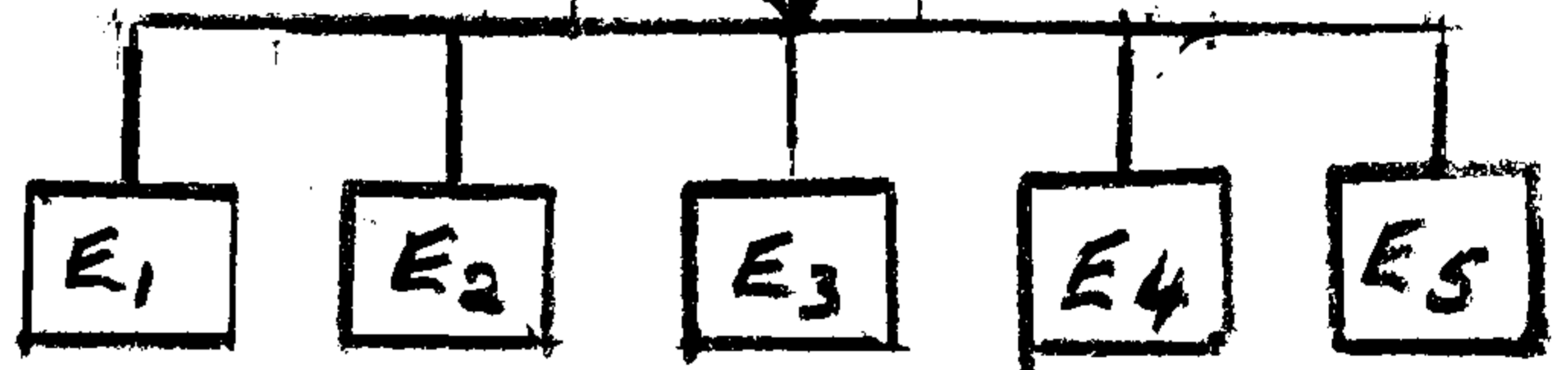

Figure 4/04, A STRUCTURE OF ORDERING

USING THE DEDUCTION AND PRIORITY TO GOAL RULE

The first level of hierarchy is the goal, A.
 The goal of unit-course 8:41 in section [8]
 of this thesis is, to achieve a certain competence
 in investigating managerial problems and
 diagnosing corrective actions to real-world
 managerial problems assigned to each student or a
 group of students.

Level two is arrived at by sub-dividing the goal, A into key
 constituents according to priority to the goal.
 Four constituents have been derived. They are:
 B, care in observation and analysis of relevant
 matters in the assignment given;
 C, diagnosis of the problems in the assignment
 and evidence of logical and plausible reasoning;
 D, design courses of action; and
 E, ability in the organisation and presentation
 of his findings to a committee or at a seminar.

Level three is derived from a sub-division of each key
 constituent into further sub-key constituents
 according to priority to each key constituent,
 such that:

- B₁, B₂, B₃, and B₄, are derived from B;
- C₁, C₂, C₃, and C₄, are derived from C;
- D₁, D₂, D₃, and D₄, are derived from D;
- E₁, E₂, E₃, and E₄, are derived from E.

9.

Each sub-key constituent should be outlined in order that the content of knowledge may be evaluated. Accordingly, the sub-key constituents are outlined below:

- B₁, Make observation in the quantitative and qualitative matters within the assignment;
- B₂, Make analysis of the observation taking into account the extent of knowledge about the general situation within that industry or type of problem;
- B₃, Discard irrelevant quantitative and qualitative matters;
- B₄, Marshal relevant quantitative and qualitative facts;

- C₁, Recognize or identify problems in the assignment;
- C₂, Define the problems, quantitatively or/and qualitatively;
- C₃, Produce evidence based on logical reasoning of the facts;
- C₄, Produce a reasoned argument which is plausible and based on beliefs and induction;

- D₁, Design courses of action that might be done;
- D₂, Decide and plan best course of action in the circumstances;
- D₃, Draw-up implementation schedule based on priority to sub-constituent;
- D₄, Show the possible consequences of the plan of action;

- E₁, Organise, document and write report of investigation of managerial problems or an assignment given;
- E₂, Prepare abstract of key issues of investigation;
- E₃, Prepare visual presentation in support of key issues of investigations;
- E₄, Reply intelligently to questions and accept suggestions politely, and
- E₅, Make note of feed-back, it is an essential condition for learning.

ⓐ

Knowledge of results is intimately connected with the process of learning, and is required whether a teaching system is active or not. In this section, knowledge of results is considered within a teaching system whereas in section [7] knowledge of results is considered from the point of view of the learner and a study of a process of learning.

An important function of any teaching system is bring about (the process of) learning by students, the intention of which is to achieve a certain goal or level of attainment in a domain of knowledge, say " X ". To have learnt a certain " X " would mean that a student has come up to some standard or achieved some mastery which he or she did not have on entry to the teaching system. Thus, for a curriculum goal to be achieved with a high degree of confidence in a teaching system, the learner must have knowledge of results at an appropriate time and in an appropriate form within the process of mastery.

If knowledge of results is given only after a student's response to the curriculum goal which may be contained in the form of an annual or final year three-hours written examination paper, then the knowledge of results, if negative, can be too late for guiding a post-graduate student to success without harmful psychological consequences.

A teaching system with Regulation by a normative and anticipatory mechanism should be so designed that the knowledge of results must be given either at each point of operation or chunk, or each sub-goal and each level of

hierarchy or each sub-structure or cognitive development, depending on the concept of structure or order applied. In this system, students get a series of positive results if their responses are leading them to mastery of the curriculum goal. A negative result is given at each juncture followed by information for corrective behaviour, which ought to be conveyed to the student before he proceeds to another juncture.

The form of knowledge of results should provide the kind of information which would tell the learner whether his behaviour is in fact leading him through each point or juncture or hierarchy to mastery. This design will require intermittent assessment as opposed to a final three hours paper towards the end of the program.

(H) / 8 A teacher may be given a copy of a curriculum content and a statement on the curriculum aim. But, he or she may place a different interpretation on the curriculum aim and different emphasis on the curriculum content.

Suppose that linear programming and decision-making were contained in a curriculum content of a unit course intended to provide an appreciation of the principles and application of operational research for managers. In teaching such a course, do we place emphasis on students having to do all the iterations and computations manually to a sizeable linear programming problem?

Do we regard the manipulation of sets of manufactured probabilities and expected values as the best criteria for good decision-making?

Do we believe that improved notations and advanced mathematical computation are most important for operational research than efforts to give managers a general understanding, and grasp of the basic principles of linear programming and decision-making supported by practical applications?

An efficient course designer and program director would have clear answers to these questions, but it is important for a teacher, who may not be the course designer, to get the right interpretation of the curriculum aim, and the right goals for assessment. If not, the curriculum as well as the goals of the educational program will be undermined, and variety in form and level of attainment will increase.

To accomplish this requirement, a program director should try to ensure that the teacher with the appropriate qualities and experience in practical applications of OR principles is selected to teach the course.

A program director will also have to cultivate a regular and harmonious relationship between the teacher and himself to ensure that the right interpretation of the curriculum's intention is achieved. The interaction from this situation leads to stability within the teaching system.

①/9 It is a common error for teachers in Management Education to ignore his students' logic of reasoning and assume that his method of reasoning is the best one. For a teacher may develop a good logic tree or algorithm on how to solve a certain type of problem, but although the logic used by the teacher makes good reasoning, yet some students may use different types of reasoning for solving the same type of problem.

Some students may use a conjunctive form of reasoning instead of a disjunctive form. Whatever form of logic they use, each student has a different facility for learning which is dependent on his previous knowledge and his understanding of the task.

Within a group of management students the pace of learning for each student differs. Thus in some instances there may be some students who are slow learners in one form of knowledge or topic while being exceptionally alert and quick learners in another form of knowledge or topic. However, in a given learning task where slow learners are identified a teacher may have to recommend further readings, or provide soft-ware packages (program learning packages) or be prepared to modify a chunk of instruction, at some stage of his lesson to smaller chunks. This action will enable learning leaps to be made in shorter steps for those slow learners than for the average chunks for the average students, and put them back into the mainstream of instructions after some extra work.

In other instances, there may be an exceptionally alert and quick learner in which case his pace has to be encourages rather than discouraged.

①/10 Suppose that a lecturer has to teach Cybernetics to a group of management students on a masters program or to professional teachers, because there is a demand by these students to include Cybernetics in their educational program. If the lecturer were to treat Cybernetics as a set of abstract and theoretical ideas which can never work in a real-world situation, which is likely to result into the group of students losing interest in Cybernetics then this constitutes an indifferent attitude to Cybernetics..

The lecturer, in order to inculcate a positive attitude of mind towards Cybernetics has to show a clear cut demonstration of a worthwhile application of ideas to this group of students. He may have to associate the mechanisms of control and communication with some worthwhile activity of public acceptance. Otherwise, the interest of those students who have never studied Cybernetics and are sceptical about its utility will not be improved.

Thus, a positive attitude for Cybernetics may be built-up when the field of discipline is taught in relation to something which a student can identify as worthwhile. Preferably, in a real-world situation, rather than when it is taught as a set of abstract and theoretical ideas which can never work in a real-world situation.

Under criterion: (vi)

The model has a minimum set of components to enable a prediction of the behaviour of the system.

These components are:

- (1) a memory with recall facilities;
- (2) computational facilities;
- (3) a selector device;
- (4) a receptor, and
- (5) an effector

1. The memory contains written instructions in the form of a prescriptive program. It also contains the teacher's memory which will regard events of the past as playing a part of the system's behaviour.

2. The computational facilities consist of conditional statements and logic of thought, matching the appropriate counter actions and prescriptive notions with the corresponding type of disturbances. These facilities are supported by the teacher's computational ability in applying the prescription using either probability of success of the number of students entering the system or

applying a certain degree of confidence to a particular prescription — using previous records.

3. A selector is the switching network which select a set of action or sets of actions.

4. The receptor is analogous to the set of activities concerned with sensing, interpreting and registering information about the disturbances which affect the level of required activity.

5. The effector represents the regulated behaviour in the teaching system which acts on the students to produce and maintain the required level of activity or standard of achievement.

5. EMPLOYING THE MECHANISMS OF COMMUNICATION AND ITS TECHNOLOGY FOR DESIGNING TEACHING SYSTEMS

Communication being an important part of Cybernetics, is directly relevant to the teaching/learning situations described in section 4, and has a means to an end relationship, between a teacher and students in the transmission of knowledge.

In cybernetic studies, communication may be viewed from two main areas of application, internal and external.

INTERNAL COMMUNICATION

Internal communication can be sub-divided into three classes namely:

- (i) The genetic communication;
- (ii) Metabolic communication, and
- (iii) Communication of the nervous system.

(i) The genetic communication relates to the precise sequence of the four kinds of nucleotide base — adenine, guanine, thymine and cytosine — in the D.N.A (DEOXYRIBONCLEIC ACID) molecules of the nuclei of its cellular constituency, and about genetic codes.

(ii) Metabolic communication is embodied in the quality and concentration of large and small molecules that participate in the chemical process by which cells reproduce, develop and maintain their living state. The mechanism of communication consists of the release by a secretory cell of

one of its constituent molecules. The released molecule diffuses through the space occupied by the cell society, and on encountering a target cell it intervenes in some highly specific manner in the metabolism of that cell. Such messenger molecules of metabolic information are generally called hormones.

(iii) Communication of the nervous system is a necessary function of the brain and physiological properties of the body. The nervous system may be divided into three parts:

- (a) an input, or sensory which informs the person about the condition with respect to the state of his external and internal environment;
- (b) an output, or effector which produces motion by commanding muscle contraction, and
- (c) an internuncial of nerves which connects the sensory and the effector. A great part of the internuncial of nerves is concentrated in the brain.

Activities of the nervous system are the concern of physiologists, neuro-physiologists and cyberneticians like Dr. Gray Walter and Professor F.H. George. The physiologist sees the brain as a complex mechanism and associates it with the chemical reaction of the body axons neurons coming in contact with neurons to form an inter-connected network over the entire body, and about reflex type (inborn) behaviour.

A cybernetician, such as Ashby, W.R.(1960) sees the brain as having a relation to learning and adaptive behaviour which are intended to take place at the recipient's end of the communication channel (of external communication).

EXTERNAL COMMUNICATION

External communication involves the procedures and mechanism which the animal, or human beings and some machines employed to transmit, instruct and impart messages and/or, instructions to another or others. This definition may encompass communication between machines including "the procedures by means of which one mechanism (say an automatic equipment which tracks an aeroplane and to its probable future positions) affects another (say a guided missile chasing the plane)" Shannon, C.E. and Weaver, W. (1948).

External communication is as old as man's evolutionary development, but what is different about the mechanisms of communication is that they contain scientific ideas and technology which the evolutionary approach did not have.

Three well known cyberneticians were at the fore-front of generating scientific ideas and technology to external communication. They were Wiener, N; Shannon, C.E. and Weaver, W.

Wiener, N.(1948) had propounded, among other things, that communication devices such as a telephone line or a television circuit, or an automatic sound coding device like a vocoder are capable of statistical measurement.

Shannon, C.E.(1949) having studied the ideas and philosophy of Wiener, developed, "The Mathematical Theory of

Communication" which became an essential work for analytical communication studies, by leading universities or educational institutions which have a faculty of cybernetics or communication science.

5:1 THE MECHANISMS OF COMMUNICATION

Shannon, C.E.(1949) in "The Mathematical Theory of Communication" reduced the communication process into a simple schematic diagram exhibited below in figure 5/01.

Shannon, C.E.(1949) used:

- (1) telegraphic channels which involve the process of encoding and decoding speech into a finite set of discrete symbols; and
- (2) television channels which involve the process of encoding and decoding one continuous or many continuous functions of signals as functions of time, and of two-space co-ordinates for transmitting continuous messages to demonstrate his theory. Among other things, he was concerned with the accuracy of the transmission of the sets of messages from the sender to the recipient (destination) which led to the present development in communication's technology.

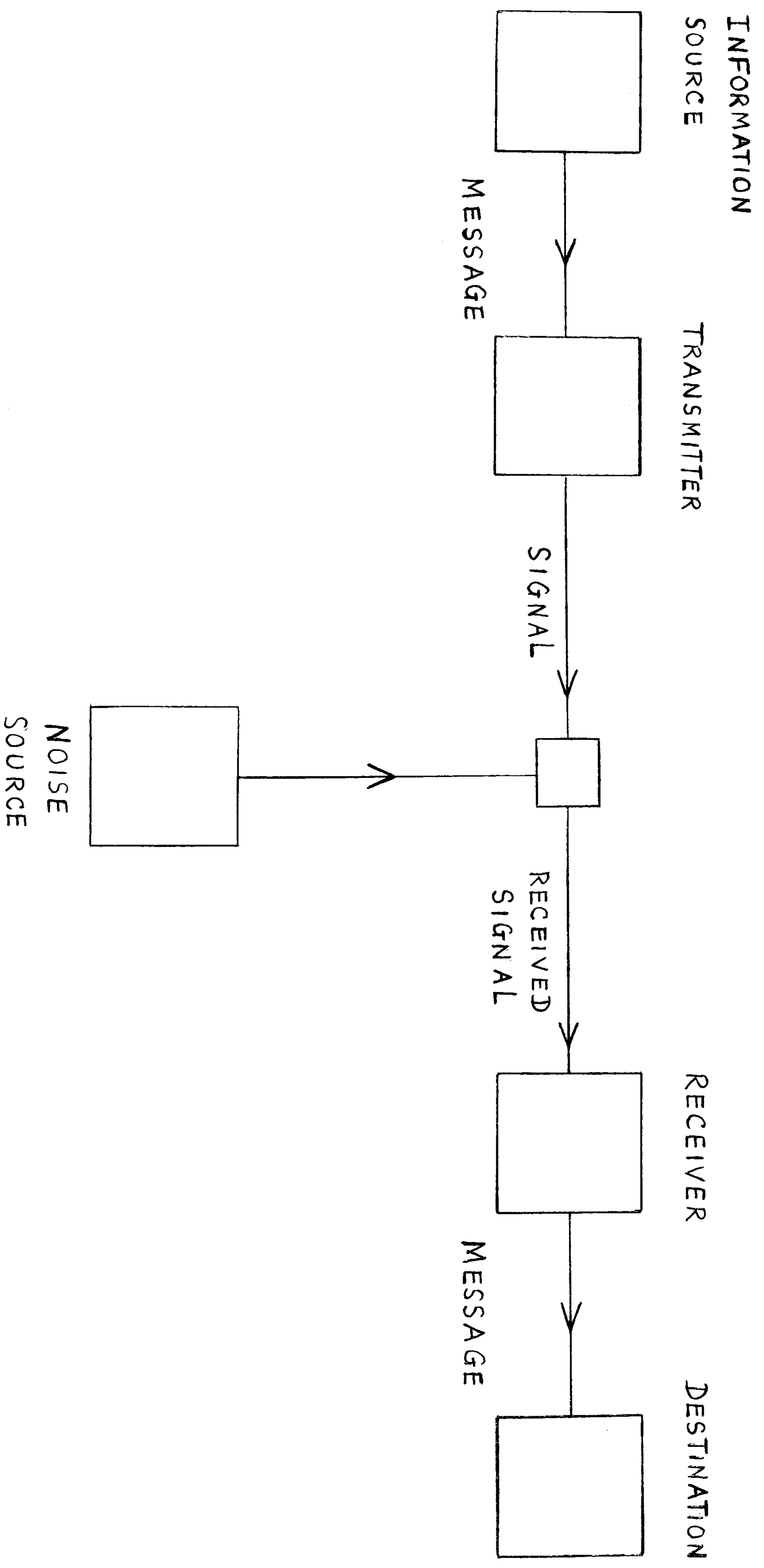

Figure 5/02: Schematic diagram of a general communication system.

A brief description of this diagram follows:

- (i) An information source. This source comes from the sender who produces the message or sequence of the message to be communicated to the recipient (destination).
- (ii) A transmitter. A device which operates on the message and change the form to an appropriate machine signal for transmission over the communication channel from the transmitter to the receiver. This involves an encoding operation which produces the appropriate signals.
- (iii) The channel. This is the medium used to transmit the signal from the transmitter to the receiver, which may range from telephone wires to the proposed "light pipes", under development by International Telephone and Telegraph Corporation. The proposed "light pipes" channel is capable of carrying enormous volume of signals, and operates at the frequency of visible light or infrared radiation. Thus, facilitating millions of voice signals or thousands of television signals to be conveyed per second. Report on the development of "light pipes" channel was given by Henri Busignies in signals, Vol 26 No3 November, 1971.

- (iv) **NOISE.** This occurs when the signal is distorted by errors either from the transmitter or receiver or certain extraneous distortions entering the channel from source other than between the sender and the recipient (destination). These distortions tend to affect the accuracy of the message and produce uncertainty.
- (v) **A receiver.** This is a device which operates on the signals received and performs a decoding operation by re-constructing the message from the signals ^{into} the natural written language or intended coded message which is selected by the sender for transmission to the recipient (destination).
- (vi) **The recipient or destination** is the person or machine in some cases, a computer terminal, for whom the message is intended.

Many aspects of "The Mathematical Theory of Communication" as propounded by Shannon (1948) have important significance for teaching and learning.

Warren, Weaver.(1948) extended "The Mathematical Theory of Communication" to include the semantic and pragmatic aspects of communication. He did this by examining such questions as: (i) How precisely do the transmitter symbols convey the desired meaning? and

(ii) How effectively does the received meaning affect the conduct of the recipient (destination) in a desired behaviour.

5:2 THE TEACHER AND THE ACCURACY OF MEANING
IN THE TRANSMISSION OF KNOWLEDGE

A teacher in the process of transmitting items of knowledge and learning instructions should be concerned with the accuracy of the meaning conveyed to his students. In teaching a field of disciplines like management accountancy or mercantile law, the meaning of the items of knowledge transmitted to the students is influenced greatly by the operational use of the message or the context in which the message is used.

In teaching interdisciplinary fields of discipline like operational research and Cybernetics the meaning of a set of messages must be precise because each field of discipline may cultivate its own terminology. Where the interaction of ideas is to be communicated across disciplinary boundaries some

precision as to the meaning of a message or set of ideas are necessary for participants of other disciplines to communicate in problem-solving matters. This is achieved by agreement after continuous intercommunication among the participants from the different disciplines on terminology, concepts methodology, procedures and sometimes epistemology.

In providing Management Education for real life situations, the teacher must consider how accurately he can convey the work and problems of Management in a realistic setting.

It is worthwhile for a teacher to know that certain channels of communication are inappropriate for transmitting certain types of knowledge. If he knows that a lecture without visual presentation has a limited channel capacity for conveying accurately the kind of affective situation which can occur in a manufacturing or assembly plant as a result of poor production scheduling then he would use a communication channel with a greater capacity.

The second important factor which may affect the accuracy of the transmission of knowledge is the proportion of noise which may arise in the transmission. If the channel is that of speech then there is a speech to noise ratio; if it is by signal as in the machine sense then there is a signal to noise ratio. The contention is that if a high proportion of noise occurs on a channel there is a related probability that the recipient (destination) may not receive the message accurately. Thus great effort should be used to minimise noise in any channel of communication selected to transmit knowledge.

5:3 IMPROVING ACCURACY IN THE TRANSMISSION OF KNOWLEDGE

The important reason for seeking to improve accuracy in the communication of knowledge in an educational system is to give students a clear understanding of the intended knowledge which the teacher is trying to convey.

Understanding, according to Allport, G.W.(1937) involves "apprehending the meaning or significance of what is known". In this thesis understanding is used in the following way, if a student, denoted by the symbol s responds to an instruction sent by a teacher, denoted by the symbol "t", such that s produces a description or action which is in agreement with a concept or universe of discourse of the instruction then s is said to understand "t".

A common language and a common interest are ways towards understanding the meaning of instructions intended to bring about learning. With regard to a common language, it is usual to expect students to understand the grammar and syntactic framework of the language which the teacher is using. But it is not the rule that grammatical preciseness is the best way for understanding instructions. It is possible to generate a number of instructions and statements with grammatical preciseness, but containing a great degree of ambiguity. For according to Chomsky, N.(1957), "Grammar is best formulated as a self-contained study independent of semantics. In particular, the notion of grammaticalness cannot be identified with meaningfulness (nor does it have any special relation, even approximate, to the notion of statistical order of

approximation)".

A student who has a common interest in a domain of knowledge may check a source of reference for the morphemes or words composing an instruction and try to ascertain the meaning which he will match with the teacher's concept.

A way of improving accuracy in conveying knowledge is to devise proper instructional procedures such as those developed in section 4:3.4, to achieve the intended level of activity.

Another way to improve the accuracy of the instructions is to repeat the instructions several times, but it is not always possible to get a teacher to repeat a lecture several times. However, where technological devices, such as tape or cassette recorders and video-tape recorders, can be used to record and repeat a lecture then teachers should be taught how to use them for this purpose.

A further way to improve the accuracy in the transmission of knowledge is to eliminate or reduce the proportion of noise to the point that it does not affect the accuracy of transmission. Clear and articulate speaking and attentive listening can improve the accuracy of the instructions.

5.4 CAPACITY OF THE COMMUNICATION CHANNEL

When a teacher wishes to convey the work and problems of Management in a real-world setting to students then he should consider a communication channel with sufficient capacity for speech, sounds, imagery, displays and perhaps movement. The technology which can make use of all the different modes of presentation to achieve a high level of understanding in real-life situations is television. Television has a channel capacity for transmitting between 60 to 90 million bits per second.

With the present status of technology in communication, the lecture to students relationship as a way of conveying real-life situations is inappropriate, particularly in cases where a business or corporate entity has to be examined in its entirety; or where the problems in managing are to be examined in a real-life setting.

An appropriate way to convey the problems of Management in a real-life setting is to build canned-case teaching programs supported by educational television. This will require more preparations and team work.

5.5 BUILDING A CANNED CASE-TEACHING PROGRAM SUPPORTED BY EDUCATIONAL TELEVISION

Suppose professor "L" has to teach value analysis and wanted to convey to his students the problems concerned when applying this approach to a medium-sized (not less than £3

millions and not more than 60 millions pounds sterling market capitalization) business enterprise producing several electrical (domestic) appliances. A case containing problems of applying analysis should be selected from either SYSTEM TWO or from an actual situation in the business-world with the use of pseudonym to avoid identification of that enterprise. A particular product or set of products should be selected, say a set of radiograms.

The case should be analysed thoroughly by faculty members and specialists outside the university or educational institution. The faculty members, outside specialists and others should cultivate a real-world setting and introduce role-play where it is required. Professor "L" will then prepare a series of lectures on the concept and techniques of value analysis and may do a narration between the role-play intervals and case exercises which will be prepared by professor "L".

The production of the program will go through a series of pre-recordings before presentation to the students, and a competent producer appointed. The case should be pre-recorded for the following reasons:

1. If mistakes, such as the caption appearing upside-down, the displays become mismatched with the explanations or where professor "L" exceeds or under-estimated his time then these mistakes can be put right before the program is transmitted. These rehearsals should be recorded on video-tape, after which the necessary corrections can be made; and

2. There is also a visual style for the case-program which has to be built around the case study. Here the producer will work in conjunction with professor "L" who is giving the series of lectures, and the role-playing team (to producing) a real-life setting. Professor "L" should be placed in an armchair against a plain background or views similar to that in a board of director's office, and letting him be seen occasionally between film sequences, and when he is examining certain key figures and making decisions with his colleagues. Another style may be adopted when he is lecturing about value analysis. Here he may be seen to be mobile: appearing on the shop-floor analysing the assembly of radiograms; looking at method study; visiting the product design office and talking with product designers, against a backing of a large diagram showing the elements of the radiogram, and in an office reflecting the status of a high level manager trying to eliminate unnecessary cost.

The producer may give professor "L" feed-back by suggesting whether professor "L" ought to spend more time on a demonstration or explain a particular situation more carefully. Once these scenes are recorded they can be put into cans and brought out when necessary.

The canned case-teaching program should be built so that it can be used in modular blocks to facilitate one-week full-time study with exercises or three weeks part-time or sandwich study supported by exercises structured and sequenced for this duration.

At the end of the case-study students should be shown

how the managers have dealt with the case, and a short discussion by a panel of experts.

After the presentation of the program, a group of students who have worked through the case-study and participated fully in the study may be asked to discuss the case, their findings and give explanations, which can then be produced and recorded on video-tape then added to the canned case-teaching program so that the subsequent set of students could see what their colleagues have done previously.

A distinct advantage of having such a program is that it can be stored and reproduced many times, thus extending its coverage to a larger audience than in the lecture to students communication channel. For the canned case-teaching program can be loaned or put on hire to other universities, educational institutions, and for in-service training.

The presentation should be well thought out. The case-study, case exercises, notes and suggestions for reading should be clearly printed and distributed at the commencement of the canned case-teaching program.

6. THE PROCESS OF HUMAN LEARNING, A BLACKBOX APPROACH

Human learning is a continuous process, but when a teacher is involved in trying to bring about learning of a particular task or topic by students, he may look at learning as a goal oriented activity. In school, learning is concerned with mastery of a certain subject or topic or a certain "X". To have learnt a certain "X" would mean that students have come up to some standard or have achieved some mastery which they did not had on entry to a course and/or an educational scheme.

To examine the process of learning in the context of education would require as a minimum, a study of:

- i) how should students learn what we want them to learn? and,
- ii) how do they actually learn what we want them to learn?

Two approaches to these questions are developed in this thesis. The first is a "blackbox approach" and the second, is a concept of information processing and the phases of human learning and problem solving.

This "blackbox approach" examines the process of learning from the input/output relations of the learner and proposes that there are five essential phases in designing a protocol on how management students should learn what we want them to learn. The term "blackbox" means an encased mechanism within a system whose internal structure is not usually opened for inspection while the system is in operation.

In the case of an aeroplane, the "blackbox" is opened after the system ceases its operation or after the system dies.

A "blackbox" does not necessarily mean that the investigator knows nothing about the "blackbox". For example, a "blackbox" in an aeroplane records data on the functioning of that aeroplane and its systems on tape or wire. The functioning and recordings are encased in a crashproof, and floatable box which is ejected in case of an accident.

In the case of human learning, the "blackbox" may be regarded as the encased mechanism of the cerebrum and the nervous system. Not all investigators know how or wish to speculate with categorical evidence about the mechanistic workings of the "blackbox" in relation to human learning. Although Cyberneticians like Ashby, W.R (1960) in "Design for a Brain"; George, F.H (1961) Behaviour and the Nervous System in "The Brain as a Computer" and Walter, W.G (1952) in "The Living Brain", have postulated the existence of a direct relation between a) The cerebrum and the nervous system and b) learned behaviour of human-beings.

However, this "blackbox approach" omits to show or speculate on the internal physiological mechanism and its functioning in relation to learning, except, that it assumes that the "blackbox" does not contain any physiological disability.

The design of an efficient protocol would go a long way towards improving our knowledge of how students in Management Education should learn certain tasks.

The order of these phases need not be rigidly adhered to. Although the order in which the essential phases

is stated below may be used as a heuristic process intending to facilitate learning more efficiently rather than if the phases were to be treated as combinations.

6:1 THE FIRST ESSENTIAL PHASE IS THAT STUDENTS
SHOULD HAVE THE CORRECT EXEMPLAR OF THE TASK

If we assume that students are motivated to learn a task, then they would have to have an exemplar of what the task is about. This exemplar may either be affirmed or negated at an early point of the learning processes or after a feedback is received from the output of a learner.

The process of affirmation or negation of the exemplar is important to a learner even though a dim cue is given. For example, if management students were to learn costings, they would have to know:

- a) what costings mean — the amount of expenditure (actual or notional) incurred on, or attributable to, a given thing, operation and project — and,
- b) the form: 1) the ways to ascertain the cost of a given thing (a product such that production cost plus selling cost plus distribution cost plus administration cost equal to total cost); 2) the ways to ascertain cost of an operation of say, a business enterprise or institution such that the important areas: labour, materials, variable overheads and fixed overheads make up the operating cost;

and 3) the ways to ascertain the cost of a project or a development program. If the project is for installing a new machine then the cost of the project is made up of the costs of:

- i) machine;
- ii) foundations;
- iii) installation;
- iv) services and
- v) test and rectify.

For a development program, costs of:

- i) research up to the building of the prototype;
- ii) building the first prototype;
- iii) testing and amendment;
- iv) building of the second prototype;
- v) final testing.

If the development were a new product, testing the market would be included.

6:2 THE SECOND ESSENTIAL PHASE IS THE STRUCTURE OF THE TASK

Not all learning tasks are structured, that is to say there are learning tasks which have no universal algorithm or program on how to carry them out in an environment which is changing rapidly. Such learning tasks require a great deal of problem solving, judgement and creativity, and may be termed, in this thesis, unstructured complex tasks.

The following characteristics of unstructured complex tasks may be observed:

- i) Where the tasks are so illusive — learning how and when to diversify by producing an unfamiliar product for an unfamiliar market; learning what the product life cycle might be at a particular point in time i.e stages of development, growth, saturation and decline over a period, which is due to threats from the business environment caused by competition, product obsolescence; learning how to win large sales contracts with China, Soviet Union, Israel and Saudi Arabia; and many localized problems — that the learner might not be able to specify an a priori, about the nature of the ideal way to (success) achieving the goal.
- ii) The goal is not usually defined in terms of either yes or no; "right or wrong" with the use of the exclusive "or (\wedge)", which when put into a symbolic form such as a truth table it reads:

p	q	$p \wedge q$
1	1	0
1	0	1
0	1	1
0	0	0

1 denotes true

0 denotes false.

Instead, the goal is usually expressed in relative terms subject to the actual situations and practical limitations within which the learner or problem solver is working in.

iii) Where if a methodology is found (knowing how) to deal with a particular unstructured task, it does not necessarily constitute sufficient evidence to conclude that that methodology is absolutely correct for knowing how to deal with other unstructured tasks. The problem of judging methodology per se "good" or "bad" has been explained by Lorimer, K.V.(1976) in a paper presented at the European Meeting on Cybernetics and Systems Research, in Vienna.

There exist certain complex tasks (such as inventory control; the allocation of limited resources for distribution; planning a route for a shipping company; scheduling the input/output traffic; how to maximise production with a limited amount of productive resources and other tasks of this kind) for which, some kind of algorithm is developed for each of them. Such tasks may be regarded as structured or/and partially structured tasks.

By algorithm is meant an orderly sequence of instructions containing well defined rules of procedure which if obeyed by a learner, will lead him to a desired goal.

An important characteristic of algorithm for structured or/and partially structured tasks is that it can be developed outside the business enterprise and its environment. This characteristic has the advantage of attracting widespread interest in the task; the structure of the algorithm, and in simulating the algorithm.

Algorithms for many of the structured or partially structured tasks have tended to be mathematically elegant, and sometimes to the point of eccentricity, at the expense of not having any practical value for Management. A reason for this state of affair might be that some academics tend to move further away from the real-world tasks.

6:3 THE THIRD ESSENTIAL PHASE — LEARNING FROM THE DESIGN OF AN ALGORITHM (INDEPENDENT LEARNING)

An algorithm provides rules and regulations for knowing how to carry out a practical task independent of a teacher, and by its execution, encourages self-study in an efficient manner. With such a design the input/output relations of the blackbox approach can easily be rationalized and improved upon. Thus making it more conducive to group learning than to learning by trial and error, which can be very expensive, if not too risky in certain situations.

How should an algorithm be designed depends to a large extent on:

- A) the task, and
- B) an appropriate model of the cognitive processors of the learner.

A) The characteristics of the types of learning task have been examined above, but the following case illustrates the process of designing an algorithm for a practical task.

6:3.A A CHARTERED SHIPPING COMPANY'S PROBLEM IN THE WORLD GRAIN MARKET

A chartered shipping company has been awarded a contract to carry grains from a specified port in country A to port G, which is named by the buyer of the grains. A ship, "M.S. TENNEK" with the appropriate tonnage capacity has been commissioned to transport the grains.

Agreements have been signed allowing the "M.S.TENNEK" to call at any port between territories A to G through which it must call, at least, at one of the ports in each of the territories to collect fresh food, water and other operational materials. The cost of each call including wharfage and demurage has been obtained and worked out by the planning department of this company.

A schedule of costs has been produced by the planning department showing the cost per call for all the ports in each territory, excluding ports A and G whose costs are provided for, in the contract for the grains-purchase.

The executive directors of the chartered shipping company are interested in the production of an instructional schedule containing a route through which the captain of the "M.S. TENNEK" must follow at the optimal cost from A to G.

The researcher has applied dynamic programming as a means of achieving this goal.

6:3.B AN APPROPRIATE MODEL OF THE
(COGNITIVE PROCESSORS OF THE) LEARNERS

A designer of an algorithm should have a model of the cognitive processors of the learners. That is to say, the designer should have a model of the learners. In the chartered shipping company's problem, if a designer's model of the executive directors of this company is based on the notion that they (the executive directors) are graduates with an honours degree in mathematics, say Model A Type then an optimal amount (containing the minimum number of rules and steps) of operations may have to be processed.

On the other hand, if a designer's model of the executive directors of this chartered shipping company is based on evidence from Clark's Report (1966) and statistical extraction and inference which reveal that approximately 70 per cent of the executive directors and managers have limited qualifications and no more than a minimum competence, at the ordinary level of the General Certificate of Education or Ordinary National Certificate. Yet they have experience and other managerial abilities, say Model B Type.

Therefore, an algorithm with the optimal amount of operations for Model A Type may be mentally and operationally too difficult to process by Model B Type. In such a case, it would be expedient to design an algorithm that is longer but simple to process. An algorithm designed for Model B Type develops below.

6:3.1 A GUIDANCE FOR DESIGNING AN ALGORITHM
THE STUDENTS SHOULD HAVE THE CORRECT
EXEMPLAR OF THE TASK (See Phase 1)

This task (6:3.A) is concerned with producing a route which will incur the optimal cost based on a schedule of costs for all the ports which the "M.S.TENNEK" can use.

- .11 The technique to be used is dynamic programming.
- .12 Dynamic programming is a technique developed by Richard Bellman (1957) to deal with multi-dimensional problem. The problem in question is a multi-stage deterministic problem which comes within the scope of dynamic programming.
- .13 The task at hand is structured because the optimal could be found with regards to a schedule of costs. (See Phase 2).
- .14 The behaviour demanded by the situation is to produce:
 - a) an instructional schedule for the captain of the ship "M.S. TENNEK" to follow (as a route) at the optimal cost based on a schedule of costs which is provided by the planning department of the chartered shipping company. And,
 - b) Design an algorithm which is to be executed by Model B Type cognitive processors.

131

.15 Study the relation between facts in context.

.16 Observe points of relevance of the relationship between the variables, and see how they are measured.

In this case the variables are measured in the same way, i.e decimal notations and in integers, which have already been converted into pounds sterling.

Note the conditions and connectives in the problem or learning task. In this case the main conditions are:

i) That the ship must call at least at one of the ports in each of the countries or territories agreed.

ii) This implies that it should not call to any other ports excluded from this list.

iii) The costs of the calls at ports A and G are provided for in the agreement between the vendor and buyer.

iv) It implies that ports A and G have been specified and agreed to, by the vendor and buyer.

v) That the costs are not subject to fluctuations once the ship has started its journey from port A.

vi) That the goal set in 6:3A would be achieved by the design.

.17 Make up an analytical structure of the core of the task i.e a network; or a flow chart or a list structure or branching program of the core of the task.

A network of the core of the task is prepared below, because a list structure will contain too many mathematical computations in the process of deciding which variables to eliminate and which variables to retain in order to arrive at the optimal cost.

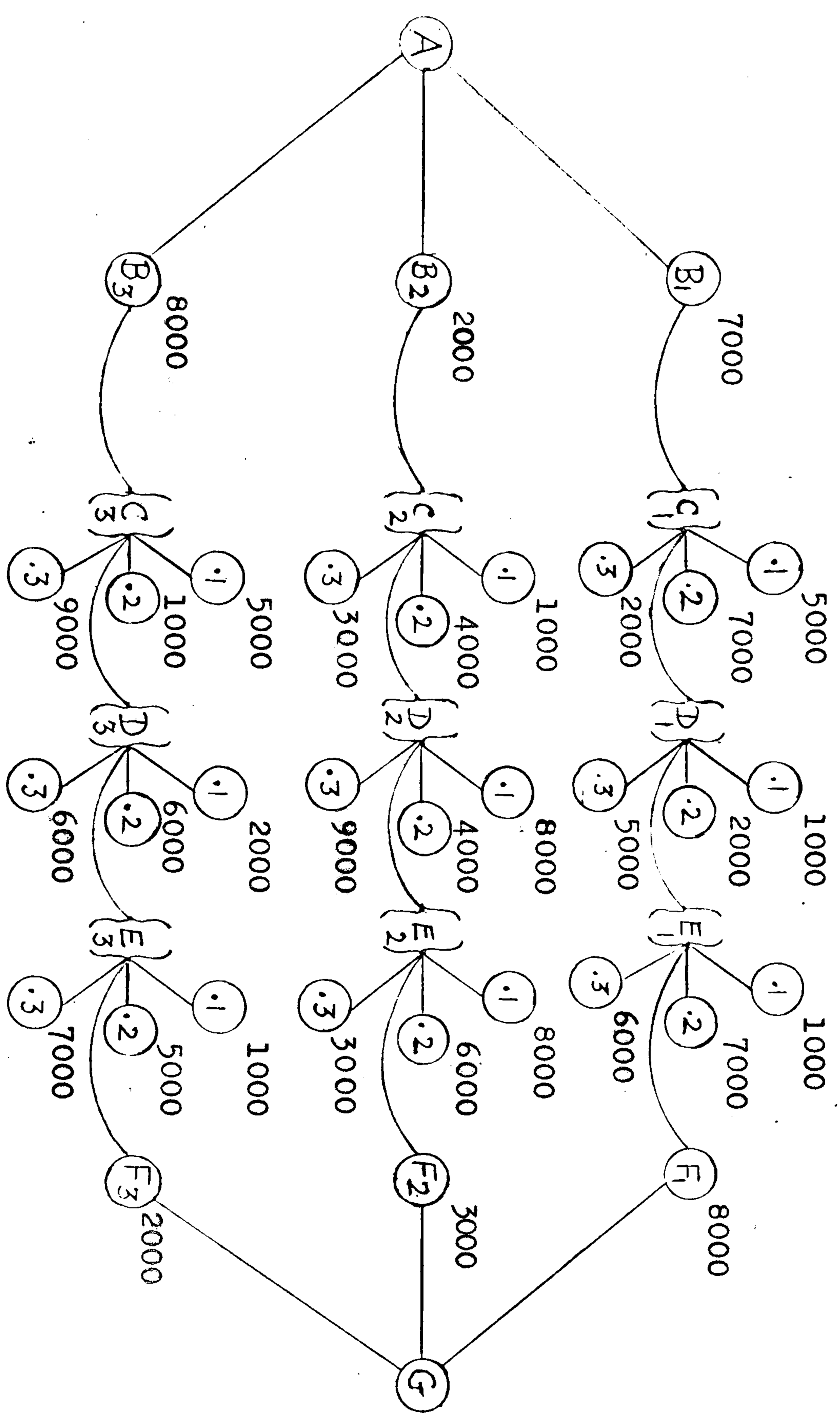

Figure 6:3.18 Network of routes

.19 Is the task capable of decomposition into stages?

Yes.

Number of stages should be arrived at. This may be based on subgoals, sets or sections. Where possible, at least two further levels of decomposition should be made so that subgoals may be further subdivided; sets made into subsets; sections made into subsections. Then at the third level of the decomposition, a subgoal may be subdivided into tactics; a subset may be subdivided into further symmetrical subsets than in the previous subdivisions, and a subsection may be subdivided into operations. The task in question is divided in six stages.

.1/10 Is there any directional characteristic involving an initial point to a terminal point which between them lie the solution process?

For example, in a hierarchical process one can start from general to specifics (vertical, from top to bottom); or from specifics to general (vertical, from bottom to top); columns, starting from left to right or vice versa; rows, starting from left to right or vice versa; horizontal, from left to right — forward or right to left backwards, and many others.

Yes!

A directional characteristic of the solution process in dynamic programming is that the network should be worked through backwards so that the suboptimal cost from any port between A to G can be known.

.1/11 The computational techniques used should be easily recognized and processed by Model B Type cognitive processors. In the task at hand, a decision has to be made whether to use symbols in the recursive formulation or integers. The latter is selected because it is easily recognized by Model B Type cognitive processors.

.1/12 How do the variables effect the outcome at each stage?
At each stage only a small number of variables must effect the outcome of the decisions.

.1/13 What kind of transformation takes place in the multi-stage task?
In the multi-stage decision process in question, decisions are taken at several stages such that a decision taken at the initial stage affects other decisions which are to be made in the solution process. Thus the result of a decision at any stage is merely to alter the numerical values of the small number of variables so that for the next decision along the direction of the solution process, the same variables (with new values) are considered.

.1/14 Build an entailment structure or a logic tree or flow chart or rules followed by example of an algorithm which is to be executed by Model B Type cognitive processors.

6:3.2 GUIDANCE AND RULES FOLLOWED BY EXAMPLES

Rule 1 Inspect network (figure 6:3.18) and prepare to work through the network backwards as in guidance 6:3.1/10.

Rule 2 Divide the network into stages:

Stage 1 F ports to G;

Stage 2 E ports to F;

Stage 3 D ports to E;

Stage 4 C ports to D;

Stage 5 B ports to C; and

Stage 6 from B ports to A.

Rule 3 "An optimal set of decisions has the property that whatever the first decision the remaining decisions must constitute an optimal policy with respect to the outcome which results from the first decision",
Bellman, R.(1952).

Rule 4 Within each stage, we should eliminate the non optimal possibilities returning only to the shortest routes until we get to A.

Rule 5 These guidances and rules should be followed by sets of examples in order to achieve the goal.

EXAMPLESSTAGE 1

F ports to G

From F_1 to G = £8000

" F_2 to G = £3000

" F_3 to G = £2000

Once the "M.S. TENNEK" has arrived at the best route from either sets E_1 , or E_2 or E_3 then the particular port from F_1 , or F_2 , or F_3 would be easily decided, by selecting the lowest cost from the three.

STAGE 2

If E_1 is on the best route the choices are:

From $E_{1.1}$ to F_1 to G = £1000 + 8000 = £9000

" $E_{1.1}$ to F_2 to G = £1000 + 3000 = £4000

" $E_{1.1}$ to F_3 to G = £1000 + 2000 = £3000 *

Eliminate the routes costing the higher and the highest sums of the three: 4000 and 9000

Retain the route which has the lowest cost = £3000

From $E_{1.2}$ to F_1 to G = £7000 + 8000 = £15000

" $E_{1.2}$ to F_2 to G = £7000 + 3000 = £10000

" $E_{1.2}$ to F_3 to G = £7000 + 2000 = £9000 *

Eliminate the routes costing the higher and the highest sums of the three: 10000 and 15000

Retain the route which has the lowest cost = £9000

$$\text{From } E_{1.3} \text{ to } F_1 \text{ to } G = 6000 + 8000 = 14000 \text{ £}$$

$$\text{" } E_{1.3} \text{ to } F_2 \text{ to } G = 6000 + 3000 = 9000$$

$$\text{" } E_{1.3} \text{ to } F_3 \text{ to } G = 6000 + 2000 = 8000 \text{ X}$$

Eliminate the routes costing the higher and the highest sums of the three: 9000 and 14000.

Retain the route which has the lowest cost = £8000

If E_2 is on the best route the choices are:

$$\text{From } E_{2.1} \text{ to } F_1 \text{ to } G = 8000 + 8000 = 16000 \text{ £}$$

$$\text{" } E_{2.1} \text{ to } F_2 \text{ to } G = 8000 + 3000 = 11000$$

$$\text{" } E_{2.1} \text{ to } F_3 \text{ to } G = 8000 + 2000 = 10000 \text{ X}$$

Carry out the process of elimination and retention using the above examples.

Retain the route which has the lowest cost = £10000

$$\text{From } E_{2.2} \text{ to } F_1 \text{ to } G = 6000 + 8000 = 14000 \text{ £}$$

$$\text{" } E_{2.2} \text{ to } F_2 \text{ to } G = 6000 + 3000 = 9000$$

$$\text{" } E_{2.2} \text{ to } F_3 \text{ to } G = 6000 + 2000 = 8000 \text{ X}$$

Carry out the process of elimination and retention using the above examples.

Retain the route which has the lowest cost = £8000

$$\text{From } E_{2.3} \text{ to } F_1 \text{ to } G = 3000 + 8000 = 11000 \text{ £}$$

$$\text{" } E_{2.3} \text{ to } F_2 \text{ to } G = 3000 + 3000 = 6000$$

$$\text{" } E_{2.3} \text{ to } F_3 \text{ to } G = 3000 + 2000 = 5000 \text{ X}$$

Carry out the process of elimination and retention using the above examples.

Retain the route which has the lowest cost = £5000

If E_3 is on the best route then the choices are:

$$\text{From } E_{3.1} \text{ to } F_1 \text{ to } G = 1000 + 8000 = 9000 \text{ £}$$

$$\text{" } E_{3.1} \text{ to } F_2 \text{ to } G = 1000 + 3000 = 4000$$

$$\text{" } E_{3.1} \text{ to } F_3 \text{ to } G = 1000 + 2000 = 3000 \text{ X}$$

Carry out the process of elimination and retention using the above examples.

Retain the route which has the lowest cost = £3000

$$\text{From } E_{3.2} \text{ to } F_1 \text{ to } G = 5000 + 8000 = 13000 \text{ £}$$

$$\text{" } E_{3.2} \text{ to } F_2 \text{ to } G = 5000 + 3000 = 8000$$

$$\text{" } E_{3.2} \text{ to } F_3 \text{ to } G = 5000 + 2000 = 7000 \text{ X}$$

Carry out the process of elimination and retention using the above examples.

Retain the route which has the lowest cost = £7000

From $E_{3.3}$ to F_1 to $G = 7000 + 8000 = 15000$ £

" $E_{3.3}$ to F_3 to $G = 7000 + 3000 = 10000$

" $E_{3.3}$ to F_3 to $G = 7000 + 2000 = 9000$ ✕

Carry out process of elimination and retention using the above examples.

Retain the route which has the lowest cost = £9000

To find the best route at STAGE 2, select the minimum retentions from each set of $\{E_1\}$, $\{E_2\}$ and $\{E_3\}$ such that

$\{E_1\}$: $E_{1.1}$ to F_3 to $G = 3000$ ✕ £

$\{E_2\}$: $E_{2.3}$ to F_3 to $G = 5000$

$\{E_3\}$: $E_{3.1}$ to F_3 to $G = 3000$ ✕

Eliminate the higher and the highest sums and retain the route which has the lowest cost. At this stage a choice of two routes with the lowest costs exists. One of the two choices can be eliminated arbitrarily, but in a practical situation, a preference may be shown for one port against another where some advantage other than cost may be derived. On the basis of the latter information, it is suggested that both choices be open to make an alternative route pattern, bearing in mind the optimal cost.

STAGE 3

D ports should be integrated with
STAGE 2 decisions (best routes).

If D_1 is on the best route the choices are:

From $D_{1.1}$	to $E_{1.1}$	to F_3	to G	=	1000 + 3000	=	4000	£
" $D_{1.2}$	to $E_{1.1}$	to F_3	to G	=	2000 + 3000	=	5000	£
" $D_{1.3}$	to $E_{1.1}$	to F_3	to G	=	5000 + 3000	=	8000	£

Carry out elimination procedure and retain the lowest cost = £4000

Alternative route with $D_{1.1}$

From $D_{1.1}$	to $E_{3.1}$	to F_3	to G	=	1000 + 3000	=	4000	£
" $D_{1.2}$	to $E_{3.1}$	to F_3	to G	=	2000 + 3000	=	5000	£
" $D_{1.3}$	to $E_{3.1}$	to F_3	to G	=	5000 + 3000	=	8000	£

Carry out elimination procedure and retain the lowest cost = £4000

If D_2 is on the best route the choices are:

From $D_{2.1}$	to $E_{1.1}$	to F_3	to G	=	8000 + 3000	=	11000	£
" $D_{2.2}$	to $E_{1.1}$	to F_3	to G	=	4000 + 3000	=	7000	£
" $D_{2.3}$	to $E_{1.1}$	to F_3	to G	=	9000 + 3000	=	12000	£

Carry out elimination procedure and retain the lowest cost = £7000

Alternative route with D₂

From D_{2.1} to E_{3.1} to F₃ to G = 8000 + 3000 = 11000 £
" D_{2.2} to E_{3.1} to F₃ to G = 4000 + 3000 = 7000 ✕
" D_{2.3} to E_{3.1} to F₃ to G = 9000 + 3000 = 12000

Carry out elimination procedure and retain the lowest cost = £7000

If D₃ is on the best route the choices are:

From D_{3.1} to E_{1.1} to F₃ to G = 2000 + 3000 = 5000 ✕
" D_{3.2} to E_{1.1} to F₃ to G = 6000 + 3000 = 9000
" D_{3.3} to E_{1.1} to F₃ to G = 6000 + 3000 = 9000

Carry out elimination procedure and retain the lowest cost = £5000

Alternative route with D₃

From D_{3.1} to E_{3.1} to F₃ to G = 2000 + 3000 = 5000 ✕
" D_{3.2} to E_{3.1} to F₃ to G = 6000 + 3000 = 9000
" D_{3.2} to E_{3.1} to F₃ to G = 6000 + 3000 = 9000

Carry out elimination procedure and retain the lowest cost = £5000

To find the best route at STAGE 3, select the minimum retentions from each set of $\{D_1\}$, $\{D_2\}$ and $\{D_3\}$ such that

$$\{D_1\} : D_{1.1} \text{ to } E_{1.1} \text{ to } F_3 \text{ to } G = 4000 \text{ £}$$

$$\{D_2\} : D_{2.2} \text{ to } E_{1.1} \text{ to } F_3 \text{ to } G = 7000$$

$$\{D_3\} : D_{3.1} \text{ to } E_{1.1} \text{ to } F_3 \text{ to } G = 5000$$

Eliminate the higher and highest sums.

Retain the lowest cost = £4000

To find the best alternative route at STAGE 3, select the minimum retentions from each set of $\{D_1\}$, $\{D_2\}$ and $\{D_3\}$ such that

$$\{D_1\} : D_{1.1} \text{ to } E_{3.1} \text{ to } F_3 \text{ to } G = 4000 \text{ £}$$

$$\{D_2\} : D_{2.2} \text{ to } E_{3.1} \text{ to } F_3 \text{ to } G = 7000$$

$$\{D_3\} : D_{3.1} \text{ to } E_{3.1} \text{ to } F_3 \text{ to } G = 5000$$

Eliminate the higher and highest sums.

Retain the lowest cost = £4000

STAGE 4

C ports should be integrated with STAGE 3
decision (best routes)

If C_1 is on the best route the choices are:

$$\text{From } C_{1.1} \text{ to } D_{1.1} \text{ to } E_{1.1} \text{ to } F_3 \text{ to } G = 5000 + 4000 = 9000 \text{ £}$$

$$\text{" } C_{1.2} \text{ to } D_{1.1} \text{ to } E_{1.1} \text{ to } F_3 \text{ to } G = 7000 + 4000 = 11000$$

$$\text{" } C_{1.3} \text{ to } D_{1.1} \text{ to } E_{1.1} \text{ to } F_3 \text{ to } G = 2000 + 4000 = 6000 \text{ £}$$

Carry out elimination procedure and retain the lowest cost = £6000

Alternative route with C₁

- From C_{1.1} to D_{1.1} to E_{3.1} to F₃ to G = 5000 + 4000 = 9000[£]
- " C_{1.2} to D_{1.1} to E_{3.1} to F₃ to G = 7000 + 4000 = 11000
- " C_{1.3} to D_{1.1} to E_{3.1} to F₃ to G = 2000 + 4000 = 6000*

Carry out elimination procedure and retain the lowest cost = £6000

If C₂ is on the best route the choices are:

- From C_{2.1} to D_{1.1} to E_{1.1} to F₃ to G = 1000 + 4000 = 5000*
- " C_{2.2} to D_{1.1} to E_{1.1} to F₃ to G = 4000 + 4000 = 8000
- " C_{2.3} to D_{1.1} to E_{1.1} to F₃ to G = 3000 + 4000 = 7000

Carry out elimination routine and retain the lowest cost = £5000

Alternative route with C₂

- From C_{2.1} to D_{1.1} to E_{3.1} to F₃ to G = 1000 + 4000 = 5000*
- " C_{2.2} to D_{1.1} to E_{3.1} to F₃ to G = 4000 + 4000 = 8000
- " C_{2.3} to D_{1.1} to E_{3.1} to F₃ to G = 3000 + 4000 = 7000

Carry out elimination routine and retain the lowest cost = £5000

If C₃ is on the best route the choices are:

- From C_{3.1} to D_{1.1} to E_{1.1} to F₃ to G = 5000 + 4000 = 9000[£]
- " C_{3.2} to D_{1.1} to E_{1.1} to F₃ to G = 1000 + 4000 = 5000
- " C_{3.3} to D_{1.1} to E_{1.1} to F₃ to G = 9000 + 4000 = 13000

Carry out elimination routine and retain the lowest cost = £5000

Alternative route with C_3

From $C_{3.1}$ to $D_{1.1}$ to $E_{3.1}$ to F_3 to G = 5000 + 4000 = 9000 £
 " $C_{3.2}$ to $D_{1.1}$ to $E_{3.1}$ to F_3 to G = 1000 + 4000 = 5000*
 " $C_{3.3}$ to $D_{1.1}$ to $E_{3.1}$ to F_3 to G = 9000 + 4000 = 13000

Carry out elimination routine and retain the lowest cost = £5000

To find the best route at STAGE 4, select the minimum retentions from each set of $\{C_1\}$, $\{C_2\}$ and $\{C_3\}$ such that

$\{C_1\}$: $C_{1.3}$ to $D_{1.1}$ to $E_{1.1}$ to F_3 to G = 6000 £
 $\{C_2\}$: $C_{2.1}$ to $D_{1.1}$ to $E_{1.1}$ to F_3 to G = 5000 *
 $\{C_3\}$: $C_{3.2}$ to $D_{1.1}$ to $E_{1.1}$ to F_3 to G = 5000 *

Eliminate the highest sum. Retain the lowest cost = £5000

A further choice of best routes occurs.

To find the best alternative route at STAGE 4, select the minimum retentions from each set of $\{C_1\}$, $\{C_2\}$ and $\{C_3\}$ such that

$\{C_1\}$: $C_{1.3}$ to $D_{1.1}$ to $E_{3.1}$ to F_3 to G = 6000 £
 $\{C_2\}$: $C_{2.1}$ to $D_{1.1}$ to $E_{3.1}$ to F_3 to G = 5000 *
 $\{C_3\}$: $C_{3.2}$ to $D_{1.1}$ to $E_{3.1}$ to F_3 to G = 5000 *

Eliminate the highest sum. Retain the lowest cost = £5000

A further choice of best routes exists.

STAGE 5

B ports should be integrated with STAGE 4
decisions (best routes)

For best route on B the choices are:

$$\text{From } B_1 \text{ to } C_{2.1} \text{ to } D_{1.1} \text{ to } E_{1.1} \text{ to } F_3 \text{ to } G = 7000 + 5000 = 12000 \text{ £}$$

or

$$\text{From } B_1 \text{ to } C_{3.2} \text{ to } D_{1.1} \text{ to } E_{1.1} \text{ to } F_3 \text{ to } G = 7000 + 5000 = 12000$$

B_1 with alternative route from $D_{1.1}$

$$\text{From } B_1 \text{ to } C_{2.1} \text{ to } D_{1.1} \text{ to } E_{3.1} \text{ to } F_3 \text{ to } G = 7000 + 5000 = 12000 \text{ £}$$

or

$$\text{From } B_1 \text{ to } C_{3.2} \text{ to } D_{1.1} \text{ to } E_{3.1} \text{ to } F_3 \text{ to } G = 7000 + 5000 = 12000$$

$$\text{From } B_2 \text{ to } C_{2.1} \text{ to } D_{1.1} \text{ to } E_{1.1} \text{ to } F_3 \text{ to } G = 2000 + 5000 = 7000 \times$$

or

$$\text{From } B_2 \text{ to } C_{3.2} \text{ to } D_{1.1} \text{ to } E_{1.1} \text{ to } F_3 \text{ to } G = 2000 + 5000 = 7000 \times$$

B_2 with alternative route from $D_{1.1}$

$$\text{From } B_2 \text{ to } C_{2.1} \text{ to } D_{1.1} \text{ to } E_{3.1} \text{ to } F_3 \text{ to } G = 2000 + 5000 = 7000 \times$$

or

$$\text{From } B_2 \text{ to } C_{3.2} \text{ to } D_{1.1} \text{ to } E_{3.1} \text{ to } F_3 \text{ to } G = 2000 + 5000 = 7000 \times$$

$$\text{From } B_3 \text{ to } C_{2.1} \text{ to } D_{1.1} \text{ to } E_{1.1} \text{ to } F_3 \text{ to } G = 8000 + 5000 = 13000$$

or

$$\text{From } B_3 \text{ to } C_{3.2} \text{ to } D_{1.1} \text{ to } E_{1.1} \text{ to } F_3 \text{ to } G = 8000 + 5000 = 13000$$

B₃ with alternative route from D_{1.1}

From B₃ to C_{2.1} to D_{1.1} to E_{3.1} to F₃ to G = 8000 + 5000 = 13000

or

From B₃ to C_{3.2} to D_{1.1} to E_{3.1} to F₃ to G = 8000 + 5000 = 13000

Eliminate the higher and highest sums.

Retain the lowest cost = £7000. A second choice from B₂ exists.

To find the best route at STAGE 5, select the minimum retentions from B₁, B₂ and B₃ and discard the higher and highest sums. B₂ is the best route, but a second alternative choice now exists:

From B₂ to C_{2.1} to D_{1.1} to E_{1.1} to F₃ to G = £7000

" B₂ to C_{3.2} to D_{1.1} to E_{1.1} to F₃ to G = 7000

B₂ with alternative route from D_{1.1}

From B₂ to C_{2.1} to D_{1.1} to E_{3.1} to F₃ to G = £7000

" B₂ to C_{3.2} to D_{1.1} to E_{3.1} to F₃ to G = 7000

FINAL STAGE, STAGE 6.

Port A, the terminal point of the computational process should be integrated with STAGE 5 decisions (best routes).

Once the decisions at STAGE 5 are made there is no choice, the next port must be port A. Hence the instructional schedule containing the routes which the "M.S.TENNEK" must follow from port A to G, at the optimal cost which displays four choices.

- From A to B₂ to C_{2.1} to D_{1.1} to E_{1.1} to F₃ to G = £ 7000
- " A to B₂ to C_{3.2} to D_{1.1} to E_{1.1} to F₃ to G = 7000
- " A to B₂ to C_{2.1} to D_{1.1} to E_{3.1} to F₃ to G = 7000
- " A to B₂ to C_{3.2} to D_{1.1} to E_{3.1} to F₃ to G = 7000

See network below, figure 6:3.3

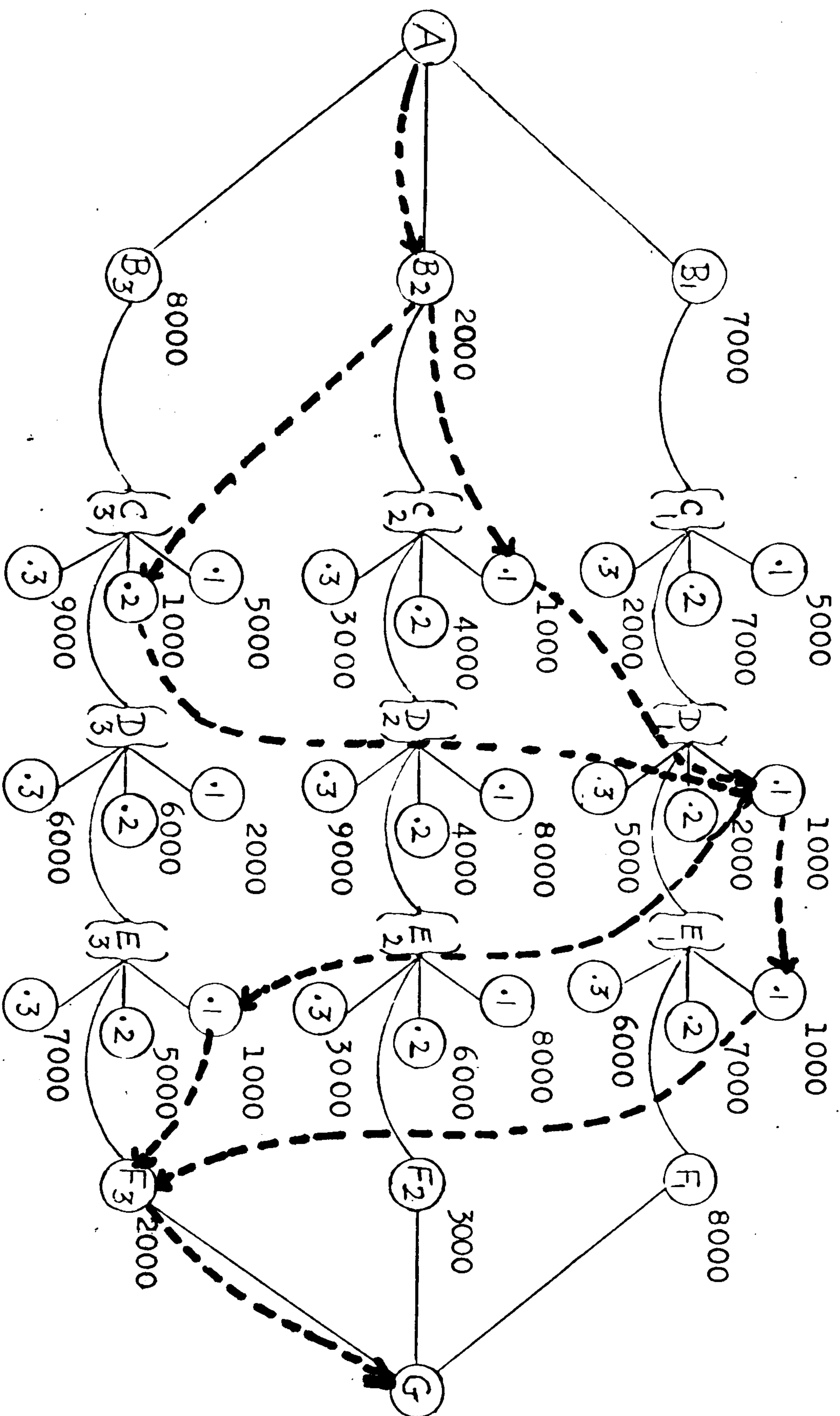

Figure 6:3.30 Network containing schedule and route which the captain of

"M.S. 'TENNEK" must follow in order to achieve the optimal cost.

6:4 THE FOURTH ESSENTIAL PHASE IS KNOWING THE EXTENT OF WHAT IS BEING LEARNT

When an algorithm is well tested it can be given to a junior staff to be applied as a routine. In this event the junior staff need only to know how to apply the routine and whether it achieves the goal or not without having to understand the mathematical proof and why certain computations are done in a certain way and not in other ways.

However, students on an educational program for Management should know to what extent is learning by an algorithm helpful for their future development, and whether exploring by trial and error does not lead to creativity and innovation. To get an indication of the scope of algorithms in learning, students would have to consider:

- a) The purpose for which the knowledge is required;
- b) The intentions of the educational scheme; and
- c) A comparator based on agreement by a consensus or by experts or evidence of worthwhileness.

From this consideration the extent of the scope of algorithms in learning would be known.

6:5 THE FIFTH ESSENTIAL PHASE IS TO HAVE INFORMATION
ON A VARIETY OF THEORIES AND CONCEPTS, AND OF,
SUITABLE ALGORITHMS AVAILABLE BEARING IN MIND
THE CONSTRAINT OF TIME

As the business environment changes and technology advances, so is the proliferation of books and articles on various theories and concepts for solving business problems. Some of the theories and concepts have become notably complicated and less intelligible to managers. The natural reaction of informed managers to this state of affairs is that while they might want to try some of the new theories and concepts available, they (managers) lack the time to study them.

The development of expedient algorithms would reduce the amount of time and effort in studying any of the new theories and concepts available. By following an algorithm managers would be provided with a short cut and a learning path on how a task may be done. Thus saving time and effort.

If an algorithm is robust to cover certain contingencies such as an expansion of routes or changes in the charges as in figure 6:3.A(i) and is of practical value then further interest in a theory or concept can be pursued.

7. INFORMATION PROCESSING AND THE PHASES OF HUMAN LEARNING AND PROBLEM SOLVING

Information processing and the phases of human learning and problem solving have occupied a great deal of the researcher's attention during the period of this research. However, owing to the limitations of time and resources, the researcher has not yet found it possible to propound a theory that is robust and representative of how management students actually process information in the phases of learning a complex task or solving a complex problem. Hence the reason for a concept.

If more is known about information processing by management students then the use of such knowledge, quite apart from understanding more about the "internal mechanisms" themselves, will enable teachers to design the best form of instructions and communication suitable for learning a complex task or sets of complex tasks.

7:1 A REFLECTIVE APPROACH TO LEARNING AND HUMAN PROBLEM SOLVING

Let it be assumed that the "internal mechanism" (the cerebrum and the nervous system) has a direct relation with learned behaviour, although it is not usually open for inspection while the whole system is in operation. Also, let it be assumed that the functioning of the "internal mechanism" does not contain any physiological disability.

755

Given these assumptions, a prima facie case is made for a reflective concept of learning. By the term, "reflective" is meant the reflection of thoughts and ideas of the learner connected to learning a task or to solving a problem or making a decision. By the term, "a concept" is meant a network of ideas and inferences which go beyond a set of observed properties exhibited by a learner to the class identity of the learner, and hence to inferences about other unobserved properties of the learner. With a reflective concept of learning, the investigator learns from a learner's verbalization and recordings of the reflection of thoughts and ideas connected to learning a task or sets of tasks. Thus it can be argued that it is from this approach to learning that the knowledge of how management students actually learn a particular task or sets of tasks is obtained.

Research in information processing in learning, using a reflective concept called process tracing has been done by many eminent scholars with varying degrees of success.

De Groot, A.(1965) used process tracing method to investigate the thought processes of chess players. He asked various chess players to think aloud as they weigh or contemplate their next moves. He then collected the verbal protocols of their subsequent thoughts as they contemplate alternative moves and consequences. These events led to a model of the chess players' strategies from which a computer simulation developed.

Newell, A; Shaw, J.C. and Simon, H.(1958) in "Elements of a Theory of Human Problem Solving", and Newell, A.

and Simon, H.(1972) in "Human Problem Solving", used process tracing and an Information Processing System (IPS) to develop a theory of human problem solving. The problem solvers' task was to find a set of legal moves that will transform the opening position to a desired goal. The researchers worked within the task environments of symbolic logic, cryptarithmic and developing a program capable of discovering proofs for theorms in elementary symbolic logic. A digital computer was used to simulate the process of problem solving and the two main points of their findings are consider below.

1. "We obtain several important pieces of evidence that the program of L.T (Logic Theory) is qualitatively like that of a human faced with the same task". And,

2. "The second important fact that emerges from the experiments is that LT's success depends in a very sensitive way upon the order in which problems are presented to it. When the sequence is arranged so that before any particular problem is reached some potentially helpful intermediate results have already been obtained, then the task is easy. It can be made progressively harder by skipping more and more of these intermediate stepping-stones..... All of these results are easily reproduced in the laboratory with humans.

Clarkson, G.P.E.(1962) used process tracing to develop a decision theory for portfolio selection. Clarkson began his study with a general framework of portfolio investment decisions which he developed with the help of a trust investment officer. His research was concentrated around one trust investment officer.

Clarkson carefully examined historical records of several of the trust investment officers' accounts, and built a model of what was actually done. He then collected verbal protocols of the officer's thoughts and decisions while the officer worked on a set of accounts within the course of his current activity. Clarkson then developed a "prior state" model describing the trust investment officer's formulation of expectations; information on the valuation of the various stocks, and a general conception of good portfolio characteristics. He also collected data on comments arising from journals and articles which were read aloud by the trust investment officer under study. His model successfully matched actual portfolio selected by the trust investment officer during a six months period.

The method of building a model of the strategies used by chess players then writing a computer program on theorem proving or problem-solving; or simulating a model of the portfolio selection of one trust investment officer then testing the model for statistical validity and reliability with the use of a digital computer, is sound as a basis for simulation. But, to conclude from the findings in the research works mentioned in section [7:1] above that a human being, such

750

as a manager actually process information in the manner specified in their research publications for learning a complex task or solving a complex problem, would be a serious mistake. How far their findings are helpful in understanding how people solve a problem or learn a complex task is an interesting question. The answer to this question is as follows:

- i) They are helpful in knowing more about the structure of the task, and the problem space associated with the game of chess;
- ii) The framework within the simulated model of the trust investment officer may be helpful for training potential trust investment officers working with the same type of portfolios and in the same type of environment;
- iii) They are helpful in that the knowledge gained in writing the programs has contributed to an improvement in the software development such as the General Purpose Systems Simulator (GPSS) and the General Problem Solver (GPS) which have become popular with non specialist users;
- iv) The results of the research efforts by Newell, A; Shaw, J.C; and Simon, H.(1958 and 1972) were helpful in that result 2 provided confirmation that the order of instructions and sizes of chunks of knowledge were important factors in

75

solving problems. Moreover, it would also be a serious mistake to infer that managers or management students would actually process information in the same ways, and would use the identical form of logic to that which was used in their programs to solve real-world complex problems or for learning a complex task. The reasons for this assertion being:

- a) that the tasks selected by the eminent scholars mentioned above are too restricted, and the environments within which these tasks had been studied had too many constraints;
- b) that the components of the models of the problem solvers, or decision-makers were insufficient to represent the cognitive processors of the human being faced with a complex problem; and
- c) that the logic; program structure, and the structure of information processing by a digital computer are not identical to the logic; structure, and methods of information processing by human beings.

758

7:2 SOME ESSENTIALS IN MODELLING THE PHASES AND
PROCESSES IN HUMAN LEARNING AND PROBLEM SOLVING
WITH SPECIAL REFERENCE TO MANAGEMENT STUDENTS

In order to have a realistic model or theory of the phases and processes of human learning and problem solving, a model must include as its components four important phenomena which the researcher considers essential.

The phenomena are:

1. That the learning or problem solving task should not be too restrictive or confined to chess playing programs. Instead, the task should have potential applications to real-world problems of technology and organisation and not just puzzles.

2. The environment within which a task is being learnt or problem solved must be represented in realistic terms. That is to say, where a goal is set in a theoretical environment, it may require a response in absolute terms, allowing very little deviation from the ideal goal. Whereas in a practical situation, the forces within the environment may not be easily manipulated by the learner or problem-solver. In such a situation, the ideal goal may be too costly and impracticable, thus giving rise to a goal relative to the state of the environment or a minimum acceptable goal-criterion. Further, the behaviour of a learner or problem-solver may be coupled to the real environment in which he is being prepared for. The ultimate indicator of whether management students have learnt from his education, experiences and so on, is to observe how they behave (adapt)

in the real world environment and whether they can achieve a relative standard or minimum acceptable standard of efficiency in a changing environment.

3. The Model of the learner or problem solver should contain sufficient cognitive components to reflect the class of human beings. In this thesis, the class of human beings are adult learners and problem-solvers. Some essential characteristics of the cognitive components of an adult learner are:

- a) An adult learner has to be motivated towards a goal and be adaptive to change,
- b) The adult learner has an operational belief system which is capable of influencing his perceptual discrimination. Though information reduces ignorance or uncertainty about a state of knowledge, a negative belief of a certain "X" can affect the rate of learning significantly, and
- c) The adult learner must have certain pre-requisites or minimum entry requirements i.e language and knowledge, to enter the learning phase.

4. The memory of the human being must be represented as a "whole cognitive system".

The memory of a digital computer — the storage location that can be immediately addressed by the program controller of the central processor — and its operations in relation to the process of information is not identical to that of the human being. Instead, it represents a logical part of, which is not equivalent to, the human memory.

16

The capacity (millions of digits or characters or bytes) and design of the memory of a digital computer may affect the method in which the data is processed by the system. The address codes have to be very precise, and access to these codes depends on; (a) the program and (b) the kind of storage devices.

It is conceived that the memory of a management student consists of a short-term memory and a conceptual long-term memory. The short-term memory receives information from a perceptual unit (involves the process of initial categorization or having an exemplar of the task); transfers items to the conceptual long-term memory; holds items for conversion and output control, and carries out physiological functions including reflex actions and motor co-ordination.

The conceptual long-term memory has an infinite memory capacity and made up essentially from experience, knowledge by description, training, reading and self-development within a variety of environments over a period. The address codes are not so rigorously ordered as in the case of the digital computer. Yet, not only can the human being process information in a serial, or a sequential, or a selective sequential or a random mode, but in addition, the human being can access data in a parallel manner; in a simultaneous manner, and in a chaining manner, using different locations depending on:

- a) a universal set of discourse;
- b) the environment; and
- c) purposeful behaviour.

7:3 PHASES AND PROCESSES OF HUMAN LEARNING AND PROBLEM SOLVING

After considering the essential phenomena for a realistic model, a student or manager when presented with a case study or a complex problem has to go through the following phases and execute certain processes in order to reach a goal. The researcher conceives these phases to be as follows:

The first phase is to recognize the learning task from the description and data available. Here the consideration of natural language must be taken into account, because to know involves understanding what is being communicated, and verbalising and reporting one's thought has to be done in a language which is understood by others.

The process of recognition may involve a search of the conceptual long-term memory to see whether there is an exemplar to match the task. If there is no easily matched exemplar, or the exemplar differs from the true meaning or operational meaning and form, of the learning task then a cue search takes place. The latter involves the student searching the description of the learning task and data available and the environment for cues in a situation where information or entropy is relatively high.

The second phase involves finding the correct exemplar which may be obtained from the cue search and clues received about the correctness or approximate correctness of the exemplar. Once this process is completed the entropy is

gradually reduced.

The third phase involves an analysis of the task either in a hierarchical manner from general to specific or sets of separate parts conjoining to take up a complex task relative to their context.

The fourth phase involves A the relationships between (i) the whole and its parts; (ii) parts and parts; (iii) all and some, and B the inferences relative to A and beyond, in producing the composite response to the goal. It is contended that the solution path is concealed within these relationships. Thus the bulk of the conversion and information processing in human learning and problem solving involves making the correct chains of relationships in response to a purposeful behaviour or for solving a problem.

A (i) The relationship between a whole and its parts may follow from either a conceptual analysis of general to specific ideas or from a deductive analysis. This kind of relationship varies such as:

A transitive relationship with enclosure.

In such instances where greater than ($>$) or "inclusive of", or "included in" (\subset) can be made. So that if $X > Y$ and $Y > Z$ then $X > Z$.

Suppose that an analysis is made of total cost in a manufacturing enterprise then a transitive relationship may be made up in the following way.

Let T.C = Total Cost;
 C.Prod = Cost of Production;
 Mf.C = Manufacturing Costs, and
 P.C = Prime Cost.

Thus $P.C \subset Mf.C \subset C.Prod \subset T.C$

There could be an asymmetrical relationship between whole and parts. This may occur where different groups or parts are attached to a whole and one of the parts has a higher valency in priority or is more reactive to the goal of a task than the other parts.

A functional relationship may exist between a whole and its parts. This may occur where a system displays a type of behaviour which is a member of a class of behaviour. For example telegraphy; telephony; radio transmission; satellite transmission and reception have the function of communicating signals. Another functional relationship may exist where a number of co-ordinated activities are designed to do a particular work. A design of a set of activities such as market research, advertising and sales promotion, distribution and selling may make up the marketing function of a business organisation.

A (ii) The relationship between parts and parts may occur in the following ways:

A set and its complement. In a universal set of discourse (U) there exists a set (A) and its complement, (A').

Suppose that a case study requires a decision on whether to advertise a certain household product on Thames Television or use another medium. If we have the tariff rate of charges and times and estimates of the viewing audience, then one has to consider the characteristics of the set, and its complement. Thus the characteristics of the set is defined by:

- 1) those audience viewing television at a certain time when the advertisement will appear,
- 2) those people living within the Thames Television region, and
- 3) those people who look at television.

The complement (A') includes:

- 1) those audience having a television and those who look at television but cannot view television at the time when the advertisement will appear;
- 2) those people who have television and those who look at television at a time when the advertisement will appear but are outside the Thames Television area;
- 3) those people who do not have a television nor look at television as a normal social activity, and
- 4) all other characteristics which are not a member of the set (A).

A time relationship may be made between parts and parts. This requires memory and recognition within a duration. For example, events that occur but over a duration they might make up parts of a plan or a strategy.

162

A spatial relationship may be made between parts and parts. The putting together of sales territories to determine the sales force call-patterns and number of sales force required forms an important spatial relationship which must be considered in managing the sales force of a company.

A (iii) A relationship between all and some is often made by the use of the logical product or the intersection of two classes.

The characteristics of such a relationship are:

- a) that it depicts a set of elements that are common to two or more sets;
- b) that it defines the relationship between all and some, and
- c) it might explain the reasons behind a decision or factors contributing to a response to a particular situation. An illustration of this relationship develops.

In the present economic austerity, some managers are now members of the Association of Scientific Technical and Managerial Staffs (ASTMS), which is a trade union and a member of the Trade Union Congress (TUC).

Suppose that company Y has to negotiate a productivity agreement brought about by a board of directors' decision to deepen the capital structure by installing new capital equipment which would not require as many direct labour as at present. This would also have consequences for those supervisors connected with the supervision of direct labour and indirectly, with other supervisors. Assume that a negotiating team on behalf of the members of company Y is to be appointed from the managerial staff of which some of its members are members of the ASTMS. The company's negotiating team will have the

authority to negotiate with the productive workers and their unions, as well as with supervisors.

In such a situation the following relationship may arise:

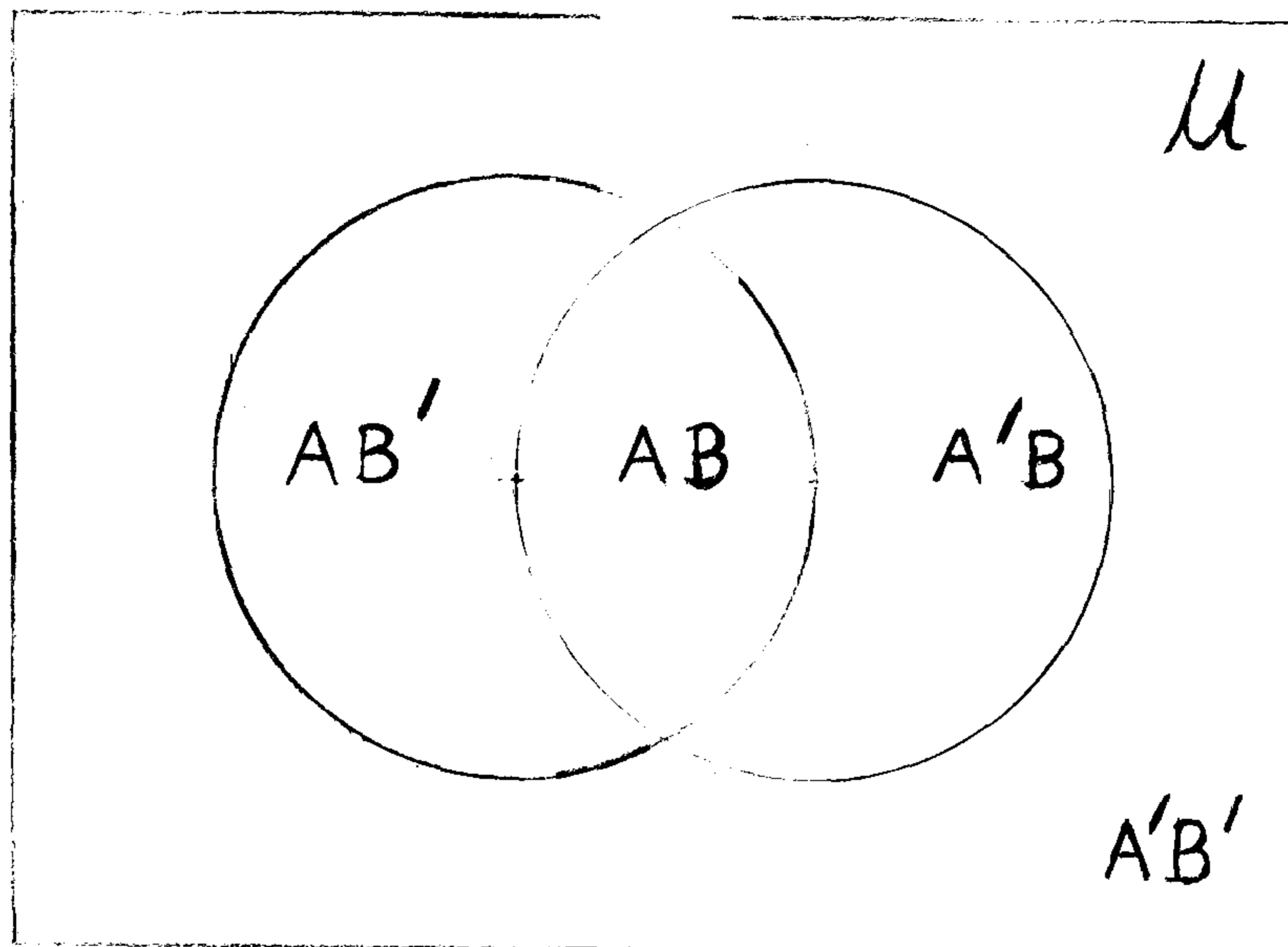

Figure 7:3.1 A Venn diagram showing the logical product AB and complements.

AB = Managers who are both members of (the ASTMS), a trade union and members of a management negotiating team;

AB' = Managers who are members of (the ASTMS), a trade union, but not members of a management negotiating team;

$A'B$ = Managers who are not members of (the ASTMS), a trade union, but are members of a management negotiating team; and,

$A'B'$ = Managers who are neither members of (the ASTMS), a trade union, nor members of the management negotiating team.

B The inferences relative to the variety of relationships
 described and illustrated above, under subsection A of this chapter play an important role in human learning and problem solving. They provide the bridge for mental leaps which are frequent in creative work.

The relationships and inferences make up the transformation rules by which new beliefs; new concepts; new principles and new theories may be derived from old ones. They form the basis of the learning and solution path which may also be associated with logical transformations.

Given a case study, if the exemplar from the case materials is correct, and the correct relationships are chained to the exemplar then the probability of the logical consequence being correct is greater than if the exemplar is correct, but the chained relationships are false or if the exemplar is false and the chained relationships are false.

In the context of human learning and problem solving, a consequence may be reasonable or/and logical, provided that the exemplar is correct and the chained relationships and inferences are correct. Some examples of reasonable consequences are developed hereunder.

1. An increase in assets in a given year constitutes growth.

Some increase in investment on Research and Development (R&D) and Marketing are growth creating areas.

Therefore, some growth creating areas are R & D and Marketing.

2. All managers have an interest in continuity of employment.

Some managers lose continuity in employment when a take-over of their company occurs which may be due to low current earnings and share prices.

Therefore, low current earnings and share prices are likely to bring about a take-over and some managers will lose continuity of employment.

The fifth phase involves placing the composite response against a comparator to obtain knowledge of results (feedback) or submitting the composite response and explanations for a consensus on whether the goal has been achieved. And,

The sixth phase, involves a re-enforcement process which a learner or problem solver goes through. If the outcome of a learner reaches the value of his expectations then this may act as confirmation of his expectations and provide a basis for subsequent action. If the outcome of a learner or problem solver does not reach the value of his expectation this may give rise to a re-opening of the problem of choice and a further search may be made for improvement in the solution path. If the problem of choice is not resolved or an improvement cannot be made then the task may be

167

regarded as partly achieved in which case a degree of conformation would be arrived at by the learner or problem solver. On the other hand the task may be abandon and regarded as unsuccessful or unsolved.

A robust theory of th phases and processes of human learning and problem solving would require many years of future research, which depends to a large extent on research funding and adequate resources. The existing method of process tracing should be extended to include research into:

- i) directive and non directive questionning by researchers, and
- ii) the uses of a wider variety of communication modes to represent the verbal, spatial, iconic and creative signals during the process of learning a complex task or solving a complex problem than those used by many eminent scholars.

DESIGNING A WHOLE CURRICULUM
FOR MANAGEMENT EDUCATION
WITH AN OPERATIONS SYSTEM

170

8. DESIGNING A WHOLE CURRICULUM FOR
MANAGEMENT EDUCATION WITH AN OPERATIONS SYSTEM

A design of a "whole-curriculum" intending to prepare post-graduate and post-experience men and women for a profession in management for industry, commerce, the public service and other establishments is developed in this section. It is the intention of the researcher that such a design would lead to the development of an educational program for a master's degree in Management.

The term "whole-curriculum", as used in this thesis, means a formal management educational scheme which contains a program of important and essential areas of knowledge and experiences in Management of which, many men and women will be deprived unless a university or educational institution provides them. This definition recognizes the fact that there are other areas of knowledge and experiences of life, business transactions and social events in society which can be learnt (through reading, observing and having an acquaintance with a thing or situation in the community) without having to be a student on a formal management educational scheme. Yet this recognition does not invalidate society's need to provide (plan and organize) those essential areas of knowledge and experiences in Management so that they can be achieved directly by teaching and learning. For a formal educational scheme in management will provide men and women, post-graduate and post-experience with essential areas of knowledge and experiences for Management in a shorter time-span than by an evolutionary

171
development.

The foregoing design is based on the thesis that a "whole-curriculum" should aim at some extrinsic purpose and that there are certain essential forms of knowledge and experiences which should make up the content of a whole curriculum for Management Education. Further, by merely selecting the appropriate content of knowledge and experiences does not constitute sufficient cause to effect the "whole-curriculum's" intention. Thus, for sufficient cause to be present, there should be:

1. An integrated program of sets of coherent modules whose goals or vectors are so designed as to lead students to the purpose of that "whole-curriculum" and,
2. A regular relation (not an ad hoc relation) within the scheme. This will be effected by the establishment of an operations system, called SYSTEM TWO, which is designed to hold the sets of modules together, and with the authority of the program director or head of department, organize and effect a schedule of the teaching, learning and other resources to achieve the purpose of the "whole-curriculum".

MODULE AND ITS MEANING

A module is a term which describes a particular way of organising forms of knowledge and experience as a set, which

17

makes up a part of the structure of an educational program. Thus an educational program may be made up of sets of modules. A set may also be called a unit-course, so that the terms "module" and a "unit-course" will be taken to be synonymous.

The advantages of structuring the program into modules are:

- 1) A module allows teachers to respond to changes in the nature of a discipline by admitting new knowledge without having to demolish the structure of a whole curriculum;
- 2) A module may be replaced and new areas of work may be gradually built-up to meet real-world situations without impediments which may be due to administrative categorization of knowledge;
- 3) Modules tend to provide teaching/learning situations which are conducive to cross-fertilisation of ideas, insights and experiences. Such situations are common in the act of managing, and
- 4) A program made up of sets of modules would positively encourage the use of credits and periodic assessments which are more in tune with the concept of feedback or knowledge of results than a conventional program which employs the use of written three-hourly unseen examinations at the end of the program.

Credits for instructional modules as well as the self-development module, are calculated at a rate of forty hours per credit less one week's relaxation time.

The relaxation time is the estimated time that it would take the teaching and learning systems to settle down, taking into account adjustments of schedule on rooms allocation; students' orientation and settling their personal problems. Thus, for a basic module with eleven weeks duration will be:

11 x 10; ten hours, being a predetermined time per week or minimum amount of study time involved in an instructional module, per week.

such that 11 x 10	= 110 hours
Less 1 week for relaxation time	= $\frac{10}{100}$ "
At a rate of 40 hours per credit	= $\frac{100}{40} = 2\frac{1}{2}$ credits

The predetermined time for the operations module is based on a minimum 35 hours per week employment

Thus, for twelve weeks duration: 12 x 35	= 420 hours
Less 1 week for relaxation time	= $\frac{35}{385}$ "
Plus 1 week for preparation of report	= 35 "
Plus 1 week for internship with SYSTEM TWO	= $\frac{10}{430}$ "

At the rate of 40 hours per credit will be: = $\frac{430}{40} = 10.75$

Approximately 11 credits.



Figure 8/01 denotes a diagrammatic representation of the scheme and its intended transformations upon students.

The use of "modules" to make up the type of educational program proposed in this thesis should not be misunderstood with other types of educational program, called the "cafeteria" system or/and a modular system which are both common in undergraduate studies and purport to be aimed at a broad-based education. With those types of educational program an individual student is able to make up his own program or fill his program-basket from a wide variety of modules.

The modules that make up the educational program in this thesis are coherent modules and are held together by a regular relation which is effected by an operation system, called SYSTEM TWO. The design of a management educational program is set forth below.

Figure 8/01 denotes a diagrammatic representation of the scheme. It shows a student, S_0 , entering the program whereupon he or she is operated upon by the educational systems through a program consisting of sets of integrated modules resting on four basic modules. These basic modules contain the five essential elements (empiricism, logics of reasoning, communication, social developments and events, and morals) which constitute a base for an adaptive management educational program.

FIGURE 8:10 DENOTES A DIAGRAMMATIC REPRESENTATION OF THE BASIC MODULES CONTAINING THE FIVE ESSENTIAL ELEMENTS UPON WHICH AN ADAPTIVE MANAGEMENT EDUCATIONAL PROGRAM MAY BE BUILT.

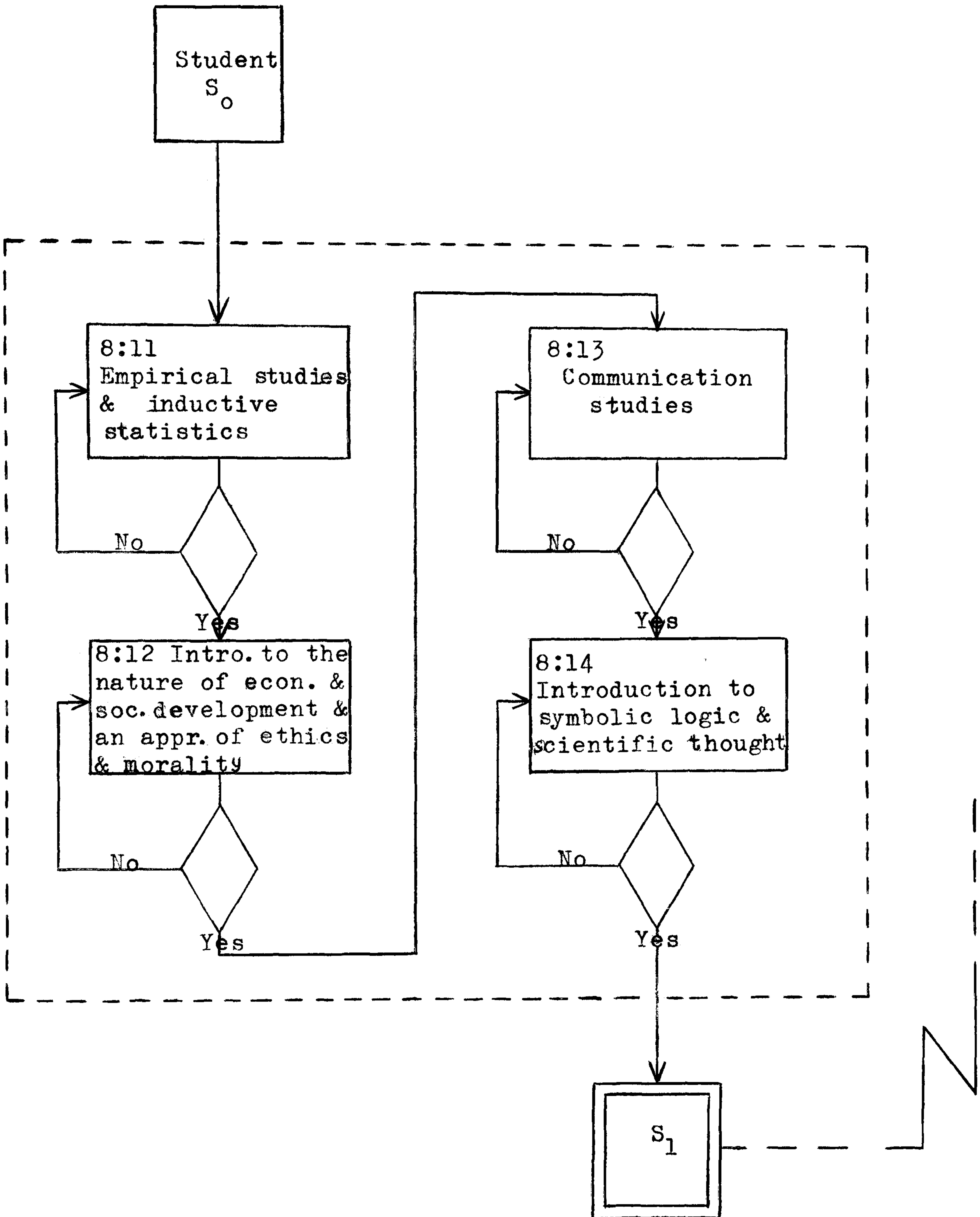

8:11 EMPIRICAL STUDIES AND INDUCTIVE STATISTICS

This module or unit-course gives students:

- a) an understanding of the meaning of empiricism and its place in science and technology, and
- b) a grasp of inductive statistics which is amenable to quantitative analysis. This form of knowledge covers: Recording observations; sampling distributions; statistical inferences and problems of estimation; test of hypotheses; time series and forecasting trends; analysis of variance, and correlation.

This module requires a minimum of 10 hours per week study including 3 hours instructions and tutorials.

Assessment will be done on a periodic basis having reference to the attainment of a satisfactory standard measured from responses to specifically designed assignments.

Two and a half credits will be awarded for successful completion of this module.

8:12 AN INTRODUCTION TO THE NATURE OF ECONOMIC
AND SOCIAL DEVELOPMENTS, AND AN APPRECIATION
OF ETHICS AND MORALITY

This module gives students:

- a) an introduction to the nature of economic and social developments and events, which covers current economic policy of the government; monetary policy and the nature and effects of inflation; taxation policy and government budgeting. National Income Accounting; and economic theory of free enterprise and the market structure. Social events and unemployment; the nature of an industrial organisation as a unitary system; the industrial organisation as a pluralistic system, and the state of industrial relations. And,
- b) an appreciation of ethical and moral considerations. The human character and conduct, and the meaning of "good", "bad", "right", "wrong", and "immorality" are of immediate concern. This concern is legitimate when we look at the development, uses and impact of technology in our society at the present time.

This module requires a minimum of 10 hours per week study including 3 hours instructions and tutorials.

Assessment will be done on a periodic basis having reference to the attainment of a satisfactory standard

179

measured from responses to specifically designed assignments.

Two and a half credits will be awarded for successful completion of this module.

8:13 COMMUNICATION STUDIES

This module gives students a grounding in:

- a) communication science, man-machine communication; communication systems and technology;
- b) human communication, and
- c) the role of communication in society.

The form of knowledge covers analytical communication studies, Shannon and Weaver's model of communication; languages and communication; one to one communication; one to many communication, group communication and human behaviour; communication and attitudes; communication of wants; audio-visual communication; communications media, communications network and systems cost evaluation of effective communication.

This module requires a minimum of 10 hours per week study including 3 hours instructions and tutorials.

Assessment will be done on a periodic basis having reference to the attainment of a satisfactory standard

186

measured from responses to specifically designed assignments.

Two and a half credits will be awarded for successful completion of this module.

8:14 INTRODUCTION TO SYMBOLIC LOGIC AND SCIENTIFIC THOUGHT

This module provides:

- a) a short introduction to symbolic logic, which constitutes an essential form of knowledge for scientific thinking and logical thought;
- b) an appreciation of set theory and number systems, and
- c) grounding for understanding the digital computer.

The module covers a short introduction to symbolic logic; uses of symbols; logical forms, inferences and implications; calculus of propositions; premises, arguments and syllogisms; axiomatic methods and elements of predicated calculus; set theory and number systems; bifurcation, logic tree and algorithm; and binary arithmetic.

This module requires a minimum of 10 hours per week study including 3 hours instructions and tutorials.

Assessment will be done on a periodic basis having reference to the attainment of a satisfactory standard

measured from responses to specifically designed assignments.

Two and a half credits will be awarded for successful completion of this module.

FIGURE 8:20 DENOTES FOUR MODULES WHICH CONTAIN FIRST LEVEL KNOWLEDGE OF THE ESSENTIALS OF MANAGEMENT IN THE REAL-WORLD.

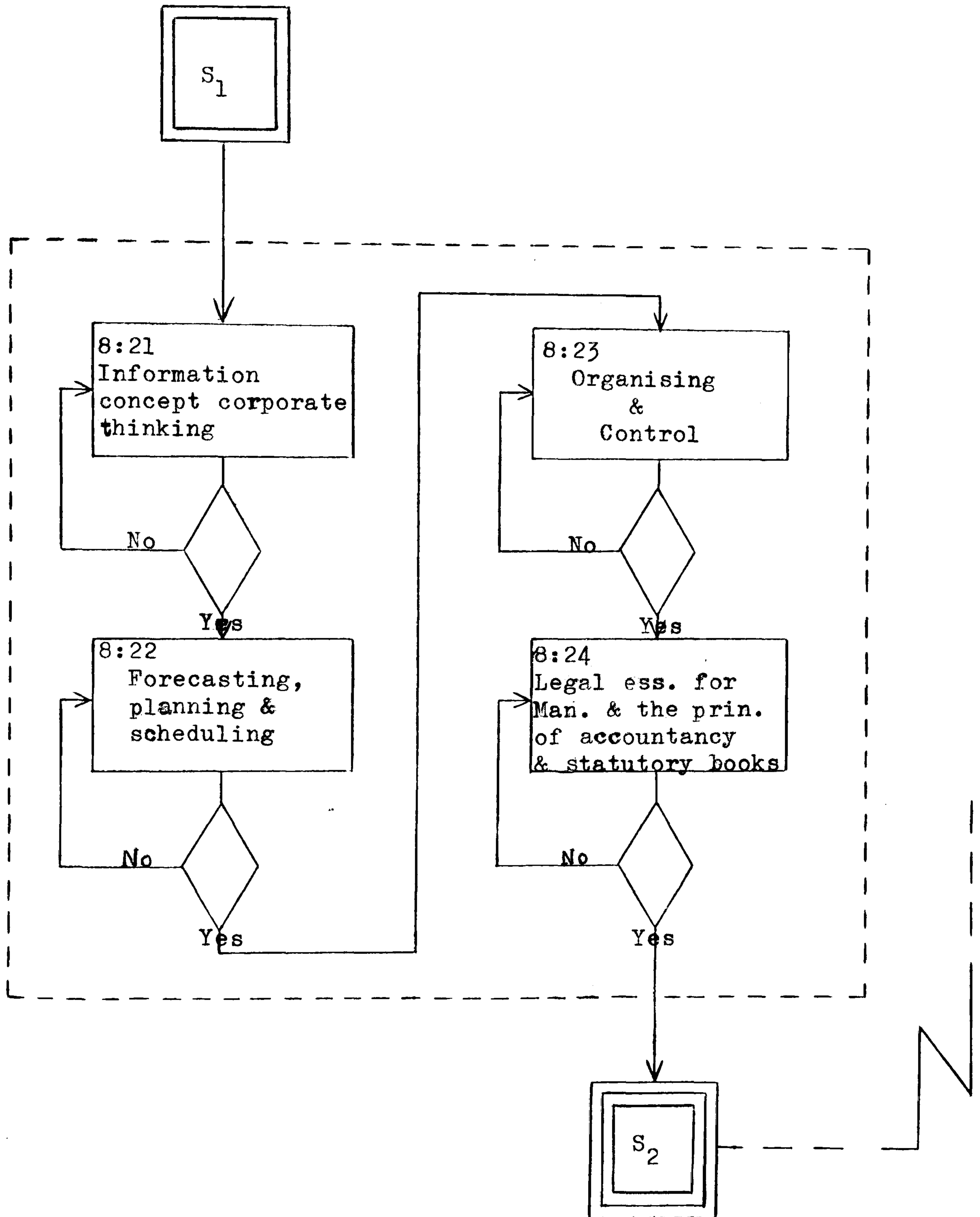

8:21 INFORMATION CONCEPT AND CORPORATE THINKING

This module provides students with an understanding of:

- a) the concept of information and its relations to b) and c).
- b) the process of human problem solving, and
- c) knowledge of "corporate thinking".

The content of the module is as follows:

information concept and entropy; the concept of information as an instrument for providing news, instruction, motivation and intelligence; the relevance of information to the process of human problem solving and decision-making in the real-world; corporate thinking and the dimensions of managerial decisions including quantitative, qualitative, individual, dialectical and co-operative decisions; strategic formulation; games and simulation for strategic, managerial and operational decisions.

This module requires a minimum of 10 hours per week study including 3 hours of instructions and tutorials.

Assessment will be done periodically having reference to the attainment of a satisfactory standard measured from responses to specific assignments.

Three credits will be awarded for the successful completion of this module.

8:22 FORECASTING, PLANNING & SCHEDULING

This module would give students a grounding in the principles and practice of forecasting and planning, which are necessary activities of Management.

The content of this module is as follows:

The principles of forecasting and their relations with planning and action; forecasting methods; creative and consensus forecasting including the delphi method; historical and comparative analogies; and trend extrapolations.

Principles of planning and their relations to forecasting and action; hierarchy of planning; capital and cash budgeting, revenue budgeting, planning for survival; planning for growth; planning for diversification; project planning and scheduling; planning for optimality; planning for minimum acceptable values; planning models for potentials, capability and actuals.

This module requires a minimum of 10 hours per week study including 3 hours of instructions and tutorials.

Assessment will be done periodically having reference to the attainment of a satisfactory standard measured from responses to specific assignments.

Three credits will be awarded for the successful completion of this module.

8:23 ORGANISATION AND CONTROL

This module gives students a grounding in the nature of organisation and control, which are necessary activities of Management.

The content of this module is as follows:

Co-ordination and conflict resolution; methods of supervision and leadership; work measurement; job evaluation and job description; terms and conditions of employment; negotiating with employees on work standards and job improvement; human relation — individual and group studies — motivation.

Data processing for managerial and business time-span.

The mechanisms of control: variety, regulation, feedback; homeostatis and ultra-stability; input/output control; production control; control in industrial processes; computer control and automation; models of managerial control.

This module requires a minimum of 10 hours per week study including 3 hours of instructions and tutorials.

Assessment will be done periodically having reference to the attainment of a satisfactory standard measured from responses to specific assignments.

Three credits will be awarded for the successful completion of this module.

8:24 LEGAL ESSENTIALS FOR MANAGEMENT AND THE PRINCIPLES
OF ACCOUNTANCY AND THE STATUTORY BOOKS

This module provides students with:

- a) an appreciation of the legal essentials for Management and
- b) a grasp of the principles of accountancy in a concise manner so that they may understand the principles involved and interpret accounting statements.

The content of this module is as follows:

An introduction to the laws of incorporation and kinds of companies; memorandum of associations and articles of associations; essentials of the Companies Act 1948 and 1967; essentials and guidance about factories and office premises legislations.

An introduction to the principles of accounting; statutory books; books of accounts; ledger balances and the trial balance; trading and profit and loss account; appropriation accounts and balance sheets, adjustments, depreciation; provisions and reserves; accounting ratios and interpretation of accounting statements.

This module requires a minimum of 10 hours per week study including 3 hours of instructions and tutorials.

Assessment will be done periodically having reference to the attainment of a satisfactory standard measured

from responses to specific assignments.

Three credits will be awarded for the successful completion of this module.

FIGURE 8:30 DENOTES THE MODULES WHICH INTRODUCE STUDENTS TO OBSERVE AND STUDY THE BUSINESS ENVIRONMENT AND CURRENT TOPICS AND ISSUES IN MANAGEMENT.

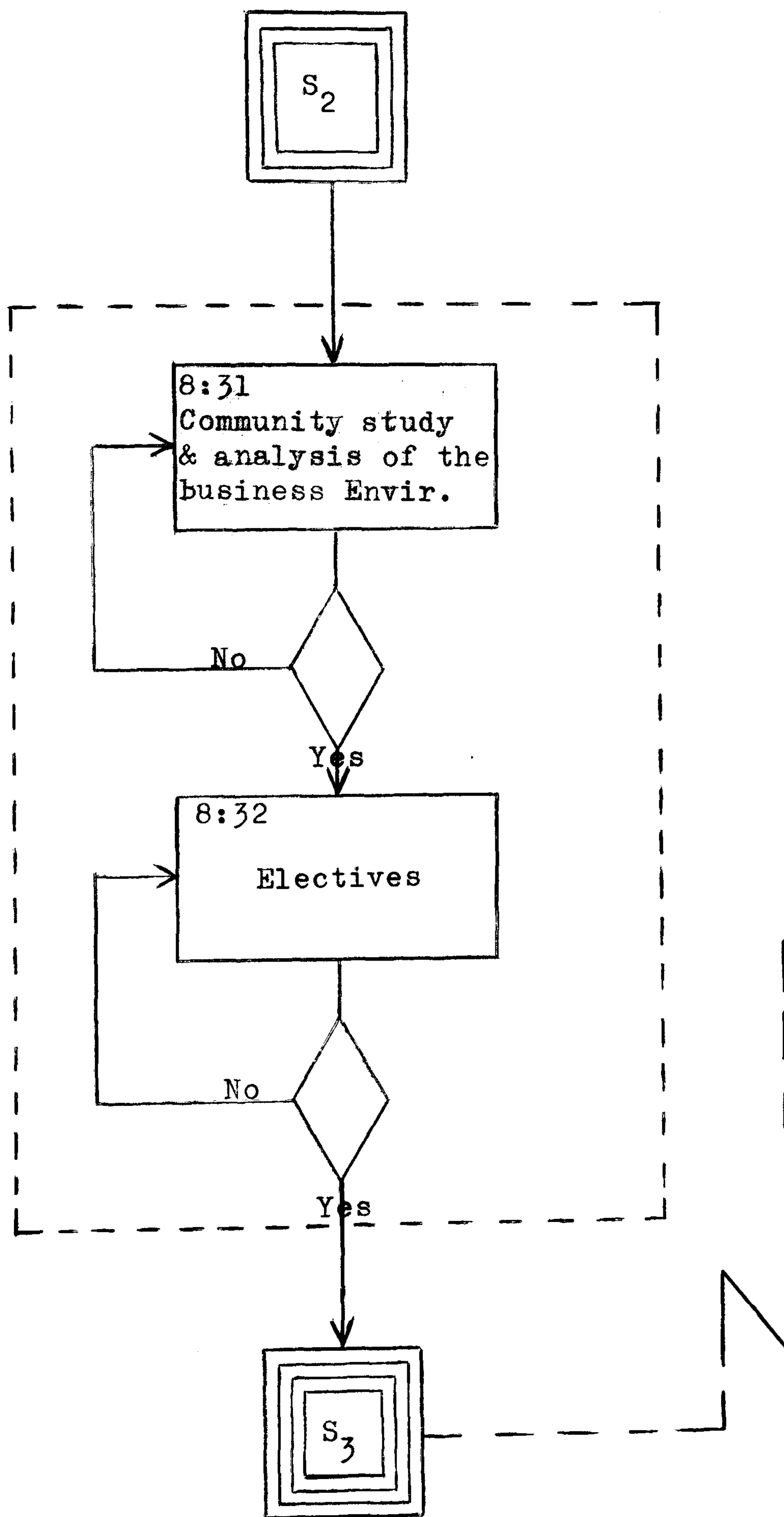

8:31 COMMUNITY STUDY AND ANALYSIS OF
THE BUSINESS ENVIRONMENT

This module provides students with:

- a) an insight into the operations of certain important government departments and institutions.
- b) a way of analysing the business environment as a larger system within which a business enterprise or institution may exist.

This module consists of study visits and observations of the operations of certain government departments and agencies, such as the Department of Trade and Industry; Export Credit Guarantee Department, the Bank of England; the Commodity Market and the Stock Exchange; local government in action.

The analysis of the business environment, product/market situation and import/export trade, and inter-firm comparison.

Individual and group papers supported by an oral presentation at a seminar to be held each week will be regarded as the type of assignment for this module.

Students who have attained a satisfactory standard in this assignment will be awarded one and a half credits.

8:32 ELECTIVES

This module will provide students with a variety of real-world topics, issues, problems of methodology, applications and innovations.

Topics will vary each year according to:

- a) situations which are of public interest and concern;
- b) students demand;
- c) research interests, and
- d) the availability of visiting teachers.

The range of electives to be offered is as follows:

methodology and models; Cybernetics and society;

Cybernetics and Education;

computer applications and Management;

systems design and production efficiency;

information systems; communication models and networks;

Cybernetics and government; problems of growth;

small business problems; innovation in data processing;

balance sheet and accounting issues,

dynamic programming and its applications,

trade union power and its effects on Management,

productive investments analysis; and

others to be approved by the program director and head of SYSTEM TWO.

Each student must prepare a paper, supported by an oral presentation to a seminar.

Students who have attained a satisfactory standard in this assignment will awarded one and a half credits.

FIGURE 8:40 DENOTES AN INTERFACE MODULE BETWEEN THE INSTRUCTIONAL PART AND THE PRACTICAL PART OF THIS PROGRAM.

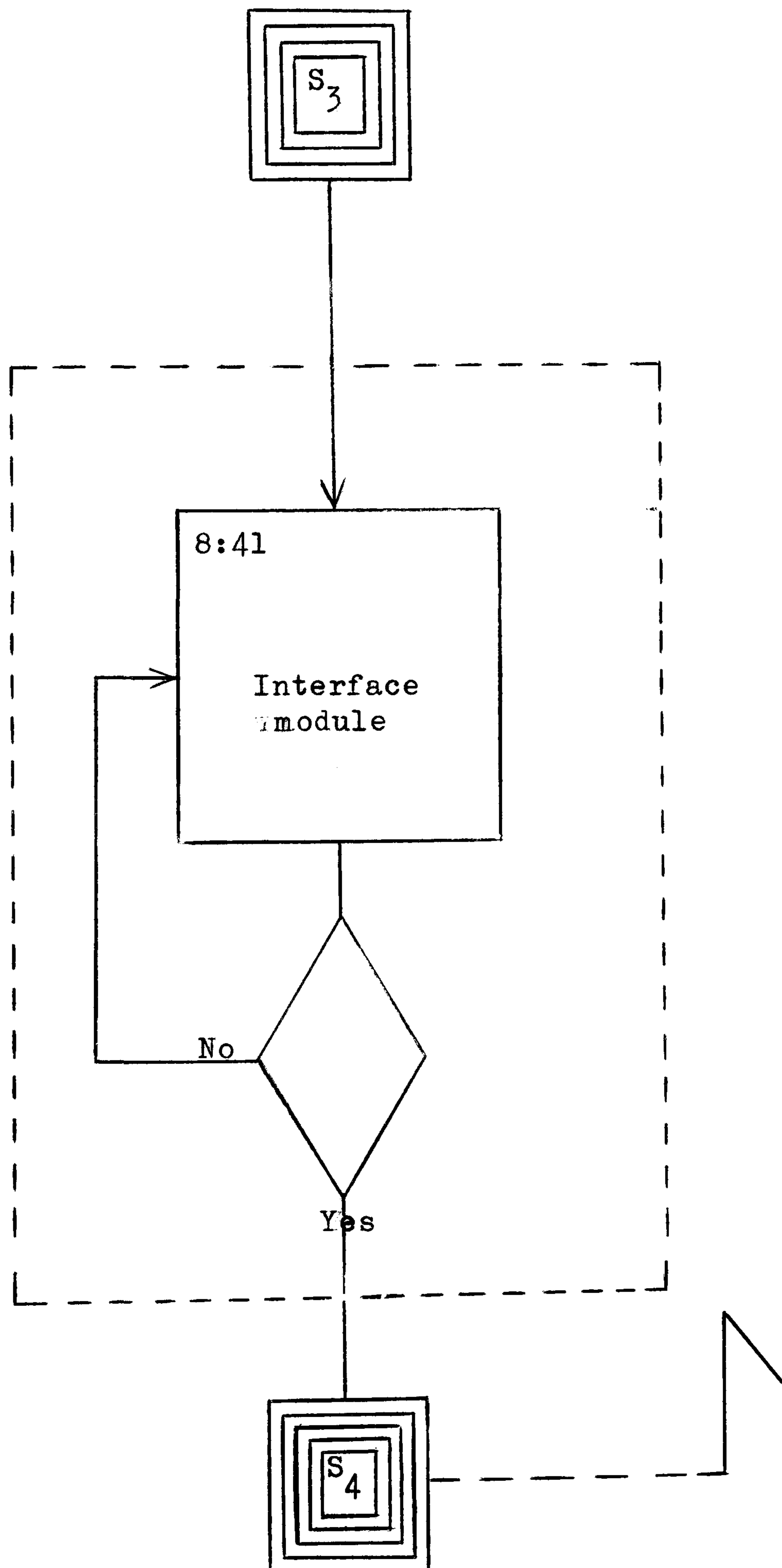

8:41 INTERFACE MODULE

This is a linking module between the instructional part and the practical part of this program. In this module students will carry out an investigation of a case study reflecting real-world managerial problems where they will have on hand a small number of teaching staff for consultation and guidance once a week, at a scheduled period.

The investigation may be carried out in small groups consisting of no more than three students to a group. Each group is required to prepare a written report of their investigation indicating:

- a) their diagnosis;
- b) methodology applied and reasons for its use;
- c) courses of actions, and
- d) their findings.

This module requires a minimum of 20 hours per week study including discussions, consultation and guidance.

The assessment is based on the achievement of a satisfactory standard measured in terms of investigational competence.

Each group of students will also appear before a committee which would include at least one member associated with SYSTEM TWO to discuss their investigation and receive feedback.

Two and a half credits will be awarded for successful completion of this module.

FIGURE 8:50 DENOTES A DIAGRAMMATIC REPRESENTATION OF THE OPERATIONS MODULE WHICH IS CONTROLLED BY SYSTEM TWO.

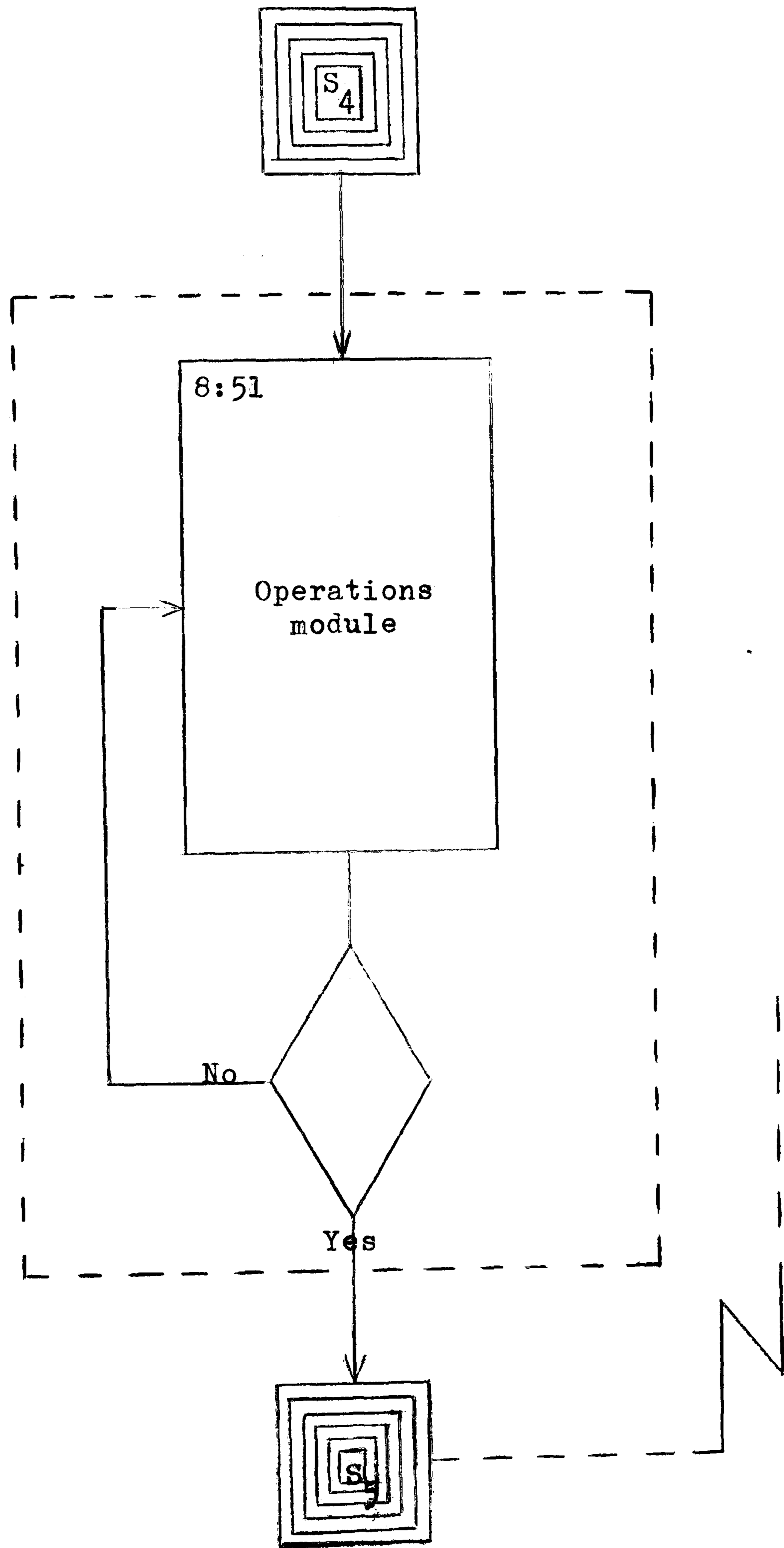

8:51 OPERATIONS MODULE

This operations module, will be controlled by SYSTEM TWO which will install a flexible scheduling procedure so that a student can start his or her practical assignment at a convenient time between July to December. With this flexible scheduling procedure a student does not have to wait for the university teaching calender and schedule before commencing his practical assignment. Also, the fact that sponsors of practical assignments find that their time for providing the necessary environment may not always match with the university teaching calendar.

Each student will spend at least 12 weeks of full-time engagement (not less than 35 hours per week) on a real-world problem, or aspect of a system or a system in a working environment. During this period a student can call for help on a consulting basis or for advice from SYSTEM TWO, which will then assign an adviser to give advice.

At the end of the practical assignment, each student must submit a report to SYSTEM TWO and appear before a panel consisting of one member from SYSTEM TWO, a supervisor and any person or persons whose presence will serve a worthwhile purpose.

The student is allowed an extra week — a minimum of 35 hours to prepare his report.

Each student will spend at least an extra 10 hours as

an internship in SYSTEM TWO where he would be responsible for updating the status of his assignment. The duration spent on this module will be 14 weeks. Assessment would be based on:

- a) a written report prepared by the student,
- b) his or her performance at the place of work in relation to the assignment, and
- c) satisfactory completion of his or her period of internship with SYSTEM TWO.

Successful completion of this module will be awarded 11 credits.

FIGURE 8:60 DENOTES A DIAGRAMMATIC REPRESENTATION OF THE SELF DEVELOPMENT MODULE OF THE PROGRAM.

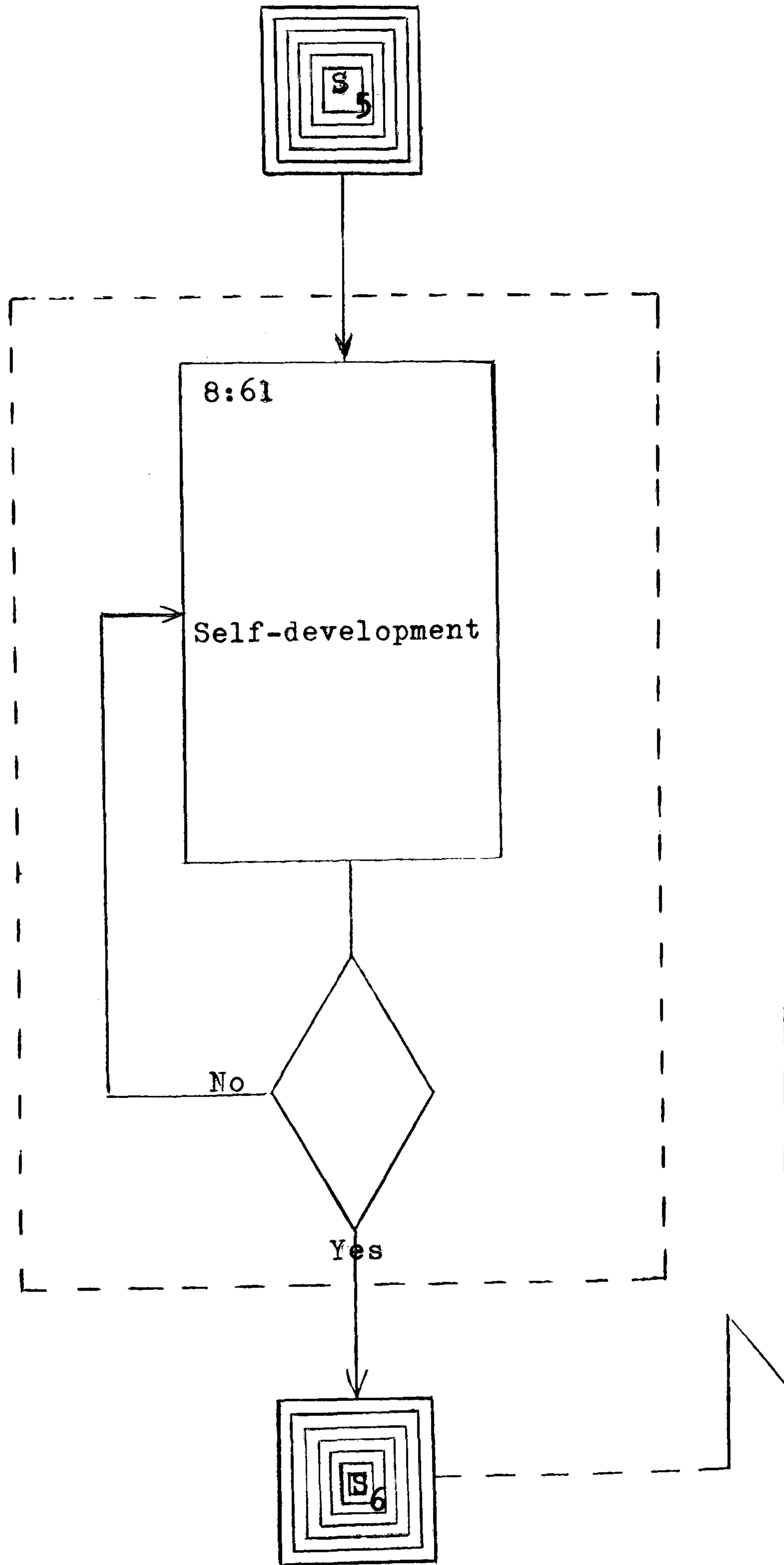

8:61 SELF-DEVELOPMENT MODULE

In this self-development module, each student is required through independence in learning — ability to exercise responsibility for his or her own pace of learning; selection of topic for a dissertation; understand his or her own capacity and develop his or her own style and organisation of thought well beyond his or her vocational abilities — to write dissertation in the areas of Management or Cybernetics and Management.

The topic selected should be approved by a supervisor who will give guidance to the student.

A topic may take the form of a systems design or a critical review supported with counter proposals; or a methodology with respect to its application or a new methodology and pragmatic approach to an aspect of Management or any other of the student's own choice.

This dissertation should not be a reproduction of the work done for the operations module, although the student may make use of the knowledge gained from the entire program. It should not exceed 15,000 words.

A student is expected to demonstrate his or her ability in the organisation and presentation of his or her study and a sufficient mastery of the chosen topic. Success at an oral examination will also be evaluated.

A student will spend at least 14 weeks on his or her study at a minimum of 40 hours per week.

A student whose work having been evaluated as successful would be awarded 13 credits.

SYSTEMS TWO
AND
ITS OPERATIONS

MODULES	DURATION IN WEEKS	TOTAL TIME PER MODULE	CREDITS AWARDED
8:11 Empirical studies and inductive statistics	11	110	2½
8:12 An introduction to the nature of economic and social developments	11	110	2½
8:13 Communication studies	11	110	2½
8:14 Introduction to symbolic logic and scientific thought	11	110	2½
8:21 Information concept and corporate thinking	14	140	3
8:22 Forecasting, planning and scheduling	14	140	3
8:23 Organisation and control	14	140	3
8:24 Legal essentials for Management and the principals of accountancy and the statutory books	14	140	3
8:31 Community study and analysis of the business environment	7	70	1½
8:32 Electives	7	70	1½
8:41 Interface module	7	70	2½
8:51 Operations module	14	460	11
8:61 Self-development	14	560	13
Aggregate	149	2305	51.5
			51.5

Table 8:62 Details of modules and the allocation of time in respect of these modules and credits awarded.

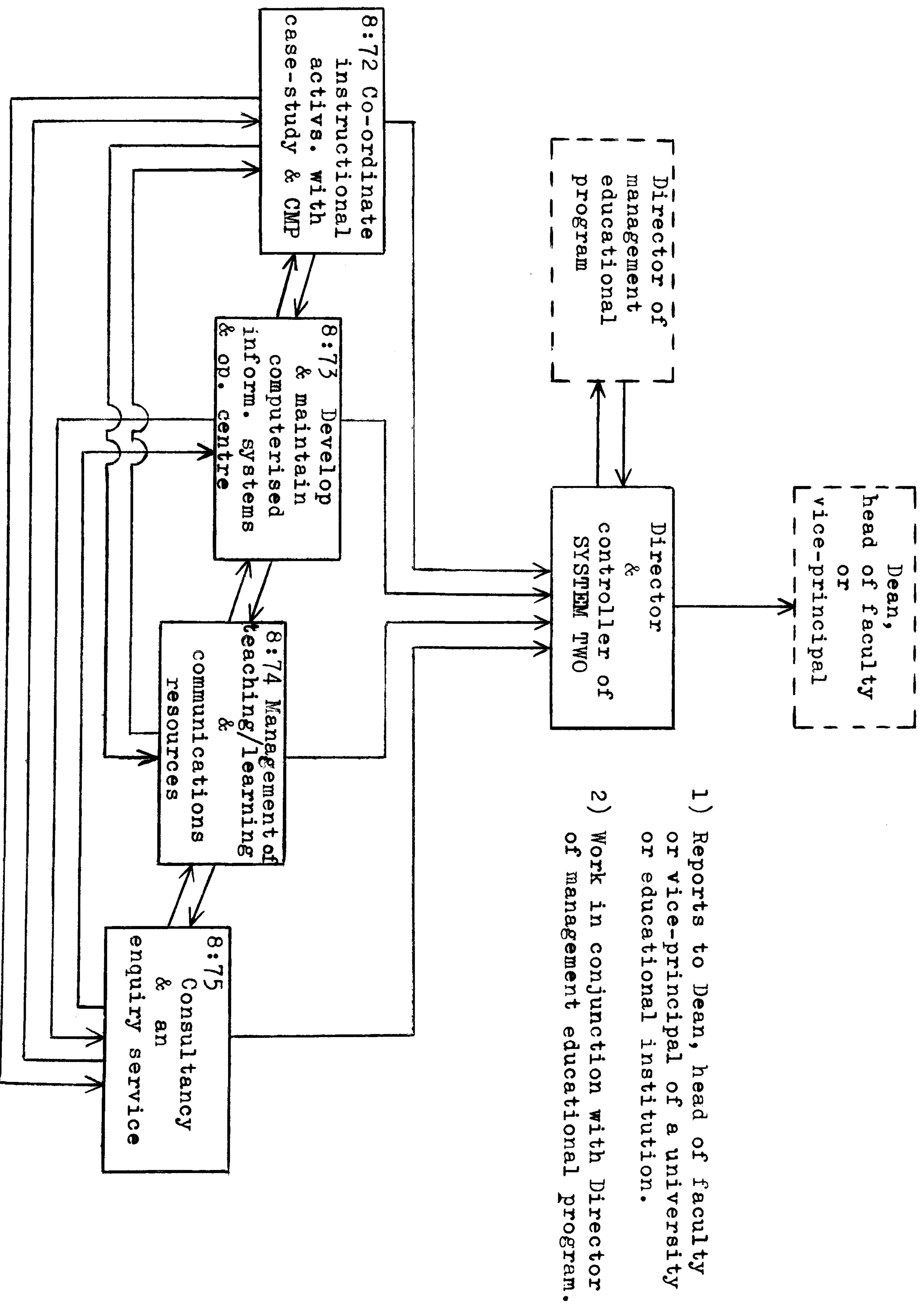

Figure 8/71 denoting an organisational structure of SYSTEM PWO and the relationship of its operations

8:72 CO-ORDINATE INSTRUCTIONAL ACTIVITIES WITH:

- i) CASE STUDY FOR INTERFACE MODULE 8:41 AND
 - ii) CURRENT MANAGERIAL PRACTICES, CYBERNETICS
AND SYSTEMS METHODOLOGIES
-
- a) Provide case-study for interface module and work in close co-operation with instructional staff.
 - b) Make contact within the business environment for, and maintain a schedule of study visits.
 - c) Interview sponsors of the operations module 8:51 and students for assignments, placements, transfers, and being responsible for developing the operations module 8:51 in accordance with the "whole-curriculum's" intention.

SYSTEM TWO will keep a register of all the assignments regarding the operations module 8:51 and their status (completed, in-progress, and assignments available). The names of each student or group of students who is undertaking an assignment will also be on the register.

After a student has completed his assignment he must spend, at least 10 hours with SYSTEM TWO whereupon he must update the status of his assignment and assist in maintaining the register.

8:73 DEVELOP AND MAINTAIN COMPUTERISED INFORMATION
SYSTEMS AND OPERATIONS CENTRE

SYSTEM TWO will develop and maintain an efficient information system supported by a time-sharing technology to enable, at least rapid response, if not both rapid response and rapid up-dating in an interactive mode.

The sources and information content should display previous, current and future Research and Development work in Management, Cybernetics, and other related fields of discipline which may be of interest to our educational program. The information system should also include the name of the person or persons and establishment where the Research and Development have taken place or is taking place, and will take place, if this is available.

From these sources as well as informal sources — information transmitted by word of mouth at Conference meetings, dinners, et cetera — a sustained effort would be made by SYSTEM TWO to establish contacts with those people and establishments involved in Research and Development work which are of interest, or would be of interest to our program.

The operations centre will also produce information bulletins and have a time-table or schedule board displaying program events and special activities of SYSTEM TWO.

The next step would be to establish joint-collaboration with other educational establishments, industrial and other research and development associations including individuals and groups carrying out independent

research which are of interest to our program.

The joint-collaboration may take place in many forms. For example, it may be in the form of sharing information, or actually collaborating in a joint research project with one party working on one aspect or many aspects of a project and the other party working on the other aspect, or both parties working on an entire project. Emanating from this step and subsequent events will be a supply of honorary research associates who can come from a variety of sources:

- a) educational establishments;
- b) research and development associations;
- c) industry;
- d) independent individuals; and
- e) other sources including government research establishments.

Joint collaboration may also attract research funding and introduce economics in the use of other resources.

8:74 MANAGEMENT OF TEACHING/LEARNING,
AND COMMUNICATIONS RESOURCES

- a) To acquire and manage teaching/learning and communications resources including television and sound production, audio-visual arrangement, media resources and computed assisted instructions.
- b) Conduct research relevant to instructional research and development in Management Education.
- c) Offer service and support instructional staff, students and researchers on the program in matters concerning module design, development and evaluation.

SYSTEM TWO will manage with the co-operation of teachers and the director of the management educational program, all teaching and learning resources it acquires. The changing methods of teaching as exemplified in sections 4 and 5 of this thesis require that the acquisition and development of resources which are specifically designed to bring about efficient learning be fully integrated with the purpose of the "whole-curriculum".

A list of educational films related to our program should be maintained and perhaps copies purchased if necessary. The management of these resources will require the co-operation of the teaching staff as well the students with regard to scheduling and their use.

8:75 CONSULTANCY AND AN ENQUIRY SERVICE

SYSTEM TWO will provide a consultancy service to industry, commerce and other institutions for:

- a) Management problems, and
- b) Management Education and Training.

The enquiry service will be a "problem-solving study service".

An enquiry procedure will be established with a view to inviting industry, commerce, banks, private and public enterprises of different sizes, ministries, local government, educational establishments and others to allow our students to help solve their problems.

8:76 FULL TIME PERSONNEL

Director,

Two members of the scale of lecturer to senior lecturer

One research fellow

Secretary - clerical

Research associates

Internships; and

Research students.

9. CONCLUSION

This research concludes that Management is a discipline which is connected to real-life problems, decision making and the organization of a complex entity in a changing environment. A complex entity, such as a business enterprise possesses physiological properties such as manpower, machine, materials, finance and has associated constraints. It has some pre-determined rules which are aimed at co-ordinating the physiological properties of the entity to produce or supply some product and/or service.

Some British Universities and educational institutions are committed to providing Management Education for the intellectual good and analytical ability of their students. The management educational schemes of such a group do not adequately provide the range of experience and imaginative consideration that are required for success in Management.

Contrary to the above group, is another group of British Universities and educational institutions which is committed to providing management educational schemes solely to meet manpower demands. Such a commitment seems practical, and has other advantages over the commitment of the previous group. The likely consequences of the second commitment, are as follows:

- (i) by a commitment to produce students to fit the manpower demands, important teaching activities and resources will have to be tied up to meet this type of demand at the expense of valuable

- educational research and development;
- (ii) that the growth of Management Education will be exposed to very significant errors in Government Manpower Planning which often occur with disastrous effects, i.e retrenchment; closures and sound projects having to be abandoned; and,
 - (iii) that progress in Management Education will be too dependent on the benevolence of certain enterprises whose success are not guarantee owing to economic uncertainties and rapid technological change.

This research offers a way out of the dilemma brought about by the two opposing commitments and therefore recommends:

1. That the objectives of a management educational scheme should be set by people who are primarily concerned with the educational development of students, having regard to the reality of Management and not by representatives of industry and the government; and,
2. That a management educational scheme should have at least two objectives:
 - (a) the initiation of students into a body of knowledge and experience made public which can be used as a point of reference to future managers, and

- (b) to provide certain essential forms of knowledge which are intended to enable students to develop beyond their vocational abilities and adapt to changing conditions not withstanding at least, an acceptable standard of competency in Management.

The way out suggests an educational direction with a professional outlook.

An educational scheme requires supportive teaching and resource system in order to achieve measureable goals. The objectives of the scheme should be correctly translated by the teachers followed by the appropriate teaching methods. These diagnoses are best effected by a cybernetic framework followed by coherent actions.

The teaching/learning framework developed in this work is based on cybernetic concepts and principles. Effecting certain corrective actions would involve negotiation through the stages of implementation. In this respect, the researcher recommends:

1. That in the negotiation, a plan should be formulated to encourage teachers to:
 - (a) attend study sessions in the mechanisms of control and communication as a content of, Management and in the science of teaching, and
 - (b) have study leave to return to industry, commerce or with a consulting enterprise which has a reputation for exploring and finding solutions to real-world problems.

2. That the promotion and merit rating structures for teachers in Management Education be altered to give those teachers who have practical experience in:

- (a) managerial problem solving,
- (b) organization control in a dynamic enterprise,
- (c) those who have undergone 1(a) and 1(b) above, and
- (d) those teachers who pay more attention to pedagogy, the science of teaching than to academic research.

The present promotion and merit rating structures in many universities and educational institutions are weighted too much in favour of academic research; a quantum of publications, and membership of committees. Such structures lead to lack of attention to pedagogy.

The curriculum design presented in section 8 of this thesis contains the basic forms of knowledge and arrangements for a worthwhile management educational scheme in accordance with the educational direction described earlier in the research.

SYSTEM TWO presents a framework for a supportive system which implements the objectives of the scheme. This framework has more to offer than the present arrangement of committees as a means for effecting an administrative network over the operations of an educational scheme.

A committee does not have a regular channel of communication. For it meets periodically (sometimes irregular) depending on having a quorum and/or enough topics for an agenda. It ceases to transmit as an organized body when the meeting ends, thus allowing a high proportion of noise, filtration and intermediaries to enter the channel of communication. Hence a higher proportion of noise to administrative messages — a condition for poor communication.

This research has a positive value in that it demonstrates that Cybernetics far from being a set of abstract and theoretical ideas, has a body of concepts and principles which are worthwhile and needed to improve:

1. The state of Management;
2. Management Education; and
3. The science of teaching.

APPENDIX 1

18, Adys Road,
Peckham,
London. S.E.15

10th September, 1974

The Head,
School of Business and Management Studies,
.....
.....
.....

Dear Sir,

I would like to obtain the following information on your master's degree scheme in Management by instructions, and have designed a simple questionnaire hereunder for your reply.

1. What is the exact title of the scheme and what faculty does it come under?
.....
2. What is the content of the scheme?
.....
3. What are the aims or objectives of the scheme?
.....
4. What are the teaching methods used in relation to your scheme, and which is the most widely used method and for what topics?
.....
5. What are the methods of assessment for students on the scheme?
.....

Thank you for an early reply.

Yours sincerely,

.....
K.V. Lorimer

APPENDIX 11

List of British business schools and departments of Management Studies from which replies were received.

Aston
Bath
Belfast (Queens)
Birmingham
Bradford
Bristol
Brunel University (Henley)
Cardiff
Central London Polytechnic
City Polytechnic
City
Cranfield
Durham
Essex
Heriot-Watt
Hull
Imperial College
Kent
Lancaster
Leeds
Liverpool
London (LBS)
London School of Economics
Loughborough
Manchester (MBS)
Oxford
Reading
Salford
Scottish: Edinburgh
 Glasgow
 Strathclyde
Sheffield
Sheffield Polytechnic
Southampton

South Wales

Stirling

Thames Polytechnic

The University of Manchester Institute of Science and Technology
(UMIST)

The University of Wales Institute of Science and Technology
(UWIST)

Warwick

REFERENCES

- AIR MINISTRY.(1963). "Orgins and Development of Operational Research in the Royal Air Force". H.M.S.O.
- ALLPORT, G.W.(1937). "Personality: A Psychological Interpretation". Henry Holt, New York.
- ASHBY, R.W.(1960). "Design for a Brain". Chapman and Hall, London.
- BEER, S.(1970). "The Organization of the Manchester Business School from Nineteen-Seventy". Manchester Business School.
- BEER, S.(1956). "Operational Research and Cybernetics". Proceedings of the First International Conference on Cybernetics. Namur.
- BEER, S.(1959). "Cybernetics and Management". English University Press.
- BEER, S.(1975). "Platform for Change". John Wiley & Sons.
- BEER, S.(1972). "Brain of the Firm". Allen Lane. The Penguin Press. pp.306.
- BELLMAN, R.(1957). "Dynamic Programming". Princeton University Press.
- BLACKETT, P.M.S.(1962). "Studies of War". Oliver and Boyd.
- BRECH, E.F.L.(1963). Management in Principle in "The Principles and Practice of Management". Longmans. pp.3-94.
- BRITISH INSTITUTE OF MANAGEMENT.(1974). "Code of Best Practice". British Institute of Management pp.1-9.
- BROWN, J.A.C.(1954). "The Social Psychology of Industry". Penguin Books.
- BRUNER, J.S.(1964). The Course of Cognitive Growth. American Psychologist. Vol.19 pp.1-15, January.
- BUSIGNIES, H.(1971). Trends and Future of Telecommunications. Signal. Vol.28 No3, pp.16-19, November.
- CANNON, W.R.(1939). "The Wisdom of the Body". W.W.Norton & Co Inc.
- CHOMSKY, N.(1957). "Syntatic Structures". Mouton.
- CHURCHMAN, C.W., ACKOFF, R.L. and ARNOFF, L.(1957). "Introduction to Operations Research". J.Wiley & Sons, New York.
- CLARK, D.G.(1960). "The Industrial Manager. His background and Career Pattern". Business Publications Limited. London.
- CLARKSON, G.P.E.(1962). "Portfolio Selection. A Simulation of Trust Investment". Prentice-Hall, U.S.A.

COMMITTEE ON HIGHER EDUCATION.(1963). "Higher Education"
report under the chairmanship of Lord Robins 1961-63. H.M.S.O.

COMPANIES ACT.(1856). H.M.S.O..

COMPANIES ACT.(1948). H.M.S.O.

COMPANIES ACT.(1967). H.M.S.O.

"THE COMPANIES (UNREGISTERED COMPANIES) REGULATIONS 1967
(SI 1967 No 1876)". H.M.S.O.

"THE COMPANIES (DISCLOSURE OF DIRECTORS' INTERESTS) (EXCEPTION)
No3 REGULATION 1968 (SI 1968 No 1533)". H.M.S.O.

COPLEY, F.B.(1928). "Frederick Winslow Taylor: Father of
Scientific Management". Harper and Row, New York.

DE GROOT, A.(1968). Thought and Choice in Chess in "Thinking and
Reasoning". Wason, P.C. and Johnson-Laird, P.N., Eds. Penguin.

DEUTSCH, K.W.(1952). On Communication Models in the Social
Sciences. Public Opinion Quarterly. Vol.16 pp.356-380.

DEVLIN, Hon. Sir Patrick.(1959). "The Enforcement of Morals".
Maccabean Lecture in Jurisprudence of the British Academy.
Oxford University Press. London.

THE EDUCATION ACT.(1918). H.M.S.O.

THE EDUCATION ACT.(1944). H.M.S.O.

FEDERATION OF BRITISH INDUSTRIES' REPORT ON MANAGEMENT EDUCATION
AND TRAINING NEEDS OF INDUSTRY (1963) June.

FOLLET, M.P.(1941). "Dynamic Administration". Pitman.

FRANKS, Baron, O.S.(1963). "British Business Schools". British
Institute of Management.

GILBRETH, F.B.(1911). "Motion Study". Van Nostrand, New York.

GILBRETH, F.B. Jr. and CAREY, E.G.(1949). "Cheaper by the Dozen".
Heinemann.

GEORGE, F.H.(1973). "Pragmatics". Unpublished work, Brunel
University.

GEORGE, F.H.(1961). "The Brain as a Computer". Pergamon Press.

LORIMER, K.V.(1976). "The Problem of Judging Methodology", per se
"Good" or "Bad". Organic Problem Solving in Management,
Symposium - N. European Meeting on Cybernetics and Systems
Research. Vienna, Austria.

MAYO, E.(1933). "Human Problems of an Industrial Civilization".
Routledge and Kegan Paul.

MINISTRY OF LABOUR.(1964). "Industrial Training Act", 1964.
H.M.S.O.

NEWELL, A., SHAW, J.C. and SIMON, H.(1958). Elements of a Theory of Human Problem Solving. Psychological Review. Vol.65 pp.151-166
March.

NEWELL, A. and SIMON, H.(1972). "Human Solving". Prentice-Hall,
U.S.A.

PASK, G. and SCOTT, B.C.E.(1973). CASTE: A System for Exhibiting Learning Strategies and Regulating Uncertainties. Journal of Man-Machine Studies. Vol.5 pp.17-52.

"REGULATIONS UNDER RULE 224 OF THE COMPANIES (WINDING-UP) RULES 1949. (Issued 7th May, 1965)". H.M.S.O.

ROSENBLUETH, A., WIENER, N. and BIGELOW, J.(1943). Behaviour, Purpose and Teleology. Philosophy of Science. Baltimore. pp.18-24,
January.

SHANNON, C. and WEAVER, W.(1949). "The Mathematical Theory of Communication". University of Illinois Press, Urbana, Chicago.

SIMON, H.A.(1957). "Administrative Behaviour". Macmillan.

STORR, C.(1949). "Henri Fayol, General and Industrial Management". Pitman.

TAYLOR, F.W.(1947). "The Principles of Scientific Management". Harper and Row.

UNIVERSITY OF LONDON (1975). "Regulations for First Degrees in the Faculty of Education B.Ed., B.H. for Internal Students including General Regulations". University of London. 102 pages.

UNIVERSITY OF LONDON.(1976). "Changes in Regulation for Internal Students". Amendment slip No6 May,1976. 42 pages.

URWICK, L.(1947). "The Elements of Administration". Pitman.

WALTER, W.G.(1953). "The Living Brain". Duckworth, London.

WHEATCROFT, M.(1970). "The Revolution in British Management Education". Pitman Publishing. pp.3.

WIENER, N.(1961). "Cybernetics or Control and Communication in the Animal and the Machine". Cambridge, Massachusetts.

WILENSKY, H.(1957). "Human Relations in the Workplace: An Appraisal of Some Recent Research, in Industrial Human Relations". Harper and Row, New York.