

Decentralized TSO-DSO coordination for voltage regulation purposes based on renewable energy sources management – Sensitivity and robustness analyses

Mohammed Radi^{a,*}, Nermin Suljanovic^b, Miloš Maksič^b, Gareth Taylor^c, Ioana Pisica^c, Andrej Souvent^d

^a Enterprise Data Management, UK Power Networks, Newington House, London, United Kingdom

^b Elektroinštitut Milan Vidmar - Electric Power Research Institute, Hajdrihova 2, 1000 Ljubljana, Slovenia

^c Department of Electronic and Computer Engineering, Brunel University, Kingstone lane, Uxbridge, United Kingdom

^d Operato, Barvarska ulica 7, 2000 Maribor, Slovenia

ARTICLE INFO

Keywords:

Renewable integration
Transmission system operator (TSO)-
Distribution system operator (DSO)
coordination
Voltage control
Reactive power management
Business use case (BUC) standardization

ABSTRACT

The increasing penetration of Renewable Energy Sources (RES) in distribution networks has led traditional voltage regulation to their boundaries. In order to develop advanced techniques for voltage control in this new context, an adequate and real-time coordination and communication between Transmission System Operators (TSOs) and Distribution System Operators (DSOs) is needed. In this paper, a decentralized TSO-DSO coordination approach for scheduling and deploying optimal reactive power exchanges in the DSO's boundary for improved voltage control in the TSO's networks is proposed. The proposed approach is implemented via a standardized Business Use Case (BUC). The interoperability between the TSO, the DSO, and other stakeholders is solved by designing and developing the BUC within the framework of the International Electrotechnical Commission (IEC) Common Information Model (CIM) family of standards IEC61970, IEC61968, and IEC62325. In view of the lack of pilot tests in the field, the proposed standardized BUC is demonstrated on real-world Slovenian TSO's and DSO's networks. The simulation experiments presented in this paper are twofold. On one hand, the proposed data exchange mechanism based on the standardized BUC demonstrates the feasibility of successfully exchanging data between the TSO, the DSO, and other stakeholders, such as the Significant Grid Users (SGUs) and Meter Operators, as a CIM Common Grid Model Exchange Standard (CGMES) format. On the other hand, the capability of the proposed decentralized TSO-DSO coordination approach to regulate the High Voltage (HV) by managing the reactive power injected by different RES, such as capacitor banks and different Distributed Generators (DGs), viz. hydropower, Photovoltaic (PV), and thermal (co-generation) units, is validated via sensitivity and robustness analyses for different network topologies, DGs' operating scenarios, and capacitor banks' sizes and locations. The simulation results show that the proposed approach can manage DGs toward contributing additional (positive or negative) reactive power to reduce the voltage deviations in the grid, improve the power quality at the DSO's boundary by reducing the flow of reactive power from the TSO's to the DSO's networks and vice versa, and keep the HV voltage within safe values. Unfortunately, this is not the case for the capacitor banks, where the capability of the proposed approach to manage their injected reactive power to regulate the HV voltage is highly dependent on their sizes and location, being necessary to be studied on a case-by-case basis.

1. Introduction

Voltage control in smart grids is crucial toward ensuring the proper operation of electrical power equipment reducing transmission losses and increasing the system's reliability [1–4]. Traditionally, On Load Tap

Changer (OLTC), Switched capacitors (SC), and Step Voltage Regulators (SVR) have been used for voltage regulation purposes [5]. Nevertheless, the integration of Renewable Energy Sources (RES) to electricity distribution networks has led these methods to their boundaries. In particular, the voltage variation of Distributed Generators (DGs) is so

* Corresponding author.

E-mail address: Mohammed.Radi@UKpowernetworks.co.uk (M. Radi).

<https://doi.org/10.1016/j.epsr.2022.108674>

Received 26 January 2022; Received in revised form 4 July 2022; Accepted 23 July 2022

Available online 30 July 2022

0378-7796/© 2022 The Authors. Published by Elsevier B.V. This is an open access article under the CC BY license (<http://creativecommons.org/licenses/by/4.0/>).

rapid that traditional devices cannot take the correction action at that pace, causing unpredictable voltage rises in the grid [6]. Several approaches have been proposed in the literature to regulate voltage in this new scenario [4–8], being the ones based on reactive power management among the most popular ones because of their scalability, efficiency, flexibility, and reliability [9].

Different topologies, viz. local, global, and decentralized ones, can be used to perform reactive power management for voltage purposes [6]. In the local architecture, decisions are based only on local data, ignoring the state of the system, avoiding the need for a complex communication system. Although being simple, the local architecture usually lacks accurate results. The global architecture, on its part, can achieve better results than the local one at the expense of an extensive communication system. The decentralized architecture intends to overcome the technical issues of the local and global ones. In this approach, each system operator, namely the Transmission System Operator (TSO) and the Distribution System Operator (DSO), is responsible for integrating the RES in its own network, while collaborating in a more common market [10,11]. In this way, more efficient facilitation of RES services is allowed, while having fewer communication requirements. Unfortunately, although promising results exist, the industry still exhibits innate inertia to invest in innovative solutions, such as the decentralized one, that has a different philosophy. In this line, researchers agree that there is a great need for more pilot sites and largescale tests in this area [8].

In this paper, a decentralized control approach for scheduling and deploying optimal reactive power exchanges in primary substations for improved voltage control in the TSO's networks is proposed. In order to do so, it is crucial to ensure adequate and real-time coordination and communication between the TSO and the DSO. On one hand, the TSO should be provided with updated information about the distribution grid state, whereas the DSO needs information to predict such state and make operational plans toward achieving an effective voltage regulation on both sides [12–20]. On the other hand, the amount and type of the needed information to be exchanged should also be determined to avoid impacting the DSO's voltage level when the TSO performs reactive power management actions. In this scenario, several interoperability challenges arise, being crucial to provide a TSO-DSO coordination framework capable of understanding the content and the structure of the data that is necessary to be exchanged to regulate the TSO's voltage via the RES management at the DSO's boundary [21–23].

In order to solve the interoperability issues between the TSO, the DSO, and other stakeholders, a Common Information Model (CIM) based approach is proposed in this paper. CIM is a widely accepted concept for interoperability and integration in modern power systems, allowing to support object-oriented programming concepts and represent power system components, toward addressing infrastructure, management, and operation issues [22,24]. In particular, a Business Use Case (BUC) approach based on the Smart Grid Architecture Model (SGAM) concept [15] is used to implement the decentralized TSO-DSO coordination approach. The proposed standardized BUC is designed based on the categorization of International Electrotechnical Commission (IEC) SyC Smart Energy 62,559–2 Edition 1 [25] and developed within the framework of the IEC CIM family of standards IEC61970, IEC61968, and IEC62325 [22,24].

Researchers in the field agree that there is a lack of pilot and benchmark tests in the area of TSO-DSO coordination [26]. In order to bridge this gap, the proposed BUC is demonstrated on a real-world Slovenian network model. The demonstration presented in this paper is twofold. On one hand, data is exchanged as a CIM Common Grid Model Exchange Standard (CGMES) format between two real Slovenian TSO's and DSO's networks to validate the proposed data exchange mechanism based on the BUC. On the other hand, the capability of the proposed decentralized TSO-DSO coordination approach implemented via the standardized BUC to manage the reactive power injected by the RES distributed within the boundaries of the DSO for regulating the voltage at the TSO's side is evaluated. In particular, sensitivity and

robustness analyses are conducted by testing the proposed approach within the context of different reactive power injection scenarios, including capacitor banks and different types of DGs, such as hydro-power, Photovoltaics (PV), and thermal (co-generation) units, for different network topologies, DGs' operating scenarios, and capacitor banks' sizes and locations. The simulation results on a TSO and DSO of the Slovenian Gorenjska region show that the proposed data format based on the CIM CGMES standards allows to exchange data successfully between the TSO, the DSO, and other stakeholders, such as the Significant Grid Users (SGUs) and Meter Operators, enabling reactive power management at the DSO's boundary for the sake of voltage regulation at the TSO's level. In particular, within the proposed TSO-DSO coordination framework, it has been demonstrated that DGs can be managed toward contributing additional (positive or negative) reactive power to reduce the voltage deviations in the grid, improve the power quality at the DSO's boundary by reducing the flow of reactive power from the TSO's to the DSO's networks and vice versa, and keep the High Voltage (HV) within safe values. Unfortunately, this is not the case for the capacitor banks, where the capability of the proposed approach to manage their injected reactive power to regulate the HV voltage is highly dependent on their sizes and location, being necessary to be studied on a case-by-case basis.

2. State of the art

The increasing amount of DG units connected to the distribution networks has brought new challenges in terms of voltage control, leading traditional methods to their limits [6,8]. Authors in [27] have shown that, within the context of a high RES penetration, voltage rise is dependent on two main factors, namely voltage unbalance and reverse Power Flow (PF). In this way, compensating one or another should support voltage regulation. In [27], the voltage unbalance is canceled by negative-sequence current injection to reduce the maximum line-to-line voltage. Results in [27] confirm that the proposed strategy, which prioritizes the voltage unbalance compensation, can solve the voltage rise problem while improving the power quality by balancing the Point of Common Coupling (PCC) voltage. In [28], an Energy Storage Unit (ESU) is proposed to reduce voltage unbalance. Results in [28] show that the ESU acts as an energy conditioning device to absorb excess power from the network that is integrated by the RES while being capable of delivering power to the network when there is an increase in demand.

In general, the approaches based on mitigating voltage unbalance rather than managing reactive power to regulate voltage tend to be complex and they often need to be coupled with other control techniques to achieve good results [6]. In [29], both techniques, namely voltage unbalance mitigation as well as reactive power management, are combined in a novel voltage control strategy. In particular, voltage is regulated by increasing the Positive Sequence (PS) voltage and decreasing the Negative Sequence (NS) voltage as well as injecting a certain amount of reactive power to restore the PCC voltage. Results in [29] show that the proposed approach allows supporting the grid voltage, preventing overvoltage in the DC-link and inverter overcurrent. In [6], different reactive power control topologies have been used for voltage regulation in a grid-connected PV system. Results in [6] suggest that, although during peak hours real power generation and voltage rise at PCC are maximum, the ability of inverters to provide the required reactive power is diminished due to the apparent power capability of the inverter. In this context, a cost-effective and simple solution is to add other sources of reactive power along with PV inverters during peak times. In [30], a trust-region framework for coordinating the reactive power output of wind generators and other reactive controllers for voltage regulation is proposed. Results in [30] show that proper coordination of reactive power improves the loadability margin, avoiding the need to operate the wind generators at their maximum reactive limits for voltage stability purposes.

The need for coordinating TSO and DSO for voltage control in smart

grids has largely been recognized in the literature [6]. In [31], a TSO-DSO coordination approach within a service-oriented flexibility market is proposed for voltage regulation at the edge of the transmission system. Results of the Greek case study conducted in [31] show that the proposed TSO-DSO coordination can create financially viable solutions for TSO to leverage flexibility from distribution grids in order to alleviate over-voltages caused by Ferranti. In [32], a novel market-based TSO-DSO coordination scheme, compatible with existing TSO's balancing market operation, is proposed for voltage regulation during peak demand periods. In particular, although in [32] the DSO is given priority in using Distributed Energy Resources (DERs) to solve distribution network constraints, there is still significant flexibility for the TSO even during periods of peak demand and maximum export. Results of the case studies conducted in [32], demonstrated on a section of a Great Britain distribution network using high DER growth scenario data for the year 2030, show that the proposed approach is able to maintain thermal and voltage limits during periods of peak demand and DER output.

Despite the recent advances in Information and Communication Technology (ICT), the envision and design of decentralized TSO-DSO coordination infrastructures for large-scale implementation to regulate the voltage at the TSO's level based on managing reactive power in distribution networks is still challenging. In the last years, some works using BUC methodology and ICT to address the TSO-DSO coordination have been proposed in the literature [33–35]. In [33], ICT techniques are used to facilitate interoperable, scalable, and secure data exchange between the TSO and the DSO. In particular, BUCs and System Use Cases (SUCs) defining different communication scenarios between the TSO, the DSO, and other market participants, such as SGUs and RES, are evaluated. Results in [33] show that the proposed ICT-based approach has the potential to provide greater access and support regarding cross-border trading and real-time balancing. In [34], a BUC methodology is proposed to implement an interoperable communication architecture supporting TSO-DSO information exchange. In particular, the proposed BUC-based approach is utilized for identifying information exchange requirements, which are materialized through Business Objects gap analysis against existing standardized IEC CIM profiles. In [35], a cloud-based approach is proposed to coordinate the bidirectional communication between the TSO and the DSO regarding market-related information and data infrastructures. In particular, different access levels are demonstrated in [35] resorting to the definition of BUCs for a trusted cloud platform by considering harmonized access processes and role-based access control for security. Results in [35] show that the proposed bidirectional communication approach can help to overcome the technical and logistic challenges appearing when dealing with different stakeholders starting from the generation side and reaching the consumption side.

In this paper, a decentralized TSO-DSO coordination approach for scheduling and deploying optimal reactive power exchanges in the DSO's boundary for improved voltage control in the TSO's networks is proposed. The challenging interoperability issues between the TSO, the DSO, and other stakeholders, are addressed by implementing a standardized BUC based on the categorization of IEC SyC Smart Energy 62559–2 Edition 1 and developed within the framework of the IEC CIM family of standards IEC61970, IEC61968, and IEC62325. In order to contribute to the state of the art by providing pilot tests in the area, the standardized BUC is demonstrated on a real-world Slovenian network model. The experimental simulations conducted in this paper are twofold. On one hand, data is exchanged as a CIM CGMES format between two real Slovenian TSO's and DSO's networks to validate the proposed data exchange mechanism based on the BUC. On the other hand, the capability of the proposed decentralized TSO-DSO coordination approach implemented via the standardized BUC to manage the reactive power injected by the RES distributed within the boundaries of the DSO for regulating the voltage at the TSO's side is evaluated. In particular, sensitivity and robustness analyses are conducted by testing

the proposed approach within the context of different reactive power injection scenarios, including capacitor banks and different types of DGs, such as hydropower, PV, and thermal (co-generation) units, for different network topologies, DGs' operating scenarios, and capacitor banks' sizes and locations.

3. Scope and methodology

This paper is based on the scope of the TDX-ASSIST¹ project that aims to design and develop novel ICT tools and techniques that facilitate scalable and secure data exchange between TSOs and DSOs. The main objective of this paper is to propose and evaluate a decentralized TSO-DSO coordination mechanism for scheduling and deploying optimal reactive power exchanges in primary substations for improved voltage control in the TSO's networks. In this line, it is crucial to determine the needed information to be exchanged between the TSO and the DSO toward avoiding impacting the DSO's voltage level when the TSO performs reactive power management actions. In order to do so, the existing resources at the DSO capable of supporting the TSO operations are considered. On one hand, the TSO and DSO should coordinate the reactive power at each primary substation at different time frames, such as several hours or days ahead, in operational planning. On the other hand, the DSO should try to meet the set point using its flexibility assets, such as capacitor banks, inductances, and storage, as well as defining the reactive power that can be injected/absorbed by the DGs connected in the Medium Voltage (MV) network at real-time.

In this paper, a standardized BUC methodology is used to implement the proposed decentralized TSO-DSO coordination scheme. The data exchange between the TSO, the DSO, and other stakeholders is based on the concept of CIM which allows integrating IT systems by means of common service-oriented architecture. To actually implement such model and ensure proper interoperability between the TSO, the DSO, and the stakeholders, the IEC CIM family of standards IEC61970, IEC61968, and IEC62325 is adopted [22–24]. The proposed approach is then evaluated within a real-world Slovenian scenario via the standardized BUC designed based on the IEC SyC Smart Energy 62,559–2, which is a canonical and well-structured Use Case Methodology tightly related to SGAM applications. In particular, the BUC is created using an extension of the Enterprise Architect (EA) called MODSARUS® (EDF R&D tool) [36], which allows bringing to EA a model-driven approach to specify unambiguous, interoperable, and vendor-independent smart grids and energy systems. In this way, a well-structured and standardized methodology, widely used in the field [15,22–25,37–40], based on standard methods and tools, such as IEC SyC Smart Energy 62559–2a Use Case Methodology, Unified Modelling Language (UML), and EA, is used to validate the proposed data modeling and exchange approach.

The performance of the proposed approach is evaluated through different demonstrations conducted on real TSO's and DSO's models provided by the Slovenian system's operators Elektro-Slovenija (ELES)² and Elektro Gorenjska (EG)³, respectively. The experimental simulations conducted are twofold. On one hand, data is exchanged as a CIM CGMES format to validate the proposed data exchange mechanism based on the BUC. On the other hand, the capability of the proposed decentralized TSO-DSO coordination approach implemented via the standardized BUC to manage the reactive power injected by the RES distributed within the boundaries of the DSO for regulating the voltage at the TSO's side is evaluated. In particular, sensitivity and robustness analyses are conducted by testing the proposed approach within the context of different reactive power injection scenarios, including capacitor banks and different types of DGs, such as hydropower, PV, and thermal (co-generation) units, for different network topologies, DGs'

¹ <http://www.tdx-assist.eu/>

² <https://www.eles.si/en/>

³ <https://www.elektro-gorenjska.si/>

operating scenarios, and capacitor banks' sizes and locations.

4. Standardized BUC definition

Fig. 1 shows an overview of the proposed standardized BUC. The business actors of the BUC are the DSO, the TSO, the SGU, and the Meter Operator. In order to implement the BUC, allowing the DSO to interact with the TSO (and vice versa) for supporting the voltage at its side, the following technical pre-requisites should be fulfilled:

- If the TSO sends a P/Q diagram to the DSO (where P and Q stand for active and reactive power, respectively), the TSO should know the contracted power with the DSO.
- In the TSO-DSO-Meter Operator coordination platform, the following technical issues should be considered:
- Grid monitoring is needed for the DSO's and TSO's areas. This monitoring can be provided and installed by a third party such as a Meter Operator.
- All the interactions modes require a mutual common platform between the DSO, the TSO, and the Meter Operator for the purpose of data exchange, regarding the voltage measurements and the existing voltage control tools.
- If the DSO disposes the capacitor banks, it should know their operational state.
- SGUs must be equipped with remote terminal units to send their measurements to the DSO and to receive the Q set points.
- The DSO should know the characteristic P/Q of the SGU.

The performance of the proposed standardized BUC for the decentralized TSO-DSO coordination is evaluated in terms of the following Key Performance Indicators (KPIs):

- Track of HV voltage deviation: This KPI measures the average and maximum HV voltage deviation.

- Track of the RES and DER hosting capacity: This KPI evaluates the voltage quantity that can be connected to the distribution network.

Finally, it is a well-known fact that several legal aspects should be considered in order to allow the DSO to manage reactive power injection within the framework of RES penetration. Nevertheless, this paper is mainly focused on the technical aspects of the BUC implementation, being the legal discussion out of its scope.

5. Standardized BUC design

The proposed standardized BUC addresses the coordination mechanism between the TSO and the DSO focusing on reactive power management for voltage control purposes. In particular, the TSO-DSO collaboration takes place to support the voltage level on the distribution network by the TSO, and on the transmission network by the DSO. On one hand, the proposed collaborative approach is based on the fact that the energy resources in the DSO can contribute to optimizing the reactive power in the TSO's network. This requires representing the different SGUs in the DSO's network within the operational planning strategy. On the other hand, the TSO can guarantee voltage set points demanded by the DSO to avoid or reduce the voltage constraints in the network managed by the DSO. The BUC is then designed taking into account the following key aspects:

- Reactive power flexibility assessment in the DSO's and TSO's networks.
- Coordination between the DSO and the TSO in terms of the constraints management for the reactive power and voltage control.
- Optimal control of voltage and reactive power sources in power systems with the presence of DER.
- Exact required information and operational requirements are exchanged between the stockholders in a timely manner in order to be able to optimally manage the reactive power and voltage control in different parts of the grid.

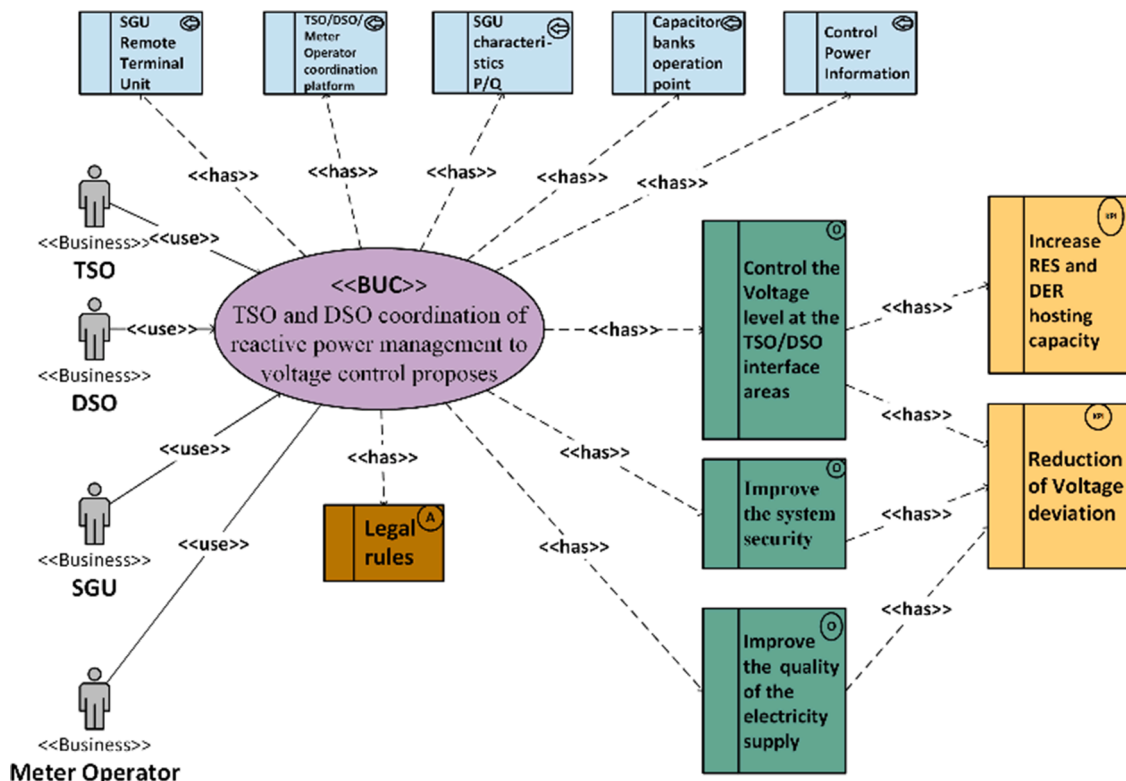

Fig. 1. Proposed BUC overview.

6. Standardized BUC mechanism

In this paper, a voluntary scenario, where the DSO agrees with the TSO participation in voltage control, is considered and analyzed. In this case, the voltage control tools available at the DSO's network can be controlled by the DSO's control operators upon notification by the TSO in both real-time and operational planning. Then, the TSO notifies the DSO regarding the required reactive power value and its duration at each primary substation at different time frames, such as several hours or days ahead. The DSO, on its part, tries to achieve the set point requested by the TSO by activating its flexibilities, viz. OLTCs, capacitor banks, and reactors. Specifically, in this activation process, the DSO defines:

- The reactive power that can be absorbed or supplied by the SGU connected to the MV networks.
- The reactive power that can be injected/absorbed by the capacitor banks and reactors.
- The adjustment of the OLTC of the transformers to avoid constraints in the distribution network.

Even if the DSO cannot achieve the set point by following the described activation process, it will try its best to be as close as possible to the target. The different steps involved in this scenario are shown in Fig. 2, and described as follows:

- Step 1- To solve the constraints on its network, the TSO asks the DSO to respect reactive power set points at a primary substation during a period of time. These set points are sent during the operational planning time frame and should include the time of activation.
- Step 2- A list of concerned SGU and DSO-owned flexibilities, such as OLTCs, capacitor banks, and reactors, is established.
- Step 3- The SGU sends the power measurements to the DSO.
- Step 4- In real-time, the DSO should define the reactive power set point for the SGU and the DSO-owned flexibility. In order to do so, it should know the P/Q diagram and measurements of the SGU, as well as the operation point of the OLTCs, capacitor banks, and reactors.
- Step 5- The SGU applies set point.
- Step 6- The DSO controls the required application of power.
- Step 7- The Meter Operator sends the power measurements to the TSO and DSO.
- Step 8–9: The DSO and TSO, respectively, monitor the measurements.
- The information exchanged after following the above described steps is detailed in Table 1.

7. Simulation experiments

In order to practically evaluate the performance of the proposed decentralized TSO-DSO coordination approach presented in terms of the standardized BUC developed in Sections 4,5, and 6, different simulation experiments on a real-world Slovenian transmission and distribution grid models are conducted. The experimental simulations conducted are twofold. On one hand, data is exchanged as a CIM CGMES format to validate the proposed data exchange mechanism based on the BUC. On the other hand, the capability of the proposed decentralized TSO-DSO coordination approach implemented via the standardized BUC to manage the reactive power injected by the RES distributed within the boundaries of the DSO for regulating the voltage at the TSO's side is evaluated. In particular, sensitivity and robustness analyses are conducted by testing the proposed approach within the context of different reactive power injection scenarios, including capacitor banks and different types of DGs, such as hydropower, PV, and thermal (co-generation) units, for different network topologies, DGs' operating scenarios, and capacitor banks' sizes and locations.

7.1. Grid models description

The models of the HV and MV networks used to conduct the simulation experiments are based on the Slovenian system operators ELES and EG, respectively. Figs. 3 and 4 show the considered HV voltage and MV-Low Voltage (LV) networks, respectively.⁴ The HV network is represented by the whole Slovenian HV network, including all 110 kV, 220 kV, and 400 kV nodes/bus bars along with their connecting elements, such as transformers and lines. In addition, the generating units connected to the HV network are also considered. For the MV network, the grid of Gorenjska region is considered. This grid is modelled using equivalent nodes in each Transformer Station (TS) as follows. The HV/MV transformer tap changers hold the voltage on the MV side at a constant value of 20 kV. Here, it is important to note that, although in the practice the regulated voltage is usually a bit higher, using a fixed value of 20 kV has little effect on the simulation results. Each HV/MV transformer is modelled by an equivalent MV feeder. Although some TSs connected to larger MV networks can have additional feeders, they usually have one to three feeders. In this way, each TS is modelled by one to three feeders. Finally, each feeder is modelled by two equivalent loads representing the peak consumption in the area, and three generating units, representing equivalent DGs, viz. hydropower, PV, and thermal (co-generation) units, from all the sources dispersed in the real MV network.

7.2. Network topologies description

Two different reactive power sources in the DSO's MV grid are considered, namely DGs, including hydropower, PV, and thermal units, and capacitor banks. In general, the DGs are dispersed in the MV grid, making it difficult to assess their reactive power contribution to the HV grid. On the other hand, although capacitor banks can be installed anywhere in the MV grid, which can limit their nominal power, they are commonly installed on the MV feeder in the TS. In this paper, the simulation experiments evaluate the contribution of the DGs and the capacitor banks installed at the MV side of a particular TS to the voltage regulation of the HV side at the same TS, for all the TSs in the Gorenjska region of the Slovenian network.

The injection of additional reactive power into the system raises both MV and HV side voltages. Since, according to the network model introduced in Section 7.1, the MV side voltage is regulated to a constant value (20 kV), the reactive power will mostly influence the HV network voltage. Three different network topologies are considered to conduct the simulation experiments toward evaluating the influence of the different RES in the MV network on the HV network voltage and the capability of the proposed approach to manage this influence for controlling the HV voltage. These topologies represent the network at its operational limits, where voltage regulation is significantly needed. In particular, the three simulated topologies are as follows:

- High consumption and high short-circuit power topology: In this topology, most of the units and lines are in operation, being the consumption of about 1800 MW.
- Low consumption and lower short-circuit power topology: In this topology, the consumption is about half of peak consumption (900 MW), and only a limited number of units are in operation. In addition, some of the parallel 400 kV lines have one system switched off.
- Weak system topology: In this topology, the system is bordering on its collapse. Some units and lines in the three HV levels (110 kV, 220 kV, and 400 kV) are disconnected after an event. The short-circuit power in the nodes is, therefore, the lowest.

⁴ The representative diagrams in Figs. 3 and 4 have been built based on the real networks. Nevertheless, the real networks have not been included in this paper since they contain data that are not permitted to be published.

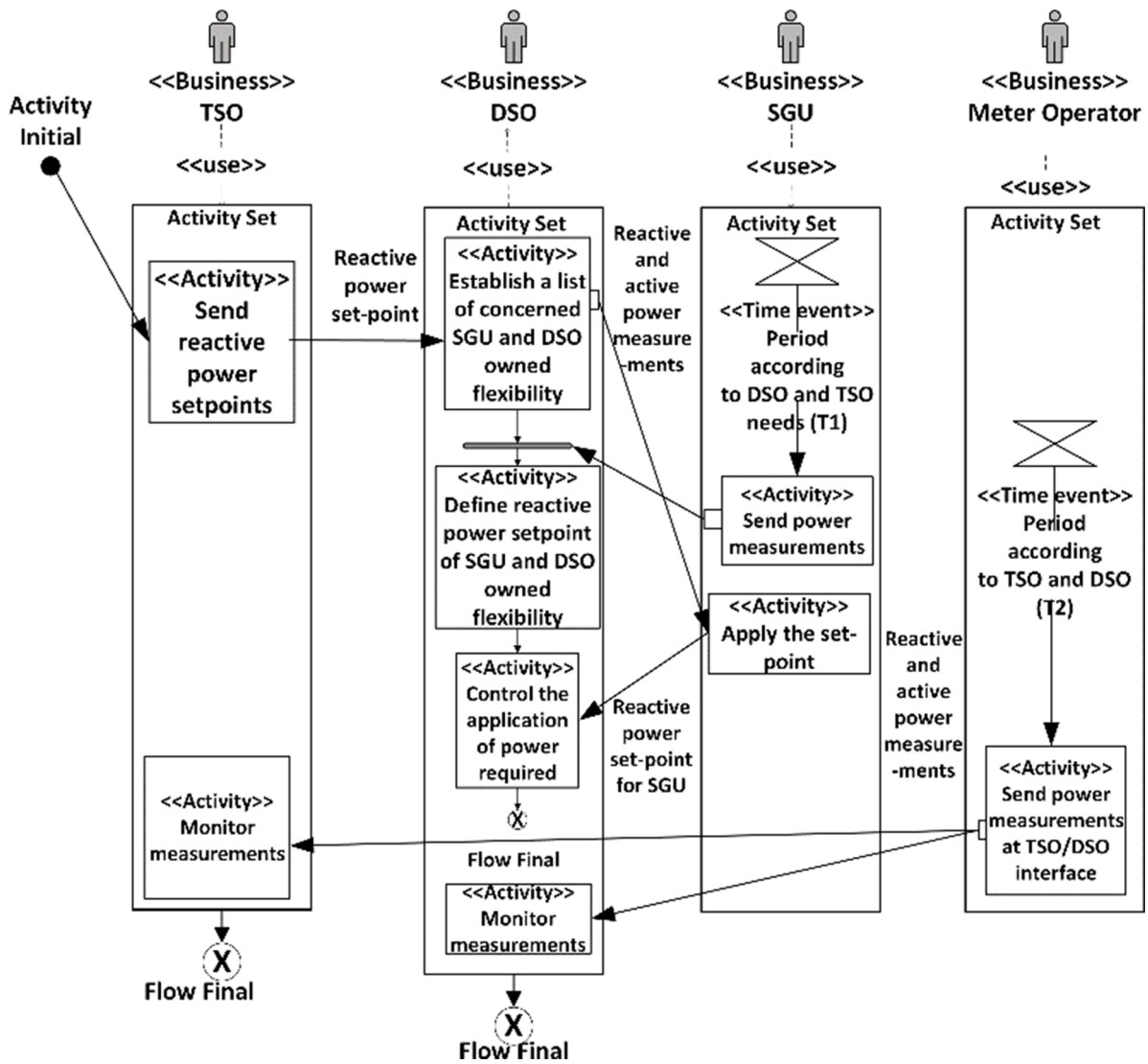

Fig. 2. TSO notifies the DSO to participate in voltage control.

Table 1
Exchanged information.

INFO ID	Type	Description	BUC stage	From-To
INFO 4	Q set- point	The Q set point is given in terms of Q (MVar), tg φ or P/Q diagram (MW/MVar). Each of these set points should be respected by primary substation and during a specific period.	Step 1 Step 6	TSO-DSO DSO
INFO 5	Q and P measurements	Q (MVar) and P (MW).	Step 3 Step 7	SGU-DSO Meter Operator-TSO Meter Operator-DSO

7.3. Experimental simulations

Fig. 5 shows the flowchart of the simulations conducted in this paper for assessing the contribution of the different reactive power sources, namely DGs and capacitor banks, in the DSO’s network to regulate the

voltage in the TSO’s network. In particular, a Load Flow (LF) analysis is performed based on the existence of these reactive power resources (injections) to check their effect on the considered voltage nodes at the HV side shown in Fig. 3, for all the TSs in the Gorenjska region of the Slovenian system.

The input data for the simulations consist of data files containing the network topology, impedances, and all other information related to the DSO’s and TSO’s networks. These input data are then converted to the PSS@E format⁵ (.raw data files) which can be imported by the PSS@E software and used for PF simulations.

A separate Python script oversees and automates all the conducted simulations by interfacing PSS@E through a library of APIs. In this way, the user is allowed to select which of the three topologies described in Section 7.2 he/she wants to simulate. Each scenario is automated in the script file. In particular, for each separate simulation, the Python APIs call different PSS@E modules. For instance, modules for PF data changing that enable changing of line impedances, type of transformer regulation with taps and power of capacitors, or PF calculation APIs

⁵ https://pssstore.siemens.com/store;jssessionid=B2E3186B3DC87F2E4E31DE95DE3D62E9?Action=list&Locale=es_ES&SiteID=sipti&categoryId=4844334200

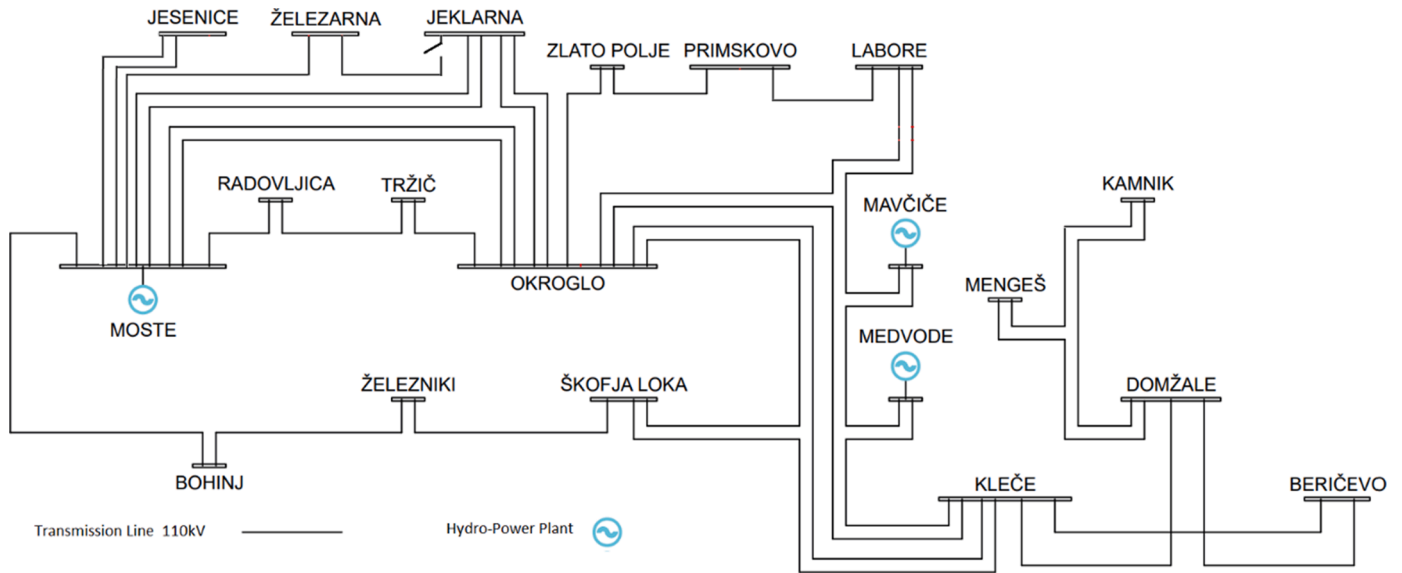

Fig. 3. HV network.

7.4. Robustness and sensitivity analyses

In this paper, robustness and sensitivity analyses are conducted to evaluate the capability of the proposed approach to manage the contribution of the different considered RES, namely DGs, including hydropower, PV, and thermal (co-generation) units, and capacitor banks, distributed through the MV grid toward regulating the HV voltage for the different topologies described in Section 7.2. In order to do so, the simulation experiments evaluate the individual as well as the cumulative contribution of the DGs and capacitor banks installed at the MV side of a particular TS to the voltage regulation of the HV side at the same TS for all the TSs in the Gorenjska region of the Slovenian system.

In the first place, a sensitivity analysis is conducted to evaluate the impact of the DGs, including hydropower, PV, and thermal (co-generation) units, and capacitor banks in the HV voltage for the three different topologies described in Section 7.2. Then, a robustness analysis is conducted on the same topologies to evaluate to which extent the proposed decentralized TSO-DSO coordination approach is capable of regulating the HV voltage under the different simulated scenarios. In the DGs case, the sensitivity analysis is conducted on the following three different operating situations to evaluate their influence on the HV voltage:

- No operation ($P = 0, Q = 0$).
- Operation with maximum active power and no reactive power ($P = P_{max}, Q = 0$).
- Operation with maximum active and reactive power ($P = P_{max}, Q = Q_{max}$).

Then, the capability of the proposed approach to keep the HV voltage controlled in these three operating situations is evaluated through a robustness analysis.

In the case of the capacitor banks, the sensitivity analysis is conducted to evaluate the impact of varying the value of their main parameters in the HV voltage, as follows:

- Nominal power (size): The capacitors' nominal power is increased with 1Mvar steps from 0Mvar (capacitor not in operation) to 5Mvar.
- Locations in the MV network: The capacitors are placed at different points in the MV network. In this case, a detailed analysis is performed for the Primskovo TS model, placing the capacitors at different points along the length of both substations' feeders. This model includes all MV lines, MV to LV transformers, and LV loads.

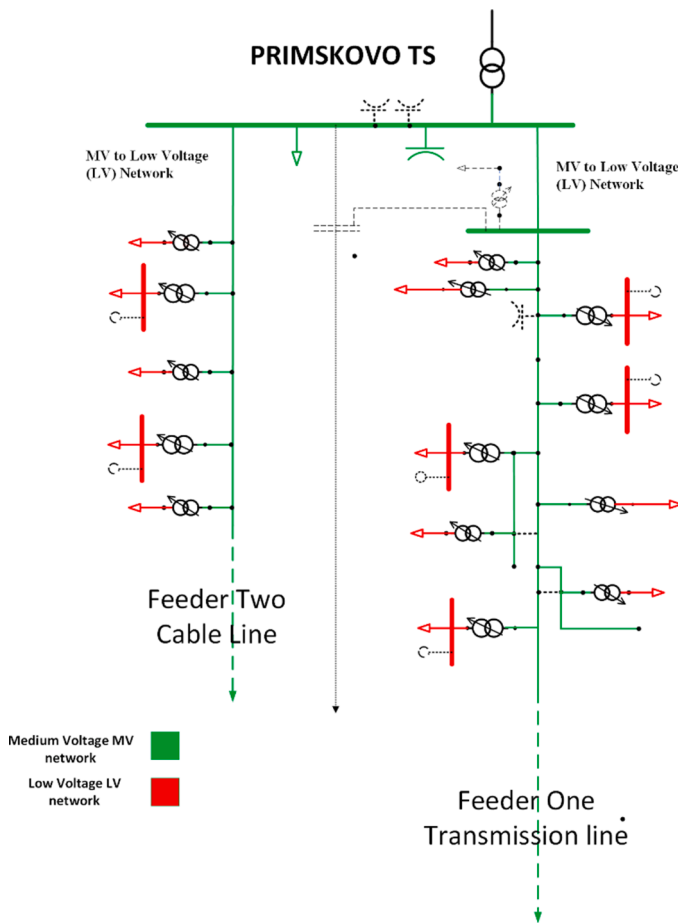

Fig. 4. MV and LV networks.

which call PF calculation module with a set of parameters. After the PF calculation is done, the PSS@E stores the results in its output (.out) files.

The simulation loop ends once the calculation for each given parameter is performed. Then, a data retrieval API collects the results from the .out files and enables the evaluation and visualization of the results with *ad hoc* Python routines.

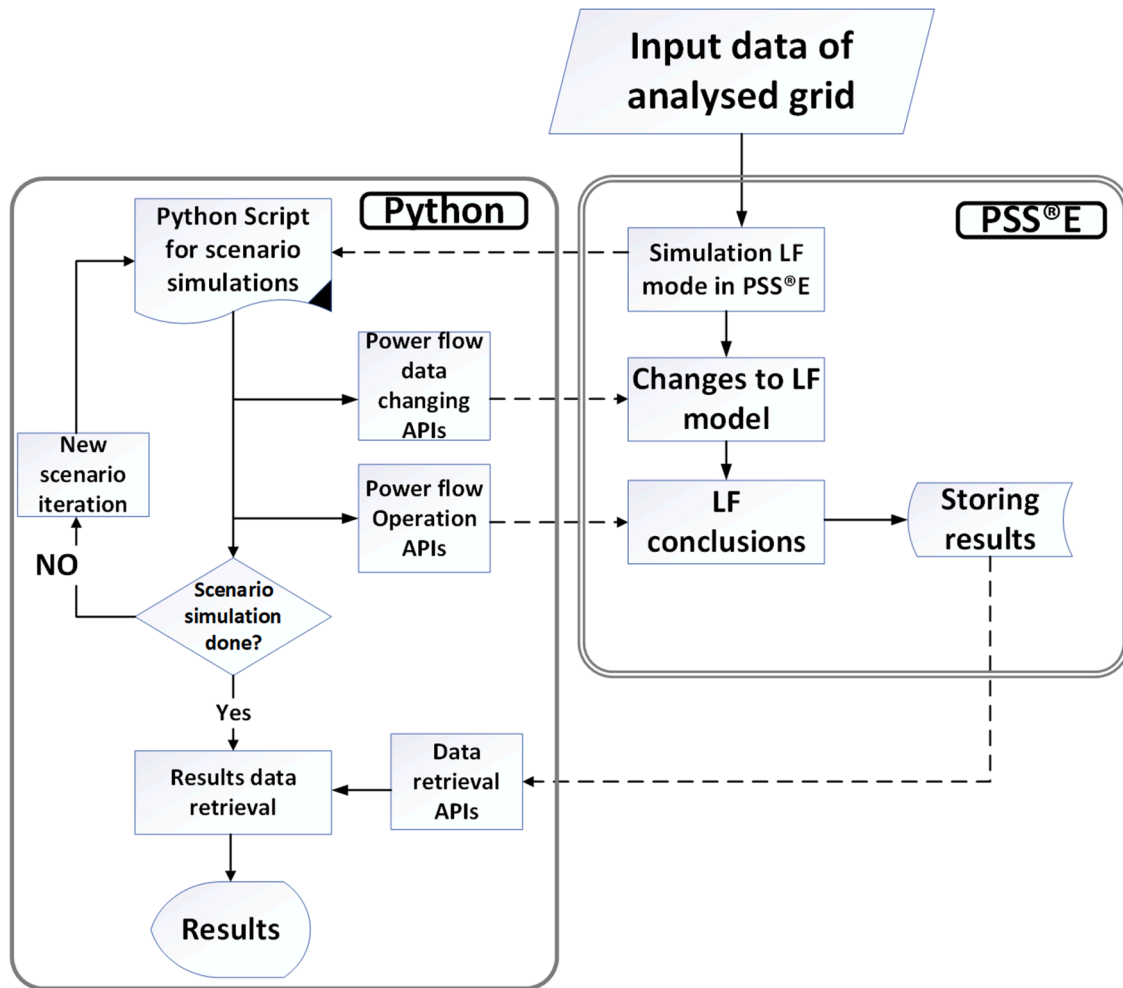

Fig. 5. Simulation flowchart.

One of the feeders is a long overhead line, whereas the other is a shorter cable line. MV/LV transformers are distributed along both of the lines and provide power to consumers, modelled as constant PQ loads, in the LV network.

7.5. Comparison with similar state of the art approaches

The main features of the decentralized TSO-DSO coordination approach proposed in this paper rely on specific criteria, and the obtained results are measured based on the effect of different distributed RES, including DGs, viz. hydropower, PV, and thermal (co-generation) units and capacitor banks, on the HV voltage. Table 2 compares these main features with the ones corresponding to similar studies in the state of the art performing voltage regulation.

All the studies included in Table 2 evaluate, to some extent, the effect of DGs on the voltage at different points in the grid. Nevertheless, they differ in several technical aspects. In [41] and [42], the effects of different DGs are studied on the same network; in [45], these effects are studied on the distribution network; and in [43], they are studied in the connection point of distribution grid to transmission PCC. Only [44] assesses the impact of the DGs on the HV voltage. In this paper, not only the impact of the DGs on the HV voltage but also the impact of capacitor banks is analyzed. In addition, the analysis is not limited to track the effects of the RES installed on the PCC as in the case of [43], but it considers different operating conditions of the DGs and different sizes and locations of the capacitor banks in the MV and LV networks. Moreover, the conducted sensitivity analysis evaluates different loading

scenarios, which reflect the extreme cases of the network, to provide a clear picture of the voltage profile of the whole network.

In order to mitigate the detected impact of RES on the HV voltage, this paper introduces a novel approach where a standardized agreement between the TSO, the DSO, and other stakeholders, such as the SGU and the Meter Operator, implemented via a BUC, allows to manage the injected reactive power for voltage regulation purposes. The proposed BUC is demonstrated on real-world TSO's and DSO's networks rather than on artificial simulated networks, as in the case of [41] and [44]. In this way, a valuable contribution to the literature is done by providing benchmark results obtained on a standardized basis and a real-world network.

8. Results and discussions

In this section, the results of the sensitivity and robustness analyses performed based on the different simulation experiments described in Section 7 are presented and discussed.

8.1. Sensitivity analysis of DG reactive power sources

The experimental simulations are conducted taking into account the different topologies described in Section 7.2 and the different operating situations described in Section 7.4. To this end, the maximum values of the active and reactive power of the different DGs distributed in the studied Slovenian region are calculated based on their measured highest powers. These values are shown in Table 3. Here, it is important to

Table 2
Feature comparison with other state of the art approaches performing HV voltage regulation.

Study	Used network	Effect location	Main aim	Simulation Methodology	KPIs
[41].	IEEE 34-bus test system	Same network	Evaluate the impact of the connection of distributed generation on the voltage stability problem, active power loss, and voltage profile	Connectivity analysis	Evaluate voltage stability problems
[42].	One-line diagram of local Massachusetts study area.	Same network	Assessing the impact of DG tripping on the voltage stability of a regional transmission system.	Sensitivity cases	<ul style="list-style-type: none"> Minimize the risks of unintentional islanding. Evaluate voltage stability problems.
[43].	A modified and extended model of the existing distribution grid in Germany	The connection point of distribution grid to transmission PCC	Considers an alternative way of voltage and reactive power managing and discovers possibilities of PV converters in MV and LV grids with a different type of control to solve this problem of voltage levels	Operational scenarios such as Constant Q, P and Constant V	Examine the possibilities of converters of PV panels in LV and MV grids to control reactive power and voltage at the PCC
[44].	A simplified model of the EU power system	Effect on the HV networks	Studying the effect of increased photovoltaic power generation in the European high voltage transmission network	Two scenarios for additional PV installed capacity have been implemented	Analysing the effect of high penetration of PV generation into the HV European grid, Register and present the effect of voltage due to operation of DG and power loss in long distribution
[45].	Distribution of Provincial Electricity of Thailand	Distribution system	Track the effect of Distributed Generation on Very Long Distribution Line with Automatic Voltage Regulator	Different loading scenarios: <ul style="list-style-type: none"> Case 1: Voltage at light load Case 2: Voltage at peak load Case 3: Power loss at light load and peak load 	
Proposed decentralized TSO-DSO coordination approach based on the standardized BUC	Slovenian TSO's and DSO's networks HV, MV, and LV	The effect of MV and LV on the HV	Decentralized TSO-DSO Coordination for Voltage Regulation Purposes based on Renewable Energy Sources Management.	Sensitivity and robustness analyses for different DGs and capacitor banks within different loading scenarios	<ul style="list-style-type: none"> Track of HV voltage deviation Track of the RES and DER hosting capacity

Table 3
Largest measured active and reactive powers of DG units in the EG DSO's network (Gorenjska region).

Technology	Maximum P (MW)	Maximum Q (Mvar)
Hydropower	20.9	7.0
PV	14.6	4.8
Thermal	16.5	5.5
Cumulative	52.0	17.3

highlight that the simulations conducted in this section have been mainly focused on the simultaneous operation of all the DG sources in the region of Gorenjska, since it has been found that DGs in individual TSs have a negligible effect on the surrounding TSs.

- High consumption and high short-circuit power topology:

Fig. 6 shows the effect of DGs on all the nodes in the HV voltage (110 kV) for the highest short-circuit power topology described in Section 7.2, and the three DG conditions listed in Section 7.4, viz. no operation (black), operation with maximum active power and no reactive power (blue), and operation with maximum active and reactive power (red). In particular, Fig. 6 (a) shows the voltage level in the HV network for the different situations, whereas Fig. 6 (b) shows the relative increment (ΔU (%)) of the HV voltage. The results in Fig. 6 (b) show that the active power increases the voltage in the HV network by about 0.4 kV in all nodes, while the contribution of the reactive power increments the voltage by about 0.6 kV, being even higher in some nodes, such as the one of Bohinj, where the increment is about 0.8 kV. Taking into account the total voltage increment (in red in Fig. 6), DGs increase the voltage by 1–1.5 kV, which corresponds to 0.4–0.5% and 1–1.4% for purely active power and reactive power production, respectively. Since the topology analyzed in this case is associated with the largest powers, which are not

expected to appear simultaneously for all technologies, it can be assumed that the relative increase of the HV voltage will be substantially smaller during the real operation.

- Low consumption and lower short-circuit power topology:

The simulation experiments for this topology have shown results that are very similar to the ones obtained in the case of the high consumption topology analyzed above. In this line, the same comments stand. Due to space limitations, the figure showing the effect of DGs on all the nodes in the HV voltage, in terms of its absolute value as well as its increment, for the three DG operating conditions, has not been included in the paper.

- Weak system topology:

Fig. 7 shows the effect of DGs for the weak system topology described in Section 7.2 and the three DG conditions listed in Section 7.4, viz. no operation (black), operation with maximum active power and no reactive power (blue), and operation with maximum active and reactive power (red). Since this topology corresponds to a lower short-circuit power in the network, the effect of active and reactive power injections of DGs on the HV voltages is more significant than in the case analyzed in Fig. 6. In particular, from Fig. 7 it can be seen that, compared to the case where no DGs are present (in black in Fig. 7 (a) and (b)), the operation of DGs can cause an increase in the HV voltage of 2–6%. Finally, it is important to highlight that this is a best-case topology, where all the DGs are in simultaneous operation and provide maximum expected active and reactive power in all TSs.

For the sake of comparison, Fig. 8 shows the relative HV voltage increase for the three topologies listed in Section 7.2 and analyzed above, obtained when DGs are operating, either with $P = P_{max}$ and $Q = 0$ (blue) or with $P = P_{max}$, $Q = Q_{max}$ (red). From Fig. 8, two main observations can be made:

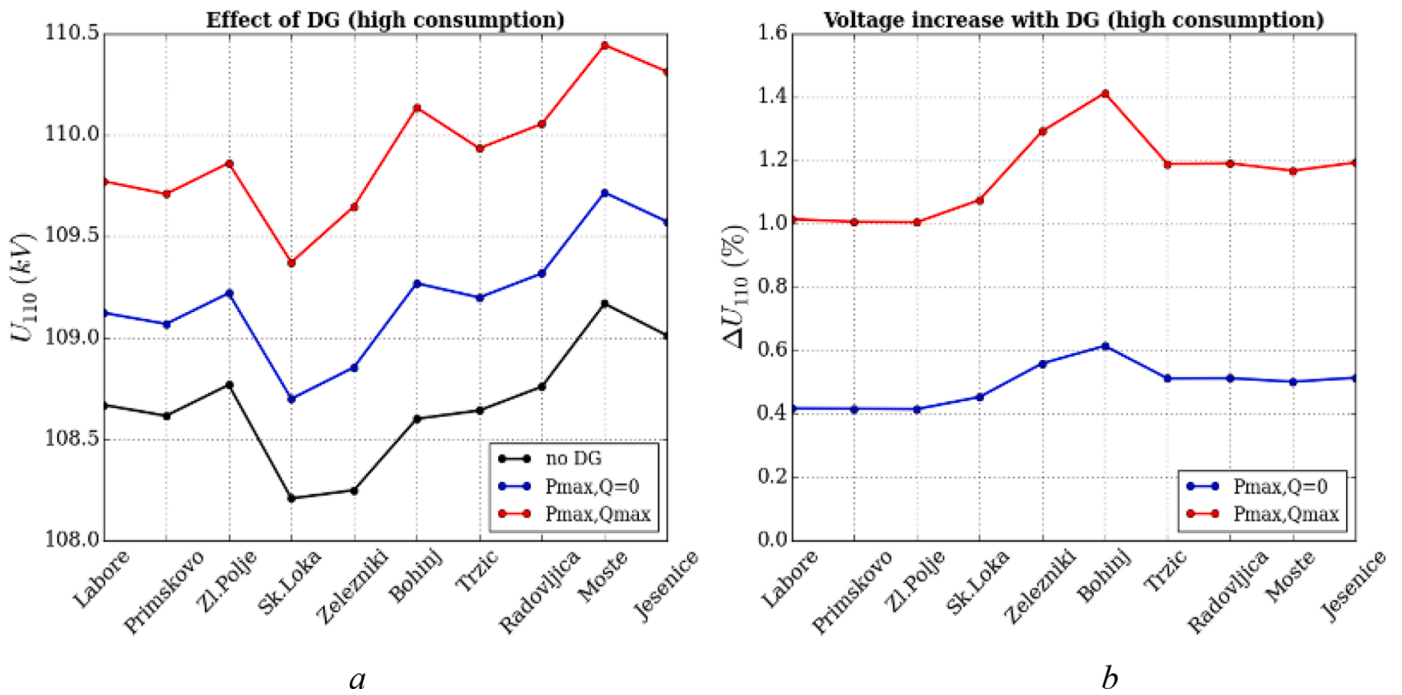

Fig. 6. Impact of DGs on the 110 kV HV voltages (high consumption topology). (a) Voltage level (kV) (b) Relative voltage increments ΔU (%).

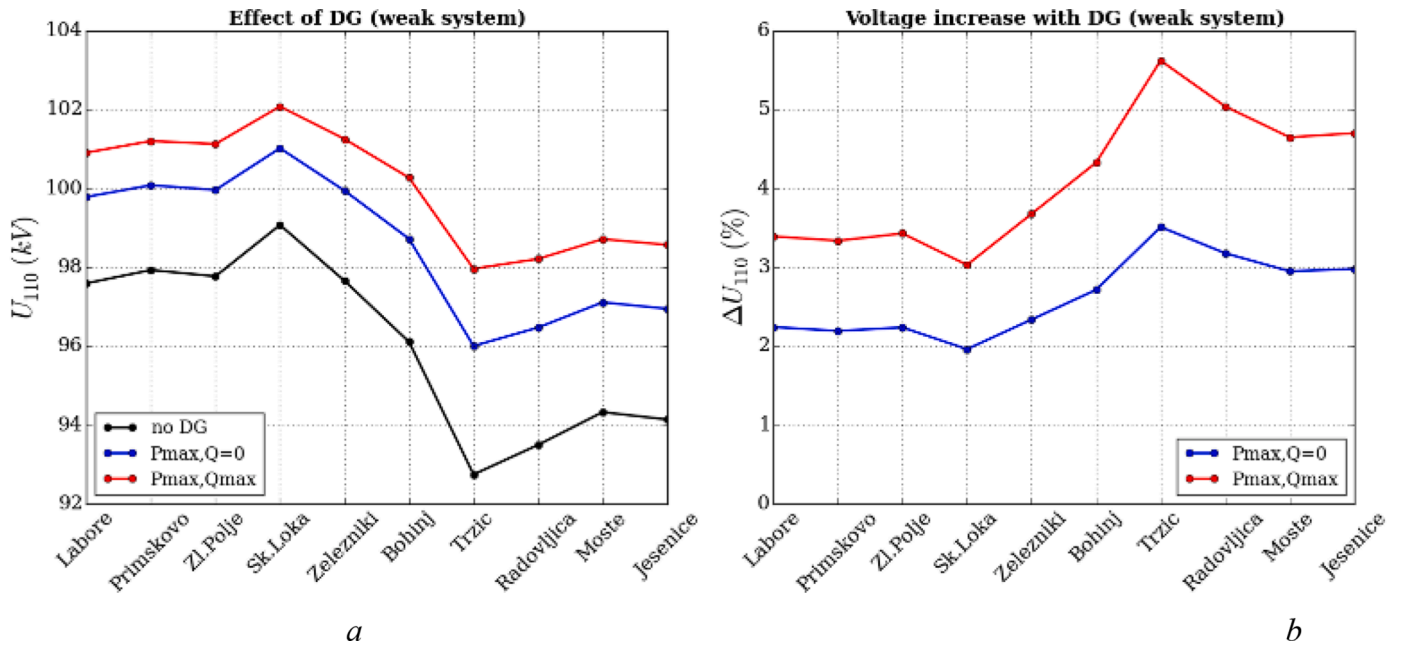

Fig. 7. Impact of DGs on 110 kV HV voltages (weak system topology). (a) Voltage level (kV) (b) Relative voltage increments ΔU (%)

- Regardless of the topology, the influence of the reactive power injected by DGs on the HV voltage is more significant than the influence of the active power.
- The influence of the power injected by DGs in the HV voltage is remarkably more significant in the case of the weak system topology than in the other two cases.

Based on these observations it can be concluded that the reactive power injected by the DGs has a significant impact on the HV voltage, especially within the context of the weak system topology scenario.

8.2. Robustness analysis of DG reactive power sources

Based on the simulation results shown in Figs. 6,7, and 8, the capability of the proposed approach of managing the reactive power contribution of the different considered DGs and regulating the HV voltage is evaluated. In particular, this capability is evaluated in terms of the two KPIs introduced in Section 4. The first KPI analyses the tracking of voltage deviation, whereas the second one analyses the deviation between the reactive PF and the required value. According to the results shown in Figs. 6–8, DGs are capable of contributing additional, either positive or negative, reactive power to reduce the voltage deviations in the grid. Moreover, it has been shown that, the weaker the system is, the

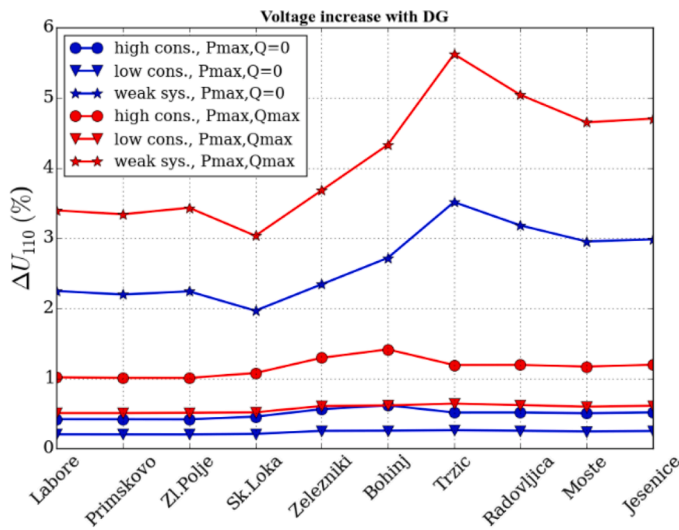

Fig. 8. Relative HV voltage increase with the two different strategies of DG operations in comparison with the case where no DGs are operating.

more significant the contribution of the DGs can be. In this way, the power quality can be improved, while keeping the HV voltage within safe values, by the contribution of DGs. This allows concluding that, in the analyzed cases, DGs lead to a positive impact on the first KPI. That is to say, DGs allow reducing the HV voltage deviation, making both MV and HV systems more secure. In addition, controlling DGs can reduce the flow of reactive power from the TSO's to the DSO's networks and vice versa, as the DG units supply reactive power demand of loads locally. In this way, a positive impact is also achieved on the second KPI (deviation between the reactive PF and the required value).

8.3. Sensitivity analysis of capacitor banks reactive power sources

8.3.1. Sensitivity analysis regarding nominal power (Size) of capacitor banks

- High consumption and high short-circuit power topology:

Fig. 9(a) and (b) show the absolute and relative voltage increase, respectively, at all the nodes in the HV voltage (110 kV) for the highest short-circuit power topology described in Section 7.2 and different sizes of capacitor banks (from 1Mvar (yellow) to 5Mvar (red)) installed in the Trzic TS. From Fig. 9, it can be seen that the influence of the capacitor banks in the HV voltage increases with their size for all the nodes in the grid. In addition, in this case, the nodes surrounding the Trzic TS with installed capacitor banks, experience a greater increase of voltage compared to other nodes. Nevertheless, even the largest HV voltage increase, which occurs in the Trzic node where the capacitors are installed, is low, being less than 0.3%.

- Low consumption and lower short-circuit power topology:

The simulation results for this topology do not differ significantly from the ones obtained in the case of the high consumption topology analyzed above. In this line, the same comments stand. Due to space limitations, the figure showing the absolute and relative voltage increase at all the nodes in the HV voltage for the different sizes of the capacitor banks has not been included in the paper.

- Weak system topology:

Fig. 10(a) and (b) show the absolute and relative voltage increase, respectively, at all the nodes in the HV voltage (110 kV) for the weakest system topology described in Section 7.2 and different sizes of capacitor banks (from 1Mvar (yellow) to 5Mvar (red)) installed in the Trzic TS. In this case, the same behavior of the case analyzed in Fig. 9 can be observed. The influence of the capacitor banks in the HV voltage increases with their size for all the nodes in the grid, occurring with the largest one at the Trzic node and the nodes surrounding it. Nevertheless, compared with the results in Fig 9 corresponding to the high

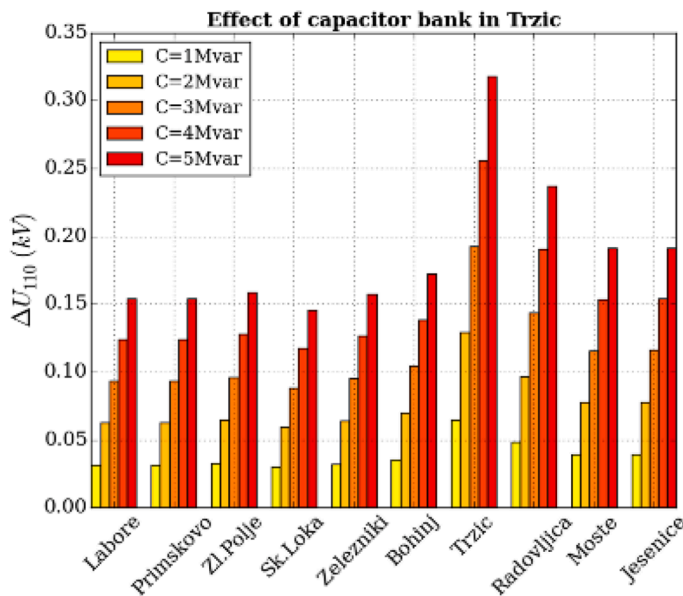

a

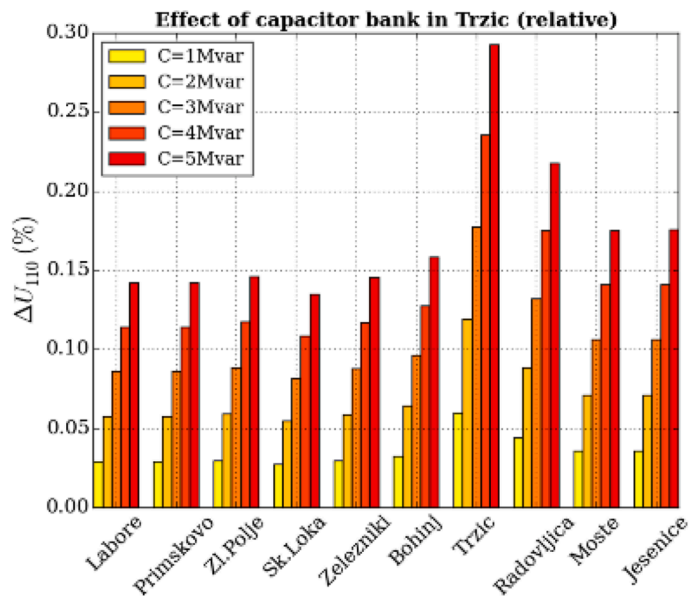

b

Fig. 9. Voltage changes in the HV network with installation of capacitor bank in Trzic TS (high consumption topology). (a) Absolute voltage increase (kV), (b) Relative voltage increments ΔU (%)

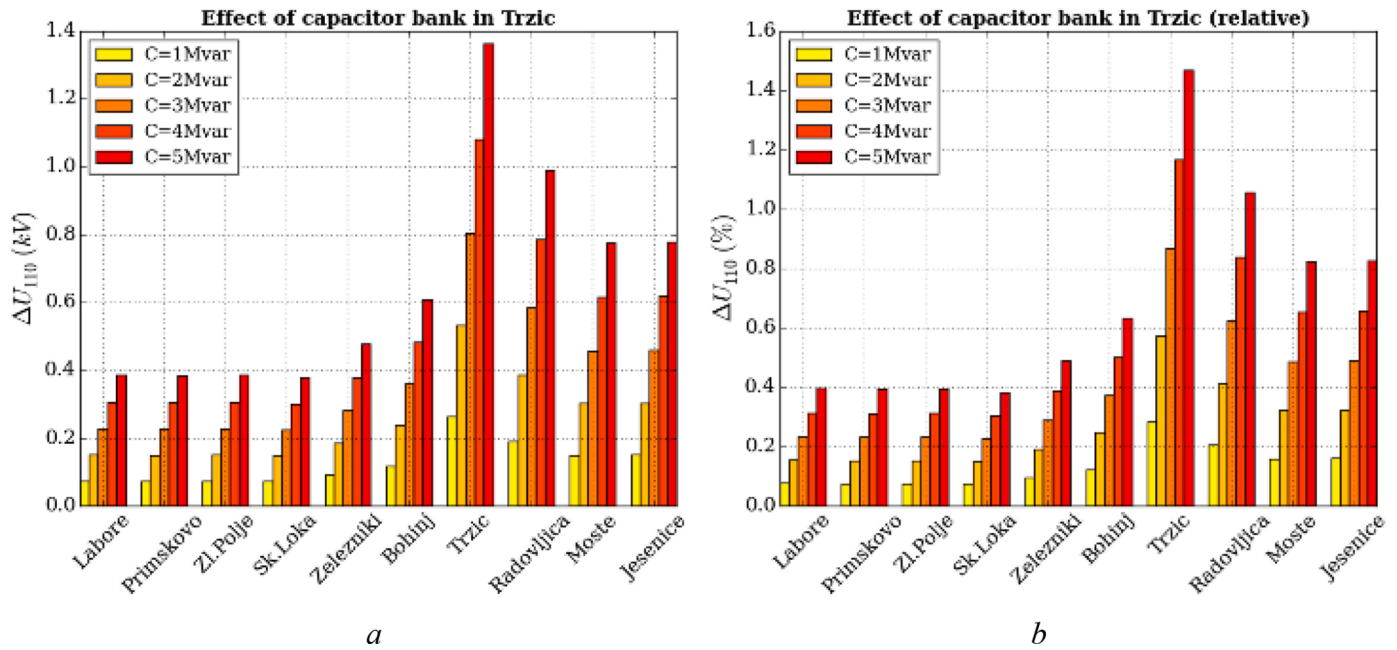

Fig. 10. Voltage change in the HV network with installation of capacitor bank in Trzič TS (weak system topology). (a) Absolute voltage increase (kV), (b) Relative voltage increments ΔU (%)

consumption topology, the influence of the capacitor banks in the HV voltage within the context of the weak system topology is more significant than in the other topologies, achieving an increment of 1.5%.

Fig. 11 shows the relative HV voltage increase linked to the installation of a 5Mvar capacitor bank at the MV side of each TS for the three topologies described in Section 7.2 and analyzed above (high consumption (light blue), low consumption (green), weak system (orange)). In the case analyzed in Fig. 11, the capacitor banks in the TSs are not operating simultaneously. The obtained results show that HV voltage changes are only perceived in a particular TS when the capacitors are installed in that TS, and not in the surrounding ones. In normal operating conditions, i.e. the high and low consumption ones, the relative HV voltage increase does not exceed 0.4%. On the other hand, within the weak system topology context, the capacitor banks have the most significant influence on the Trzič TS, where the capacitors are installed. This is due to the specific topology of the Trzič TS, which causes this TS

to have the lowest short-circuit power on its HV side.

Fig. 12 shows the relative HV voltage increase when 5Mvar capacitor banks are operating in all stated TSs simultaneously for the three topologies described in Section 7.2 and analyzed above (high consumption (light blue), low consumption (green), weak system (orange)). In this case, the HV voltage increase in all the network nodes is greater than in the case where the capacitor banks are installed only in one TS (shown in Fig. 11). Nevertheless, the relative HV voltage increase for normal operating conditions, i.e. the high and low consumption topologies, is still rather small and does not exceed the 2%, being the capacitors' contribution more significant in the weak topology.

8.3.2. Sensitivity analysis regarding capacitor banks location

The influence of the capacitor banks installed along the two feeders of the Prmskovo TS model, namely the cable and the overhead lines, is evaluated. Fig. 13 (a) and (b) show the relative HV voltage for four

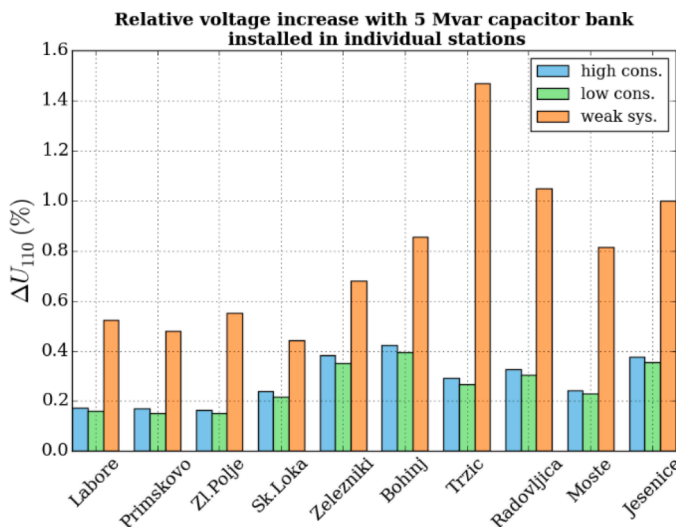

Fig. 11. A comparison between the considered three consumption topologies for the influence of 5Mvar capacitor banks in individual TS.

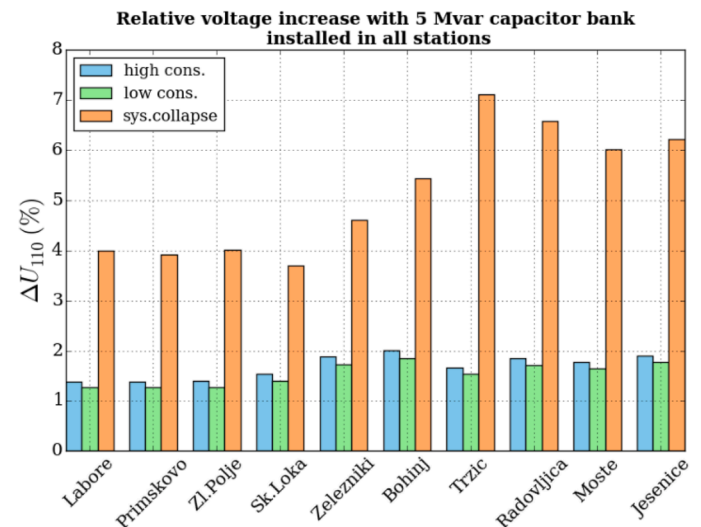

Fig. 12. Relative HV voltage increments with 5Mvar capacitor banks installed simultaneously in all TSs.

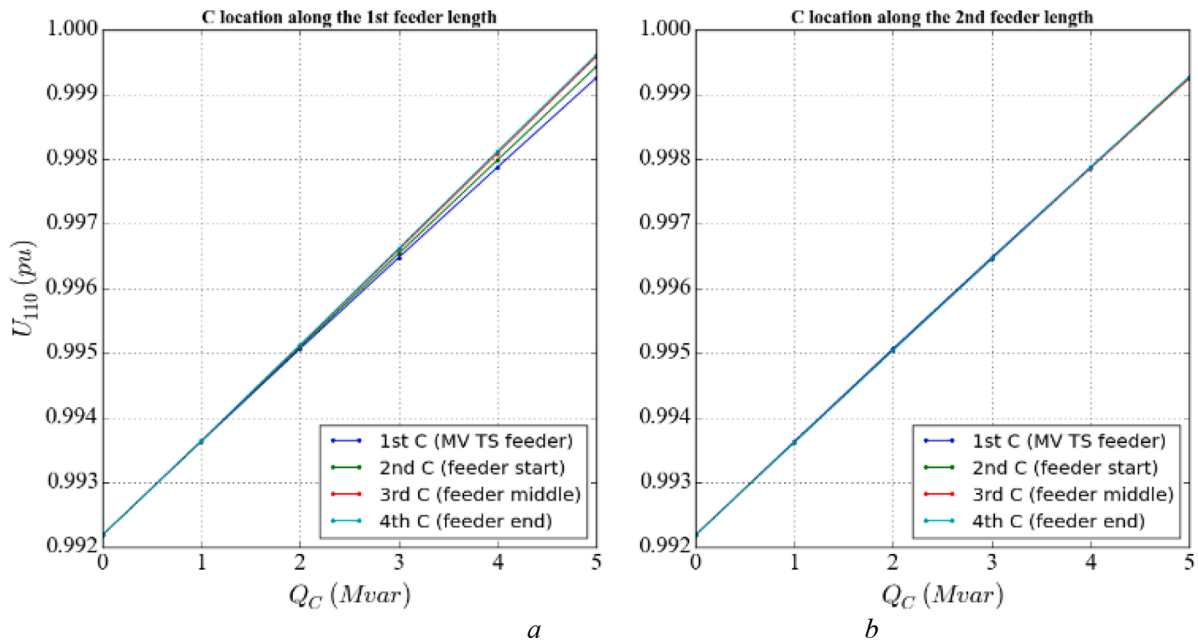

Fig. 13. Relative HV voltage increases with capacitor banks installed along the length of two feeders in Primskovo TS. (a) First feeder (b) Second feeder.

different locations of the capacitors for the first and second feeders, respectively. The results in Fig. 13 show that the location of the capacitors has a minimal influence on the HV voltage. This is due to the fact that the MV busbars in the TS are regulated to a constant value. Note to the reader that, according to the network model used for the simulation experiments described in Section 7.1, the MV network voltage cannot change, making the additional reactive power generated by the capacitors to influence only the HV voltage. On the other hand, simulation experiments have also shown that the location of the capacitors highly influences the power losses in the DSO's grid, being significantly higher when installing a capacitor at the feeder end (0.8 MW) than when installing it at the MV feeders in the TS (less than 0.1 MW). This difference is mainly due to the reactive PF in the lines.

8.4. Robustness analysis of capacitor banks reactive power sources

The robustness of the proposed approach against the different capacitor banks' sizes and locations described in Section 7.4 within the context of the different topologies described in Section 7.2 to keep HV voltage controlled is evaluated in terms of the two KPIs introduced in Section 4. Simulation experiments have shown that the proposed approach can reduce both deviations of reactive PF and deviation of voltages in the grid when capacitor banks are considered. Nevertheless, it is important to highlight that, unlike DGs, capacitor banks are only able to produce and not consume reactive power. In this sense, capacitors cannot be used for reducing/compensating the excesses of reactive power flowing from the MV to the HV network, which is usually the case in distribution grids with a large number of cables. Then, the overall impact of capacitor banks depends on their size and grid topology, being necessary to be studied in a case-by-case approach.

9. Conclusions

In this paper, a new technology-agnostic approach for a decentralized TSO-DSO coordination capable of scheduling and deploying optimal reactive power exchanges in the DSO's boundary for improved voltage control in the TSO's networks has been proposed. The proposed approach was implemented via a well-structured and standardized BUC designed and developed within the framework of the IEC CIM family of standards IEC61970, IEC61968, and IEC62325. In order to bridge the

gap in the literature regarding the lack of pilot tests in the field, the proposed standardized BUC was demonstrated on real-world Slovenian TSO's and DSO's networks. Although the particular studied grid corresponds to the Slovenian Gorenjska region, the conclusions can be generalized to any other network since the experimental methodology followed in this paper is generic, replicable, and free of restrictive assumptions.

The experimental simulations conducted in this paper allowed to demonstrate the main pillars of the proposed decentralized TSO-DSO coordination approach based on the standardized BUC. On one hand, the proposed data exchange mechanism based on the BUC was validated by successfully exchanging data between the TSO, the DSO, and the other stakeholders considered in the BUC, namely the SGU and the Meter Operator, as a CIM CGMES format. On the other hand, the capability of the proposed approach to regulate the HV voltage by managing the reactive power injected by different RES, such as capacitor banks and the different considered DGs, viz. hydropower, PV, and thermal (co-generation) units, was validated for different network topologies, DGs' operating scenarios and capacitor banks' sizes and locations. In particular, sensitivity and robustness analyses were conducted.

The sensitivity analysis based on the experimental results obtained for the Slovenian TSO and DSO have shown that the DGs studied in this paper can influence the HV voltage only in a large penetration situation and when producing high amounts of reactive power. In particular, it has been observed that their contribution is more significant when the network is operating in a weakened or even collapsing state. In this scenario, the robustness analysis showed that DGs are capable of contributing additional (positive or negative) reactive power to reduce the voltage deviations in the grid. This allows to conclude that successfully managing them based on the decentralized TSO-DSO coordination approach based on the standardized BUC proposed in this paper can improve the power quality at the DSO's boundary, while keeping the HV voltage within safe values. In addition, by controlling DGs at the DSO's boundary, the proposed decentralized approach can reduce the flow of reactive power from the TSO's to the DSO's networks and vice versa since the DG units supply reactive power demand of loads locally.

Unlike DGs, capacitor banks are only able to produce reactive power, being not able to reduce or compensate the excesses of reactive power flowing from the MV to the HV network, which is usually the case in

distribution grids with a large number of cables. In this context, simulation results have shown that the overall impact of capacitor banks highly depends on their size and location, being highly advisable to install them at the MV side of the TS to avoid potential overloading of lines and to reduce grid losses. In this scenario, the study of the robustness of the proposed approach to regulate HV voltage by managing the reactive power injected via capacitor banks should be performed on a case-by-case basis.

Finally, it is the authors' intention to extend the sensitivity and robustness analyses conducted in this paper to study not only the voltage profile but also the Optimal PF (OPF) and Economic Dispatch (ED), considering different aspects, such as power congestion and economic dispatch, within the context of different RES penetration in the distribution grid. In addition, the feasibility of using forecasting techniques to predict the impact that the different RES can have on the HV voltage as well as on the OPF is intended to be evaluated toward using such predictions for improving the TSO-DSO coordination performance.

CRedit authorship contribution statement

Mohammed Radi: Conceptualization, Methodology, Writing – original draft, Validation, Formal analysis. **Nermin Suljanovic:** Conceptualization, Visualization, Investigation, Formal analysis. **Miloš Maksić:** Software, Validation. **Gareth Taylor:** Project administration, Supervision. **Ioana Pisica:** Writing – review & editing. **Andrej Souvent:** Supervision.

Declaration of Competing Interest

The authors declare that they have no known competing financial interests or personal relationships that could have appeared to influence the work reported in this paper.

Acknowledgments

This paper is based on TDX-ASSIST project that has received funding from the European Union's Horizon 2020 research and innovation program under grant agreement No 774500.

References

- [1] G. Di Lembo, V. Agnetta, G. Fiorenza, G. Giannuzzi, Integration of DSO control systems and TSO automatic load shedding system to improve the security of the national grid, IET Conf. Publ. (2009) 8–11, <https://doi.org/10.1049/cp.2009.0703>, no. 550 CP.
- [2] Z. Li, J. Wang, A distributed transmission-distribution-coupled static voltage stability assessment method considering distributed generation, IEEE Trans. POWER Syst. 33 (2018).
- [3] A. Mohantya, M. Viswandyayaa, D. Mishraa, P. Paramitab, S.P. Mohantya, Intelligent voltage and reactive power management in a standalone PV based microgrid, in: SMART GRID Technologies, 2015.
- [4] H. Sun, et al., Review of challenges and research opportunities for voltage control in smart grids, IEEE Trans. Power Syst. 34 (2019).
- [5] N. Mahmud, A. Zahedi, Review of control strategies for voltage regulation of the smart distribution network with high penetration of renewable distributed generation, Renew. Sustain. Energy Rev. 64 (2016) 582–595, <https://doi.org/10.1016/j.rser.2016.06.030>.
- [6] H. Qamar, H. Qamar, A. Vaccaro, N. Ahmed, Reactive power control for voltage regulation in the presence of massive pervasion of distributed generators, in: 2017 IEEE International Conference on Environment and Electrical Engineering and 2017 IEEE Industrial and Commercial Power Systems Europe (IEEEIC /I&CPS Europe), 2017, pp. 1–5, <https://doi.org/10.1109/IEEEIC.2017.7977800>.
- [7] E. Demirok, D. Sera, R. Teodorescu, P. Rodriguez, U. Borup, Clustered PV inverters in LV networks: an overview of impacts and comparison of voltage control strategies, in: 2009 IEEE Electrical Power & Energy Conference (EPEC), 2009, pp. 1–6, <https://doi.org/10.1109/EPEC.2009.5420366>.
- [8] K.E. Antoniadou-Plytaria, I.N. Kouveliotis-Lysikatos, P.S. Georgilakis, N. D. Hatziarziou, Distributed and decentralized voltage control of smart distribution networks: models, methods, and future research, IEEE Trans. Smart Grid 8 (6) (2017) 2999–3008, <https://doi.org/10.1109/TSG.2017.2679238>.
- [9] K. Turitsyn, P. Sulc, S. Backhaus, M. Chertkov, Options for control of reactive power by distributed photovoltaic generators, Proc. IEEE 99 (6) (2011) 1063–1073, <https://doi.org/10.1109/JPROC.2011.2116750>.
- [10] F. Najibi, D. Apostolopoulou, E. Alonso, TSO-DSO coordination schemes to facilitate distributed resources integration, Sustainability 13 (4) (2021).
- [11] J. Zhao, H. Wang, Y. Liu, Q. Wu, Z. Wang, Y. Liu, Coordinated restoration of transmission and distribution system using decentralized scheme, IEEE Trans. Power Syst. 34 (5) (2019) 3428–3442.
- [12] A. Alkandari, A.A. Sami, A. Sami, Proposed DSO ancillary service processes considering smart grid requirements, in: 24th International Conference & Exhibition on Electricity Distribution (CIRED) 2017, 2017, pp. 2846–2847.
- [13] ENTSO-E, “Reactive Power Management At T – D Interface: ENTSO-E guidance document for national implementation for network codes on grid connection.” ENTSO-E, 2016.
- [14] H. Gerard, E.I. Rivero Puente, D. Six, E.I.R. Puente, D. Six, Coordination between transmission and distribution system operators in the electricity sector: a conceptual framework, Util. Policy 50 (2018) 40–48, <https://doi.org/10.1016/j.jup.2017.09.011>.
- [15] H. Hooshyar, L. Vanfretti, A SGAM-based architecture for synchrophasor applications facilitating TSO/DSO interactions, in: 2017 IEEE Power & Energy Society Innovative Smart Grid Technologies Conference (ISGT), 2017, pp. 1–5.
- [16] E. Lambert, et al., Practices and architectures for TSO-DSO data exchange: european landscape, in: 2018 IEEE PES Innovative Smart Grid Technologies Conference Europe (ISGT-Europe), 2018.
- [17] A. Saint-Pierre, P. Mancarella, Active distribution system management: a dual-horizon scheduling framework for DSO/TSO interface under uncertainty, IEEE Trans. Smart Grid 8 (5) (2017) 2186–2197, <https://doi.org/10.1109/TSG.2016.2518084>.
- [18] D.A. Sbordone, E.M. Carlini, B. Di Pietra, M. Devetsikiotis, The future interaction between virtual aggregator-TSO-DSO to increase DG penetration, in: 2015 International Conference on Smart Grid and Clean Energy Technologies (ICSGCE), 2015, pp. 201–205.
- [19] N. Silva, A. Maia Bernardo, R. Pestana, C. Mota Pinto, A. Carrapatoso, S. Dias, Interaction between DSO and TSO to increase DG penetration - the Portuguese example. CIRED 2012 Workshop: Integration of Renewables into the Distribution Grid, 2012, pp. 1–4, <https://doi.org/10.1049/cp.2012.0885>.
- [20] A. Vicente-Pastor, J. Nieto-Martin, D.W. Bunn, A. Laur, Evaluation of flexibility markets for retailer-dso-tso coordination, IEEE Trans. Power Syst. 34 (3) (2019) 2003–2012, <https://doi.org/10.1109/TPWRS.2018.2880123>.
- [21] TDX-ASSIST Project, “Deliverable D1.1, state of the art - TSO-DSO interoperability,” Horizon 2020, the EU Framework Programme for Research & Innovation, 2017.
- [22] L. Osterlund, Under the hood. An overview of the common information model data exchanges, IEEE power&energy Mag 1 (2016) 68–82.
- [23] A. Souvent, A. Kodek, A. Suljanović, CIM-based integration in smart grids: slovenian use cases, in: 18th International Symposium INFOTEH-JAHORINA, 2019.
- [24] M. Usilar, M. Specht, S. Rohjans, J. Trefke, J.M. González, The Common Information Model CIM: IEC 61968/61970 and 62325 - A practical Introduction to the CIM, Springer, 2012.
- [25] M. Gottschalk, M. Usilar, C. Delfs, The Use Case and Smart Grid Architecture Model Approach: The IEC 62559-2 Use Case Template and the SGAM Applied in Various Domains, Springer, 2017.
- [26] C. Madina, et al., Technologies and protocols: the experience of the three SmartNet pilots. TSO-DSO Interactions and Ancillary Services in Electricity Transmission and Distribution Networks, Springer, 2020, pp. 141–183.
- [27] O. Lysorn, S. Sangwongwanich, A voltage rise mitigation strategy under voltage unbalance for a grid-connected photovoltaic system, Procedia Comput. Sci. 86 (Dec. 2016) 309–312, <https://doi.org/10.1016/j.procs.2016.05.084>.
- [28] K.H. Chua, J. Wong, Y.S. Lim, P. Taylor, E. Morris, S. Morris, Mitigation of voltage unbalance in low voltage distribution network with high level of photovoltaic system, Energy Procedia 12 (2011) 495–501, <https://doi.org/10.1016/j.egypro.2011.10.066>.
- [29] D. Çelik, M. Meral, Voltage support control strategy of grid connected inverter system under unbalanced grid faults to meet fault ride through requirements, IET Gener. Transm. Distrib. 14 (Aug. 2020), <https://doi.org/10.1049/iet-gtd.2019.1206>.
- [30] V.S.S. Kumar, K.K. Reddy, D. Thukaram, Coordination of reactive power in grid-connected wind farms for voltage stability enhancement, IEEE Trans. Power Syst. 29 (5) (2014) 2381–2390, <https://doi.org/10.1109/TPWRS.2014.2300157>.
- [31] A. Bachoumis, C. Kaskouras, and M.C. Sousounis, TSO/DSO coordination for voltage regulation on transmission level: a greek case study. 2021.
- [32] C. Edmunds, S. Galloway, I. Elders, W. Bush, R. Telford, Design of a DSO-TSO balancing market coordination scheme for decentralised energy, IET Gener. Transm. Distrib. 14 (Mar. 2020), <https://doi.org/10.1049/iet-gtd.2019.0865>.
- [33] G. Taylor, E. Marjan Radi, F. Lambert, and M.U. less Marten, “Design and development of enhanced data exchange to enable future TSO-DSO interoperability,” 2019.
- [34] N. Suljanović, et al., Design of interoperable communication architecture for TSO-DSO data exchange, in: 2019 IEEE Milan PowerTech, 2019, pp. 1–6, <https://doi.org/10.1109/PTC.2019.8810941>.
- [35] M. Radi, G. Taylor, M. Usilar, J. Köhlke, N. Suljanovic, Bidirectional power and data flow via enhanced portal based TSO-DSO coordination, in: 2019 54th International Universities Power Engineering Conference (UPEC), 2019, pp. 1–5, <https://doi.org/10.1109/UPEC.2019.8893602>.
- [36] EDF, “Modsrans user guide,” EDF, 2013.
- [37] G. Migliavacca, et al., SmartNet: H2020 project analysing TSO-DSO interaction to enable ancillary services provision from distribution networks, CIRED-Open Access Proc. J. 2017 (1) (2017) 1998–2002.

- [38] N. Natale, F. Pilo, G. Pisano, G.G. Soma, Scheduled profile at TSO/DSO interface for reducing balancing costs, in: 2019 1st International Conference on Energy Transition in the Mediterranean Area (SyNERGY MED), 2019, pp. 1–6.
- [39] M. Uslar, et al., Applying the smart grid architecture model for designing and validating system-of-systems in the power and energy domain: a European perspective, *Energies* 12 (2) (2019) 258.
- [40] L. Vanfretti, H. Hooshyar, R.S. Singh, A. Bidadfar, F. Mahmood, Synchrophasor applications for distribution networks, supporting the IDE4L use case, *IEEE Power Energy Soc. Gen. Meet.* (2017).
- [41] F.B. Araujo, R.B. Prada, Distributed generation: voltage stability analysis, in: 2013 IEEE Grenoble Conference, 2013, pp. 1–4, <https://doi.org/10.1109/PTC.2013.6652097>.
- [42] M.D. McDonald, R.A. Walling, R. D'Aquila, J.G. Cleary, Effect of distributed generation on regional voltage stability. *PES T&D 2012*, 2012, pp. 1–6, <https://doi.org/10.1109/TDC.2012.6281647>.
- [43] V. Astapov, P.H. Divshali, L. Söder, The potential of distribution grid as an alternative source for reactive power control in transmission grid, in: 2018 19th International Scientific Conference on Electric Power Engineering (EPE), 2018, pp. 1–6, <https://doi.org/10.1109/EPE.2018.8396031>.
- [44] M. Marchesoni, A. Marinopoulos, S. Massucco, and V. Picco, *High penetration of very large scale PV Systems into the European electric network*. 2012.
- [45] E. Srilakshmi, S.P. Singh, Effect of distributed generation on secondary level transmission system, in: 2017 4th International Conference on Power, Control & Embedded Systems (ICPCES, 2017, pp. 1–4, <https://doi.org/10.1109/ICPCES.2017.8117637>.