

Received September 10, 2020, accepted September 25, 2020, date of publication September 29, 2020, date of current version October 9, 2020.

Digital Object Identifier 10.1109/ACCESS.2020.3027640

Dynamic Modeling and Heat Flow Study of a Thermal Power Plant Using OpenModelica

HAFEEZ ANJUM^{1,2}, AZHAR UL-HAQ¹, AND IMRAN MAHMOOD², (Member, IEEE)

¹Department of Electrical Engineering, College of Electrical and Mechanical Engineering, National University of Sciences and Technology (NUST), Islamabad 44000, Pakistan

²Center for Research in Modeling and Simulation (CRIMSON), School of Electrical Engineering and Computer Science (SECS), National University of Sciences and Technology (NUST), Islamabad 44000, Pakistan

Corresponding author: Azhar Ul-Haq (azhar.ulhaq@ceme.nust.edu.pk)

ABSTRACT With the integration of intermittent energy sources in the power system, the main focus of thermal power plant design is to optimize the conventional system by improving efficiency and flexibility of power generation in the start-up and base-load procedures. This paper focuses on the behavior of thermal power generation with respect to load variations, fuel variations, weather conditions and internal dynamics of the system to aid in energy planning and the optimization of power system. Dynamic modeling and subsequent simulation is to make improvements. Therefore, to model the system, this research study has used a dynamic modeling and a simulation framework (OpenModelica based on modelica language) which is an object-oriented and equation-based language. This framework allows a non-causal modeling and a flexible reuse of the models since data-flow direction is not predefined like other state of the art simulating tools i.e. MATLAB. The proposed model analyses the trend of electrical power generation of KOT ADDU thermal power plant to predict the future demand of electrical power. The achieved results show more than 90% accuracy of the proposed model in the transient operation such as start-up and base load procedure.

INDEX TERMS Thermal power plant simulation, dynamic modeling, OpenModelica, optimization of thermal plant.

I. INTRODUCTION

Modern world's electrical power system consists of different energy sources which includes Thermal energy, Nuclear energy, Hydro energy and Renewable energies. According to [1], the thermal generation is inevitably diminishing with the integration of variable electrical power generations like solar electrical power generation and wind electrical power generation in the electrical power system. According to [2], environmental concerns due to the emission of hazardous gas is also putting the thermal power generation under a severe pressure but still a large amount of electrical power generation of Pakistan relies on fossil fuels, accounting more than 60 percent of the total electrical power generation [3].

With the integration of renewable energies into the power system, significant energy fluctuations are being faced in the global energy markets. For the stability of the power system these fluctuations need to be considered and addressed. These

The associate editor coordinating the review of this manuscript and approving it for publication was Yang Han ¹.

changes brought new challenges in the power system which can be solved with system simulations [4], [5]. System simulation aid in energy planning which plays an important part in the modern electrical system. Energy planning helps relevant authorities to make sure the best possible and optimal generation and consumption of electrical power [20]. Conventional electrical power system was somehow a predictable system due to its linearity but with the integration of intermittent energy sources, the modern electrical system has become very complex due to fluctuations. To avoid such complications and to meet the electricity's demand, the electrical power system needs to have a dynamic model which can foresee the future electricity's demand with respect to different variables like loads, weather conditions, fuels and internal dynamics of the system. A model is an important tool for monitoring, performance assessment, control design, fault detection and optimization of the system [6]. The challenge of modeling real-world complex systems can be explained with the following attributes of the complex system: [21]

* A complex system is a combination of multiple sub-systems or units.

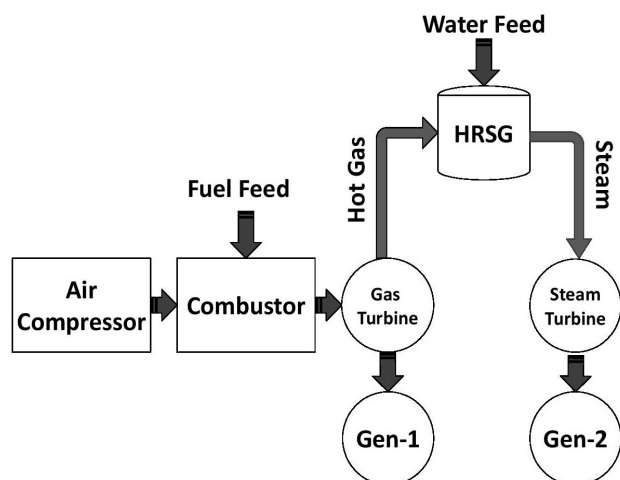

FIGURE 1. Illustration of a Combined cycle power plant.

* These units are related to each other and the output or operation of every unit depends on the operation of other units.

* Combined effects produced by the units may either be desirable or undesirable and can not easily be foreseen.

A. MODELING AND SIMULATION OF THERMAL POWER PLANTS

This research work focuses on the modeling and simulation of Thermal power plant to optimize the operation of thermal electrical power system. Modern simulation programs allow a rapid assessment of [7];

* Operating behaviour of plant during transients.

* Optimization of plant.

* Maintenance of plant.

* Control and design of new plant.

Although gas turbine power system is a stable form of electrical energy but the problem comes with the efficiency of the system which is very low. Typical gas turbine efficiencies are between 20 to 25 percent and different hazardous gases like CO₂ and NO_x are exhausted into the atmosphere, so there has always been a focus on the improvement of the efficiencies of thermal systems [8]. This endeavor brought us to a new technology in the thermal system known as CCPP (combined cycle power plant) [9]. CCPP has a flexible layout, usually consists of one or two gas turbines that generate electricity through electrical generators and exhaust the hot gases into the HRSG (heat recovery steam generator) that converts the water coming from the water tanks into steam for a Rankine cycle system [9]. This highly pressurized and high temperature steam drives steam turbine and generates electricity through electrical generator. The thermal efficiency of the CCPP can be as high as 52 percent and that is the main reason for the popularity of the CCPP. Another reason for the popularity of the CCPP is that it can be built in less time than the typical thermal system of the same output.

A thermal electrical power system is a combination of multiple domains like Electrical, thermodynamics and mechanical domain. A mechanical domain includes pumps, valves and pipe elements while electrical domain includes generators, lines, circuit breakers and motor etc. A thermodynamic domain involves the compression of air in the compressor and expansion of hot flu gas in the turbine [9], [10]. A system is usually modeled focusing on one of these domains. In this research work we are focusing on the electrical domain of the system as well as thermodynamic domain [11]. This research work used KAPCO (KOT ADDU power company, muzaffargarh, Pakistan)¹ thermal power plant as case study for the validation of the proposed model. KAPCO Thermal Power Plant is the largest IPP (independent power producer) of Pakistan with the capacity of 1600MW. KAPCO is a Combined Cycle Power Plant including 10 multi-fuel Gas turbines and 5 steam turbines. In the proposed model we will only consider one combination of two gas turbines and a steam turbine as it is a multi-shift power plant [9]. Below described are the contributions of this research work in the field of Thermal Power System;

1. The proposed model assesses the operating behaviour of the thermal power plant by monitoring the power system and controlling with the help of dynamic modeling. The proposed dynamic model of the KAPCO thermal power plant focuses on the optimization of the system.

2. A complete and an explicit model of gas turbine and water/steam cycle is presented using component-based approach. Components like air-compressor, combustion chamber, fuel consumption, feed water sources, water tanks, pipes, electrical Pumps and controls valves are modeled in detail taking into account the real data collected. A complete rankine cycle of both parallel heat recovery steam generators are modeled containing evaporators, economisers and superheaters. The proposed model covers 60 percent procedure of electrical power generation through steam system.

3. The proposed model simulates for the first 18.6 minutes of the start-up of thermal power plant. So, the presented model shows the simulation for the 100 percent of the electrical power generation of Gas power system as gas system reaches to 100 percent electrical power generation within 20 minutes. The achieved simulated results from gas turbine systems indicate accuracy of the model in the start-up and base-load procedures for gas turbine system.

4. The novelty of the proposed model is that it models the internal electrical power consumption of the electrical pumps, air compressor etc. For simplicity, electrical generator is modeled as a common electrical power generating machine for all the gas and stodola turbines to get a simulated result for an overall electrical power produced.

5. Total heating surface area is distributed among boiler's components in the proposed model according to the real data collected from KAPCO thermal power plant. This heating

¹ KAPCO is a public limited Pakistani power company owns, operates, and maintains a multi-fuel fired power plant(30°26'43.1"N 70°58'48.0"E).

TABLE 1. Literature survey, identification of research gaps and a comparison of proposed model's features.

Research Work	Proposed Methodology	Contribution	Research Gaps	Internal power consumption	Valves/Pumps	Water/Steam Cycle	HRSG
[4]	Developed a controller for rankine cycle with Modelica using ClaRa library	Solved complex power plant simulation tasks by developing controller to reduce internal power consumption.	This study does not involve a Combined cycle power plant but considers only the rankine plant.	×	✓	✓	×
[8]	A model-based control scheme with Modelica using ClaRaCSS library	A control scheme for a Rankine cycle to capture CO2 is presented.	Basic components of a rankine cycle are not considered.Simplified by capturing only the pre-heater storage capacities.	×	×	✓	×
[11]	Thermal plant modeling with Dymola software	A Thermal plant is modeled with the frequency control method through a speed governor.	A simplified model is considered.Gas and steam cycle components like tanks and compressor were not modeled in detail.	×	×	✓	×
[12]	Modeling of a Rankine Cycle with Modelica using Thermocycle library	Mass flow rate is controlled using PID controller to vary the speed of water pumps.	Simulation does not focus on the results as parameters are selected hypothetically.	×	✓	✓	✓
[13]	A linear mathematical model of thermal power plant for heat load dispatch	Linear programming distribution is used for the optimization of plant by reducing energy consumption.	The model for thermal power plant was not considered and modeled in detail to give a better picture of the study.	×	✓	✓	✓
[14]	A mathematical model for the control design of CSP	Permits a control design to potentially enhance the life and generation cost reduction of solar system integrated with thermal power plant.	Demand forecast model does not include the details of pipes, water storage and other basic steam system components	×	✓	✓	✓
[15]	Dynamic modeling of a thermal power station with modelica	A closed cycle from condenser to main water tank is developed for 100 percent load of a thermal power plant.	The model is not validated with experimental data and mass flow rate is not realistic as flow multiplier are used multiple times.	✓	✓	×	✓
[10]	A mathematical approach to compute dynamic model parameters of a steam turbine	incorporated the effects of variations of steam turbine's parameters in the dynamic performance of automatic generation control system of a thermal power plant.	The model presented is a generalized model and is not validated with any source information. A detailed modeling of thermal plant would have given a better picture of the AGC control.	×	×	✓	✓
[16]	Energy Management System for monitoring and reporting energy data is proposed for the flexible operation of a Thermal power station	Unlike TES-only technologies this study proposed steam storing scheme into thermal tanks during peak-off load to be used as secondary thermal power when needed.	A very simplified model of rankine cycle is considered. A detailed consideration may give us more realistic results of rankine cycle's TES system.	×	✓	✓	×
Proposed work	A dynamic model for a thermal power plant is presented using Modelica	Solved complex combined cycle thermal power plant problems with a detailed dynamic components-based modeling.	The proposed model does not cover 100 percent electrical power generation through steam system.	✓	✓	✓	✓

surface can be changed in the proposed model to model any thermal plant with different heating surface area.

6. The simulated results are validated with the real data that indicates more than 90% accuracy of the proposed model which may help the energy planners to predict the future demand of the thermal power generation whether for the purpose of the flexible power system or for the base-load consumption. Various research works have been published that focus on the modeling and control design of Brayton cycle, Rankine cycle or CCPP using different techniques.

Some of these studies, their proposed techniques and model's features are explained and compared in table 1. From the table it can be observed that the proposed model is representing a modern thermal power plant as most of the research works either consider brayton or rankine thermal power systems but only few model CCPP. The proposed model covers almost all sub-components of combined cycle power plant including electric pumps, control valves, boiler and plant's internal power consumption in detail. In the pursuit of achieving more efficient thermal power system, CCPP is being preferred and

adopted. Therefore, this research study may contribute its part in the work of optimizing the electric power industry.

II. METHODOLOGY

CCPP is a complex and a dynamic electrical system. To model this system this research work proposed a dynamic modeling framework named as OpenModelica software (<https://build.openmodelica.org/omc/builds/windows/releases/1.14/1/>). This is an open source software available on openmodelica's website for free of cost. This is an object-oriented, equations-based modeling tool containing more than a hundred inbuilt libraries and a well number of external libraries that can be downloaded from github website [8]. This tool combines a graphical user interface with the model and is useful in modeling complex physical systems with mechanical, electrical and control sub-components [7].

The proposed model used an in-built library ThermoSyspro which represents thermal systems and contains all the basic components of thermal systems [15]. This library contains components like dynamics and static water tanks, different water pumps, dynamic and static heat ex-changers, gas turbine, steam turbine, air-compressor, combustor and other important thermal system's components. This research work proposed a components-based model of CCPP that includes dynamic in-built models of all its components from the ThermoSyspro library. A complete water/steam cycle is presented and modeled along with the gas turbine cycle. Design parameters for every component in the proposed model are selected considering the behavior and output of the related component on hit and trial basis. Models for brayton cycle, rankine cycle and combined cycle are proposed in this research work. The overall proposed model contains three components on the basis of their colour. Yellow components are representing static modeling, green components show both static and dynamic modeling while blue components are used for dynamic modeling only.

III. SYSTEM MODEL

A components-based model was developed and simulated with Openmodelica which automatically generates equations of the developed model on the background. The proposed model is a combination of three sub-models such as brayton cycle, rankine cycle and a combined cycle model.

A. MATHEMATICAL MODEL

For the power plant's proposal stage, dynamic simulation is useful and preferred. Complex differential equations and other numerical methods have made dynamic simulation very sophisticated and user friendly. However, mathematical models play an important role for increasing flexibility and efficiency of power plants by providing a better understanding of the process and their capabilities [7]. According to [9], The difference between the compressor internal power consumption and gas turbine power is actually the output

power of gas turbine which can be computed using eq.(1),

$$W = \frac{P_G \cdot K_0}{T_f(1 - \frac{1}{X})\eta_T - T_i(\frac{X-1}{\eta_c})} \quad (1)$$

where;

$$K_0 = \frac{KW_0 \cdot 3413}{W_0 \cdot T_{f_0} \cdot c_P} \quad (2)$$

W is the air flow in p.u and KW_0 is the base net output in p.u.

Where;

W_0 = Air flow in p.u initially

T_{f_0} = Turbine inlet temperature at initial in p.u

c_P = Average specific heat at a constant pressure

T_f = Gas turbine inlet temperature

T_i = Compressor inlet temperature in p.u

η_c = Compressor efficiency

η_T = Turbine efficiency

X = Gas turbine inlet pressure to ambient pressure and is computed by eq.(3),

$$X = P_R \left(\frac{\gamma - 1}{\gamma} \right) \quad (3)$$

where;

$$\gamma = \frac{c_P}{c_V} \quad (4)$$

where;

c_P = Average specific heat at a constant pressure

c_V = Average specific heat at a constant volume

While;

$$P_G = P_{M_G} \cdot W \quad (5)$$

where;

P_{M_G} = Mechanical power of the turbine Gas turbine inlet temperature can be computed using eq.(6),

$$T_f = T_{C_D} + \frac{W_f K_2}{W} \quad (6)$$

where;

T_{C_D} = Compressor discharge temperature in p.u

W_f = Fuel flow in p.u

Now putting the value of W from eq.(1) into eq.(6) to find T_f , we have

$$T_f = T_i \left(1 + \frac{X-1}{\eta_c} \right) + \frac{W_f K_2}{W} \quad (7)$$

where, K_2 is the design combustor temperature rise in p.u that is represented with eq.(8),

$$K_2 = \frac{\Delta T_0}{T_{f_0}} \quad (8)$$

where;

ΔT_0 = Temperature change in an ideal compressor cycle

The exhaust temperature of the Gas turbine can also be computed with the eq.(9),

$$T_E = T_f \left[1 - \left(1 - \frac{-1}{X} \right) \eta_T \right] \quad (9)$$

The exhaust mass flow W and the exhaust temperature T_E from the Gas turbine actually decide the value of heat transfer to the heat recovery steam generator of steam system.

In an ideal compressor, the temperature change is $(T_{02}-T_{01})$ while in real cycle the temperature change is $(T'_{02}-T_{01})$. The efficiency of the compressor can be computed with the eq.(10),

$$\eta_C = \frac{C_P \Delta T'_0}{C_P \Delta T_0} = \frac{T'_{02} - T_{01}}{T_{02} - T_{01}} \quad (10)$$

where;

C_P = Mean heat capacity of the gas

T'_0 = Real temperature

T_0 = Ideal temperature

mean Heat capacity (C_P) is a product of specific heat (c_p) and the mass (m) of a substance.

eq.(10) can be written into,

$$T_{02} - T_{01} = \frac{1}{\eta_C} \Delta T'_0 \quad (11)$$

eq.(11) can be further developed into

$$T_{02} - T_{01} = \frac{T_{01}}{\eta_C} \left(\frac{T'_{02}}{T_{01}} - 1 \right) \quad (12)$$

As we know that the change in pressure ratio of the cycle is proportional to the change in temperature ratio of the cycle so, we can write it as;

$$T_{02} - T_{01} = \frac{T_{01}}{\eta_C} \left[\left(\frac{P_{02}}{P_{01}} \right)^{\frac{\gamma-1}{\gamma}} - 1 \right] \quad (13)$$

where;

P_{02} = Compressor outlet pressure

P_{01} = Compressor inlet pressure

As we know that X is the ratio of gas turbine inlet pressure to ambient pressure and if we assume that the compressor is ideal, so, there would not be any pressure loss and then the compressor outlet pressure will be the same as the gas turbine inlet pressure. So, we can replace the pressure ratio from eq.(13) with X from eq.(3),

$$T_{02} = T_{01} + \frac{T_{01}}{\eta_C} (X - 1) \quad (14)$$

Using eq.(14), we can compute the compressor output temperature. According to [9], the active power of the high pressure steam turbine and low pressure steam turbine may be computed with the eq.(15),

$$KW_g = \frac{m_{HP} E_{HP} + m_{LP} E_{LP}}{3413} \quad (15)$$

where;

E_{HP} = HP steam turbine actual energy

E_{LP} = LP steam turbine actual energy

m_{HP} = Steam flow through HP steam turbine

m_{LP} = Steam flow through LP steam turbine

Now to compute m_{HP} and m_{LP} we can use the following equations,

$$m_{HP} = K_T . P_{HP} \quad (16)$$

$$m_{LP} = m_{HP} + K' . P_{LP} \quad (17)$$

where;

K_T = Throttle value flow coefficient

K' = Admission point flow coefficient

P_{HP} = HP steam turbine pressure

P_{LP} = LP steam turbine pressure

With eq.(16) and eq.(17), the flow rate of steam through the HP steam turbine and LP steam turbine can be calculated.

B. BRAYTON CYCLE

The air is drawn into the compressor, increasing the pressure up to 11 bars and temperature may be as high as 350 degC and that compressed air is used in the combustor where combustion takes place. Hot flue gases are produced in the combustion process and these hot flue gases are used to drive gas turbines by giving the thermal energy to the steam turbine's blades. Thus, converting the thermal energy of hot gases into mechanical energy in the process of expanding the gases in the turbine section. The exhausted hot gases at the output of the gas turbine have temperature around 550 degC and are exhausted into the atmosphere. This process is called as Brayton Cycle and can be represented on a temperature-enthalpy diagram. Brayton Cycle is illustrated in the Fig.2 and the proposed Modelica's model for the brayton cycle is shown in Fig.3. The area under the curve is the amount of heat required to make a gas thermal process to occur.

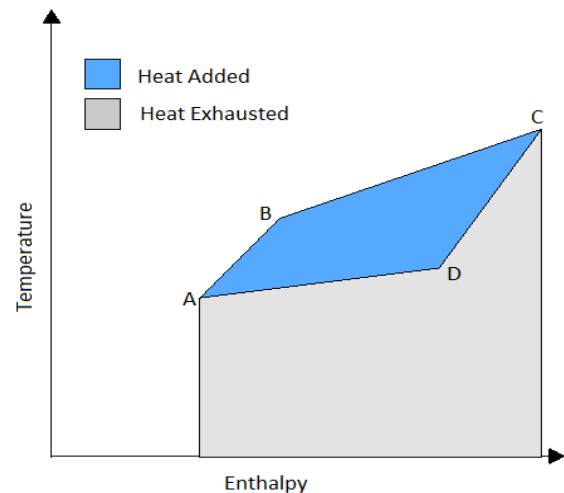

FIGURE 2. T-h diagram for the Brayton Cycle.

The line A-B represents the first process of compression of the air in the compressor. In compression, the air stores the energy in the form of temperature and pressure. This process is known as isentropic compression [9]. The line B-C represents the burning of fuel in the combustion chamber and an additional heat is added to the cycle at a constant pressure. This process is called as constant pressure heat addition [9]. The line C-D represents the expansion of hot gas while passing through the gas turbine and the energy of the

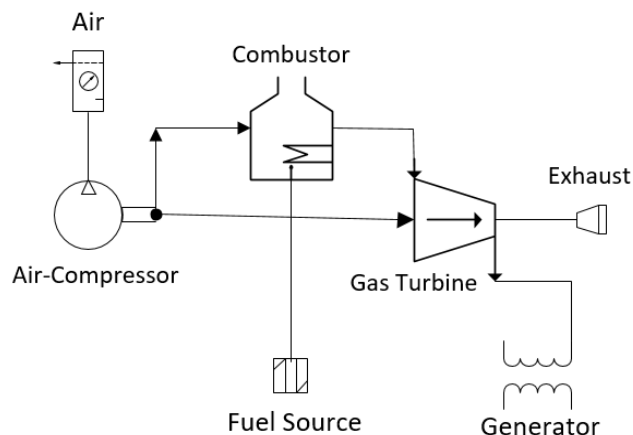

FIGURE 3. Proposed model for the Brayton Cycle.

hot pressurized gas is utilized to move the blades of the gas turbine. This process is called as isentropics expansion [9]. The line D-A is the final process of brayton cycle in which the hot gas is exhausted to the atmosphere and decreases its temperature. This process is called as constant pressure heat rejection [9]. The area under the line D-A represents the heat that is wasted while the area between the line B-C and D-A is the heat that is converted to useful mechanical energy which is approximately 20 percent of the total heat required to make Brayton process work. The proposed model for the brayton cycle is shown in Fig.3 which includes the air compressor, combustion chamber and the gas turbine.

In Fig.3 we can see that after the expansion of hot gas in gas turbine, the gas is not used further and is being exhausted into the air. In this process the gas with a useful thermal energy is being wasted into the air, due to which the efficiency of this system is about 20 to 25 percent. The speed of gas turbine or load variations can be controlled by flow rate of fuel and air intake. For a peak load the quantity of fuel and air intake is increased and is decreased for the base load. Variations in fuel type also makes a notable impact on the efficiency of thermal power system. The efficiency of thermal power system is 32 percent on gas, 31 percent on HSD and 30 percent on oil. A humidity factor is added with the modelica sub-model of air source. This humidity factor varies with the weather condition as it involves the parameters of H₂O density, mass fraction of O₂, air density and vapor saturation pressure in the atmosphere. Atmospheric pressure and temperature also affect the power plant’s performance that are considered in the proposed model.

C. RANKINE CYCLE

A Rankine Cycle includes a boiler which consists of heat ex-changers to convert the water coming from the feed pumps into the steam and a steam turbine is connected at the end of the boiler [9]. The steam coming out of steam generator drives the blades of the steam turbine by expanding and cooling of steam as it passes through the turbine, thus converting the

momentum(kinetic energy) into mechanical energy [10].The Rankine Cycle is represented in a temperature-enthalpy diagram in Fig.4.

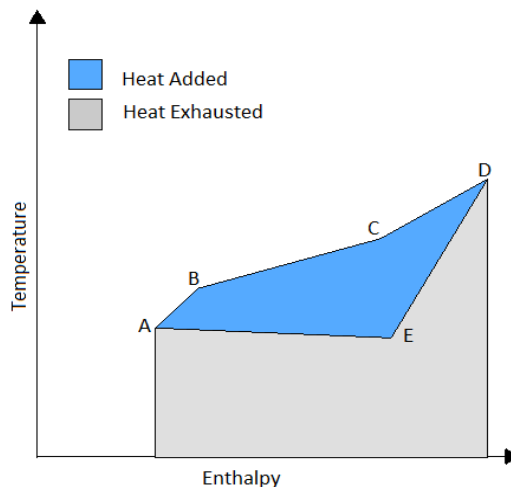

FIGURE 4. T-h diagram for the Rankine Cycle.

The line A-B represents the heat that is added when the feed water pumps increase the pressure of water as well as slightly increase in the enthalpy before entering into the boiler. The line B-C shows the heat that is added to the water entering the boiler. The water is converted into steam at a constant pressure within the boiler.

The line C-D shows the further addition of heat into the steam while it passes through the super-heater of the boiler. The line D-E and E-A are representing the heat lost during the expansion and cooling of steam as it passes through the turbine and in the process of steam condensation.

Fig.5 represents a proposed model for a Rankine Cycle. A constant amount of water is fed to the main water tank. Two water pumps are connected at the output of the main water tank to increase the pressure of the water. Low pressure water tank is connected with the low pressure evaporator to circulate the water to maintain a specific temperature in the tank. While the High pressure water tank is connected with the high pressure evaporator after the economiser. Super-heater at the end of the boiler used as a steam dryer and to further increase the steam temperature.It is important to keep the temperature of the HRSG within a limit otherwise it may cause deformation and material cracks [17]. This high pressure and high temperature steam drives the blades of the turbine and generates electricity. The mechanical energy of the steam turbine can be controlled with the steam flow rate through it and the exhausted hot gas from gas turbine [10].

D. COMBINED CYCLE POWER PLANT

KAPCO’s Combined Cycle power plant is a combinatin of two gas turbines and one steam turbine. The hot flu gas that was being exhausted to the air before, will now be utilized for the generation of steam in the boiler. CCGP has improved the

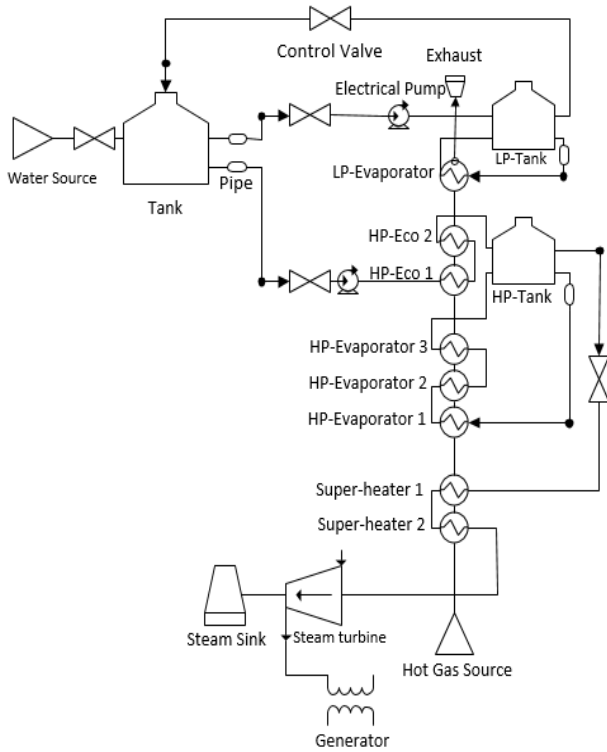

FIGURE 5. Proposed model for the Rankine Cycle.

efficiency of the thermal system by approximately two times because most of the added heat will now be used for the CCPP process to work.

To explain it in more details the temperature-enthalpy diagram can be used for the purpose. Fig.6 is representing the useful heat and the wasted heat of the CCPP. The upper area is representing the Brayton Cycle while the lower useful area is representing the Rankine Cycle. We can see that the area enclosed by the rankine cycle is within the area of the heat rejected from the Brayton Cycle. Therefore, in CCPP the Rankine Cycle is actually utilizing the heat energy from the Brayton Cycle that would other-wise be exhausted to the

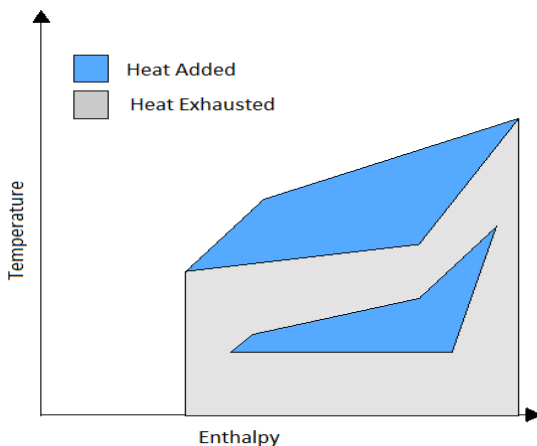

FIGURE 6. T-h diagram for the CCPP.

atmosphere. This technology has improved the efficiency of the thermal power system as a large amount of heat is added in CCPP as compare to Brayton or Rankine cycle. CCPP does not only improve the efficiency of the thermal power system but also helps in reducing the industrial pollution by reducing the emission of different hazardous gases as well. CCPP is more stable and has better reliability than the conventional Rankine and Brayton Cycle.

A proposed dynamic model for the Combined Cycle Power plant of KAPCO is shown in Fig.7. In dynamic modeling the current output of the model depends on the previous value of the output of the same model [18], [19]. The proposed model contains many components that contribute in the flow of water/steam in the rankine cycle and flow of hot gas in the brayton cycle. The contributions of these components in the flow of model are explained as follows;

- 1-**Air-compressor** that takes in the air from surroundings and increases the air pressure from 1 bar to 13 bars and temperature up-to 400 degC.
- 2-**Combustion section** uses fuel from the fuel source and compressed air from the air-compressor for the combustion process and produces hot gases with temperature up-to 1100 degC. The mass flow rate through air-compressor is 445kg/s.
- 3-**Fuel source** provides fuel for the combustion process following a ramp signal up-to 9.3kg/s.
- 4-**Gas turbine's** blades are driven by the hot gases from combustions section converting the thermal energy of hot gas into mechanical energy. The exhausted gas from gas turbine has temperature around 560 degC and enters super-heater of HRSG.
- 5-**Electrical generator** is coupled with the gas turbine and generates electrical power.
- 6-**Water source** provides water with flow rate of 76kg/s without interruption to the main water tank.
- 7-**Main water tank** stores water for the water/steam cycle.
- 8-**Pipe** assures a stable amount of water or steam flow.
- 9-**LP-electrical pump** increases the pressure of water from 3.6 bars to 7.1 bars before water enters the LP water tank.
- 10-**LP-water tank** circulates the water back to main water tank to maintain a specific temperature of main water tank using LP-evaporator of HRSG.
- 11-**LP-evaporator** increases the temperature of circulating water in the LP-water tank.
- 12-**Control valve** controls the flow rate of water and steam.
- 13-**HP-electrical pump** Increases the pressure of water to 60 bars before water enters HP-economiser.
- 14-**HP-economiser** has two stages and increases the temperature of high pressurized water to more than 200 degC before HP-water tank.
- 15-**HP-water tank** circulates high pressurized and high temperature water to increase temperature with HP-evaporator to convert water into saturated form.

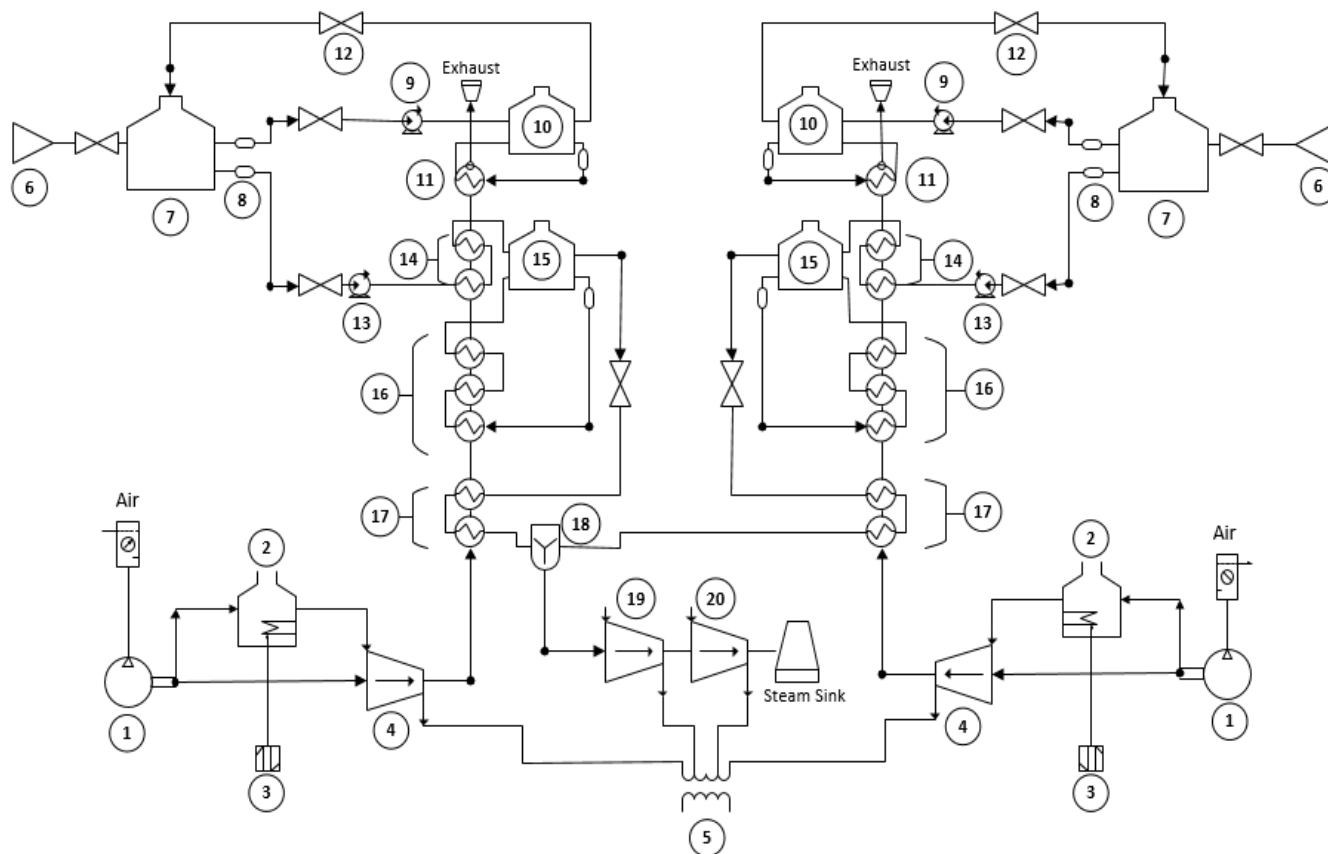

FIGURE 7. Proposed model for the CCPP.

16-HP-evaporator has three stages that give more enthalpy to the circulating saturated water up-to 2000kj/kgdegC.

17-Super-heater contains two stages that converts the saturated steam into super-heated steam and also works as steam dryer. The number of tubes in each heat exchanger of the proposed model is divided according to the heating area of case study.

18-Steam mixer is used to mix both steams from two parallel HRSGs without losing pressure and temperature.

19-HP-steam turbine's blades are driven by super-heated steam by converting the kinetic energy into mechanical energy.

20-LP-steam turbine uses a low pressurized steam to move its blades. Both steam turbines are coupled with the electrical generator to generate electrical power.

IV. CASE STUDY

To validate the proposed model, KAPCO (Kot Addu Power Company) thermal power plant, muzafargarh, Punjab, Pakistan is used as case study. KAPCO thermal power plant contributes 6 percent in the total Pakistan's electricity generation. It is the largest combined cycle power plant of Pakistan containing 10 multi-fuel gas turbines and 5 steam turbines.

In KAPCO, two gas turbines generate electricity and then exhaust their hot gases to two parallel HRSGs.

Steam is produced within HRSGs and then this high pressurized and high temperature steam from both HRSGs drives a single steam turbine to generate more electrical power. Gas, furnace oil and HSD are used as fuels for the combustion process of the gas turbine system. Total heating surface area for HRSG of KAPCO is 84000 square metres which is divided into 11 percent area for LP-Evaporator, 40 percent for HP-Economiser, 42 percent for HP-Evaporator and 7 percent for HP Super-heater. Every turbine is coupled with a separate electrical generator but for the purpose of developing a model to be generic in nature, the proposed model simplified the generator's model by considering and modeling only a single generator. Some important and relevant data of KAPCO thermal power plant are shown in the table 2 and table 3.

V. SIMULATION RESULTS

A. GAS TURBINE-1

The gas turbine-1 system of KAPCO starts generating electrical power in 2 to 3 minutes after air compressor and the combustion chamber start working, but for generalization of the model we simulated the electricity generation at the same time as air compressor and combustion chamber start working

TABLE 2. KAPCO plant data for gas turbine.

S.No.	Description	Data Values
1	Manufacturer	Siemens, Germany
2	Base-Load Rating	110 on Gas 106 on HSD 106 on Fuel oil
3	Starting Device	S.F.C generator runs as motor initially
4	Starting time up-to 3000rpm	4 minutes
5	Turbine inlet temperature	1050 degC
6	Turbine exhaust temperature	530 degC to 550 degC
7	Spining Reserve	21 minutes
8	Auto Loading Gradient	11MW/minute upto base-load
9	Compressor Stages	17
10	Compressor Ratio	10
11	No. of Combustors	2
12	Average Overall Efficiency	32 percent on GAS 31 percent on HSD 30 percent on BFO
13	No. of Stages	4
14	Maximum Mass Flow through Turbine	406 kg/s
15	Declutching Speed	2100 to 2300 RPM

because our main objective is to develop a general thermal power plant model while KAPCO plant is used as case study for the purpose.

In Fig.8, the real data curve line and simulated curve line for the electrical power generation of Gas turbine are shown and compared. If we consider Fig.8 and Fig.9, the desired generation of electrical power can be computed with varying the temperature and pressure of the gas at its inlet and outlet. Other factors that are involved in the electrical power generation's behaviour are the internal parameters of the air-compressor, combustion section and gas turbine. To explain the start-up behavior of thermal power plant in more detail, the time period is considered in seconds because small time unit will provide more accurate results. These results are for the first 1118 seconds of the plant's starting as the proposed model could only simulate for 18 minutes. In Fig.9 we can see that the simulated temperature value is initially a little higher. Many factors like humidity in the air, fuel quality or the variations in the fuel sources may cause this difference in the temperature value. In the first 3 minutes, the simulated

TABLE 3. KAPCO plant data for steam turbine.

S.No.	Description	Data Values
1	Make	Siemens, Germany
2	Rated Power	148.6MW
3	No. of Cylinders	2
4	Stages for cylinder-1	26 reaction
5	Stages for Cylinder-2	8+8 Reaction Double flow
6	HP Steam Inlet Pressure	57 bars
7	Temperature	528 deg
8	LP Steam Inlet Pressure	5.78 bars
9	Temperature	221 degC
10	Vacuum	0.091 bars

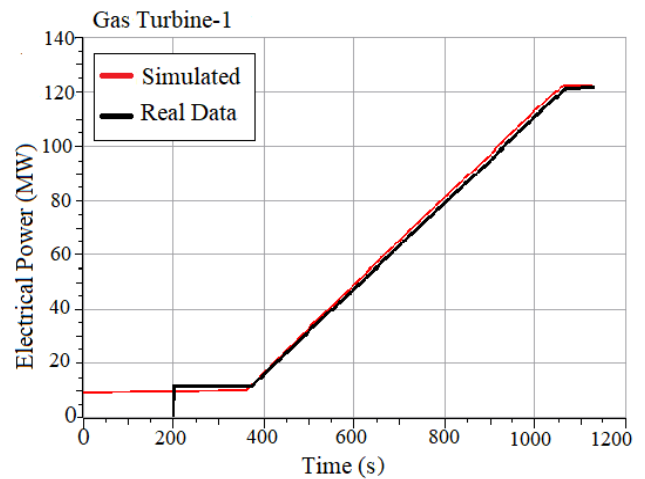

FIGURE 8. Electrical power generation in mega-watts over time for gas turbine-1.

curve is somehow constant than the real data value of the temperature. This difference is due to the simplification that we have used by simulating the electrical power generation of Gas Turbine-1 from the start instead of simulating it after 3 minutes. After 2 to 3 minutes the results were satisfactory and followed the same trend as the real data value of the temperature for the rest of the time.

The temperature started increasing after 360 seconds because at this point the fuel is provided following a ramp signal. Initially fuel is provided with the flowrate of 4.3kg/s which kept increasing following a ramp signal until it reached to the highest value of fuel flowrate 9.35 kg/s. In the proposed model the temperature of the gas turbine can be controlled with the fuel feed and air intake from the air compressor. A detailed comparison of important parameters between real

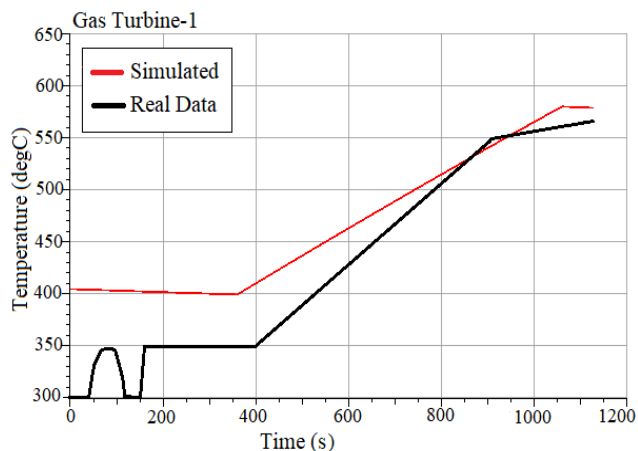

FIGURE 9. Temperature in degC over time for gas turbine-1.

TABLE 4. A comparison between real and simulated values for Brayton cycle.

Description	Parameter	Real Value		Simulated Value	
		Inlet	Outlet	Inlet	Outlet
Air	Pressure(bars)	1.013	13	1.013	13.2
	Compressor Temp(degC)	30	340	30	400
	Flowrate(kg/s)	460.96	460.96	445	445
Combustor	Pressure(bars)	13	13	13.2	12.9
	Temp(degC)	340	1050	400	1104
	Flowrate(kg/s)	460.96	470.32	445	454
Gas	Pressure(bars)	13	1	12.977	1
Turbine	Temp(degC)	1050	563.5	1104	578
	Flowrate(kg/s)	470.32	470.32	454	454

data values and simulated values of various components in the brayton cycle are shown in table 4.

B. GAS TURBINE-2

Gas Turbine-2 has the same parameters with the same characteristics as Gas turbine-1.

The electrical power generation, Temperature and pressure values are the same as Gas turbine-1. The Fig.10 shows the real data line curve and simulated line curve for electrical power generation. A comparison graph between simulated temperature line curve and real temperature data line curve of Gas turbine-2 is shown in Fig.11. The Gas turbine-2 has the same values for parameters as Gas Turbine-1 as described in table 4.

C. COMBINED CYCLE POWER PLANT

The overall proposed Modelica model for KAPCO simulates for the first 18.63 minutes (1118 seconds) which covers

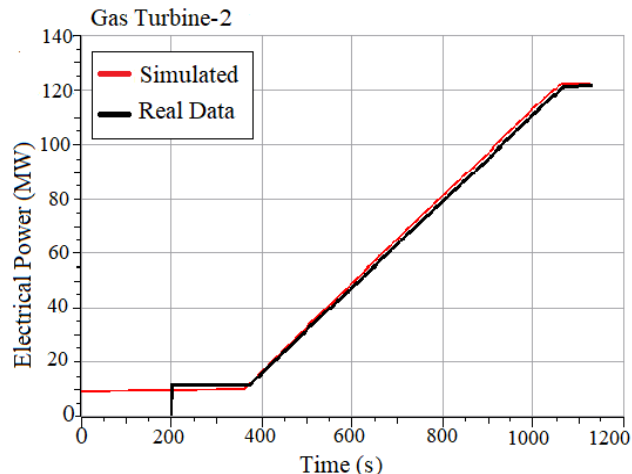

FIGURE 10. Electrical power generation in mega-watts over time for gas turbine-2.

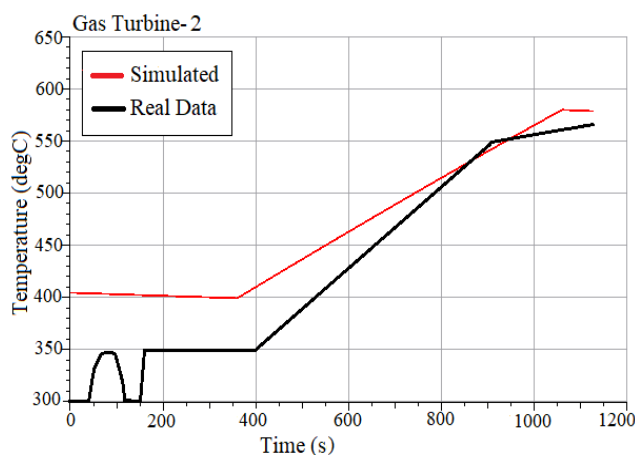

FIGURE 11. Temperature in degC over time for gas turbine-2.

100 percent electrical energy generation of the Gas turbine-1 and covers the same amount of electrical energy generation for the Gas turbine-2. Both Gas turbines generate 246 MW while the single steam system generates almost 145MW. As the steam system reaches to its full electrical energy generation in around 30 minutes (1800 seconds) in the Combined Cycle Power Plant of KAPCO, therefore the proposed model covers more than 60 percent of the total time required for the 100 percent steam electrical energy generation as our proposed model can only be simulated for the first 1118 seconds of the start-up of thermal Power plant.

But the achieved simulation results for the steam system are very satisfactory. The steam electrical power generation very much depends on the exhaust temperature of the gas turbine. The more the temperature of the gas turbine the more enthalpy will be attained by the steam. The initial temperature and pressure of the water from the main water tank are also of the same importance in the generation of the electrical power from the steam turbine. If we compare Fig.9 and Fig.11 with Fig.12, it can be observed that the electrical power generation

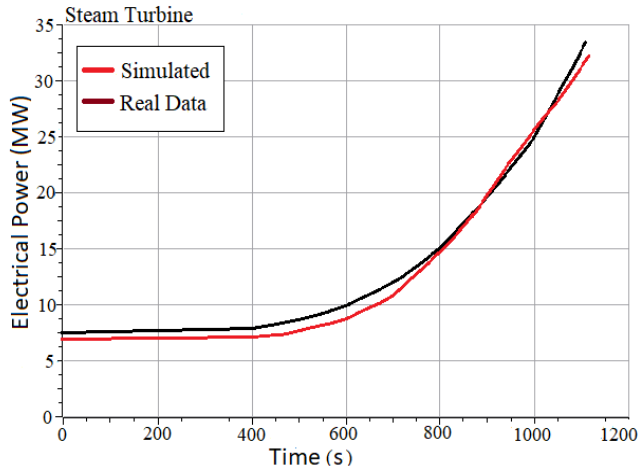

FIGURE 12. Electrical power generation in mega-watts over time for steam turbine.

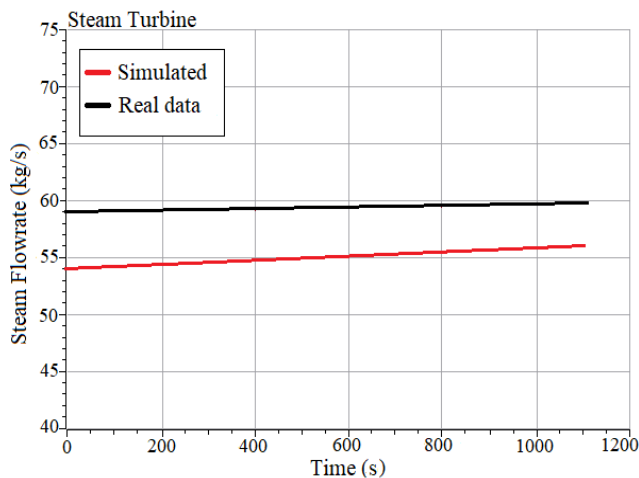

FIGURE 13. Steam flow rate through steam turbine in kg/s.

from the steam turbine is directly proportional to the exhaust temperature of both gas turbines.

Heating surface area of the boiler has the same significance in the CCPP. This part of the steam system decides the efficiency of the CCPP because low heating surface area will not be able to convert enough heat energy of the hot gas into kinetic energy for the steam to produce electrical energy. The proposed model divided the heating surface area according to the KAPCO thermal plant, but heating surface area can be changed by selecting the number of tubes and lengths of heat ex-changers in the proposed model for any thermal power plant. Other factors involved in the generation of electrical energy are steam flow rate and the pressure of the steam. These variables can be controlled with the control valves and the water pumps. So, selecting proper parameters for control valves and water pumps may give us the desired values for the pressure and steam flow rate.

Fig.13 presents a comparison between simulated result and real data of steam flow rate through the steam turbine.

TABLE 5. A comparison between real and simulated values for steam system.

Discription	Parameter	Real Value		Simulated Value	
		Inlet	Outlet	Inlet	Outlet
Main water Tank	Pressure(bars)	2.1325	2	2.2	2.7
	Temp(degC)	130	120	121	118
	Flowrate(kg/s)	72.2	72.2	76	76
LP Water Pump	Pressure(bars)	2	7.903	3.6	7.1
	Temp(degC)	120	120.1	120.9	121
	Flowrate(kg/s)	8.4915	8.4915	8.5	8.5
HP Water Pump	Pressure(bars)	2	77	5.8	60
	Temp(degC)	120	121	118	119
	Flowrate(kg/s)	63.75	63.75	67.4	67.4
LP Water Tank	Pressure(bars)	7.9	3	7.1	2.2
	Temp(degC)	120	133.6	121	134
	Flowrate(kg/s)	8.4915	8.4915	8.5	8.5
HP Water tank	Pressure(bars)	77	56	60	57
	Temp(degC)	121	300	119	274
	Flowrate(kg/s)	30	30	28	28
Stodola Turbine	Pressure(bars)	55	0.9	57.8	0.95
	Temp(degC)	320	35	290	98
	Flowrate(kg/s)	60	60	56	56

There is a notable difference between the simulated and real data line curves especially at the start that reduces with the passage of time. This difference is probably because of the low simulated pressure of water through the HP water pump compare to the real value of pressure as is described in table 5. According to the energy balance of liquid pump the pressure and mass flow rate are directly proportional to each other. Therefore, the simulated flow rate of steam is lower than the real data of steam.

In Fig.14, the electrical energy generation line curves for both gases reached to their 100 percent generation within 18 minutes of the start-up and got stable for the remaining time. On the other hand, the steam turbines could not reach to its 100 percent electrical energy generation because electrical energy generation from steam turbine takes 30 minutes to reach to its 100 percent generation in KAPCO thermal plant. So, this proposed model covers more than 60 percent rankine cycle while 100 percent brayton cycle. Table 6 shows a comparison of the pressures, temperatures and mass flow rates of the real data values and the simulated values from the proposed modelica model. The inlets and outlets of main components of the rankine cycle are compared in table 5. According to [20], to match the achieved

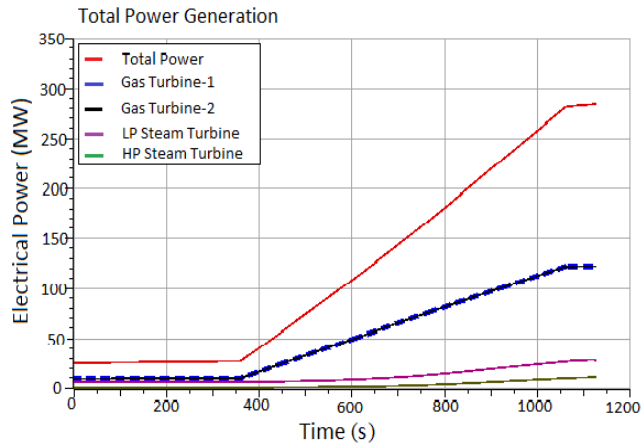

FIGURE 14. Electrical power generation of all four turbines.

TABLE 6. Validation results.

Description	Parameters	RMSE	CV(RMSE) %	MAPE %	MAD
Gas turbine 1 and 2	Electrical Power	4.805	9.83	7.31	3.25
	Temp(degC)	46.328	10.34	10.3	36.95
Steam Turbine	Electrical Power	0.805	6.5	6.2	0.7
	Mass Flow Rate	4.343	8.228	7.3	4.325

simulated results with the actual data for the purpose of validating the proposed model, results of root mean square error (RMSE), coefficient of variance of RMSE, mean absolute deviation (MAD) and mean absolute percentage error (MAPE%) are calculated with eq.(18), eq.(19), eq.(21) and eq.(20).

$$RMSE = \sqrt{\frac{\sum_{t=1}^n (X'_t - X_t)^2}{n}} \quad (18)$$

$$CV(RMSE) = \frac{\sqrt{\frac{\sum_{t=1}^n (X'_t - X_t)^2}{n-1}}}{\frac{\sum_{t=1}^n X'_t}{n}} \quad (19)$$

$$MAPE\% = \frac{\sum_{t=1}^n \frac{|X'_t - X_t|}{X'_t}}{n} \times 100 \quad (20)$$

$$MAD = \frac{\sum_{t=1}^n |X'_t - X_t|}{n} \times 100 \quad (21)$$

where;

X'_t = Simulated value

X_t = Real data

VI. CONCLUSION

For the optimized generation of electrical power from power plant by monitoring the electrical power generation behavior

with respect to load, system simulation is preferred. Therefore, the proposed study used Openmodelica to model the thermal power plant. Openmodelica is a multi-domains software which can properly represent a thermal power system. In the proposed model, all the basic components of gas turbine system and steam turbine system are modeled in detail. The internal power consumption of the thermal power plant was also modeled in the proposed model. The proposed model for the CCPP simulates for the first 18 minutes of the start-up of plant. During this period both Gas turbine systems reach to their 100 percent electricity generation as shown in the Fig.8 and Fig.10. The achieved simulation results cover more than 60 percent of the total time required to reach 100 percent steam electrical power generation as it takes more time to generate 100 percent electrical power. The results for steam turbine are satisfactory and can be seen in the Fig.12 and Fig.13. The simulation results were validated with the real data collected from the KAPCO thermal power plant. The achieved results show the accuracy of the model in the start-up and the base-load conditions.

The proposed model completely covers both Gas turbine systems, but it simulates for 18 minutes which is not enough to cover the complete steam cycle. So, simulation time of the model could be increased to cover the whole steam cycle. Different control valves and water pumps could further be modeled in more detail. For example, the motor for the water pump and the servo motor for the control valves could be modeled further. We recommend a further research on modeling a whole electrical power system including thermal power generation integrated with the renewable energies for a better understanding and for an optimized operation of the overall power system.

ACKNOWLEDGMENT

Mr. Bouskela Daniel (daniel.bouskela@edf.fr) provided technical support for this research work. The authors truly acknowledge the efforts and support offered by Dr. Adeel Javed (Assistant Professor at USPCAS-E, NUST) regarding the data from KAPCO power plant. Dr. Adeel Javed put his great efforts to acquire the data from KAPCO, and we are also thankful to the KAPCO officials/authorities for sharing the data. It is acknowledged that availability of the data such as pressure, temperature, flow rate, and etc. of the main components of the power plant helped us validate the model through comparison between the simulated values and the real data acquired and shared by Dr. Adeel Javed.

REFERENCES

- [1] N. Helistö, J. Kiviluoma, and H. Holtinen, "Long-term impact of variable generation and demand side flexibility on thermal power generation," *IET Renew. Power Gener.*, vol. 12, no. 6, pp. 718–726, Apr. 2018.
- [2] N. Forouzandehmehr, Z. Han, and R. Zheng, "Stochastic dynamic game between hydropower plant and thermal power plant in smart grid networks," *IEEE Syst. J.*, vol. 10, no. 2, pp. 88–96, Mar. 2016.
- [3] S. K. Behera and J. A. Farooque, "Productivity change of coal-fired thermal power plants in India: A Malmquist index approach," *IMA J. Manage. Math.*, vol. 22, no. 4, pp. 387–400, 2011.

- [4] F. Gottelt, T. Hoppe, and L. Nielsen, "Applying the power plant library ClaRa for control optimisation," in *Proc. 12th Int. Modelica Conf.*, Prague, Czech Republic, Jul. 2017, pp. 867–877.
- [5] Y. Dai, L. Chen, Y. Min, P. Mancarella, Q. Chen, J. Hao, K. Hu, and F. Xu, "Integrated dispatch model for combined heat and power plant with phase-change thermal energy storage considering heat transfer process," *IEEE Trans. Sustain. Energy*, vol. 9, no. 3, pp. 1234–1243, Jul. 2018.
- [6] A. Chaibakhsh and S. Amirkhani, "A simulation model for transient behaviour of heavy-duty gas turbines," *Appl. Thermal Eng.*, vol. 132, pp. 115–127, Mar. 2018.
- [7] F. Alobaid, N. Mertens, R. Starkloff, T. Lanz, C. Heinze, and B. Epple, "Progress in dynamic simulation of thermal power plants," *Prog. Energy Combustion Sci.*, vol. 59, pp. 79–162, Mar. 2017.
- [8] F. Gottelt, K. Wellner, V. Roeder, J. Brunnemann, G. Schmitz, and A. Kather, "A unified control scheme for coal-fired power plants with integrated post combustion CO₂ capture," *IFAC Proc. Volumes*, vol. 45, no. 21, pp. 284–289, 2012.
- [9] M. Eremia and M. Shahidehpour, *Handbook of Electrical Power System Dynamics: Modeling, Stability, and Control*, vol. 92. Hoboken, NJ, USA: Wiley, 2013.
- [10] N. Pathak, A. Verma, and T. S. Bhatti, "Automatic generation control of thermal power system under varying steam turbine dynamic model parameters based on generation schedules of the plants," *J. Eng.*, vol. 2016, no. 8, pp. 302–314, Aug. 2016.
- [11] R. Kaisinger, *Electrical Modeling of a Thermal Power Station*. 2011.
- [12] Q. A. Buch, "Dynamic modeling of a steam Rankine Cycle for concentrated solar power applications," Universitat Politècnica de Catalunya, Barcelona, Spain, Tech. Rep., 2013.
- [13] L. Xie, Y. Wu, X. Peng, L. Li, and F. Yi, "Modelling and optimization of heating dispatch in thermal power plant," in *Proc. Chin. Control Decis. Conf. (CCDC)*, May 2016, pp. 3423–3427.
- [14] Q. Luo, K. B. Ariyur, and A. K. Mathur, "Control-oriented concentrated solar power plant model," *IEEE Trans. Control Syst. Technol.*, vol. 24, no. 2, pp. 623–635, Mar. 2016.
- [15] D. Bouskela, "Modeling and simulation of complex ThermoSysPro model with OpenModelica: Dynamic Modeling of a combined cycle power plant," in *Proc. 12th Int. Modelica Conf.*, Prague, Czech Republic, May 2017, pp. 407–414.
- [16] P. Romanos, E. Voumvoulakis, C. N. Markides, and N. Hatzigryriou, "Thermal energy storage contribution to the economic dispatch of Island power systems," *CSEE J. Power Energy Syst.*, vol. 6, no. 1, pp. 100–110, Mar. 2020.
- [17] A. Marjanovic, M. Krstic, Z. Durovic, and B. Kovacevic, "Control of thermal power plant combustion distribution using extremum seeking," *IEEE Trans. Control Syst. Technol.*, vol. 25, no. 5, pp. 1670–1682, Sep. 2017.
- [18] A. Ghaffari, A. Chaibakhsh, and S. Shahhoseini, "Neuro-fuzzy modeling of heat recovery steam generator," *Int. J. Mach. Learn. Comput.*, vol. 2, pp. 49–53, 2013.
- [19] A. Chaibakhsh, S. A. A. Moosavian, and A. Ghaffari, "Experimental fuzzy modelling and control of a steam power plant boiler," *Int. J. Model. Simul.*, vol. 29, no. 4, pp. 379–386, Jan. 2009.
- [20] I. Mahmood, Q. Tul-Ain, H. A. Nasir, F. Javed, and J. A. Aguado, *A Hierarchical Multi-Resolution Agent-Based Modeling and Simulation Framework for Household Electricity Demand Profile Simulation*. London, U.K.: Sage, 2020.
- [21] I. Mahmood, T. Kausar, H. S. Sarjoughian, A. W. Malik, and N. Riaz, "An integrated modeling, simulation and analysis framework for engineering complex systems," *IEEE Access*, vol. 7, pp. 67497–67514, 2019.



existing conventional power systems.

HAFEEZ ANJUM received the B.S. degree in electrical engineering from the University of Engineering and Technology, Taxila, Pakistan, in 2015, and the M.S. degree in power and control systems from the College of Electrical and Mechanical Engineering, National University of Science and Technology, Pakistan. His research interests include optimization and control of power systems, modeling and simulation of systems, and integration of intermittent energy sources with the



interests include grid integration of renewable energies, PV-powered smart charging of electric vehicles, and direct load control strategies for peak-shaving in power systems.

AZHAR UL-HAQ received the Ph.D. degree in electrical engineering from the Joint Research Doctoral Program, University of L'Aquila, Italy, and the University of Waterloo, Canada. He worked as a Research Assistant with the ECE Department, University of Waterloo, in 2015. He has been working as an Assistant Professor with the Department of Electrical Engineering, National University of Sciences and Technology, Islamabad, since October 2016. His research inter-



applied modeling, simulation, analysis, and visualization of complex systems. He is the Principal Investigator of the applied research grant project "Simulation modeling, analysis and forecasting of electricity generation and consumption in Pakistan using system dynamics approach" (ARG-004) funded by the U.S.–Pakistan Center for Advanced Studies in Energy, National University of Sciences and Technology.

IMRAN MAHMOOD (Member, IEEE) received the master's and Ph.D. degrees in computer systems from the School of Information and Communication Technology, KTH Royal Institute of Technology, Sweden, in 2007 and 2013, respectively. He is currently serving as an Assistant Professor with the Department of Computing, School of Electrical Engineering and Computer Science, National University of Sciences and Technology, Pakistan. His current research interests include

• • •