

Journal Pre-proof

The Aluminium Industry: A Review on State-of-the-Art Technologies, Environmental Impacts and Possibilities for Waste Heat Recovery

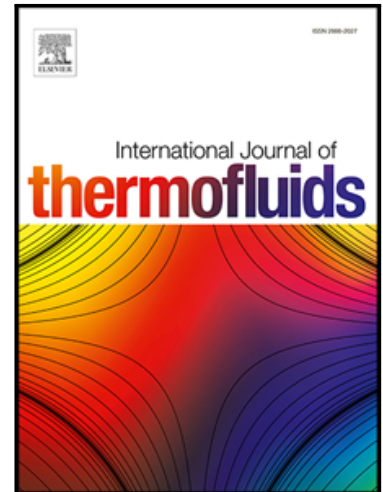

Daniel Brough , Hussam Jouhara

PII: S2666-2027(19)30007-2
DOI: <https://doi.org/10.1016/j.ijft.2019.100007>
Reference: IJTF 100007

To appear in: *International Journal of Thermofluids*

Received date: 24 October 2019
Revised date: 4 December 2019
Accepted date: 9 December 2019

Please cite this article as: Daniel Brough , Hussam Jouhara , The Aluminium Industry: A Review on State-of-the-Art Technologies, Environmental Impacts and Possibilities for Waste Heat Recovery, *International Journal of Thermofluids* (2020), doi: <https://doi.org/10.1016/j.ijft.2019.100007>

This is a PDF file of an article that has undergone enhancements after acceptance, such as the addition of a cover page and metadata, and formatting for readability, but it is not yet the definitive version of record. This version will undergo additional copyediting, typesetting and review before it is published in its final form, but we are providing this version to give early visibility of the article. Please note that, during the production process, errors may be discovered which could affect the content, and all legal disclaimers that apply to the journal pertain.

© 2019 The Author(s). Published by Elsevier Ltd.

This is an open access article under the CC BY license. (<http://creativecommons.org/licenses/by/4.0/>)

Highlights:

- The aluminium industry is highly energy intensive, has significant environmental impact and release a large proportion of energy as waste heat.
- The production energy required, energy losses and energy content of the waste heat is quantified.
- The environmental impact of each aluminium production stage is described with focus on the refining, primary and secondary industries.
- Equipment used within each process step with potential for waste heat recovery is described.
- Waste heat can be reused utilising heat recovery technologies to reduce energy consumption among other benefits.

Journal Pre-proof

The Aluminium Industry: A Review on State-of-the-Art Technologies, Environmental Impacts and Possibilities for Waste Heat Recovery

Daniel Brough^a and Hussam Jouhara^{a,*}

^a College of Engineering, Design and Physical Sciences, Brunel University London, Uxbridge, Middlesex, UB8 3PH, London, UK.

* Corresponding Author. Email address: hussam.jouhara@brunel.ac.uk (H. Jouhara).

Abstract

Aluminium is becoming more frequently used across industries due to its beneficial properties, generally within an alloyed form. This paper outlines the entire production process of aluminium from ore to the finished metallic alloy product. In addition, the article looks at the current state of the art technologies used in each discrete process step. Particular interest is directed towards casting technologies and secondary recycling as the relative proportion of recycled aluminium is increasing dramatically and aluminium is much more energy efficient to recycle than to produce through primary methods. Future developments within the industries are discussed, in particular inert anode technology. Aluminium production is responsible for a large environmental impact and the gaseous emissions and solid residue by-products are discussed. In addition to the environmental impact, the industry is highly energy intensive and releases a large proportion of energy to atmosphere in the form of waste heat. One method of reducing energy consumption and decreasing the environmental impact of emissions is by installing waste heat recovery technology. Applied methods to reduce energy consumption are examined, with a latter focus on potential applications within the industry for waste heat recovery technologies.

Keywords: Aluminium production; Aluminium production environmental impact; Waste heat recovery; Waste heat recovery technology; Waste heat recovery applications.

Nomenclature

Abbreviations	Circulating Fluid Bed
and	
Acronyms	
CFB	
CFD	Computational Fluid Dynamics
DC	Direct Current
EU	European Union
GDP	Gross Domestic Product
GHG	Greenhouse Gas
GTC	Gas Treatment Centre
GWP	Global Warming Potential
MEA	Monoethanolamine
OCP	Optical Coil Protection
ORC	Organic Rankine Cycle
PAH	Polyaromatic Hydrocarbons
PBF	Packed Bed Filter
PFC	Perfluorocarbon
POCP	Photochemical Ozone Creation Potential
ROI	Return on Investment
RSM-UD	Response Surface Methodology and Uniform Design
RTO	Regenerative Thermal Oxidisers
SPL	Spent Pot Lining
STP	Standard Temperature and Pressure
US	United States
VOC	Volatile Organic Compound
WHR	Waste Heat Recovery
WSFP	Water Scarcity Footprint

Chemical formulae

Al_2O_3	Aluminium Oxide
$\text{Al}(\text{OH})_3$	Aluminium Trihydrate
AlF_3	Aluminium Fluoride
CF_4	Tetrafluoromethane
C_2F_6	Hexafluoroethane
CaF_2	Calcium Fluoride
CaO	Calcium Oxide (lime)
CH_4	Methane
CO_2	Carbon Dioxide
C_2H_6	Ethane
H_2	Molecular Hydrogen
H_2O	Water

H ₂ S	Hydrogen Sulphide
HF	Hydrogen Fluoride
KCl	Potassium Chloride
MgAlO ₄	Magnesium Spinel
MgO	Magnesium Oxide
Na ₃ AlF ₆	Cryolite
NaAl(OH) ₄	Sodium Aluminate
NaCl	Sodium Chloride
NaF	Sodium Fluoride
NH ₃	Ammonia
NaOH	Sodium Hydroxide
NO _x	Nitrogen Oxide
	Species
PH ₃	Phosphine
SO ₂	Sulphur Dioxide
SiO ₂	Silicon Oxide

Subscripts and Superscript

<i>a</i>	Available
<i>Al</i>	Aluminium
<i>c</i>	Combustion
<i>eq.</i>	Equivalent
<i>g</i>	Gaseous
<i>l</i>	Liquid
<i>m</i>	Melting
<i>non-aq</i>	Non-aqueous
<i>p</i>	Product
<i>s</i>	Solid

Symbols and Units

<i>A</i>	Heat transfer area	m ²
<i>C_p</i>	Specific heat	J.kg ⁻¹ .K ⁻¹
<i>H</i>	Enthalpy	J.kg ⁻¹
<i>h</i>	Convective heat transfer coefficient	W.m ⁻² .K ⁻¹
<i>Q</i>	Energy	J
<i>Q̇</i>	Heat transfer rate	W
<i>S</i>	Seebeck coefficient	V.K ⁻¹
<i>T</i>	Absolute Temperature	K
<i>U</i>	Overall convective heat transfer coefficient	W.m ⁻² .K ⁻¹
<i>Ṁ</i>	Volumetric flowrate	m ³ .s ⁻¹
<i>x</i>	Width	m
<i>zT</i>	Thermoelectric figure of merit	Dimensionless
<i>ΔT_{lm}</i>	Logarithmic mean temperature difference	K

Greek Symbols

<i>Δ</i>	Difference	Dimensionless
<i>η</i>	Efficiency	Dimensionless
<i>κ</i>	Thermal conductivity	W.m ⁻¹ .K ⁻¹
<i>ρ</i>	Density	kg.m ⁻³
<i>σ</i>	Electrical conductivity	S.m ⁻¹

1. Introduction

There is a global surge in the zeitgeist towards reducing consumption of natural resources and decreasing pollution. This is evidenced by government incentives, world goals, ambitious EU energy targets, active citizen protests and the increased contribution of renewable energy sources. Examples of these include 195 signatories for the 2016 Paris Agreement [1], EU 2030 energy targets [2], the EU commission aim to reduce greenhouse gas (GHG) emissions to 80-95% below 1990 levels by 2050 [3], 1151 activists arrested as part of the April 2019 'Extinction Rebellion' protests in London [4] and the commitment of the United Kingdom government to achieve 'net zero' GHG emissions by 2050 [5]. This change in mood can partly be attributed to the increased awareness of the importance of the sustainability and stability of the environment and the impact human activity is having on the planet.

In saying this, economies are highly driven by industrial sector performance. In 2017, the industrial sector was accountable for 30.5% of total GDP worldwide. For the United Kingdom, the industrial sector contributed 20.2% of GDP, which is growing at a rate of 3.4%, with 15.2% of the available labour force working in the industrial sector [6]. However, worldwide, the industrial sector is responsible for 33% of GHG emissions [7] from 26% of primary energy consumption [8]. Moving forward, the conscientious use of natural resources should be at the forefront of sustainable plant design. Historically inefficient plants can be upgraded or retrofitted with modern technology to reduce energy usage. One of the methods of reducing energy usage is by recovering, reclaiming or reuse of waste heat generated. The reclamation of heat is a particular area of interest as it has been reported that 70% of global energy demand in the industrial sector is for heat or thermal processes [7], 72% in the United Kingdom [9].

After steel, aluminium is the most highly produced metal and the most produced non-ferrous metal [10,11], being produced in a higher volume than all other non-ferrous metals combined [12]. Aluminium is being used to replace steel components, particularly in the aerospace and automotive industries. It is reported that for each kilogram of aluminium that replaces mild steel, high strength steel and cast iron avoids 13-20 kg of GHG emissions [13]. The extensive use in the building, packaging, automotive, aerospace and electrical distribution industries, as well as its relative value, has meant that it is one of the most recycled commodities.

According to the Aluminium Association, 90% of aluminium in building and automotive parts is recycled at end of life [14]. Moreover, 75% of aluminium that has historically been produced is still in circulation today [15,16]. In 2010, the United Kingdom was producing approximately 343 kt and 260 kt per year of primary and secondary aluminium, respectively [17]. The two largest of the three primary smelters in the United Kingdom have ceased operations with the last producing *c.*40 kt of primary Aluminium a year.

The aluminium industry is a highly energy-intensive process and it uses elevated temperatures throughout with significant environmental impact at all stages. It is estimated that the aluminium industry produces 0.45-0.5 Gt of carbon dioxide (CO₂) equivalent emissions per year [18,19], is responsible for 1% of anthropogenic GHG emissions [20] and

2.5% of CO₂ emissions [21]. Heat recovery technologies can be used to reduce these emissions and also lower fuel and electricity usage [22]. Any reduction in fuel and electricity usage gives a healthier company image of corporate and social responsibility, a reduced CO₂ footprint, sustainability, as well as impacting significantly on profitability. For these reasons, exploring waste heat recovery (WHR) for reuse in the process has been heavily targeted by companies of all industries as an avenue in which to invest. In this regard, the study of the aluminium industry is of great importance, particularly due to intensifying concern regarding global warming, GHG emissions, and the rising trend in fuel prices.

2. Overview of Aluminium Production

Some call the age in which we live, the 'Information Age' due to the vast increase in economic value based on information technology, moving away from traditional economies based on the 'Industrial Revolution'. Others have referred to the current era as 'The Aluminium Age' [23] due to the exponential increase in its production and use in daily products. In order to fully understand the global aluminium industry's workings, the following sections give a brief history of how aluminium was discovered and historically produced, what modern practices of production are, and the technology used within each activity. From this, the opportunities for WHR can be ascertained, their magnitudes investigated, and current technology assessed for their benefits and limitations of implementation.

2.1. History of Aluminium Production

Aluminium as a commodity is a relatively new concept in our history. The reason for this is that it is an element in group 13 of the periodic table and can form extremely stable compounds with other elements, typically as a 3+ cation [24]. It readily reacts with oxygen in the atmosphere to form aluminium oxide, Al₂O₃. As it is not freely available in its elemental form, it was not isolated till relatively late. Aluminium was first named in 1808 by Humphry Davy when he theorised that aluminium would be a product of electrolytic reduction of aluminium oxide. Davy did not prove this theory; it took until 1845 for Friedrich Woehler to produce the first pure aluminium sample. The French chemist Saint-Claire Deville developed the first industrial application in 1856 and over 36 years produced only 200 tonnes of aluminium. It was not until 1886 that the current method of producing primary Aluminium was established. In the same year, but independently on different continents, Paul Héroult and Charles Hall first discovered the reduction of molten aluminium oxide in cryolite (Na₃AlF₆) as a cheaper method of production with both sharing the patent and hence the process was named the Héroult-Hall process. Karl Joseph Bayer, discovered in 1887 that alumina could be extracted from the ore, bauxite, (named after the Les Baux province in France) and be used as a cheap feedstock for the Héroult-Hall process. The extraction process used an alkaline solution (Na₂CO₃) to selectively dissolve Al₂O₃ from other impurities within the ore and then recrystallise it in a purer form. The modern procurement process described below uses these key foundations developed by scientists over the years. [25,26]

2.2. Current Aluminium Production

Aluminium is the most abundant metallic element (7.96%) and third most common element found in the earth's crust [27]. Due to its reactivity, particularly with oxygen, it is very rarely found in its elemental form so requires extracting from minerals in ores. Globally, in 2016 alone, the world mined 289 Mt of bauxite ore, produced 118.9 Mt of aluminium oxide (alumina) and smelted 58.8 Mt of primary aluminium [10]. These figures are only predicted to rise, in part due to advancements in aluminium alloy metallurgy, increase in population and economic activity generating a larger demand [18]. There are a range of predictions on the increase in global demand for aluminium. It has been reported that demand will double in the next ten years [28], others have more conservatively predicted doubling or tripling by 2050 [29,30]. Following this, the unavoidable use of natural resources will increase.

Shown in Figures 1 and 2 are overviews of the material flow of aluminium and the procurement process and predicted global mass flow rates for 2019. Figure 1 shows a block diagram of the procurement process from mining to secondary production with each industry indicated. Figure 2 shows the mass flow rate in kt of each production step and how they interact with each other.

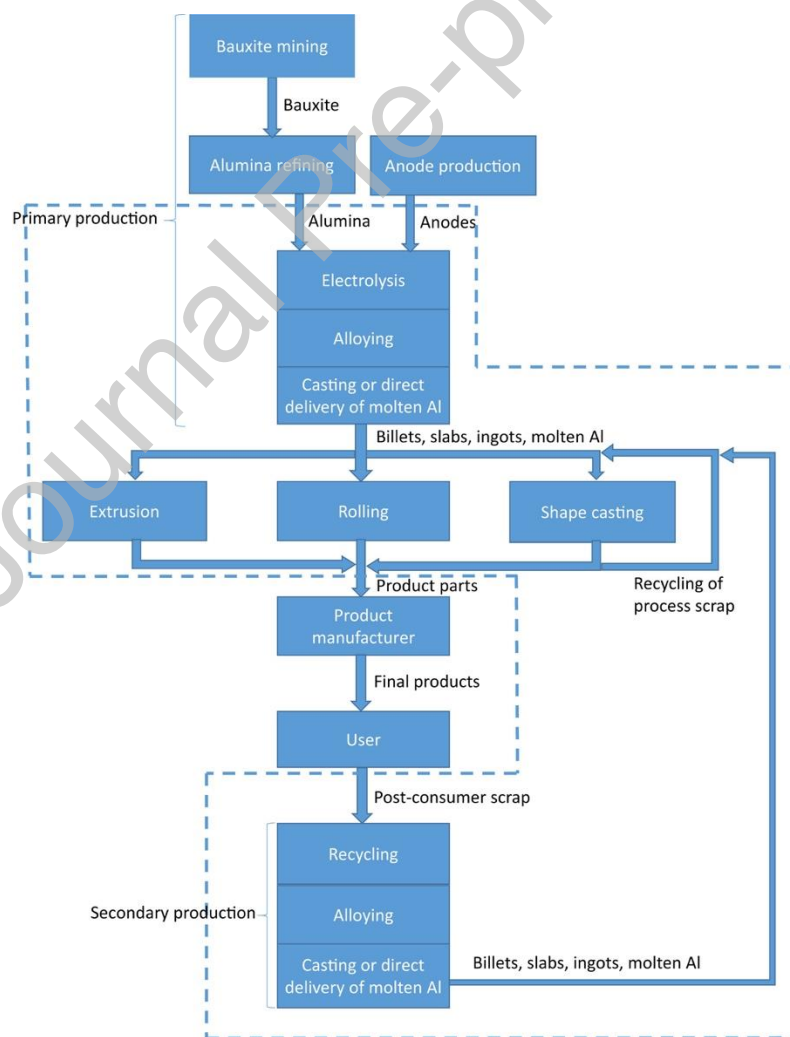

Figure 1: A schematic of the production process. Reproduced from [31].

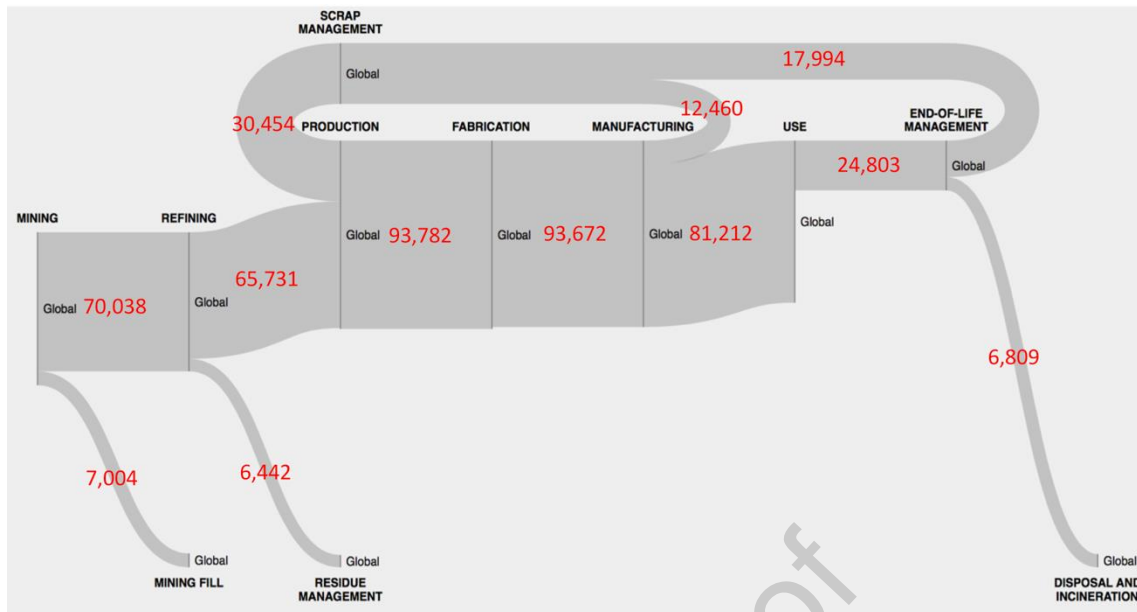

Figure 2: An overview of the production process with predictions of 2019 mass flow rates/ kt in red. Adapted from [32].

2.2.1. Mining Process

Aluminium is rarely found in its elemental form and so requires extraction in order to produce the quantity in demand. The principal ore used for aluminium extraction is bauxite, accountable for more than 99% of primary aluminium production [12]. Bauxite ore is mined predominantly from open cast mines on the earth's surface [18,20]. It contains between 40-60% alumina [33] and typically 50-55% [18] as aluminium oxo-hydroxides compounds in three main forms: gibbsite ($\text{Al}(\text{OH})_3$), boehmite ($\gamma\text{-AlO}(\text{OH})$), diasporite ($\alpha\text{-AlO}(\text{OH})$) [34]. Due to further oxide and compound content, the majority requires refining. It is reported that 85% of bauxite mined is sent to refiners to produce aluminium oxide [35]. The largest producers of bauxite, in order, are Australia, China, Brazil, Guinea and India [10]. Due to the abundance of bauxite ore and the increase in secondary production and recycling, the worldwide reserves, estimated to be between 55-75 Gt, can meet demand for many centuries [10,36]. Therefore, unless a different production method is developed and globally introduced, there are long term opportunities for recovery throughout the process.

2.2.2. Refining Process

The Bayer process is the most commonly used refinement route, though certain countries use alternatives called the combined or parallel Bayer-Sinter process and the Nepheline-based process [20,37]. This section describes purely the Bayer Process. Due to the impurities in the bauxite ore, it requires treatment to produce purer alumina, Al_2O_3 [18]. This is achieved by adding blended and ground bauxite, for consistent infeed, to a pressure vessel at 145-265°C, *c.* 3.5 MPa, with sodium hydroxide (NaOH), conditions are chosen dependent on the aluminium compounds present [38,39]. The compounds dissolve to form an equilibrium, with the conditions pushing the reaction to the right to form hydrated $\text{NaAl}(\text{OH})_4$ by the following adapted Equations 1 and 2 [40,41]. This is referred to as digestion.

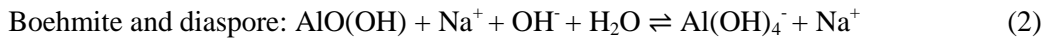
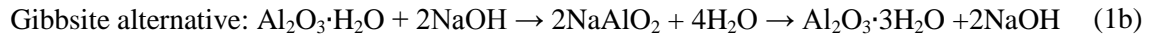
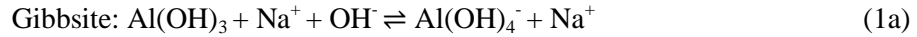

The solution, known as a slurry, is filtered to remove impurities and insoluble compounds such as coarse particles and sodalite [42], a sodium aluminosilicate precipitate, from the reaction and chemically treated to remove other soluble compounds to form a supersaturated sodium aluminate liquor. Examples of this include using lime (CaO) [41] to remove phosphates and vanadium. It is then cooled in the presence of seeded crystals of Al(OH)_3 to reverse Equation 1 and push the equilibrium to the left. The sodium hydroxide is recycled and the aluminium hydroxide is heated at around 1000°C in a rotary kiln or calciner to remove water and produce anhydrous aluminium oxide [38], shown by Equation 3:



The anhydrous aluminium oxide is then transported to the primary smelters or other industries for processing. A typical bauxite refining plant is shown in Figure 3. An overview of a typical refining process is provided in Figure 4 with all discrete steps.



Figure 3: An aerial view of the largest alumina refinery, Alunorte. Reproduced from [43].

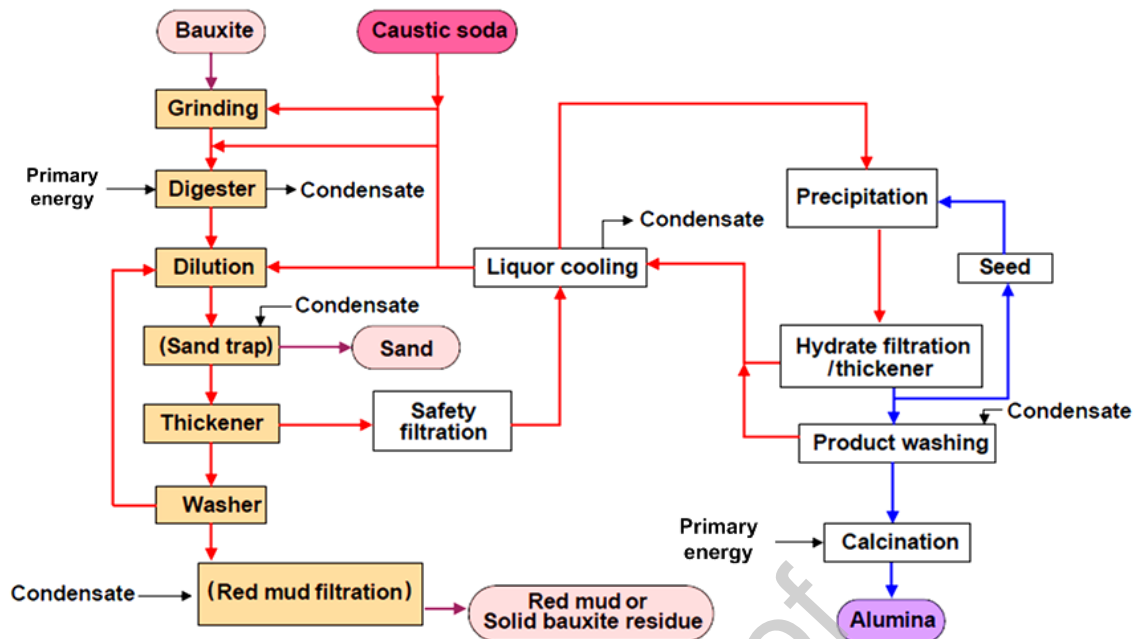
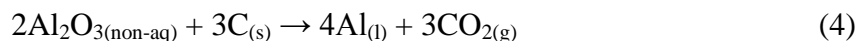

Figure 4: An overview of the refining process. Reproduced from [42].

2.2.3. Primary Smelting Production

90-95% of refined aluminium oxide produced by the Bayer process is sent to primary aluminium smelters through the Hall-Héroult process [18,40]. The balance is used for abrasives, cement, chemical production [35] or proppants [44]. The Hall-Héroult process involves two main approaches, Prebake or Søderberg [18] with Prebake being the more modern technology. Though these two methods use different cell technologies, the process is generally similar and described in a later section. Periodically in both electrolytic cell types, powdered aluminium oxide is dissolved in molten cryolite (Na_3AlF_6) and aluminium fluoride (AlF_3) in a cell at $950\text{-}1000^\circ\text{C}$ [20,33,45]. Electricity passes through the electrolyte between a carbon anode, introduced from the top or side, and cathode cell lining under 5V $40\text{-}400\text{ kA}$ DC [46,47] to electrolytically reduce the aluminium oxide to form aluminium and predominantly CO_2 . This process of reduction of alumina is shown by Equation 4, adapted from [46]. It is predicted by 2020 that $500\text{-}600\text{ kA}$ cells will be operational [48].



Current efficiencies have been reported as being at around 95-96% from a study of over 50 different prebake cell technologies of smelters worldwide [47]. During the reduction process, the molten aluminium sinks to the bottom of the cell where it is periodically siphoned or tapped and the compositionally pure (99,5-99,9%) metal is then sent to a cast house or rolling mill to create the final form. It has been reported that it takes 13-16 MWh of electricity to create one tonne of aluminium from 2.7 t of bauxite [18,49]. Misleadingly, some primary smelters re-melt pure grades of aluminium scrap with the primary metal from smelting and this is still deemed primary metal.

Due to the large energy demand, primary smelters require close proximity to a power station. To reduce GHG emission, many are located close to water in order to utilise more environmentally friendly hydropower and to establish ports at sea. For this reason, 75% of primary aluminium production is powered from hydroelectric power sources [14]. Figure 5 depicts a world map showing the quantities of primary aluminium produced in 2018 by continent. It can be seen that China significantly dominates production of primary aluminium worldwide.

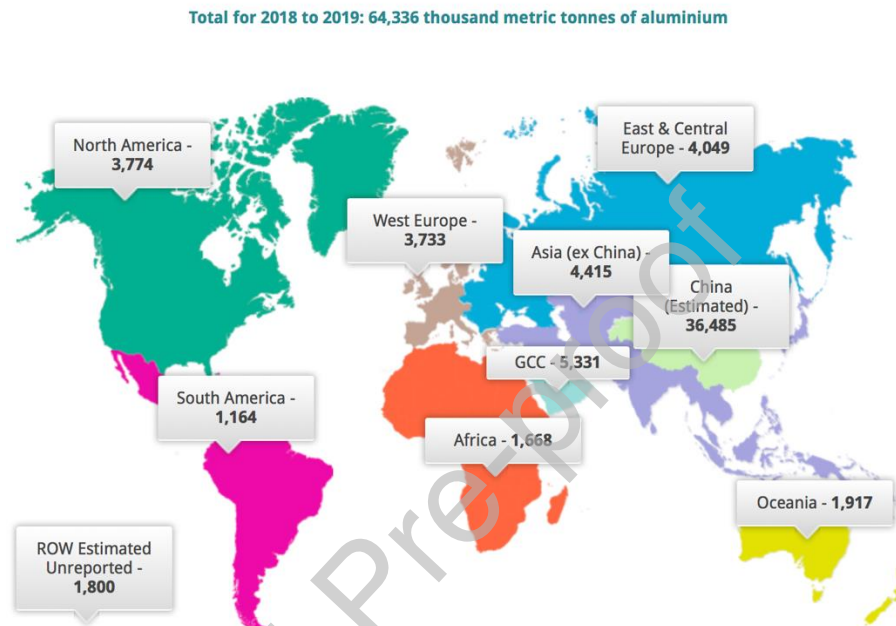

Figure 5: Worldwide quantity/kt of primary aluminium produced in 2018. Reproduced from [50].

2.2.4. Secondary Smelting Production

The reason 90% of aluminium in building and automotive parts is recycled at end of life [14] and 75% that has historically been produced is still in circulation today [15] is due to the ease of recycling of aluminium and its relative value. Domestically, aluminium is the most valuable item put into a recycling bin [14]. Secondary aluminium production involves re-melting aluminium, in a variety of furnaces, from: manufacturing processes (e.g. swarf, extrusion offcuts, stampings); internal process arisings (e.g. slag metallics, dross, quality failed ingots) and end of life recyclables (e.g. cast or wrought products). This aluminium is known as scrap. The scrap is firstly sorted into its alloy type, described in a later section, in order to have a good understanding of what the composition of a melt will be. Different methods of sorting and separating scrap are provided by [51] and include: magnetic separation to remove ferrous material; air separation to remove plastic, foams and rubber; eddy current separation to selectively recover aluminium; dense media separation to sort material by density; manual hand sorting; hot crushing to separate wrought from cast products and other emerging technologies.

Some scrap has contaminants on it such as oil, paint, water, coatings. These can be removed by using centrifuges or de-coating machines. This is done so that less emissions are released, energy is not wasted putting non-aluminium into the furnace and to reduce oxidation meaning less dross is formed, increasing metallic yield from the furnace. Other processes like briquetting swarf provides a higher density, lower surface area material to melt. This material takes less time to charge into a furnace, is more handleable and the recovery yield is greater. Other metallic contaminants, like iron can be magnetically separated. Bulky scrap like alloy wheels can be fragmented. [51,52]

Some secondary smelters melt only one type of scrap, e.g. engine blocks and so there is a very good idea of the final composition of the metal that will be produced, and little additional alloying is required. Others create alloys by purposely mixing different grades of scrap and adding minor elements.

Table 1 shows the average elemental spectrograph analysis of a year's worth of melt specifications from a secondary smelter supplying the automotive industry.

Table 1: Yearly average elemental analysis from a typical UK smelter supplying the automotive industry. Provided by [53].

Balance(Al)	Cu	Mg	Si	Fe	Mn	Ni	Zn	Pb	Sn	Ti	Cr
~86%	2.0082	0.2312	9.1901	0.8025	0.2528	0.0403	0.8861	0.0306	0.0113	0.055	0.0543

Historically, secondary aluminium was considered of poorer quality to primary aluminium due to inclusions and a lack of compositional control [11]. However, technological advances and the introduction of alloy standards now mean that secondary aluminium retains its performance and strength properties after recycling and so the secondary process can be repeated indefinitely to save costs and multiply the environmental benefits [54]. However, it is practically impossible to remove some elements from an alloy and so purer aluminium is needed to control minor elemental build up.

Due to the quality of secondary metal improving over the years, being almost infinitely recyclable and being much more energy efficient to produce, in the future it has been speculated that the main source of aluminium will be recycled secondary metal, in essence, switching from being a top-up balance to the main source [55]. Work has to be done on ensuring that the unavoidable build-up of minor elements that occurs naturally during the recycling process is kept in control [51]. For example, from ladles, launders and incorrectly segregated materials. Also, high aluminium composition ingots can be very difficult to make through the secondary process due to the lack and expense of pure grade scrap.

As it only takes *c.*5% [11,49] of the energy to recycle rather than produce aluminium through a primary route and its ability to be endlessly recyclable, re-use of existing material should naturally be the sensible choice for the main procurement route. In this regard, developing extremely energy efficient secondary aluminium smelters is of paramount importance to future generations and conscientious procurement. The secondary aluminium sector is growing, and it uses much less energy than primary aluminium production, with less

environmental impact. Furthermore, it sources recycled material rather than virgin resources and the process can be repeated indefinitely. However, it is a purely transformational process and the energy used to convert solid scrap to a solid alloy of consistent specification is lost to the environment, most in the form of waste heat. To mitigate the scale of these losses and reduce energy usage, WHR technologies can be implemented [22].

2.2.4.1. Forms of Aluminium Products from a Cast House

The common products of secondary smelters are ingots, billet or sow to their customer's provided specification. These customers, for example, die casters and extruders, re-melt the alloy at a separate site to form the final product. Some foundries, which are located near their customer's site, transport molten metal in a crucible to avoid the capital expense and operational costs of re-melting the solid alloy prior to their process. Figure 6 shows these common forms.



Figure 6: Aluminium products (L-R): ingot [53], sows [56], slab [57], billet [58], molten Al crucibles [59].

The alloys created by primary and secondary smelters are named after their elemental composition. Each alloy designation has a set percentage elemental range. The categorisation nomenclature is described below.

2.2.5. Alloys and Series Designation

Aluminium in its pure form does not necessarily have desirable characteristics which is why it is common practise to add other elements to form an alloy [60]. This is done to attain desired properties or characteristics in both the primary and secondary industries prior to casting to provide a desired customer alloy specification. Many research departments work on developing and testing new alloy compositions to achieve desired properties, for example: corrosion resistance, machinability and ductility.

Each scrap material has a different elemental composition due to the characteristics and properties initially desired for the original product. Recycling establishments collect and sort scrap into their varying alloys or series. Depending on the complexity of the foundry and quality of scrap infeed used, the process can be to melt down and recast the aluminium of a particular composition or multiple alloy types can be melted in one batch to create a new specification with the addition of other elements, also sometimes recycled. Starke and Mridha [61] provide a comprehensive guide to aluminium alloy designation by the alloy, heat treatment and temper.

2.2.5.1. Cast vs Wrought Alloys

The first step in the allocation of alloys is whether they fall into a wrought or cast alloy type. Wrought alloys contain a lower percentage of elements in order to retain the ductile characteristics of the aluminium in the alloy as wrought products are mechanically worked i.e. rolled, forged, pressed or extruded. A typical example of a wrought product is a rolled aluminium sheet or extruded window frame section. Cast alloys are designed to be cast into shape and finished by machining. The alloying elements used are the same as with wrought alloys but usually in a much higher percentage to aid with attaining the properties desired for cast product. A typical example of a final cast product is an aluminium engine block. [60]

Wrought alloys are named by the International Alloy Designation System, which is widely accepted. Chemical compositions and nominal densities are provided for wrought alloys by [62]. A wrought alloy is named using a four-digit system to aid ease in identifying the composition and alloying elements. The first of the four numbers denotes the major alloying element, summarised in

Table 2, with typical uses. More detailed applications are given by [60].

Journal Pre-proof

Table 2: A summary of wrought aluminium alloy designations. Adapted from [62].

Alloy Group	Main Alloying element	Selected Uses
1xxx	Unalloyed, Aluminium >99%	Drawn tube, foil, aerospace and electrical conductors.
2xxx	Copper	Sheet, plate, aerospace, forgings.
3xxx	Manganese	Beverage cans, sheet, materials requiring work hardening.
4xxx	Silicon	Rods, forgings, extrusions, materials requiring work hardening.
5xxx	Magnesium	Sheet, plate, rod, extrusions, aerospace, marine, welding wire, automotive.
6xxx	Magnesium and Silicon	Sheet, plate, aerospace, forging, extrusions, materials requiring heat treatment.
7xxx	Zinc	Aerospace, plate, sheet, foil.
8xxx	Other elements	Aerospace, electrical distribution.
9xxx	Unused series	N/A.

Cast aluminium alloys use different designation systems mostly depending on the region. One has been developed by The Aluminium Association. The numbering system is made of 4 digits with a decimal point with either a 0, 1 or 2. xxx.0 denotes a casting and xxx.1/2 denotes an ingot. As with wrought alloys above, the first digit denotes the major alloying elements. The second and third number denotes what the minimum composition of aluminium should be [60]. The alloys can also be followed by an alphabetical code for their temper designation in the form xxxx-x with the final x being: F (no treatment), H (strain hardened), O (fully annealed), T (tempered by heat treatment), W (solution heat treated) [48].

3. Environmental Impact of Aluminium Production

The aluminium production process requires many other background processes and materials that contributes to a full life cycle assessment. These were best described by [63], and include bauxite transport, alumina transport, calcined lime production, cathode carbon production, aluminium fluoride production, pitch production, petrol coke production, anode production and anode butt production. A detailed inventory of all the inputs and outputs of the aluminium production processes is provided by [64]. The environmental impact of aluminium production is shown below.

3.1. Acidification Potential

Acidification potential is ‘a measure of emissions that cause acidifying effects to the environment and is expressed as kilogram sulphur dioxide (SO₂) equivalent’ [65]. There are three main acidifying emissions from aluminium production. These are nitrogen oxides (NO_x), SO₂ and ammonia (NH₃). 77% of the emissions relate to the electrolysis process, 18% to refining and the balance between casting and mining (Figure 7). Interestingly, 74% of all acidification emissions are due to electricity generation. [65]

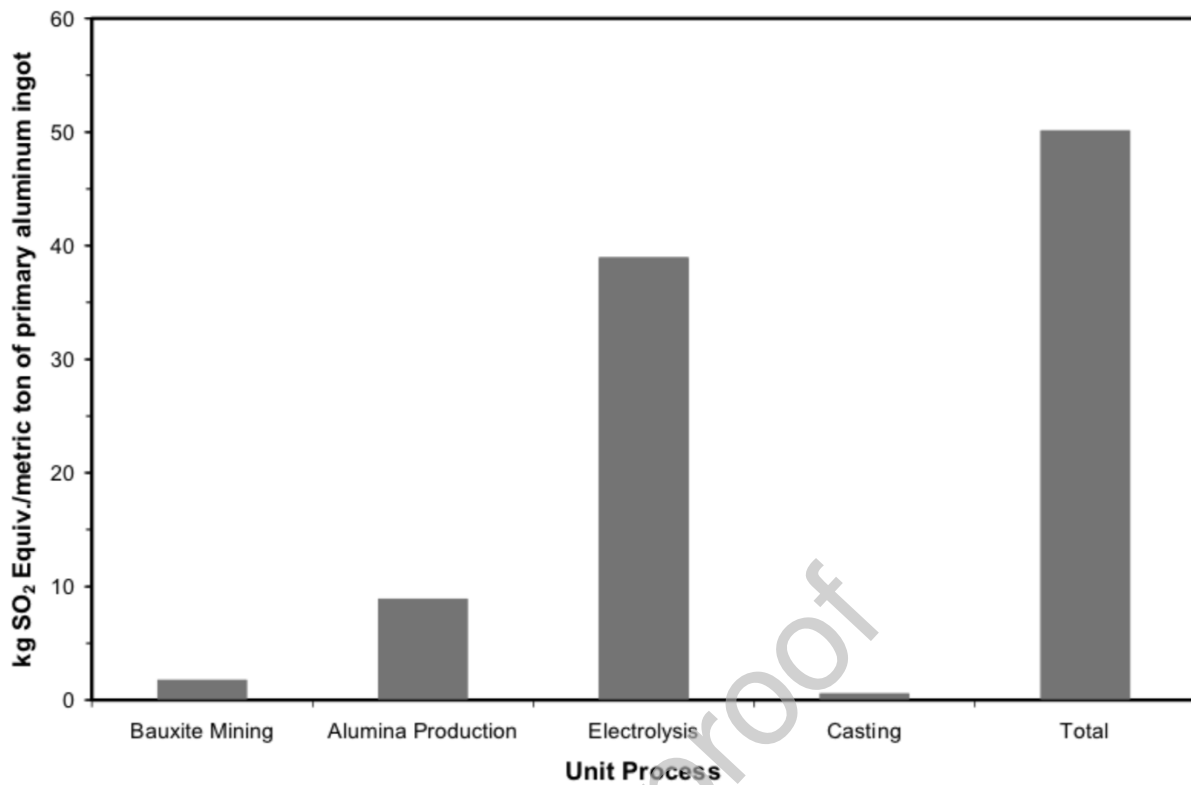

Figure 7: US primary industry acidification potential by process step, reproduced from [65].

3.2. Depletion of Fossil Energy Resources

In 2018, it required an average of 11,359 MJ per tonne of alumina produced for the refining process [66]. Moreover, over 1,336,249 TJ of fuel energy was used worldwide for refining alumina. This figure is underreported as the figures only take into account 94% of the world's refiners that contributed data [67]. In order to get this energy power needs to be generated. Figure 8 shows the proportion of fuel sources used to generate power for the primary industry in Europe.

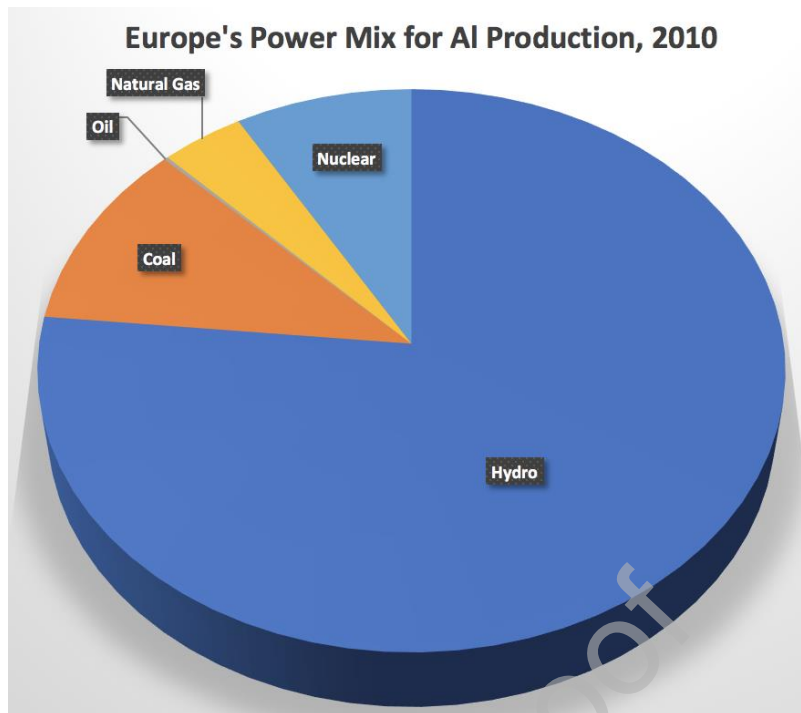

Figure 8: The proportions of technology used to develop electrical power for Europe's primary aluminium smelters, 2010. Developed from data provided within [63].

3.3. Eutrophication Potential

Eutrophication or hypertrophication describes how compounds can affect water quality, particularly oxygen depletion, by causing extreme plant growth, such as algal blooms [68]. Typical causes are nitrogen and phosphorous in water courses and the unit used to describe eutrophication potential is expressed as phosphate equivalents. Even though the units are phosphate equivalents, NO_x emissions are responsible for 95% of eutrophication potential from the US primary industry, with 4% coming from nitrate emissions to water, 0.7% from NH_3 and phosphorus emissions. The total phosphate equivalent produced by the US is 2.35 kg of phosphate equivalent emissions per US ton of primary aluminium ingot produced with Figure 9 showing the emissions in each step of the process. [65]

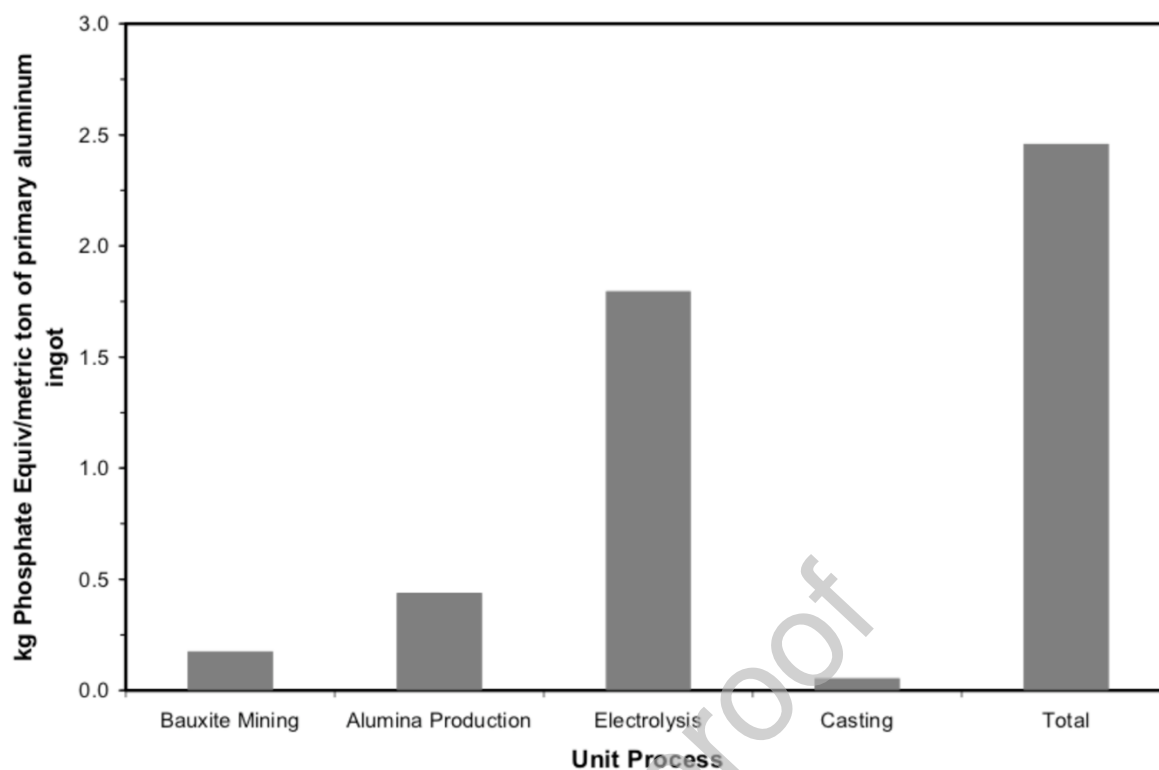

Figure 9: Eutrophication potential by process step, reproduced from [65].

3.4. Photochemical Ozone Creation Potential

Photochemical ozone creation potential (POCP) is a metric used to quantify emissions that can contribute to low level smog; the unit is ethene equivalents. SO_2 (59%), volatile organic compounds (VOC's) (19%), NO_x (17%) and methane (CH_4) (2%) contribute to this figure from the primary industry. This is a result of compounds like VOC's and NO_x reacting with ultraviolet light from the sun in the atmosphere. 3.06 kg ethane_{eq.} (C_2H_6) per tonne is produced. Roughly, 70% of these emissions come from electricity generation. Figure 10 shows the POCP emissions for each primary process step. [65]

A breakdown of POCP's for 75 different organic compounds that can be released from anthropogenic sources is provided by [69].

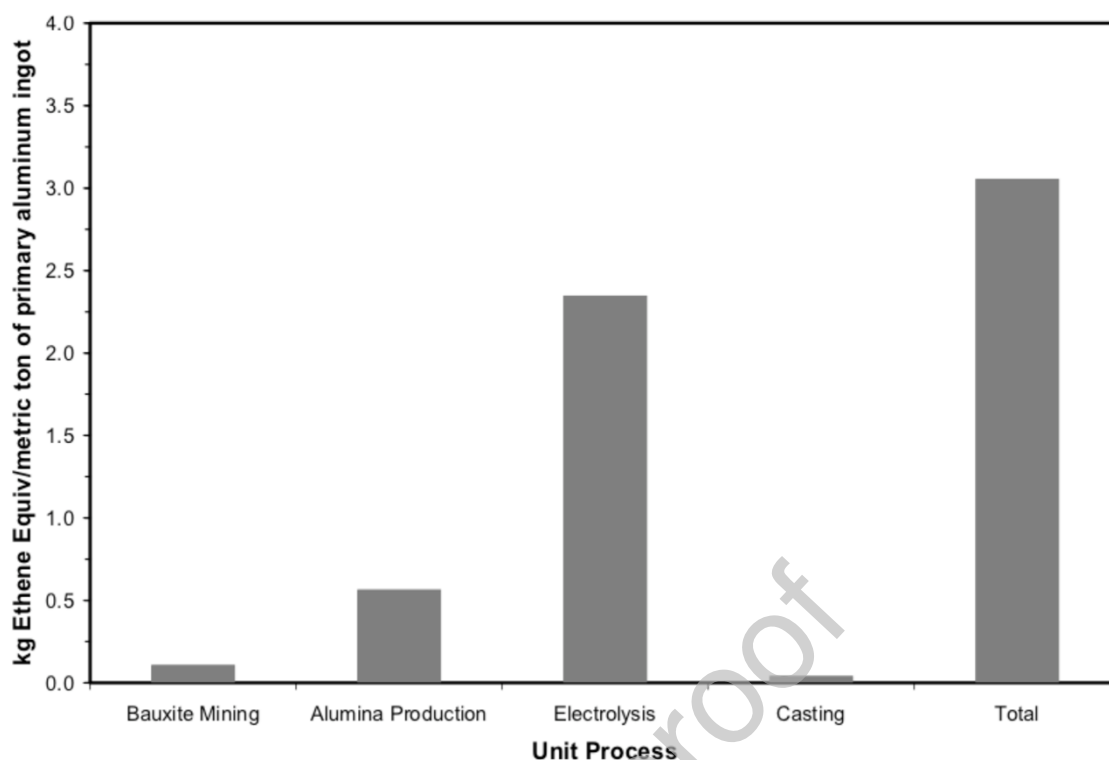

Figure 10: Photochemical ozone creation potential by process step, reproduced from [65].

3.5. Water Scarcity Footprint of Primary Aluminium

Water scarcity footprint (WSFP) is a measure of the environmental impact on the availability of water. With primary aluminium production, the cause can either be direct or indirect, direct being freshwater consumption from mining, refining and smelters, indirect being from ancillary materials, fuel and electricity. The main direct causes are from cooling water evaporation, direct discharge to the sea, water retained in bauxite whist shipping and then losses from the subsequent evaporation. WSFP has been calculated for global primary aluminium production as $18.2\text{m}^3 \text{H}_2\text{O}_{\text{eq.tAl}}^{-1}$ or $9.6 \text{m}^3 \text{H}_2\text{O}_{\text{eq.tAl}}^{-1}$ without the contribution of China, as the inclusion of China heavily affects the resulting calculations as a heavy user. [70]

3.6. Red Mud

The bauxite residue from the Bayer process is known as ‘red mud’ due to its distinctive colour. To put the quantity into perspective, roughly the same mass of red mud is produced as alumina from the Bayer process [39]. Historically, it has been disposed of completely in landfills but due to the volume and hazardous, high-alkalinity nature, researchers have been looking into treating red mud as an infeed material to produce products with some value. The following references provide the most comprehensive research to date on the composition [39,71] and potential uses for red mud: alkaline recovery of Aluminium [40]; concrete [72]; geopolymers [73]; gallium extraction [74]; ceramic tiles [75]; the calcification-carbonation method to recover alumina and NaOH [76]; road bases [77,78]. Each method is not an all-encompassing solution and some struggle to be economically advantageous.

3.7. Spent Pot Lining

Another difficult waste to deal with arising from the primary industry is the end of life reduction cell cathode walls. After roughly 5 years of operation, the lining of the cell walls becomes expended hence ‘spent pot lining’, known as SPL. 20-50 kg of SPL is produced per tonne of aluminium. SPL consists of two discrete fractions, a high in cathode portion and a high in refractory portion (silico-aluminous bricks). These are known as the first and second cut, respectively, with the first forming around 55% by weight. The difference in these is that the first cut contains mainly a carbonaceous cathode and the second cut contains the insulating materials used to minimise heat loss through the pot walls. SPL is deemed a hazardous waste and millions of tonnes are generated annually and disposed of in landfill. The main issues presented are contamination of groundwater and soil, gaseous emissions and biological destruction. Along with refractory and carbon, it can contain metals, nitrides, hydroxides, cyanides, carbides, carbonates, among others. Table 3 shows the typical composition of SPL for three different cell smelting technologies. Studies have been aimed at treating SPL to prevent landfill and create a valuable product, for example, as an alternative fuel for the cement industry (which helps reduce NO_x emissions), an alternative fuel for primary iron production and potentially a flux in the nonferrous industry. [42,79]

Table 3: Composition of SPL, provided by [80].

Component	Technology Type A	Technology Type B	Söderberg Technology	Major Phases
Fluorides (wt.%)	10.9	15.5	18	Na ₃ AlF ₆ , NaF, CaF ₂
Cyanides (ppm)	680	4480	1040	NaCN, NaFe(CN) ₆
Aluminium total (wt.%)	13.6	11	12.5	Al ₂ O ₃ , NaAl ₁₁ O ₁₇
Carbon (wt.%)	50.2	45.5	38.4	Graphite
Sodium (wt.%)	12.5	16.3	14.3	Na ₃ AlF ₆ , NaF
Aluminium Metal (wt.%)	1	1	1.9	Metal
Calcium (wt.%)	1.3	2.4	2.4	CaF ₂
Iron (wt.%)	2.9	3.1	4.3	Fe ₂ O ₃
Lithium	0.03	0.03	0.6	Li ₃ AlF ₆ , LiF
Titanium (wt.%)	0.23	0.24	0.15	TiB ₂
Magnesium (wt.%)	0.23	0.09	0.2	-

3.8. Gaseous Emissions

The Bayer process requires roughly 12.8 MJ.kg⁻¹ of energy and produces 0.83 kg of CO₂ for each kg of alumina refined [41]. Part of this energy is consumed during the calcination process. It has been reported that for producing each kg of alumina calcined from Gibbsite at 1100°C, 4.13 MJ of energy consumption is required, 0.28 kg of CO₂ is produced with an exergy efficiency of 9.45% [41].

An environmental impact analysis of primary aluminium production, using 2012 data, was conducted with a life cycle assessment study [81], shown in Figure 11. The Figure shows the

theoretical global warming potential (GWP) and CO_{2eq.} emissions per kg of molten primary aluminium produced for 29 countries for each industry. Surprisingly, South Africa was the worst performer as it generates its electricity predominantly from coal (92%). However, as South Africa only produces a fraction of what China is capable of (c. 46% of world production [81]), China is still by far the largest offender for emissions.

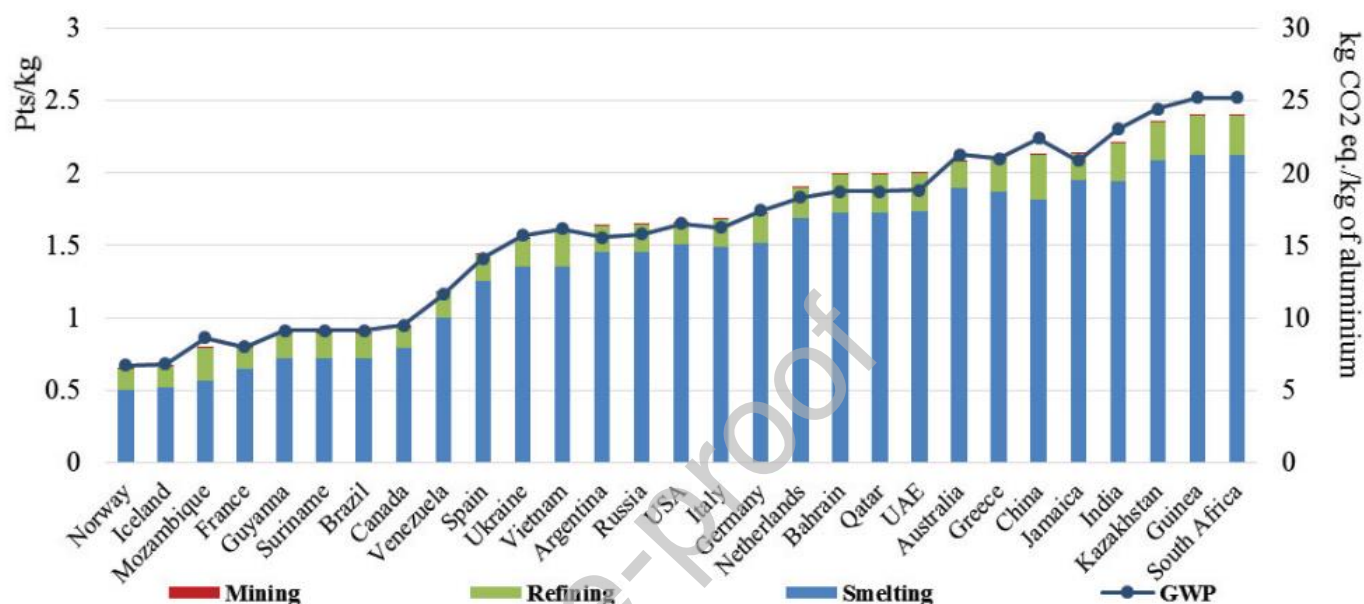

Figure 11: Graph showing the theoretical CO_{2eq.} emissions of each country by industry. Reproduced from [81].

Between 400-450 kg of combined carbon from the anode and cathode is consumed [82] and 150 kg of CO₂ is released from the anode for each tonne of primary aluminium produced [33]. Theoretically, the value of consumed carbon should be closer to 334 kg.t⁻¹ [82]. Staggeringly, every kg reduction in net carbon consumption from a primary aluminium smelter could save \$450,000 per annum [82]. Furthermore, literature states that to re-melt and recycle secondary aluminium requires between 5-10% of the energy required to produce primary metal [11,49]. Recycling aluminium has been calculated to reduce CO₂ emissions by 90 Mt a year [54].

3.8.1. Perfluorocarbons

In 2018, the primary industry released 35,706 kt CO_{2eq.} of perfluorocarbons (PFC's), compounds with only carbon and fluorine atoms, which equates to 0.55 t CO_{2eq.} for every tonne of Al produced [83]. In this case, tetrafluoromethane (CF₄) and hexafluoroethane (C₂F₆) are produced. They have a CO_{2eq.} factor of 5,100-6,500 and 9,200-10,000, respectively [41]. These compounds are formed as a result of the 'anode effect'; they are non-toxic to humans but aid in stratospheric ozone depletion and are highly stable, lasting for more than 10,000 years. To date, there have been no identified natural sources and the major anthropogenic source is smelting alumina [84]. When alumina levels drop because of poor process control, the carbon anode reacts with cryolite (the anode effect), shown by Equations 5 and 6, adapted from [84]. Recognition as to the hazard of PFC's has meant that the anode

effect frequency in the most tightly controlled pot-rooms has dropped to 1 occurrence every 10 days per cell with others reporting 1-3 times per day per cell [84].

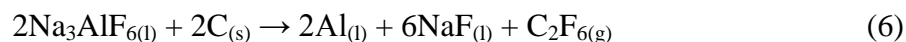

Three methods are used to control the release of perfluorocarbons: automatic anode effect suppression, feeding alumina at multiple points and introducing computer aided controls to monitor the electrolytic process and operating parameters and to adapt them when unfavourable conditions are seen. [42]

3.8.2. Hydrogen Fluoride

Another by-product released into the atmosphere during the primary process is hydrogen fluoride (HF) gas. In 2018, 37 t of fluoride was emitted, 0.56 kg per tonne of aluminium [85]. These gases are primarily produced within the reduction cells from hydrolysis reactions. The hydrogen for these reactions comes from three main sources: structural and adsorbed water in alumina, hydrogen within the anode and ambient humidity [86]. A further source of HF is from the anode baking process, described later. A Packed Bed Filter (PBF) has been developed and patented by LTB that abates HF emissions during anode baking by passing the gases through limestone in a silo. The HF reacts with CaCO_3 to produce CaF_2 , CO_2 and H_2O . After this PBF, emissions of HF are less than $1\text{mg}\cdot\text{m}^{-3}$ from an inlet concentration of 35-70 $\text{mg}\cdot\text{m}^{-3}$ STP [87]. HF is also produced in the secondary industry. Using lime injection into emissions from furnaces reduces emissions of HF to less than 0.1-2.5 $\text{mg}\cdot\text{Nm}^{-3}$ [42].

3.8.3. Polycyclic Aromatic Hydrocarbons

Polycyclic aromatic hydrocarbons (PAH) are compounds made of carbon and hydrogen that are aromatised in two or more rings. They are formed from incomplete combustion, from the Söderberg plants during electrolysis from the anode and during anode baking for prebake cells [42]. Many are toxic to aquatic species even at low exposure levels and some are carcinogenic [88]. The average PAH emissions produced across a sample of six primary smelters, for a duration of four years, was $0.638\text{ kg}\cdot\text{t}^{-1}$ of primary aluminium produced. Of this, $0.28\text{ kg}\cdot\text{t}^{-1}$ was emitted to air with a proportion also discharged to water. The main constituent PAH was phenanthrene, averaging 66%. [89]

New environmental concerns and targets for Polycyclic Aromatic Hydrocarbon emissions mean new technology is being developed for treating fumes from anode production plants. These includes regenerative thermal oxidisers (RTO's) that thermally treat the emissions to ensure complete combustion [87].

3.8.4. SO_x

Sulphur emissions in the form of SO_x are also a concern during the anode baking process. There are European limits of 200 mg.m⁻³. The precursor for these emissions come from its presence in the raw materials used to produce the anodes (pitch and coke) and also from the fuel source [87]. SO₂ emission can be reduced by producing anodes from coke and raw materials with less sulphur content as coke is responsible for 85% of sulphur introduced to the process. Sulphur content cannot be completely removed as it is required to control certain characteristics of anodes [42].

3.9. Dross and Salt Slag

White dross forms on top of holding furnaces in cast houses not using salt fluxes. It is created from surface oxidation of aluminium reacting with water. It is scraped off the top throughout the process and contains a high proportion of entrapped metallic aluminium (up to 45%), which is re-melted. Black dross forms as a layer on top of furnaces in the secondary industry melting furnaces when using salt fluxes. The characteristic colour is due to contamination within the melted scrap mixing, aluminium oxide and salt. The typical metallic aluminium content is 10-20% of its composition [37]. This layer is removed prior to casting. The dross layer is exposed to the hottest temperatures in the furnace, coming directly into contact with the burner combustion air and as such is extremely hot when removed. However, it takes a long time for this material to cool as it reacts exothermically, propagating a reaction and reducing the valuable aluminium content. This is referred to as 'thermiting' in the industry. Traditionally, this material was left to cool, releasing all the heat to atmosphere and then landfilled.

It is commercially viable to recover aluminium from black dross. Once the aluminium recovery process is completed there is residual salty oxide product, known as salt slag or salt cake. Salt slag is classified as a toxic and hazardous waste. It is composed of Al, Al₂O₃, magnesium spinel (MgAlO₄), magnesium oxide/ periclase (MgO), silicon oxide/ quartz (SiO₂), the used salt flux, carbides and nitrides [90]. It is considered highly flammable, an irritant, harmful and leachable [91,92]. As such, its disposal is a global challenge. The main challenges include the formation of potentially dangerous and harmful gases, predominantly ammonia (NH₃) but also methane (CH₄), phosphine (PH₃), hydrogen (H₂) and hydrogen sulphide (H₂S) [37]. Another challenge is the release of metal ions and other ions leaching into and polluting groundwater [37]. However, this material still contains a proportion of alloyed aluminium (3-10% [93]). Much work has been done to create a commercial product out of this material, for example a fluxing agent in the steel industry [94]. Others research is summarised by [90].

4. State of the Art Equipment and Sources of Waste Heat

When using fuel-fired heating equipment, energy loss is unavoidable. A major form of energy loss is waste heat. The mixture of fuel and air (sometimes enriched oxygen) is burned to release chemical energy as heat. This is used to transfer heat to the desired load [95]. This

section deals with the typical technologies and equipment used in aluminium industries. Equipment and technology for mining bauxite have been omitted as opportunities for heat recovery technologies is of a lesser significance. Technology with the ability for WHR is the primary focus, although some of the equipment provided has little ability for WHR but has been added to give a fuller picture of the state of the art.

4.1. Primary Industry

An in-depth study was conducted at the primary smelter Alcoa Deschambault Quebec in Canada [28], which produces *c.* 260,000 t_{Al}.yr⁻¹. The authors found that around 7.7 MWh.Mt⁻¹ of exergy was destroyed throughout the plant and the largest source of exergy destruction was from the exhaust gases, 0.57 MWh per tonne of aluminium produced. Figure 12 and Figure 13, energy and exergy diagrams, respectively, show the sources and quantities of losses for the reduction process.

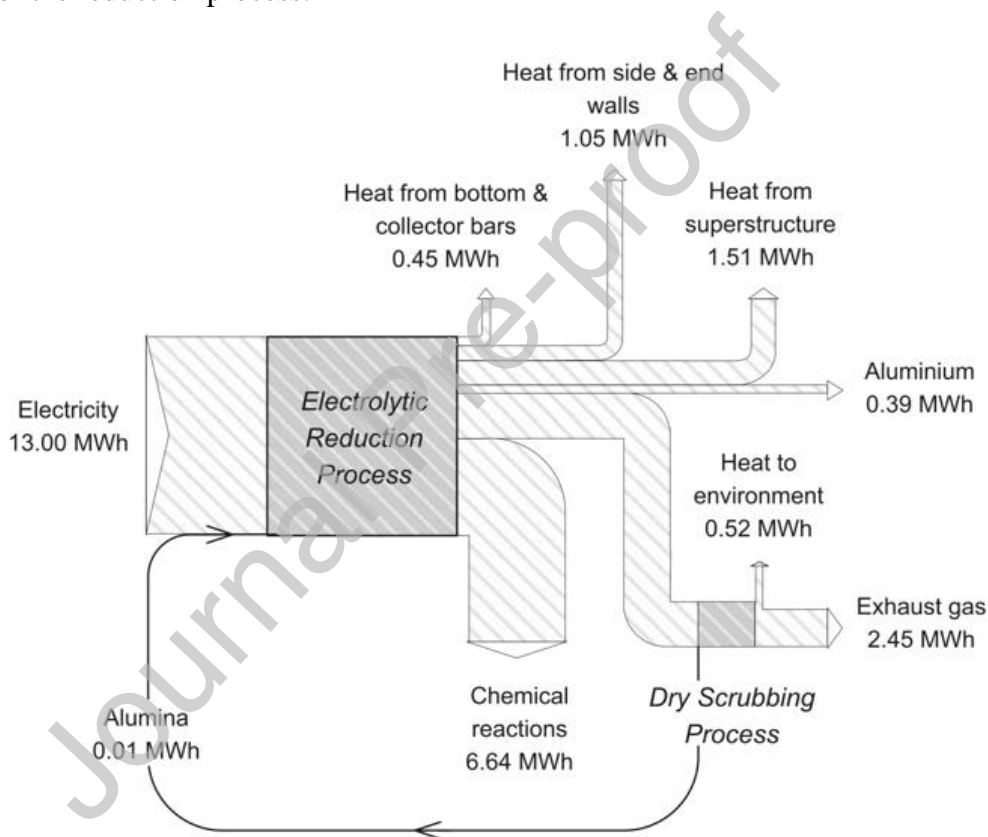

Figure 12: Sankey diagram for the reduction process, reproduced from [28].

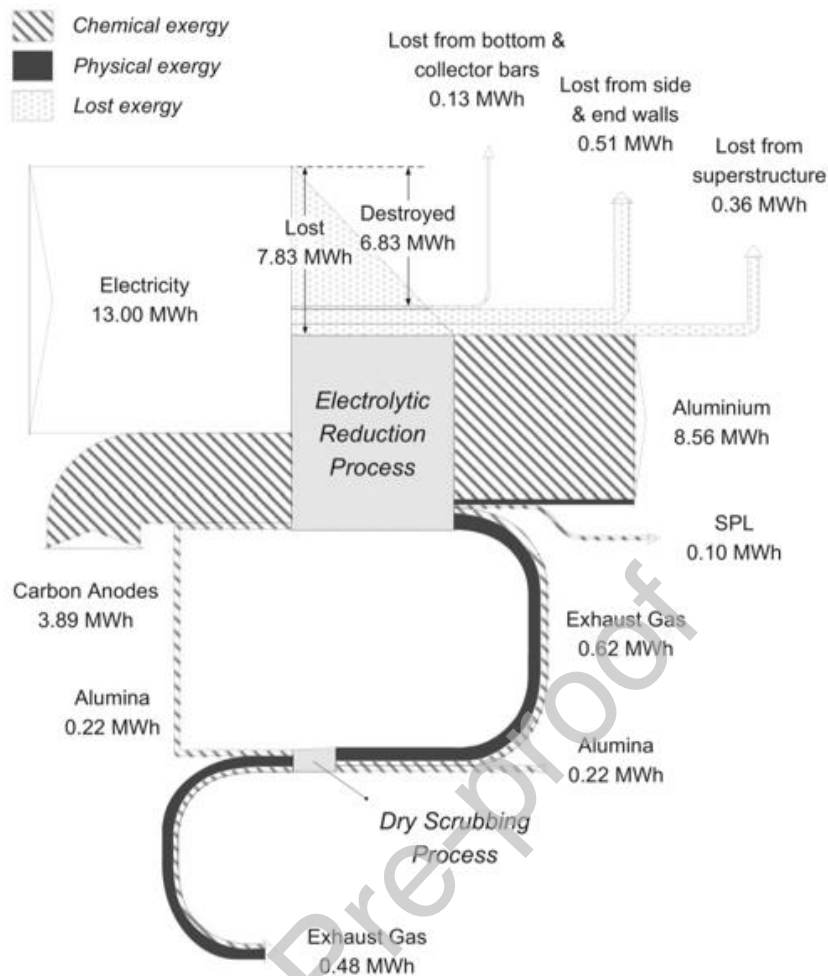

Figure 13: Exergy balance diagram for the reduction process, reproduced from [28].

4.1.1. Electrolytic Reduction Cell Pots

Even though the electrolytic cells are classified into Søderberg and Prebake cells, these have different types. For example, you can have point feeder, centre-break and side-break prebaked anode cells and vertical or horizontal stud Søderberg cells. In common, Søderberg cells have a continuous anode, where carbon material is added and is baked in-situ during operation. The anode production processes are described in the next section. The heat produced internally within the cell and the current passing through the anode bake the anode during operation. Conductive studs within the anode allow electric current to pass through the anode. As the anode is consumed, these studs are withdrawn higher up the anode and more unbaked anode is added to allow continuous operation. Alumina is periodically added into the cell. This is done by breaking the surface crust that builds up on top of the molten aluminium bath. Newer plants do not require the need to break the crust as they use automatic point feeding systems. As gas is produced, it passes through burners to try to reduce emissions prior to a gas treatment centre (GTC). [42]

Prebake cells (Figure 14) use premanufactured and baked carbon anodes that require replacement when spent [31], typically after four weeks [96]. There are multiple anodes (12-

40) to pass electric current that are steadily lowered into the bath as the anode is consumed. Table 4 provides a comparison between the two technologies.

Table 4: A comparison between Prebake and Søderberg cell technology, adapted from [42].

Parameter	Søderberg	Prebake	Unit
Alumina required	1910 – 1960		kg.t ⁻¹
Anode consumption	470 – 530 (paste)	410 – 450	kg.t ⁻¹
AlF ₃ introduced	18 – 25	13 – 30	kg.t ⁻¹
Cathode lifespan	4 – 6	5 – 8	years
Operating current	40 – 400		kA
Electrolysis energy consumption	14.5 – 17.0	13.2 – 15.0	kWh.kg ⁻¹
Electrical power required including auxiliary consumption	15.1 – 17.5	13.6 – 15.7	kWh.kg ⁻¹

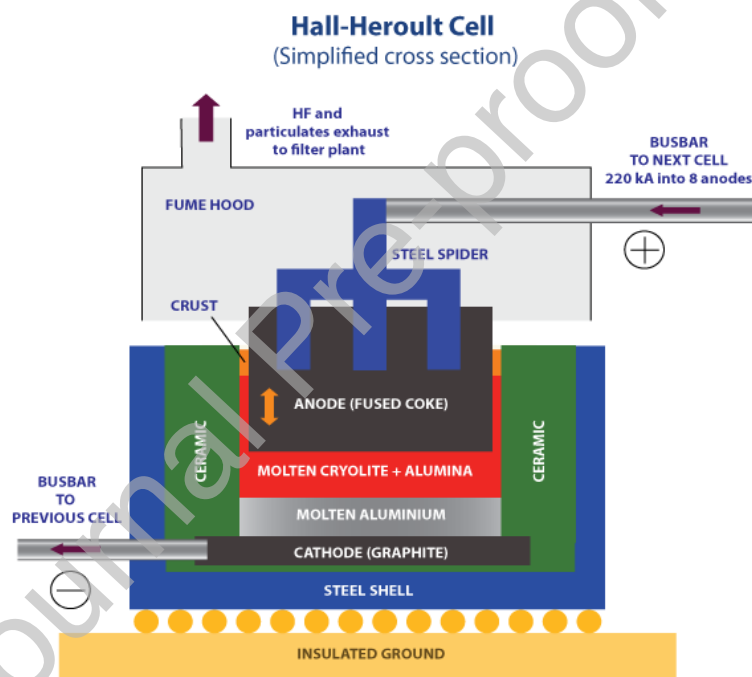

Figure 14: A schematic example of a Prebake Hall- Héroult reduction cell. Reproduced from [97].

Up to 1% of energy input is lost through off gases from the 264 reduction cells in the Alcoa Deschambault Quebec smelter. Around 40 MW is lost through the exhaust gas but end uses and recovery technology are limited due to being only around 100°C above ambient [98]. However, the largest proportion of losses is through the sidewalls, up to 45% of energy input. Heat loss here is high when compared to other furnaces, though this is, in part, intentional. Molten cryolite is corrosive so conditions in the cell are designed and maintained to keep the cryolite adjacent to cathode solid. [99]

4.1.2. Anode Production

As described, anodes and cathodes are needed in order for the electrolytic reduction inside a pot to occur and the anode reacts with oxygen liberated to form predominantly CO₂ (Equation

7). Other smaller side reactions occur, like the Boudouard reaction (Equation 8), where CO_2 reacts with the carbon present to form carbon monoxide (CO). Equations adapted from [82]:



An entire industry is devoted to making these anodes, with most smelters having a dedicated carbon anode production plant on site [42]. ‘Green Paste’ is the name of the unfired precursor anode mixture. The mixture is variable depending on the cell type it is being made for. For prebaked anodes, it is formed from blending molten coal tar pitch (15%), calcined petroleum coke (65%) and recycled spent anode butts (20%) [100]. After briquetting, the green paste is used ‘as is’ with Søderberg cells. With prebaked cell technology, the green paste is shaped into a ‘green anode’ by vibro-compaction or moulding [101], and baked in a ring furnace at temperatures of 800-1200°C [100,101] and the temperature profile is ramped at approximately 10-14°C.hr⁻¹ (no more than 15°C.hr⁻¹ to prevent cracking [102]).

Consequently, the process takes a significant period of time with much opportunity for heat recovery. In addition, it has been reported that in well maintained furnaces 3000-5000 Nm³ of waste gas is produced for each tonne of anode, with poorly maintained or operated furnaces the figure is up to 7000 Nm³ per tonne [102]. It is critical that the anodes are of high quality to be commercially viable. Important characteristics include mechanical strength, electrical resistivity, density, permeability and thermal shock resistance [101]. To this extent, there have been a significant number of studies conducted on modelling and assessing energy efficiency of anode baking furnace designs [103–114]. From an example given for a typical production plant of 170,000 t capacity, an estimation of energy demand requirement is 2.5 GJ per tonne of anode for the baking furnace. Others have reported energy demands of 2 GJ [103]. There are two types of ring furnaces used to bake the green anodes, the open top furnace with a horizontal flue (Figure 15) and a closed top furnace with a vertical flue.

Although anode baking furnaces are large emitters of heat, no experimental studies have been done to quantify the amount of extractable heat. Gas from these furnaces have a large particulate load and requires treatment. The gas is released from the furnaces varies depending on where it is released but can be up to 1200°C. The top of the baking furnace also releases a lot of heat energy depending on the furnace section. Top surface temperatures between 100-1100°C are seen with an average of 700°C. For Alcoa Deschambault Quebec’s anode baking furnace, exhaust gases with 36 GWh of energy content is released per annum, 4.1 MW of continuous heat. It is calculated that 2 MW of heat could be extracted from this source. There are 2.7 MW of continuous heat lost from walls, 24 GWh a year. The authors of this study highlight how furnace designs would need to be changed in order to recover the heat effectively, for example having converged exhaust ducts. [98]

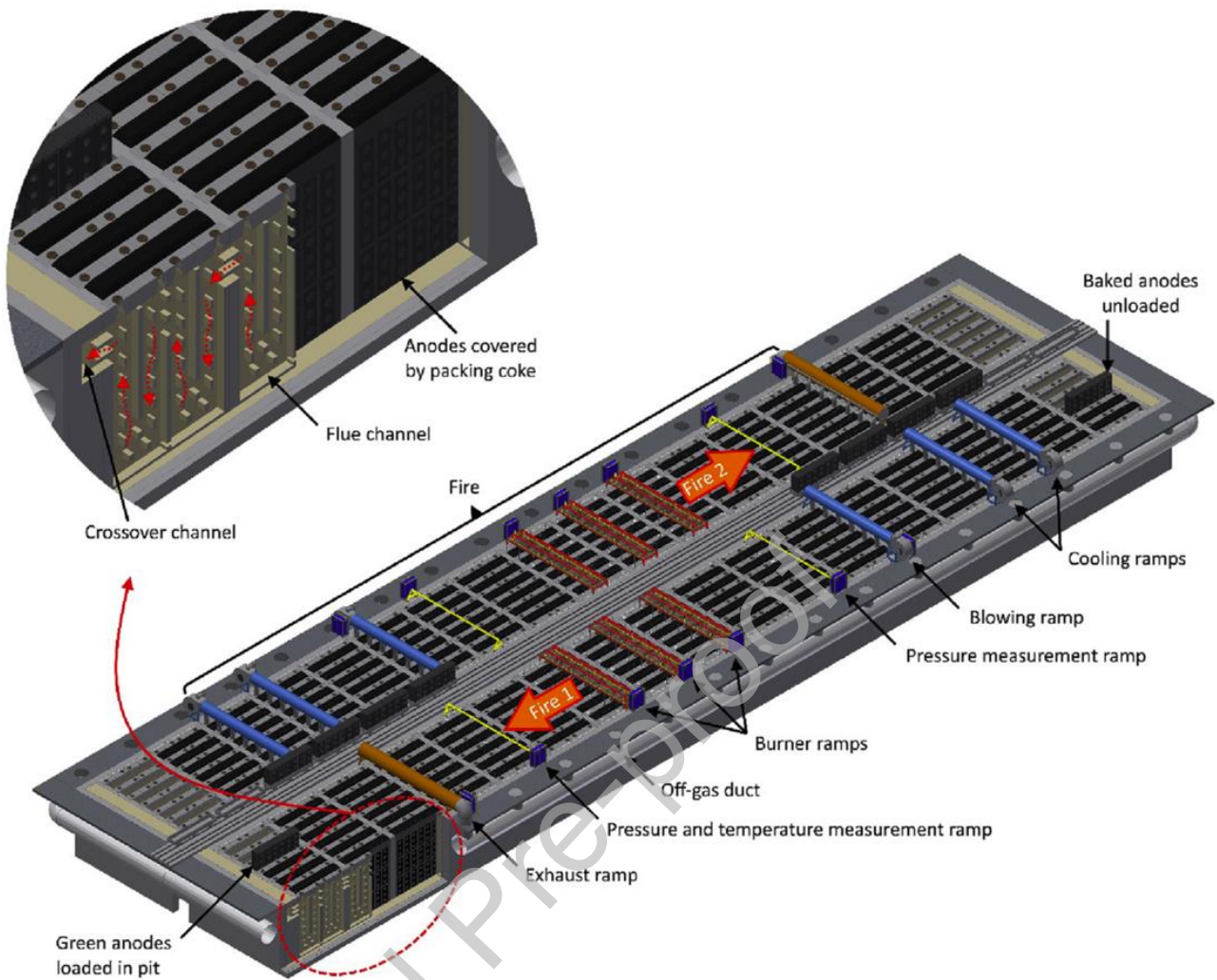
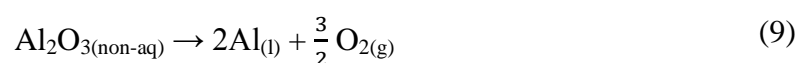

Figure 15: An open top horizontal anode baking furnace. Reproduced from [101].

4.1.2.1. Inert Anodes

A novel, industry changing concept being heavily invested in within the primary industry is that of inert anodes. This concept was originally introduced in Charles Martin Hall's 1886 patent. The aim is to reduce formation of CO_2 to produce primary aluminium in a more environmentally friendly manner. The inert anodes have been developed to replace the carbon anodes currently used in the primary reduction cells. The primary companies Alcoa and Rio Tinto along with the Governments of Canada and Quebec have developed inert anodes in a project called Elysis, and UC Rusal but they are yet to be proven commercially viable and there are still issues with metal purity and anode wear [33]. Rusal aim to have a commercial product by 2021 and Alcoa with Rio Tinto offering the technology by 2024.

The inert anodes are not carbon and do not produce CO_2 by reacting with oxygen (seen in Equation 7) but instead generate pure oxygen during the reduction process, eliminating GHG emissions. The ideal reaction for an inert anode is shown in Equation 9 [115]:



Ideal properties have been best described by [116]. Highlights include high electrical conductivity, resistance against fluoridation, high chemical stability against oxygen at 1050°C, high mechanical strength, retrofittable in the present cell design and low cost. Research has highlighted the following types of anodes as possibilities, abridged in Table 5, updated from [115]:

Table 5: A table of available literature on inert anodes by their type and group.

Group	Anode Type	Reference
Ceramic	NiFe ₂ O ₄	[117], Doped with V ₂ O ₅ , MnO ₂ , TiO ₂ [118].
	SnO ₂	Doped with Sb ₂ O ₃ , CuO, ZnO, Fe ₂ O ₃ [119], [120].
	NiO-Li ₂ O	[121]
Metals	Aluminium Bronze	[122] with Ni and Fe additions.
	Cu-Ni-Fe	[123–126]
	Ni-Fe, Ni-Co Coating	[123]
Cermets (ceramic and metal)	Fe-(NiFe ₂ O ₄ + NiO)	[127,128]
	17(Cu-10Ni)-(NiFe ₂ O ₄ -10NiO)	[129]
	NiFe ₂ O ₄ -Cu	[130]
	Cu ₂ O-Cu	[131]
	Ni(NiFe ₂ O ₄ -10NiO)	[132]
Unconventional	Solid oxide fuel cell	[133]
	Bipolar electrodes	[134]
	Depolarised gas anode	[135]

4.1.3. Carbon Capture

Carbon capture technology aims to selectively remove CO₂ from process streams to avoid emissions to atmosphere. New developments have been made in regard to carbon capture technologies that can be applied to the primary smelting industry. This technology will be particularly important to develop if proven economically feasible and especially if inert anode technology proves unsuccessful. Preventing CO₂ production initially would prove this technology redundant as applied to the electrolysis cells, but electricity generation still provides the largest proportion of CO₂ footprint, up to 13.60 kg of CO_{2eq.} emissions per tonne of aluminium produced if coal-fired power is used [136]. Though carbon capture systems are not currently applied to the aluminium industry, many feasibility studies have been conducted [136–138].

With carbon capture technology, up to 95% CO₂ gas is initially absorbed by a solvent and then desorbed. The solvent is sent back to absorb more CO₂ and the CO₂ desorbed is stored and can be up to 98% pure [136]. Typical CO₂ concentrations in exhaust gas from primary process sources are around 1-1.5% by volume [136]. It has been shown by two studies that a concentration of 4% volume of CO₂ allows the highest capture rate [137] and most economical configuration [136]. This would mean the design of the electrolysis reduction cells would need modifying without altering working conditions. The two most prominent

types of carbon capture plant available use either the solvent Monoethanolamine (MEA) or NH_3 . The most economical approach depends on the concentration of CO_2 . MEA-based plants are most efficient at CO_2 concentrations of 3-4% and NH_3 -based at concentrations of 7-10%. It has been recognised that to be commercially effective, heat recovery systems need to be integrated into these carbon capture systems. [138]

4.2. Refining Industry

Like the Hall-Héroult process, the overall principles behind the Bayer process of refining bauxite has not changed drastically since its conception. However, different equipment has been developed and introduced over the years to increase energy and process efficiency and also to increase alumina recovery [139]. There are various practises used in the Bayer method, particularly during digestion. These include split stream, single stream with steam injection, single stream tube digestion and double digestion [140]. A selection of energy intensive equipment found within the refining industry with the possibility for WHR is given below.

4.2.1. Digestion and Cooling

After mining and prior to shipping, bauxite is dried to minimise transporting water weight. The dried bauxite can then be ground using ball or rod mills. This is done to increase surface area to maximise alumina extraction but also to make the material pumpable [42]. Pre-desilication occurs and recycled NaOH is introduced. The slurry is pumped at around 100 bars at 100°C from the desilication process and sent to a preheating section that uses recovered steam to raise the temperature of the slurry. This can be done by using shell and tube preheaters where flash tank exit vapour is used to preheat the slurry prior to sending it to digestion furnaces, which heat the solution to the final desired temperature (around 270°C). Digestors (Figure 16) are used as a reaction vessel for the heated ground bauxite and sodium hydroxide solution where it is allowed a set retention period at a steady temperature. [141]

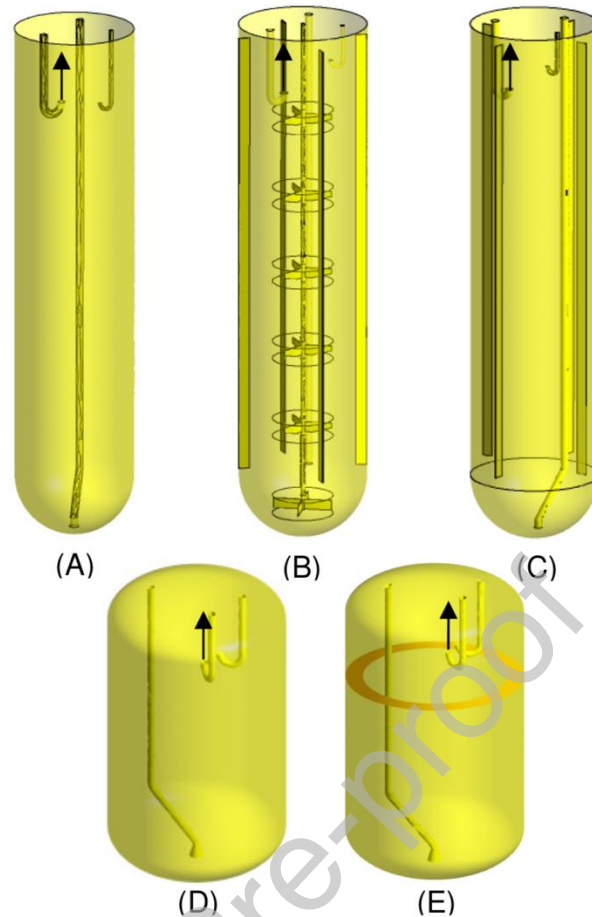

Figure 16: Five diagrams of digestors designs. (A) Base column, (B) Agitated column, (C) Baffled Column, (D) Base tank, (E) Baffled tank. Reproduced from [142].

Flash tanks are used to cool down and depressurise the slurry to atmospheric conditions prior to filtration. They are also a main area of heat recovery. Superheated steam is released from the slurry as the pressure reduces and this is sent to preheat incoming materials. Multiple flash tanks can be used depending on the bauxite the plant is processing and the temperature profile of the slurry, but 3-12 units is typical. Multiple designs of these tanks have been developed over the years and they include side entry, bottom entry and central inlet annual discharge flash tanks (Figure 17). [140]

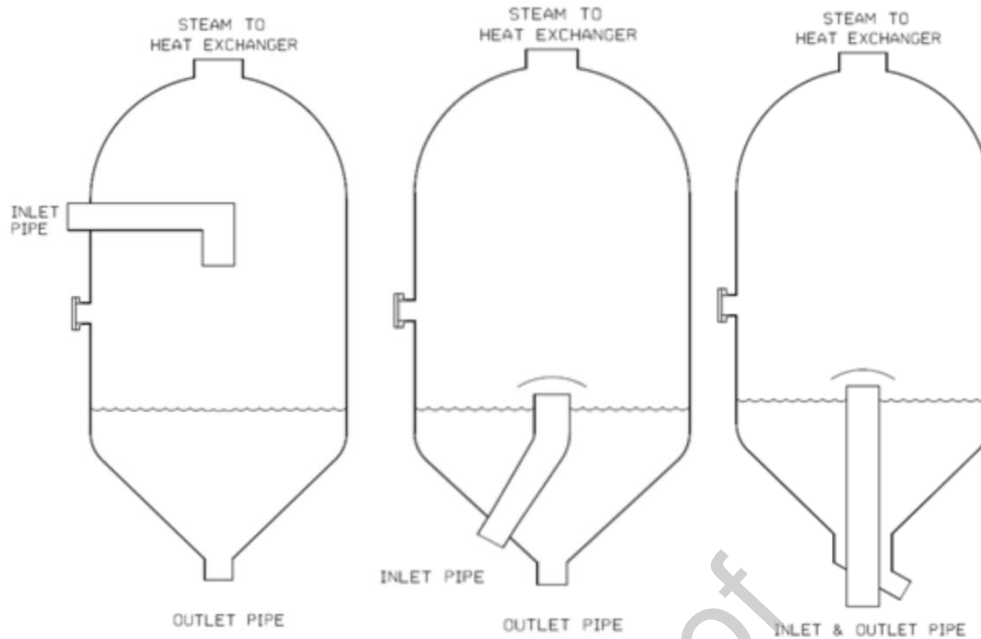

Figure 17: Three examples of flash tank designs, taken from [140].

The refining industry is very proactive at reusing waste heat streams during digestion but increasing heat exchanger efficiency is an avenue that would very beneficial.

4.2.2. Calcination

After digestion, the alumina is separated from red mud and requires calcining. The main three calcining technologies used today are rotary kilns, circulating fluidised beds (CFBs) and gas suspension furnaces. Rotary kilns (Figure 18) are a long steel tube lined with refractory with a direct firing burner. The material is fed counter-flow to the burner path and water is driven off. The material passes down the tube, which rotates to spread the material evenly and ensures good heat transfer.

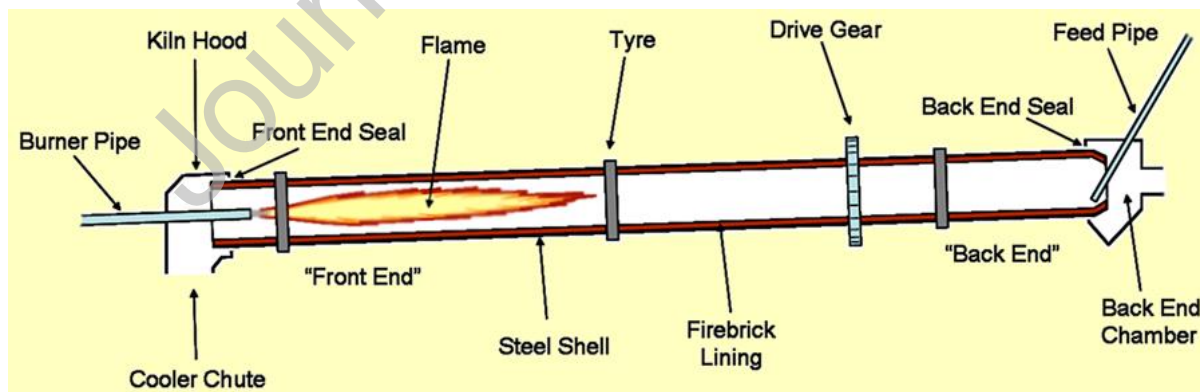

Figure 18: Schematic of a typical rotary kiln used to produce alumina [143].

CFB calciners (Figure 19) have greater energy efficiency, up to 95% [144], and produce a more uniform product and so are one of the options for new installations. They were invented in 1961 and the introduction of these cut *c.*30% of energy usage compared to rotary kilns. It has been reported that these can have outputs of 4 kt per day of alumina and use around 3 GJ to produce 1 tonne of alumina. Aluminium hydroxide is fed into the base of the furnace.

Combustion air is passed through this infeed, which fluidises the particles, the high temperature causes water to be liberated. As the particles are heavily mixed with the combustion gas, there is a significant amount of heat exchange and the temperature inside of the furnace becomes intermediate between the solids and combustion gas temperatures. A cyclone then separates the solids from the gas and the solids pass through a seal pot to re-enter the furnace. This cycle creates a very uniform product that eventually leaves the calciner. [145]

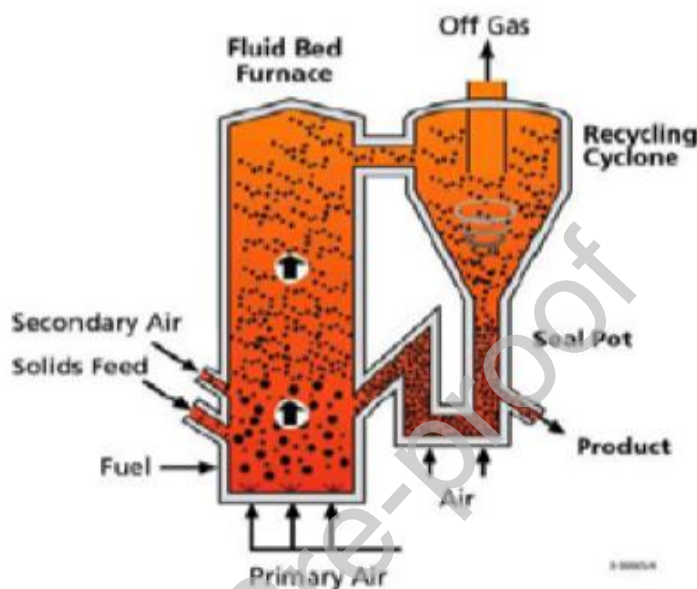

Figure 19: A multiple-pass circulating fluid-bed calciners, reproduced from [146].

Interestingly, the energy efficiency of these calciners is mainly attributed to preheating the incoming aluminium hydroxide [48] Figure 20 shows a flowsheet of the CFB calciners installed at Alunorte S.A, of which there are seven. The aluminium hydroxide (hydrate) is preheated and partially dehydrated in preheating stages I and II by exhaust gases. Using this technology over rotary kilns and preheating the infeed has reduced specific energy consumption by around 2.8 MJ.kg^{-1} of alumina. However, exhaust gases are still release at $150\text{-}170^\circ\text{C}$ with one site losing approximately 0.77 GJ per tonne of alumina [144]. Continued use of rotary kilns should be reviewed by the refining industry as CFB's are a clear advancement in technology. [145]

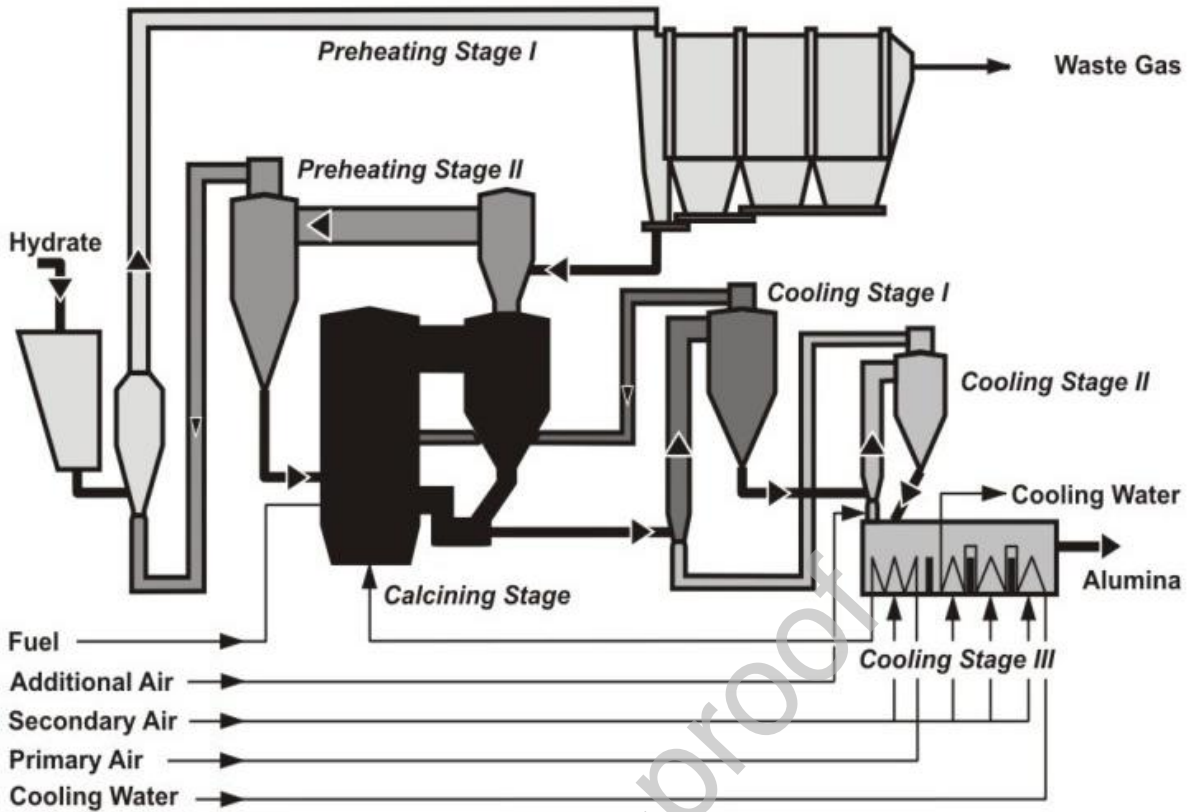

Figure 20: Alunorte S.A CFB calcining flowsheet, taken from [145].

Another type of calciner is a gas suspension furnace (Figure 21). Compared to the circulating fluid-bed calciner, the gas suspension calciner is a single pass operation with a low velocity ($5\text{-}7\text{ m}\cdot\text{s}^{-1}$) [146].

Table 6 shows the differences between typical circulating fluid bed and gas suspension calciner operating parameters. However, there are similarities. Both are direct drying methods burning fossil fuels, both use their exhaust streams to preheat the material infeed and the hot alumina is then used to preheat the combustion air for the burners [146].

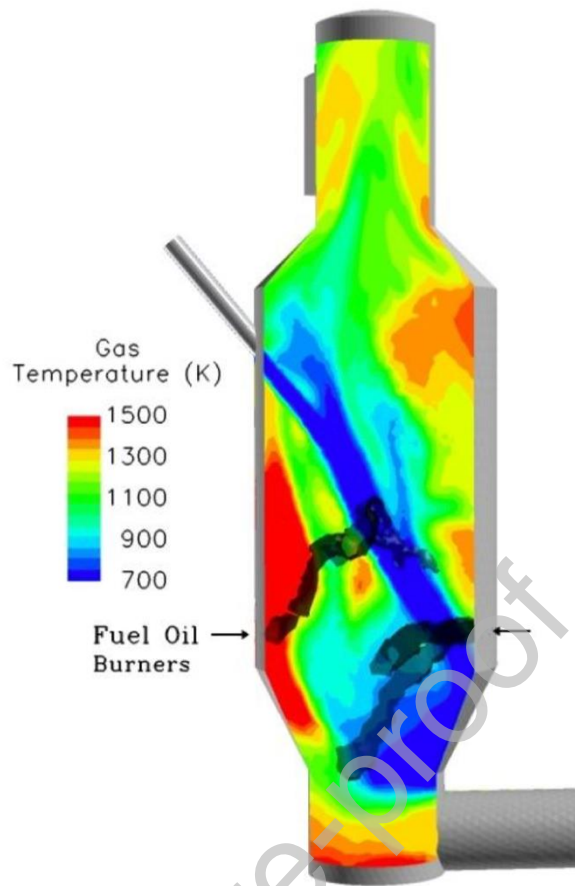

Figure 21: CFD model of the temperature profile within a gas suspension calciner furnace, reproduced from [147].

Table 6: Comparison between CFB's and GSC's operating conditions. Adapted from [146].

Parameter	Circulating Fluid-Bed	Gas Suspension Calciner with Holding Vessel	Gas Suspension Calciner without Holding Vessel
Temperature/ °C	950	< 960	1050
Pressure/ kPa	> 101.3	< 101.3	< 101.3
Retention time	3-5 mins	≥ 200 s	10-12 s
Capacity/ t.day ⁻¹	≤ 3500	≤ 3500	≤ 4500

4.3. Casthouse Technologies

4.3.1. Furnace Technology

There are many different furnace technologies in the aluminium industry, but they can be split into two distinct categories: fuel combustion and electric [11]. The varieties of furnaces used throughout the industry are described in this section. Of these, some are designed for melting aluminium and others are designed to hold molten aluminium prior to casting and so an analysis of the metal composition and alloying can occur i.e. melting or holding furnaces. Whether the furnace is a melting or holding furnaces is not mutually exclusive in the case of some furnace designs, but concessions have to be made on performance if they are not dedicated to a particular role. The fuel type depends on geographical location, resources available and scrap type melted. The fuel can be natural gas, LPG (liquified petroleum gas) or different weights of fuel oil. Over 75% of the energy used in the secondary industry is due to

the melting furnaces, which only have a thermal efficiency of 23-27.5%. Of this, 50-70% of the heat is released with the exhaust gas, reaching temperatures between 1100-1315°C [148]. Other main furnace losses include heat held within the refractory and steel structure, losses from the structure, radiated through openings, false air infiltration and incorrect stoichiometric burner ratios leading to excess air passing through the furnace [149]. These losses are best summarised by Figure 22. The efficiency of a furnace can be described by Equation 10, adapted from [95].

$$\eta = \frac{Q_p}{Q_c} \quad (10)$$

where:

η = Furnace efficiency, dimensionless.

Q_p = Heat energy embedded in final product, J.

Q_c = Heat energy supplied by combustion, J.

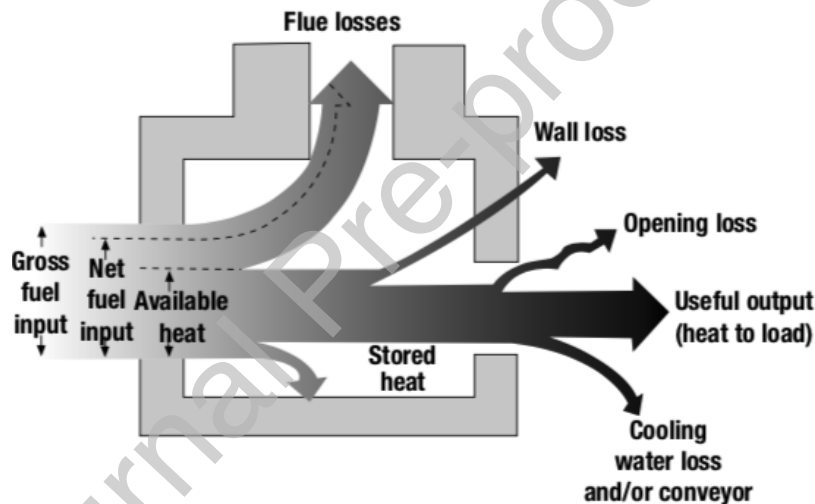

Figure 22: A Sankey diagram of energy loss from a reverberatory holding furnace [149].

As furnaces use hot gases to melt or hold the metal, the gas temperature will not decrease below the temperature of the metal, upholding the second law of thermodynamics. Therefore, the lower temperature limit of these gases will be the transfer temperature of the aluminium alloy. Accordingly, waste heat energy from the system will still correspond to around 40% of the energy input. In the US, only one third of melting furnaces employ WHR technology. [99]

4.3.1.1. Fixed Axis Rotary Furnaces

One of the most prevalent melting furnaces for the secondary industry is a rotary furnace [150]; a fixed axis rotary furnace is shown in Figure 23. Rotary furnaces are the main technology used for recycling dross [90]. It is a refractory brick lined steel shell that rotates using friction driven wheels, a chain or gears. Scrap is introduced into the front of the furnace and material is removed through a tapping hole that is blocked during operation with a foundry sand plug. An internal burner fires and heats up the refractory brick walls. The

refractory transfers heat to the charge by releasing its heat when rotating under the scrap or molten metal. It then is reheated when it emerges past the scrap and the cycle repeats. Rotary furnaces have been numerically modelled for heat transfer, fluid flow and temperature distribution in both 2D and 3D [151]. CFD has been undertaken to model aluminium scrap of different sizes melting in a rotary furnace using a salt flux [152]. The authors looked at heat transfer, fluid flow and natural gas combustion. It was found that the scrap size and shape had little influence on melting. Furthermore, the Taguchi technique (robust design method) has been implemented on a smelter using a rotary furnace to recycle aluminium in order to increase productivity [153]. Interestingly, the authors found that flux to metal ratio was the most critical variable in determining recovery, 91.1% of the recovery variation. Also, the most favourable conditions for good metal yield were low furnace temperature and high load weight and these were major contributors to metal yield variation. Unfortunately, many parameter variables were not investigated due to the difficulties that would have been faced collecting data or the uncertainties involved.

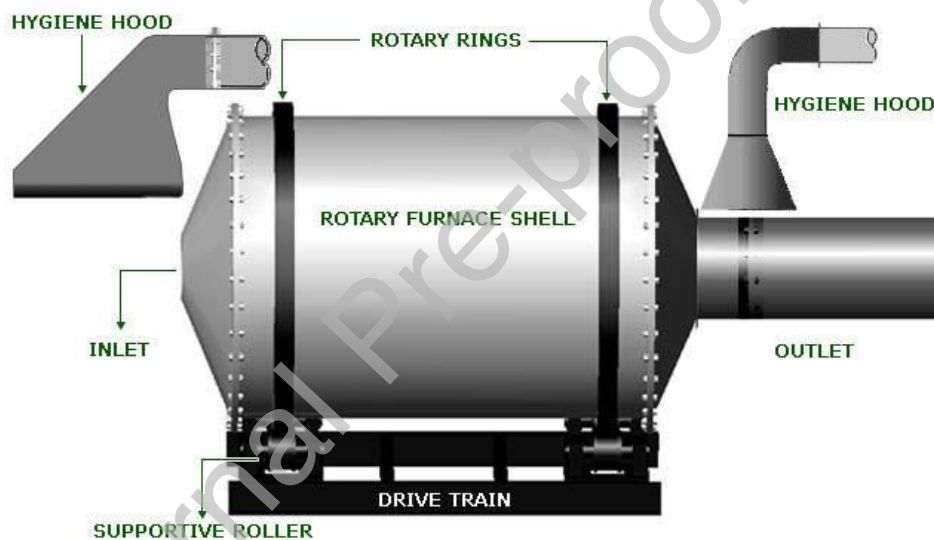

Figure 23: Diagram of a fixed axis rotary furnace, provided by [154].

4.3.1.2. Tilting Rotary Furnaces

The next generation of rotary furnaces for the secondary industry incorporated a hydraulic tilting mechanism rather than a tapping hole to release the metal and they are known as tilting rotary furnaces (Figure 24). Scrap is charged into the furnace, a door then covers the entrance and a burner that is attached to the door fires. Oxygen fuelled burners are commonly used with these furnaces though they can also be air fuelled. As with the rotary furnace, heat transfers to the charge by conduction from the refractory as it rotates and direct radiation from the burner combustion gas [155]. The scrap starts to melt, and more material can be added and sometimes a salt flux. An integral flue on the door directs away exhaust gases. When the charge is molten, the furnace lifts and the metal is directed to a holding furnace through a launder system for alloying or cast into a product, such as a sow. Advantages of tilting rotary furnaces over fixed axis rotaries and reverberatory furnaces include energy

savings (15%), increased metal recovery (3-5%), reduced cycle times (50%) and reduction of manual operations. [156]

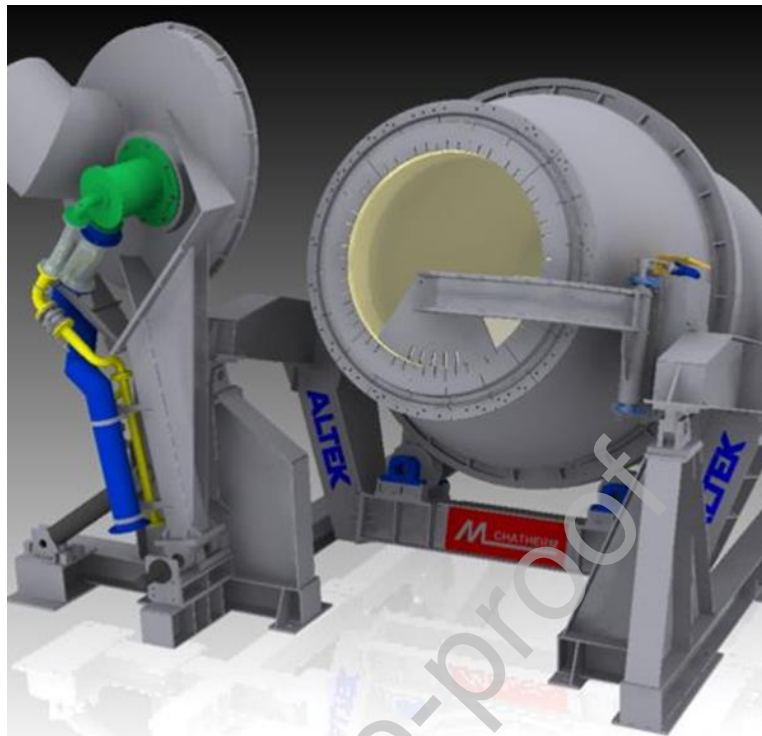

Figure 24: A typical tilting rotary furnace, provided by [157]. Installed at [53].

4.3.1.3. Holding and Alloying Furnaces

Holding furnaces tend to be a form of reverberatory furnace, they can be electric or gas fired and can be static or tiltable (Figure 25). Some consider gas-fired reverberatory furnaces to be the least efficient system for fossil fuels [158]. They hold metal at a certain temperature while minor elemental alloying and spectrography is completed to confirm elemental composition. They can also be used to raise the molten metal temperature to a sufficient casting temperature to avoid freezing while casting. Holding furnaces can be responsible for over 50% of energy used in die casting plants [159]. Reverberatory furnaces with capacities over 120 t are in operation [96].

Multiple papers have been published simulating holding furnace conditions on a small scale. [160] used computational fluid dynamics, response surface methodology and uniform design (CFD-RSM-UD). [161] used CFD to analyse the thermal performance and convection effects in an aluminium holding furnace. The authors noticed that CFD is not a methodology used in the design of industrial furnaces by manufacturers and state: ‘designs continue to be based on semi-empirical methods’. Further work can be done here to reduce fuel consumption.

Work has been undertaken aiming to reduce environmental impact by studying exergy transfer of an aluminium holding furnace by modelling a small scale electric furnace with a FeCrAl (iron-chrome alloy with aluminium covering) element, measuring exergy transfer by

conduction, radiation and convection during preheating and while holding liquid Al introduced at 930 K [162]. The authors found that most exergy transfer irreversibilities occurred in the resistance chamber and in the interface between a high conductivity refractory and insulating material layer.



Figure 25: A reverberatory furnace with tilting capability, taken from [163].

4.3.2. Electric Furnaces

Electric furnaces are an alternative to using fuel fired furnaces. These tend to be used for smaller operations with capacities typically between 160-4,500 kg [96]. As no combustion occurs, there is a much lower level of exhaust gases [51]. As oxygen isn't introduced into the furnace chamber within the combustion air, there is much less metal loss; 0.5-3% compared to 5-8% in fossil fuel furnaces [164]. Energy losses have been reported as 0.49-0.81 kWh.kg⁻¹ at 90% energy efficiency [96]. Unfortunately, as electricity tends to be more expensive than fuels, the cost benefit is reduced. Figure 26 shows a coreless induction furnaces and its parts.

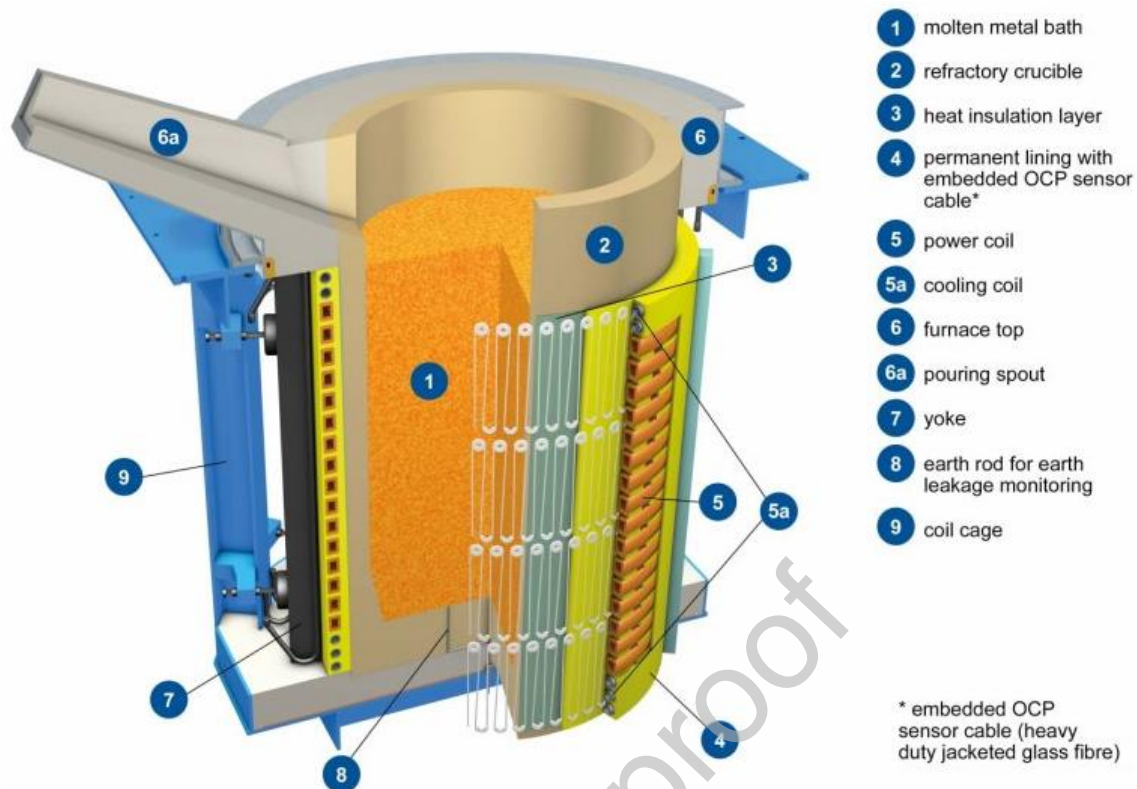

Figure 26: A coreless induction furnace with parts breakdown, provided by [165].

Further furnace technologies used include electric and gas crucible, channel induction, chip and swarf melting furnaces, de-ironing furnaces, single chamber melting furnaces, multi-chamber furnaces, top loading melting furnaces, shaft furnaces and heat treatment ovens. Table 7 shows an overview of the most common furnaces used in the secondary industry.

Consideration	Fixed Axis Rotary	Tilting Rotary	Single Chamber	Multiple Chamber	Channel Induction
Purpose	Melting	Melting	Melting/ Holding	Melting	Melting/ Holding
Preferred Feedstock	Scrap and dross	Scrap and dross	Ingots and scrap	Coated scrap	Ingots and scrap
Flux Usage	Y	< Fixed axis	N	N	N
Capacity, t	<150	<30	<180	<180	<50
Max melt rate, t.hr ⁻¹	20	7	30	28	7
Fuels	Natural gas, LPG, fuel oils	Natural gas, LPG, extra-light fuel oil	Natural gas, LPG, extra-light fuel oil	Natural gas, LPG, extra-light fuel oil	N/A
Waste Gas, 1000 m ³ .t ⁻¹ _{Al}	9-18	9-13	5-13	10-15	14.5

Table 7: A summary of typical secondary furnaces and emission, adapted from [42].

4.3.3. Casting Technology

The process of casting is directing or pouring molten metal into a mould and allowing the heat to dissipate, causing solidification of the metal in a desired shape. The molten aluminium is tapped from the furnace at normally over 720-750°C and directed to the casting machines through launder systems. The temperature is required to avoid solidification of the

aluminium prior to or in the launder system, causing dangerous spills. Various casting methods are described below.

4.3.3.1. Continuous Casting Conveyor

Continuous casting machines involve open top, usually cast steel, moulds on either a continuous conveyor chain loop or a rotating head (Figure 27). Molten metal is directed to the moulds using launder systems where the moulds are filled [166]. On some casting machines, the ingots are sprayed with water to solidify them, others allow enough time for the heat to dissipate.

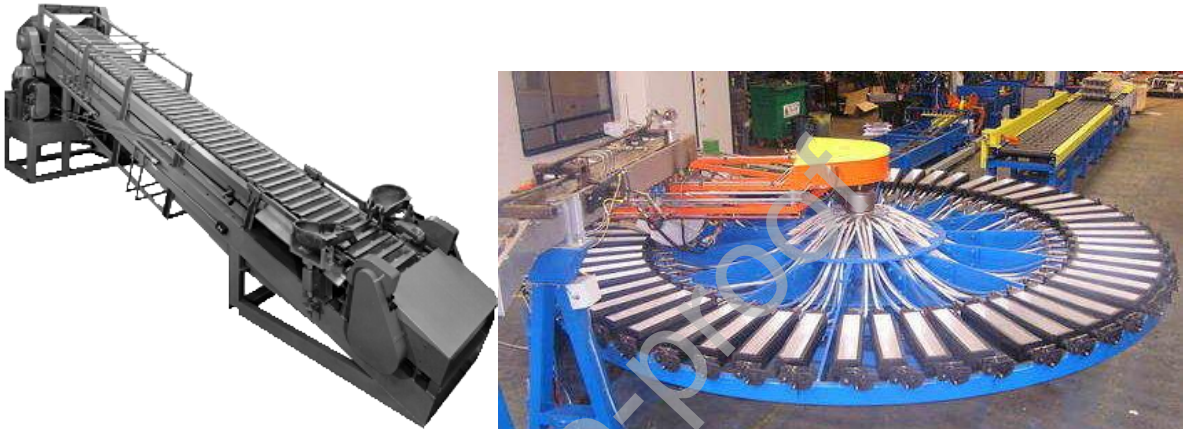

Figure 27: Continuous and rotary casting machines with cast steel ingot moulds, provided by [167,168].

4.3.3.2. Ingot Stacking Machines

Some companies fully cool the ingots prior to stacking them in a bundle, some manually ‘hot stack’ ingots as they are formed. Other companies have aimed to reduce manpower by automating the stacking process using a robotic stacker (Figure 28). Once the ingot is formed in a mould, it is cooled and released. The machine is able to reject quality-failed ingots by size, rotate the ingot to aid stacking geometry and stack them in the desired bundle configuration.



Figure 28: An example of a robotic ingot stacking machine, taken from [169].

4.3.3.3. Vertical Direct Chill Casting

The main method of producing billets is by using vertical direct chill casting (Figure 29). This technology has been around since the 1930s and is described within [170]. A starter block is inserted into a copper or aluminium mould to create a seal. Molten metal is introduced into the mould and the starter block is lowered to extrude the desired shape. Water is circulated around the mould in a manifold to cool and solidify the metal (primary cooling). Water jets spray the billet as it emerges from the mould (secondary cooling) and the water runs down the length of the billet, removing the largest proportion of heat. The billet continues to lengthen in a large pit until the desired length is achieved. The steam and hot water can be sent to cooling towers, which then releases the heat to atmosphere, an opportunity for WHR. The heat flow for direct chill casting mould walls has been best summarised by [171].

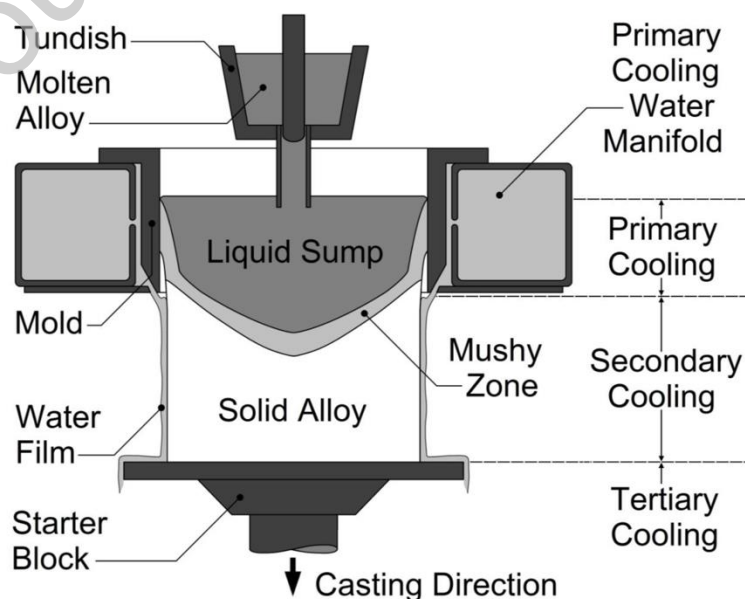

Figure 29: Schematic of vertical direct chill casting, reproduced from [172].

4.3.4. Ancillary Casting House Equipment

A large variety of additional equipment is used by smelters to achieve desired end products or to increase efficiency. Those that could play a role in WHR are described below along with some ancillary equipment.

4.3.4.1. Dross/ Slag Presses

To quench the reactions occurring in dross after removal from the furnace, dross presses were developed, an example shown in Figure 30. The dross is loaded into cast steel pans from the furnaces in the foundry and then introduced into the machine. A steel press head compacts and cools the material in the pan, stopping the reaction and agglomerating the metallic aluminium, which is then easier to recover. A thermodynamic analysis has been conducted for heat recovery on primary white dross [173] and WHR from steel slags [174].

It would be interesting to look at recovering the waste heat from black dross and salt slag. It is possible to estimate the available energy for heat recovery per kilogram of hot material using Equation 11 adapted from [95]:

$$H_a = C_{pl}\Delta T + H_m + C_{ps}\Delta T \quad (11)$$

where:

H_a = Available heat energy in hot product per kilogram, J.kg^{-1} .

C_{pl} = Specific heat at constant pressure (liquid), $\text{J.kg}^{-1}.\text{K}^{-1}$.

ΔT = Change in temperature, K.

H_m = Enthalpy of melting or fusion, J.kg^{-1} .

C_{ps} = Specific heat at constant pressure (solid), $\text{J.kg}^{-1}.\text{K}^{-1}$.

It is reported that using hot products to preheat combustion air can recover 70-80% of the sensible heat, reducing fuel consumption. In 1 kg of product, if 1 kJ of energy is recovered, fuel savings of 1.5-2.0 kJ.kg^{-1} of product is seen from reduction in heat losses from exhaust gas [95].



Figure 30: A dross press, provided by [175]. The diagram on the right shows the option to recover aluminium by draining.

4.3.4.2. Salt Slag Treatment Plants

There are companies that take and treat salt slag from secondary smelters, the available processes are summarised by [37]. Some secondary smelters internally recycle salt slag [53], first by removing more available aluminium, and separating the salt from the oxide by washing and recrystallisation. The aluminium is re-melted, the salt reused, and remaining oxide sold as a product for further processes. The first in-house salt slag processing plant (Figure 31) was developed by Altek [176] and is now being commercialised and sold around the world.



Figure 31: The first developed in-house salt slag treatment plant [176].

4.3.4.3. Metal Pumps

Metal pumps (Figure 32) circulate molten metal within a furnace or between furnaces areas. This aids in temperature and elemental homogenisation and decreased cycle times. They can also be used to transfer molten aluminium to other furnaces or crucibles. They are particularly useful in melting contaminated scrap and the clean molten metal is pumped into the larger holding chamber.

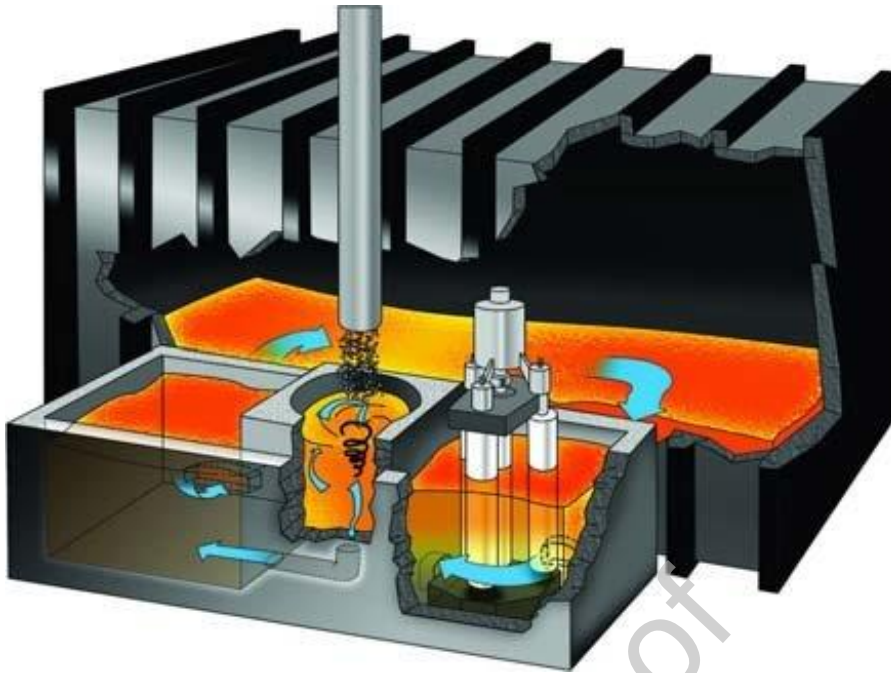

Figure 32: A furnace circulating metal with a metal pump, reproduced from [177].

4.3.4.4. Stirrers

Electromagnetic [178] and permanent magnetic [179,180] stirrers have been developed to aid homogenisation, remove residual gas and increase melt speed within holding furnaces. Electromagnetic stirrers have been reported to increase productivity by 25%, decrease energy consumption by 15% and reduce melt loss by 30% [181]. They can be mounted underneath furnaces or even to the side, allowing a stirrer to be retrofitted to an existing furnace.

4.3.4.5. Scrap Loading

Scrap can be loaded into a furnace by various methods, hand charging, using vehicles or dedicated charging equipment. The charge is placed within a container, which then uses a hydraulic ram or linearly vibrates the material (Figure 33) into the furnace. This can decrease loading time significantly and removes the need for manual charging.



Figure 33: A vibratory charging machine, reproduced from [182].

4.3.4.6. Fluxes

Some companies introduce fluxes, typically salts, to remove inclusions and oxides. They form a layer on top of the melt so also prevent the metal from burning from direct contact with burner air. They work by breaking down the aluminium oxide net that entraps metallic aluminium [183]. The most common is a eutectic mixture of sodium and potassium chloride (NaCl and KCl). Figure 34 shows how a eutectic mixture works; the melting point of the two compounds reduces to a minimum of 657°C rather than 776/ 801°C on their own. The melting point of pure aluminium is 660°C, a correct eutectic mix brings the melting point below this. Some companies add a small quantity of cryolite or calcium fluoride, CaF₂ [184].

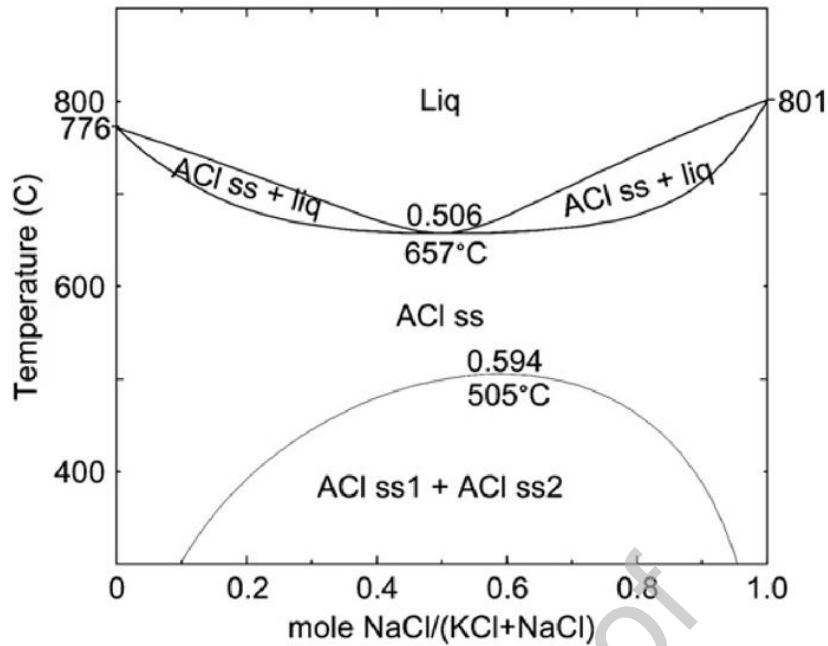
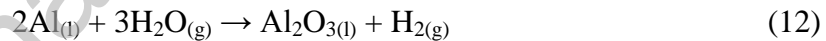

Figure 34: A binary phase diagram of KCl and NaCl, reproduced from [185]. 'ss' and 'Liq' meaning solid solution and liquid, respectively.

4.3.4.7. Degassing

When melting and holding aluminium, hydrogen is produced in the furnace from the aluminium reacting with water within false air and combustion gases. This accelerates if the melt is overheated and the hydrogen becomes more soluble as temperature increases [186]. Equations 12 and 13 show the production of hydrogen within a furnace by oxidation of aluminium and the solubility of gaseous hydrogen in Al, adapted from [150,187].



There are two main methods of degassing [188]. Firstly, argon or nitrogen gas can be bubbled through the melt removing entrapped gas but also helping with homogenous elemental distribution in static furnaces. This can be achieved using lances, rotary degassers or porous plugs [189,190] under the melt (Figure 35). Secondly, fluxes can be added to remove gas, usually chlorine or fluorine salts. The salt is charged into the molten bath and reacts with aluminium to form aluminium chloride or fluoride. These are gaseous and pass through the bath. The hydrogen diffuses into this and is removed from the furnace through the exhaust. The argon and nitrogen can be brought in bulk and stored in a tank on site. On-site nitrogen generators have been developed as well to reduce costs and means bulk storage is not required [191,192].

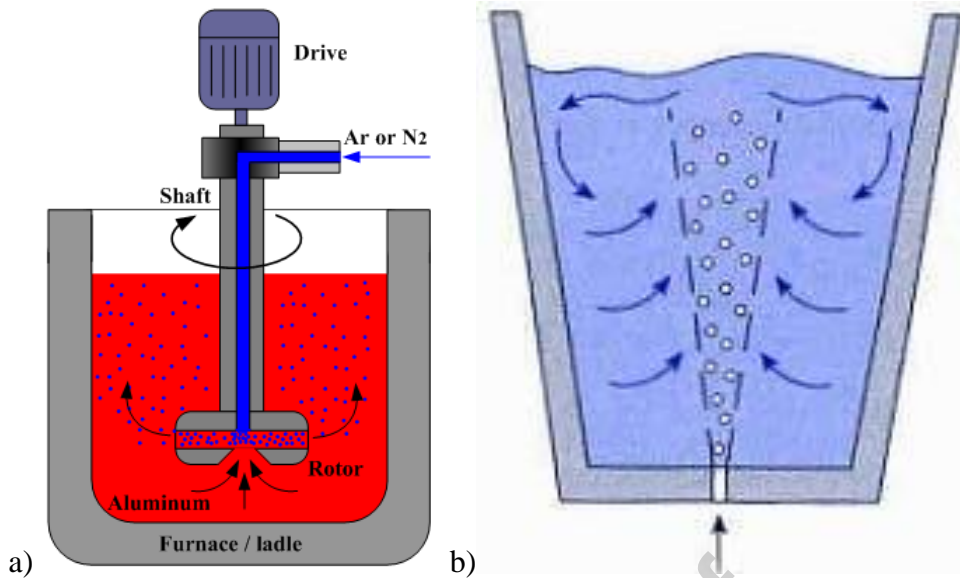

Figure 35: (a) A rotary degasser (b) A porous plug, provided by [188,189], respectively.

5. Heat Recovery Technologies with Industrial Applications

Limited literature is available on applied technologies within the aluminium industry. However, installations purely within the industry are not the only consideration, it is the form and quality of the waste heat and where developed technology can be applied. The following section highlights available studies conducted within the aluminium industry but, most importantly, what WHR technology is available and what applications there are for an end use of the waste heat. As exhaust gases are the largest contributor to losses, most technology has been developed to recover from this source. The choice of technology depends on many factors, one being temperature. For the purpose of this paper, low, medium and high temperature ranges are described by $<100^{\circ}\text{C}$, $100\text{-}400^{\circ}\text{C}$ and $>400^{\circ}\text{C}$ [193]. The section below deals with common methods of recovering available waste heat using heat exchangers or of generating electricity and steam. Temperature is only a parameter therefore it important and more valuable to determine the energy content of a waste heat stream. To illustrate this, even though a fluid may be high temperature, if there is low volume, density and flowrate, there may be little total energy content available. A low temperature stream with high volume, density and flowrate could have much larger available energy content to recover. Principles regarding to and types of heat transfer have been thoroughly studied and are found within [194].

Table 8 provides a breakdown of technology described in Section 4 with existing and potential WHR technology described throughout Section 5 with additional technologies to fully describe the state of the art. It can be seen that literature on existing applications specifically within the aluminium industry is limited but there is good potential for applicable technology.

Table 8: Sources of waste heat and applications of WHR technology

Sector	Equipment	Heat Loss Source	Temperature Range	Existing Applied WHR Technology	Potential Applicable WHR Technology
Primary	Reduction cell pots	Exhaust gases	Medium	Not Available in Literature	Thermoelectric devices, HPHEs, Rankine cycles
		Cell walls	High	Not Available in Literature	Heat pumps, Thermoelectric devices, Rankine cycles
	Anode baking furnaces	Exhaust gases	Medium - High	Not Available in Literature	Regenerators, Economisers, HPHEs, Recuperators, Thermoelectric devices, Waste heat boilers, Burner technology
		Furnace walls	Medium - High	Not Available in Literature	Thermoelectric devices
Compressor rooms	Cooling medium	Low	Not Available in Literature	Recuperator, Heat Pumps	
Refining	Flash tanks	Steam	Medium	Thermo-compressors, Shell and tube exchangers	Other Heat Exchangers
	Rotary kiln calciners	Exhaust gases, Walls	Medium - High	Review use in favour of CFB technology	
Primary and secondary casthouses	Melting and holding furnaces	Exhaust gases	High	Regenerators, Economisers, HPHEs, Recuperators, Waste heat boilers, Burner Technology, Material preheating, Decoating	Thermoelectric devices
		Furnace walls	High	Not Available in Literature	Thermoelectric devices
		Slag or dross	High	Not Available in Literature	Radiative heat pipes
	Vertical direct chill casting or conveyors	Aluminium product to atmosphere	High	Not Available in Literature	Radiative heat pipes
		Cooling water	Low	Not Available in Literature	Recuperators, Heat Pumps

5.1. Heat Exchangers

Heat exchangers are pieces of equipment that are designed to exchange thermal energy between solid surfaces or particles and fluids or two or more fluids [195]. A variety of heat exchangers have been developed for the purpose of recovering waste heat. They are found in many processes: power, transportation, air-conditioning, refrigeration, cryogenics, heat recovery, alternative fuels, manufacturing [195]. Designs and type of technology installed are based upon many factors. Considerations include the quality of the waste heat, the temperature range, flow rate, pressure, space restriction, the presence of particles or corrosive compounds and whether the two heat streams can mix or need to be kept separate. Some heat exchangers rely on natural phenomena such as the phase change of a fluid, others do not rely on phase change and are referred to as ‘sensible’ heat exchangers. The most thorough classifications and design considerations of available heat exchangers is found in [195]. A selection of commonly available technologies is described below.

It is important to know the energy content recovered by a heat exchanger. Waste heat quantity recovered can be calculated using Equation 14, adapted from [22].

$$\dot{Q} = \dot{V} \times \rho \times C_p \times \Delta T \quad (14)$$

where:

\dot{Q} = Heat energy recovered per second, W.

\dot{V} = Flowrate, $\text{m}^3 \cdot \text{s}^{-1}$.

ρ = Density, $\text{kg} \cdot \text{m}^{-3}$.

C_p = Specific heat capacity, $\text{J} \cdot \text{kg}^{-1} \cdot \text{K}^{-1}$.

ΔT = Change in Temperature, K.

The aluminium industry has specific challenges when using heat recovery equipment to recover waste heat from exhaust gases, particularly when recovering waste heat from lower temperature ranges. There are acidic gases, water vapour and particulate present, which can lead to corrosion, if the gases condense, or fouling that reduces heat exchanger effectiveness (Figure 36). Specialist materials, frequent maintenance or replacement components to counteract this corrosivity can be an expensive practice. If the heat exchangers are designed to not drop below dew points, there will permanently be a proportion of energy that is unrecovered. In heat exchangers, if there is a small temperature gradient between two fluid streams, the heat transfer rate is less compared if there is a higher temperature gradient. Therefore, low temperature heat exchangers can require a larger heat transfer area to compensate for the reduced heat transfer rate. For these reasons, if the heat exchanger is large and requires advanced materials, it can be uneconomical to recover the waste heat. [99]



Figure 36: Corroded and fouled recuperators from an Aluminium melting furnace, taken from [99].

5.1.1. Air Preheaters

Air preheaters are used to transfer heat from exhausts into another air stream. They are most useful when cross contamination of fluids must be avoided and typically work in low to medium temperature applications. Typical examples are rotary regenerators, recuperators and run around coils, described below. [22]

5.1.1.1. Rotary Regenerators

With a rotary regenerator, a hot stream passes through a porous material with a high thermal capacity such as a honeycomb or ceramic disk, which heats up. As the porous wheel rotates, a cooler stream passes through the material and heat is transferred to the stream from the wheel and the cycle repeats. Typical uses are for low to medium temperature ranges but high temperatures are possible and they can provide a high efficiency of heat transfer [196]. Overall efficiency has been reported as high as 85%, however reliability of the seals and fouling have caused issues particularly with plugging of the wheel passages if the gas has particulate loading leading to significant pressure drop [197]. These wheels have been built having diameters as large as 21 m and throughput of $1130 \text{ m}^3 \cdot \text{min}^{-1}$ of air [198].

Figure 37 Figure 38 show a schematic and installation of rotary regenerators developed by Jasper GmbH to reclaim heat from furnace exhaust gases. Crucially, high temperatures up to 1600°C are targetable reducing to an output of $140\text{-}310^\circ\text{C}$. Up to 62% fuel reduction has been calculated with the aim to preheat combustion air for burners up to 1400°C . [199,200]

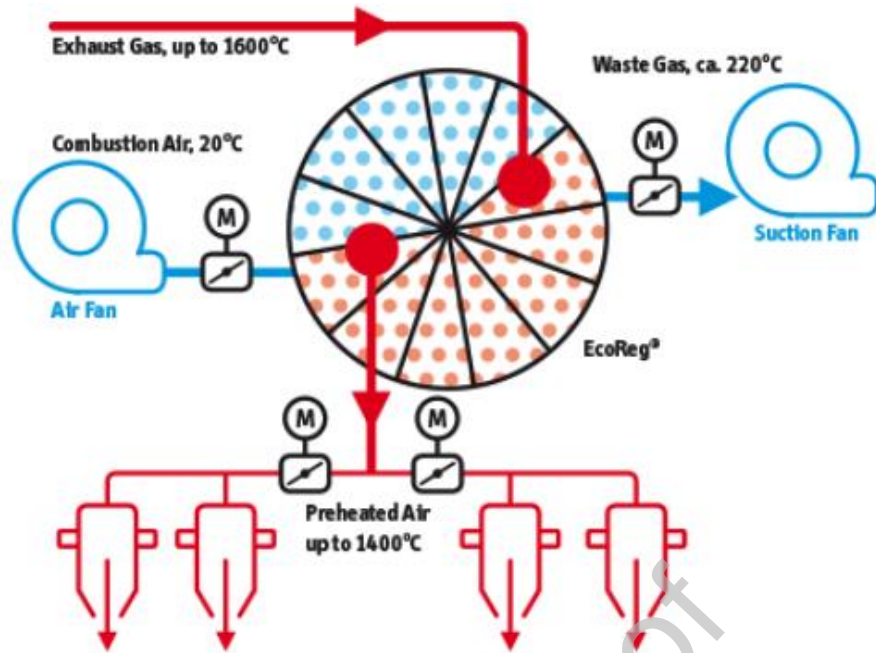

Figure 37: EcoReg rotary regenerator schematic, provided by [199].

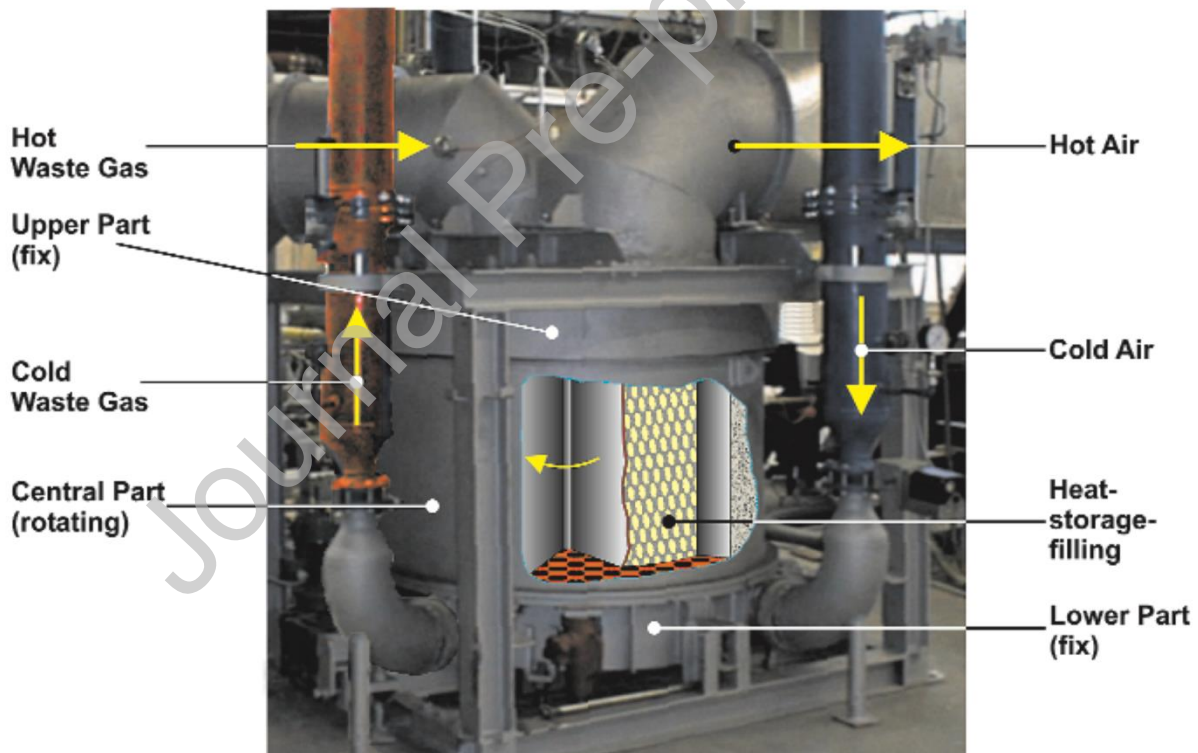

Figure 38: EcoReg regenerator, taken from [200].

5.1.1.2. Run Around Coils

A run around coil is another example of an air preheater. This contains a heat transfer fluid that is pumped between two coiled heat exchangers [201]. A warm stream passes through one heat exchanger, warming the heat transfer fluid, this is transferred to a heat exchanger where the heat is extracted by a cool stream and the cycle repeats (Figure 39).

The choice of this design compared to a rotary regenerator is down to access to the streams. The streams pass close to each other in a rotary regenerator whereas if the streams are separated at distance a run around coil pumps the heat between locations. The downside is that energy is required to pump the heat transfer fluid and low effectiveness has been reported [202].

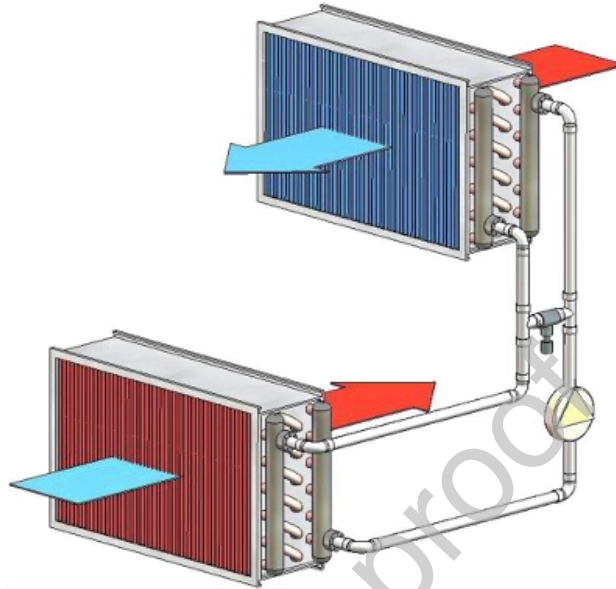

Figure 39: Diagram of a run around coil, taken from [203].

5.1.2. Compact Heat Exchangers

Compact heat exchangers have been developed to reduce the size of a heat exchanger installation. They are designed to have a high area density i.e. a high area of heat transfer surface to heat exchanger volume. A heat exchanger is normally defined as compact when values are $700 \text{ m}^2 \cdot \text{m}^{-3}$ for gas to gas exchangers and $400 \text{ m}^2 \cdot \text{m}^{-3}$ for gas to liquid or liquid to gas. Li et al. [204] provides a detailed review regarding the design and performance of compact heat exchangers. Examples of compact heat exchanger designs include plate and frame, brazed plate, plate-fin, welded plate, printed circuit, spiral and ceramic.

Literature on installations of compact heat exchangers for the aluminium industry are not available but efforts are being made to reduce the size of installations. Bouhabila et al. [205] developed and tested a heat exchanger at Norsk Hydro primary aluminium smelter in Norway. Though not technically compact, a heat exchanger with 129 m^2 of heat transfer surface area was designed and installed to cool 140°C exhaust gases ($68,300 \text{ m} \cdot \text{hr}^{-1}$) from the reduction pots prior to entering the Gas Treatment Centre (GTC). The installed unit had oval shaped tubes and fins and was able to reduce fouling by approximately 10-15%.

5.1.3. Economisers

Economisers are usually a gas to liquid or gas to gas heat exchanger installed within the ductwork of hot exhaust gas streams. The economiser is normally used for low-medium temperature applications. An example of a gas to gas economiser used to recover heat from flue gas is shown by Figure 40. There are tubes, sometimes finned or coiled to increase

surface area, with a liquid or gas passed through the tube. The heat transfers from the exhaust gas to the heat recovery fluid through the tube walls. The warmed heat transfer fluid is generally used to optimise a further process by reducing primary energy required [22]. Examples include raising the temperature of feedwater in a boiler or steam generator. By recovering flue gas temperatures, boiler systems have been shown to increase efficiency by 1% for every 5°C reduction [206].

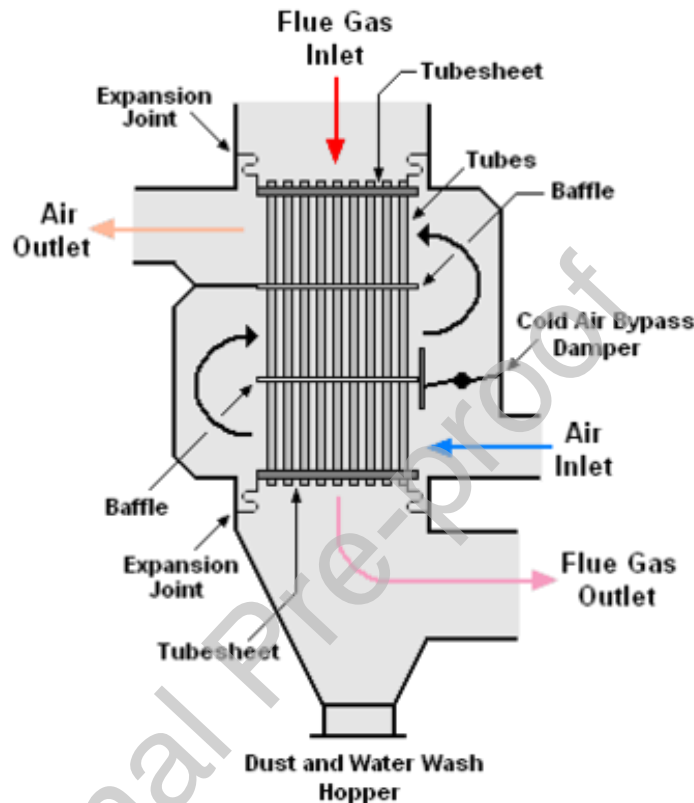

Figure 40: A diagram of a multi-pass economiser, reproduced from [203].

5.1.4. Heat Pipe Heat Exchangers

A heat pipe is a hermetically sealed pipe or series of pipes, containing a heat transfer working fluid used to transfer heat. The pressure in the heat pipe depends on the saturation temperature of the internal working fluid. The material for the pipe has commonly been copper for applications of low temperature ($<100^{\circ}\text{C}$), but other materials are being developed with examples provided by [207], which include variants of stainless steel, carbon steel, aluminium and titanium. The working fluids are variable, depending on the application temperature, the most common being water due to its physical properties, environmental friendliness, non-flammability, cost and availability. Figure 41 shows a range of working fluids and their temperature ranges and due to the range of working fluids and pipe materials, low medium and high range temperatures can be covered [208]. The key beneficial feature of a heat pipe heat exchanger is that it does not have any moving parts, being a totally passive technology. Each pipe works independently as an individual heat exchanger, so redundancy is built in if one pipe fails. If a pipe fails, there is little contamination into the heat streams

and one pipe failure will not affect significantly the operation of the entire system [209]. They are among the most efficient methods of heat transfer [210]. Heat pipes have a higher effective thermal conductivity and conductance potential than other traditional heat exchangers with heat transfer coefficients of 10^3 - 10^5 $\text{W}\cdot\text{m}^{-2}\cdot\text{K}^{-1}$ reported [211].

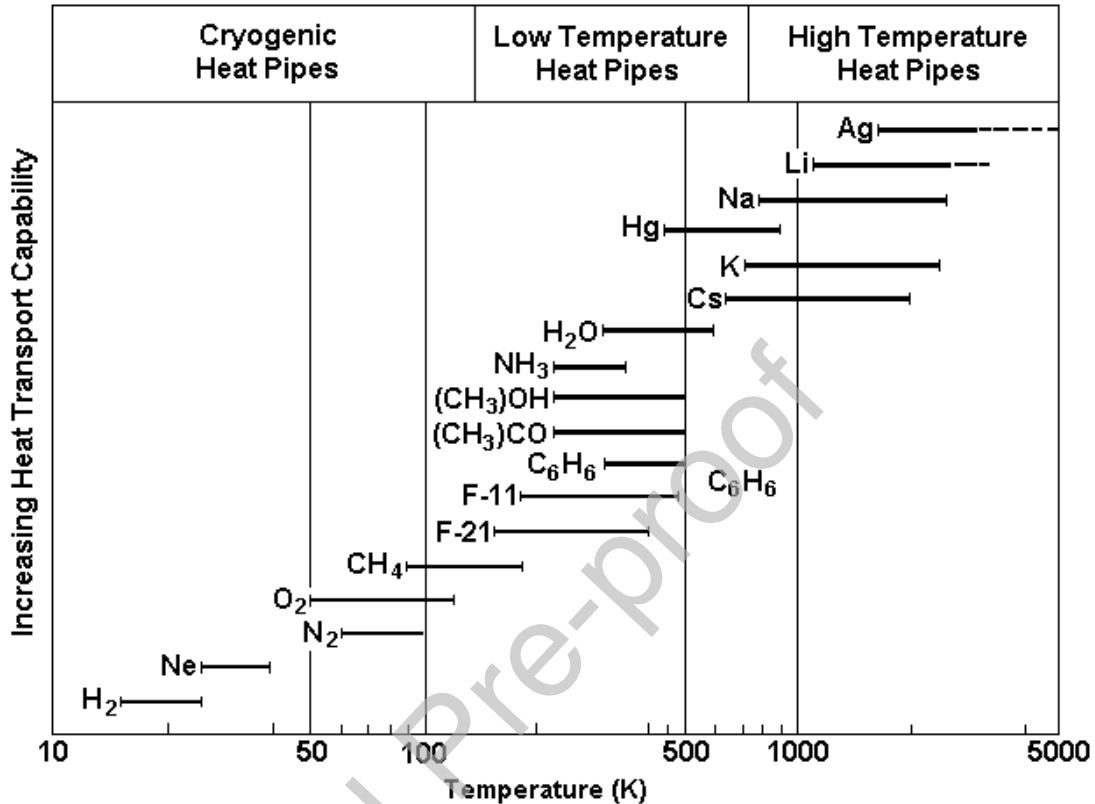

Figure 41: Range of working fluids for heat pipes, reproduced from [212].

The function of a heat pipe is shown in Figure 42. Heat introduced at the evaporator section passes to the working fluid. As the working fluid is in the saturation phase, it evaporates readily and moves towards the condenser. Energy is released through the walls of the condensing section, the working fluid condenses and the cycle can be repeated as the working fluid travels back to the evaporator section. Figure 43 shows how wicks have been incorporated onto the internal wall of the heat pipe to aid cycling of the working fluid against gravity. The condenser and evaporator sections can be externally split by using a plate. This has the effect of separating the incoming and outgoing streams of heat.

Figure 44 shows an external view of a 500 kW heat pipe heat exchanger designed to preheat combustion air for an aluminium furnace. It was a smooth heat pipe heat exchanger designed to minimise fouling from high particulate content. The exhaust was cooled from 400 to 266°C and air temperature was raised from 30 to 293°C, recovering 528 kW of energy. [213]

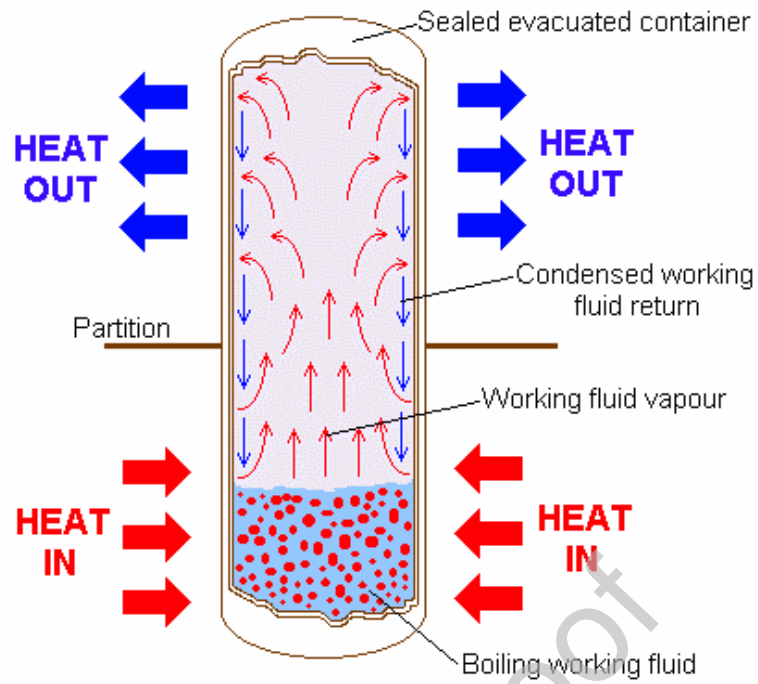

Figure 42: Diagram of a functioning heat pipe, reproduced from [212].

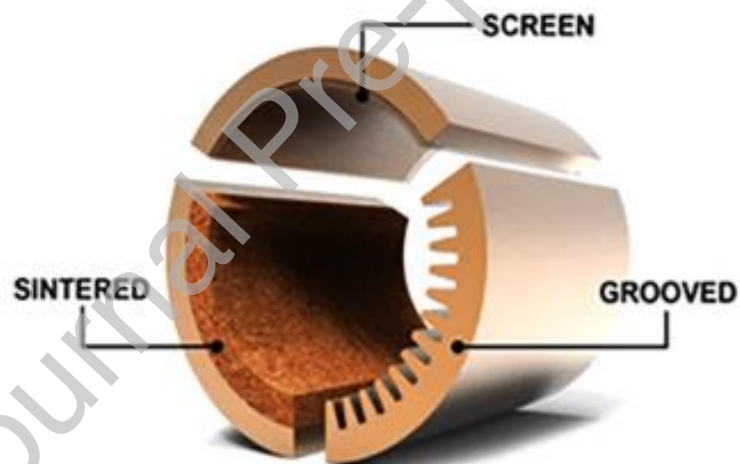

Figure 43: A selection of wick designs, reproduced from [214].



Figure 44: Heat pipe heat exchanger used to preheat combustion air. Taken from [213].

Further types of heat pipe designs include thermosyphons, capillary driven, annular, rotating, gas loaded, loop, capillary pumped loop, mono-groove, micro and miniature, inverted meniscus [211], radiative [215] and pulsating heat pipes [208]. There is substantial amount of literature available on heat pipes. [209] and [208] provide thorough reviews on heat pipes with applications found in regard to WHR provided by [216]. Further work is required to determine whether heat pipe heat exchangers can be applied to waste heat sources from the aluminium industry.

5.1.5. Heat Pumps

Thermal energy moves from high to low temperature. The basis of a heat pump is to reverse this process by applying the second law of thermodynamics. An impeller draws a warm substance over a system of coils with an internal refrigerant. The refrigerant absorbs the heat through the walls of the coil, expanding and eventually evaporating. The choice of refrigerant is important depending on the heat source and new refrigerants are being developed that will not affect the environment if accidentally released. A compressor is used to compress the evaporated refrigerant, this increases its temperature. The hot refrigerant is directed to where the heat is desired, and the heat is released by condensing the refrigerant. The liquid refrigerant returns to the compressor after it passes through an expanding valve which reduces its pressure and decreases its saturation temperature. Examples include air source, water source and ground source heat pumps in domestic applications. Heat pumps are not just found in residential applications, but also in industrial and commercial situations. They are unique in the fact that they are predominantly designed to extract heat from the environment but they have also been applied to recover waste heat. The majority use mechanical vapour compression in open or closed cycles but thermal types are also used. [217,218]

Figure 45 shows examples of heat pump schematics and Figure 46 shows the thermodynamic cycle used as the operating principle behind heat pumps. The fact that as pressure increases, boiling point of fluid increases, is exploited [218].

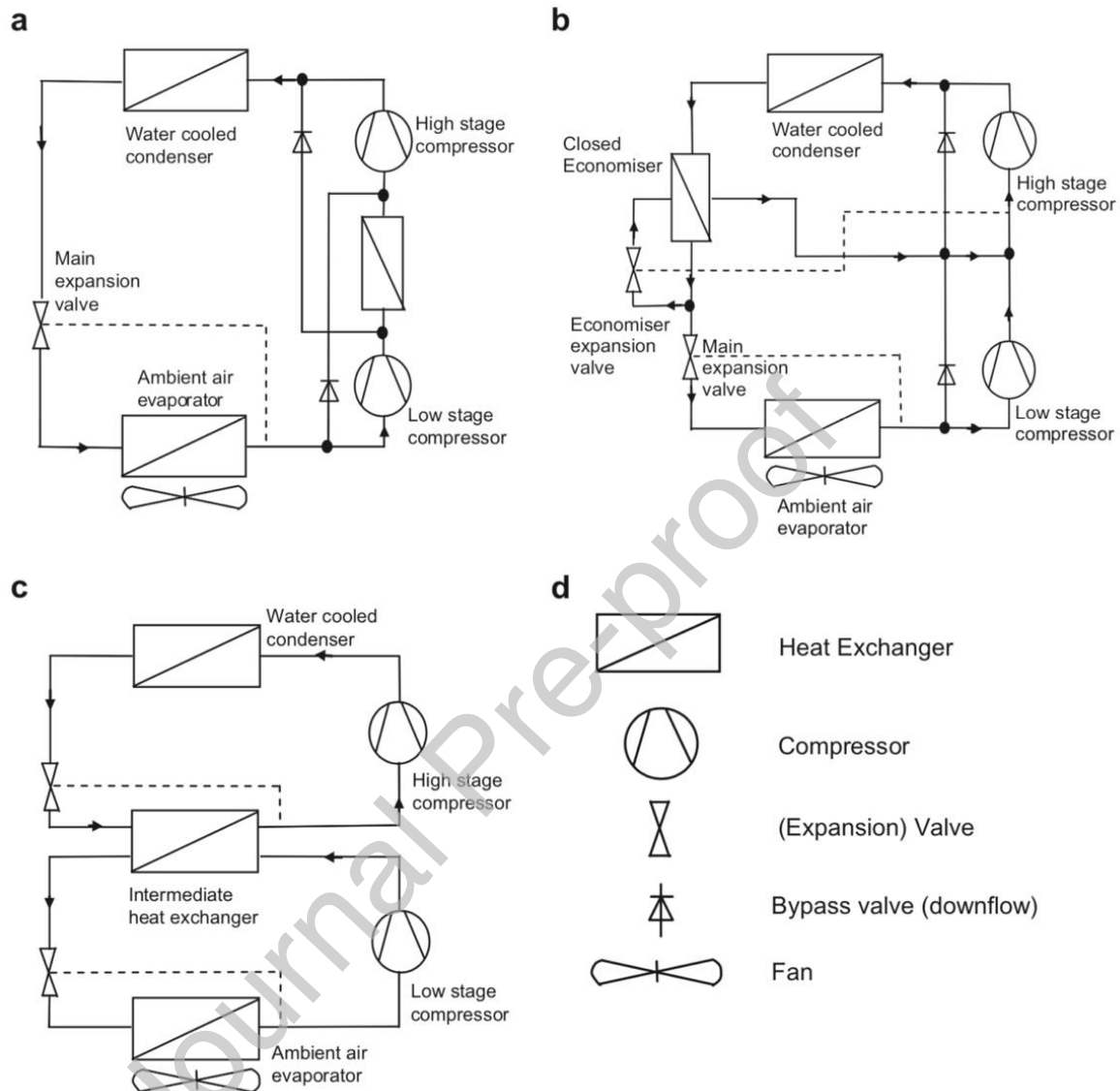

Figure 45: Schematics of three heat pump systems, reproduced from [217]. (a) two-stage cycle with intercooler, (b) two-stage cycle with closed economiser, (c) cascade cycle, (d) legend.

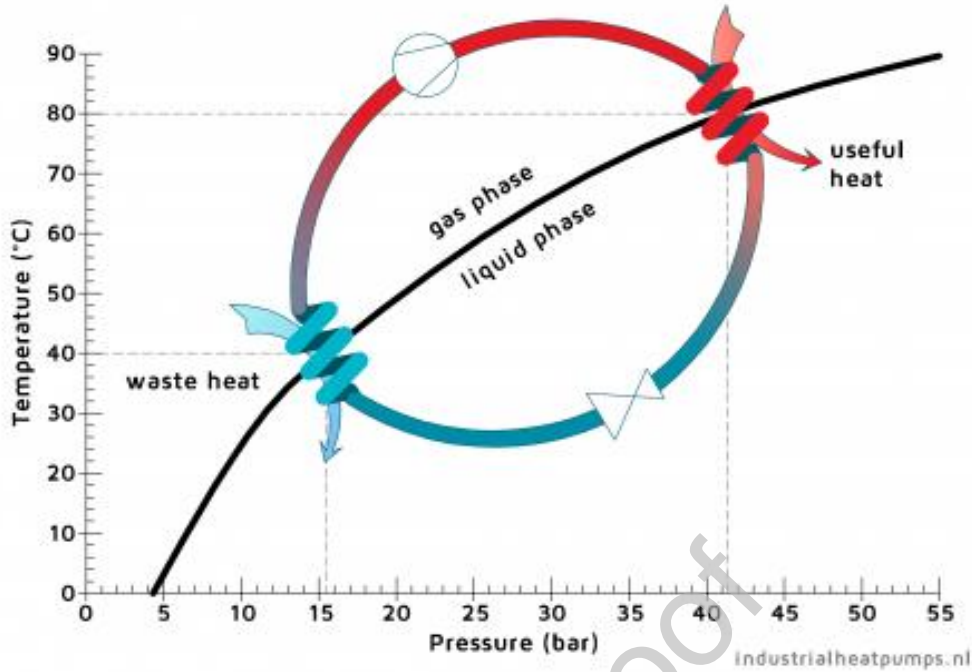

Figure 46: Graph showing the thermodynamic cycle principle used for heat pumps, reproduced from [218].

Nowicki and Gosselin [98] studied the application of heat pumps to the primary smelter Alcoa Deschambault Quebec to recover waste heat for space heating purposes. There was 4.9 MW of heat available from casthouse cooling water and 2.5 MW from the water/glycol mixture in the compressor rooms, both at 40°C. If a heat pumps with coefficient of performance of 4 were used, 6 kt of CO_{2eq} emissions could be saved by reducing primary energy needed for space heating purposes, equating to a saving of around \$300,000 per annum.

5.1.6. Recuperators

Recuperators transfer heat from gas to a fluid through a ceramic or metallic tube wall. The arrangement is variable, it can be parallel, cross or counter flow depending on the installation requirements. There are four main types of recuperator, these are: radiation recuperator, convective recuperator, hybrid recuperator and ceramic recuperator [198]. For recuperators with planar walls, the heat transferred is shown by Equations 15 and 16 [95]:

$$\dot{Q} = UA\Delta T_{lm} \quad (15)$$

$$U = \frac{1}{\frac{1}{h_{inside}} + \frac{x}{\kappa} + \frac{1}{h_{outside}}} \quad (16)$$

where:

\dot{Q} = Heat energy transferred per second, W.

U = Overall convective heat transfer coefficient, W.m⁻².K⁻¹.

A = Heat transfer area, m².

ΔT_{lm} = Logarithmic mean temperature difference, K.

h = Convective heat transfer coefficient, $\text{W}\cdot\text{m}^{-2}\cdot\text{K}^{-1}$.

x = Width, m.

κ = Thermal conductivity, $\text{W}\cdot\text{m}^{-1}\cdot\text{K}^{-1}$.

5.1.6.1. Radiative Recuperators

A radiative recuperator is the simplest form of recuperator and it is shown in Figure 47. It is made from two concentric metal tubes with exhaust gases passing through the inner tube and the heat transfer gas passing around the inner tube, extracting heat predominantly by radiation. This type of recuperator was traditionally used to recover exhaust gas heat in the primary industry, operating at over 850°C as they achieve some of the lowest pressure losses [219]. There is economic justification for their use with the 40-60% efficiencies seen but they require high maintenance and cleaning due to fouling by condensable vapours and particulates [197]. However, other technologies are more effective at transferring heat and dilution was required to cool the exhaust gas if metallic radiation recuperators were used.

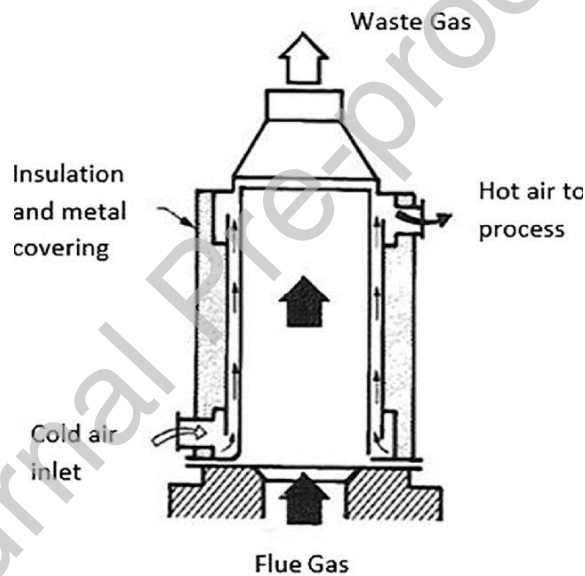

Figure 47: A radiative recuperator. Reproduced from [220].

5.1.6.2. Convective Recuperators

A convective recuperator consists of a bundle of multiple tubes, typically of diameters between 25 – 75 mm, through which hot gas passes. This is surrounded by a shell enclosing the tubes. A cool fluid passes through this shell in order to extract heat. The inside of the shell can be baffled in order to allow multiple passes past the inner tubes in order to increase heat transfer effectiveness, predominantly by convection. These exchangers can work at over 1000°C but are recommended for low temperature, high mass gas flow. The main difficulty with this heat exchanger is fouling. [221]

5.1.6.3. Hybrid Recuperators

A hybrid recuperator, shown in Figure 48, combines the principles of both the radiation and convective recuperator. It has two areas; radiative and convective sections. The first section

cools a fluid using the radiative technology, the hot gas is directed through tubes and the cooling fluid is passed through a shell as with a convective recuperator.

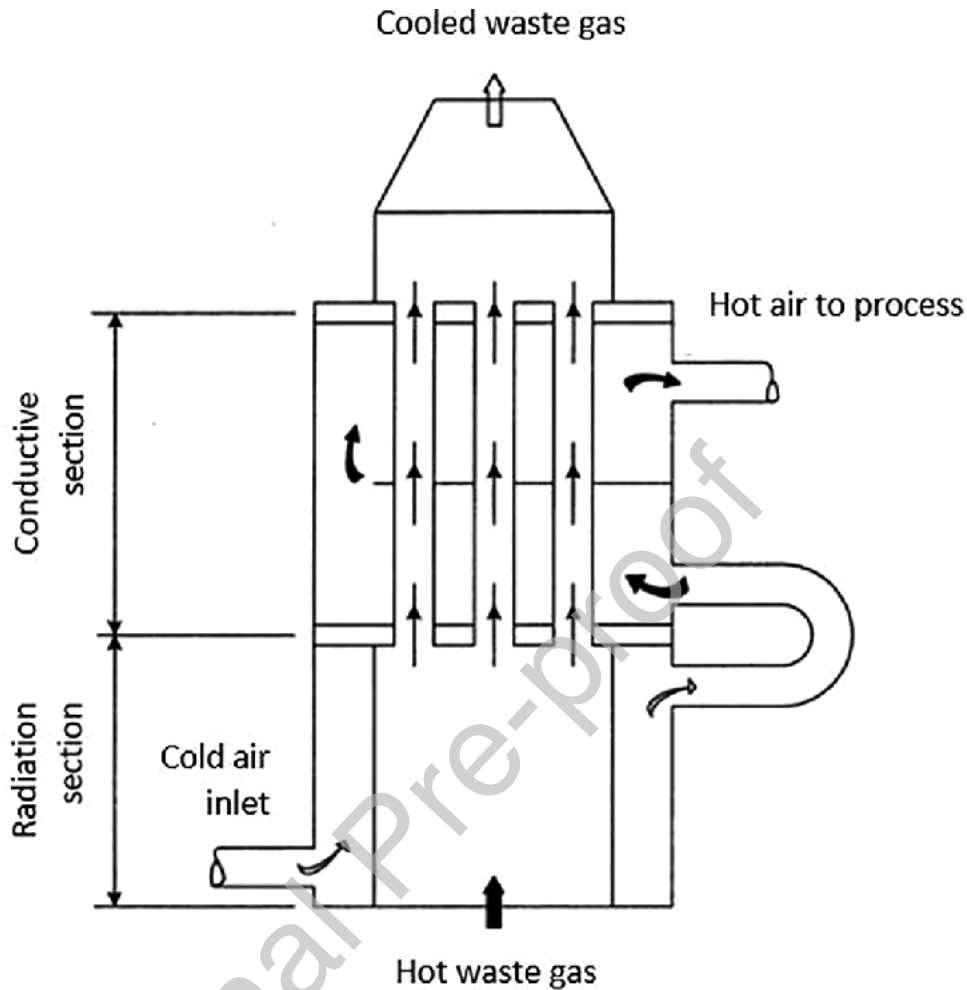

Figure 48: A hybrid recuperator with both a convective section. Reproduced from [222].

5.1.6.4. Ceramic Recuperators

If temperatures exceed 1100°C , metallic recuperators experience a significant decrease in lifespan. Ceramic recuperators were developed to cope with temperatures that metallic recuperators could not. These recuperators can tolerate up to 1550°C inlet exhaust gas and 815°C outlet for the preheated air [198].

5.1.7. Shell and Tube Heat Exchangers

A shell and tube heat exchanger (Figure 49) consists of a series of tubes that a heat transfer fluid can pass through, that can either be heated or cooled. Another fluid passes over and around these tubes to absorb heat. The tubes can be smoothed or finned to increase heat transfer surface area. Baffles can be introduced around the tubes to direct the flow of fluid, creating turbulence and therefore increased heat transfer. These types of heat exchangers are normally used for high-pressure, medium temperature applications due to high pressure drop. Pressures greater than 30 bar and temperatures greater than 260°C are seen. [223]

As with radiative recuperators, this technology suffers from fouling with particulates or condensable vapours. Furthermore, cold spots with condensation moisture can suffer from corrosion. [197]

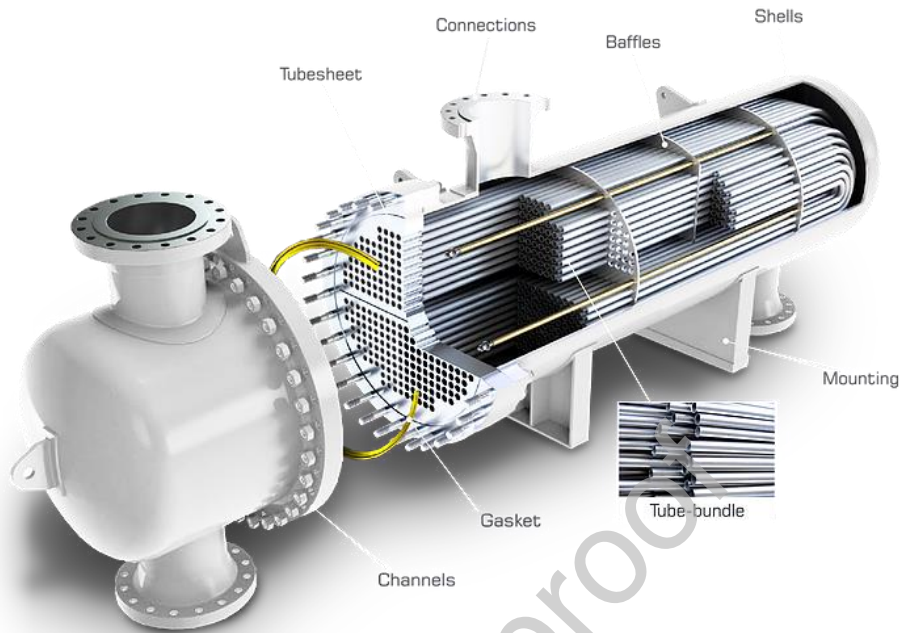

Figure 49: An example of the internal workings of a shell and tube heat exchanger, reproduced from [224].

5.2. Direct Electrical Conversion Devices

The section below deals with emerging technologies used to create electricity directly from waste heat. These include piezoelectric power generation, thermoelectric generation and thermionic generators.

Piezoelectric devices are an emerging technology designed for low temperature ranges yet to be fully tested in industrial applications. They work by converting compressional or vibrational energy into electricity [225], for example oscillatory gas expansion [22]. When the piezoelectric material deforms as a result of these applied forces, the material polarises, and opposite charges accumulate on different faces. This charge is collected and stored [225]. Material choices include piezoelectric ceramic, glass, crystals and thin-films [225]. These piezoelectric materials are currently expensive to produce, have low efficiency and unimpressive durability [22] but do not release emissions and can target low temperature ranges traditionally ignored.

Thermoelectric devices were invented in 1821 and work by the Seebeck effect. Even though they were invented nearly two centuries ago, they have recently been gaining increased research interest, particularly for WHR applications. They are semiconductors that generate current and require two surfaces of different temperatures (Figure 50). Currently, they are low efficiency (2-5%), but work is being undertaken to improve this. The thermoelectric

figure of merit values (determined by Equation 17) seen are approaching $c.1.5$, with values of 3-4 required to be competitive with other technologies like mechanical generation. [22,197]

$$zT = \frac{\sigma S^2 T}{\kappa} \quad (17)$$

where:

zT = Thermoelectric figure of merit, dimensionless.

σ = Electrical conductivity, $S.m^{-1}$.

S = Seebeck coefficient, $V.K^{-1}$.

T = Temperature, K.

κ = Thermal conductivity, $W.m^{-1}.K^{-1}$.

Yazawa and Shakouri [226] modelled water-cooled low profile thermoelectric devices in a 54cm thick refractory lining of a melting furnace to generate electricity. The furnace modelled was used to melt glass pellets. The furnace gases were at $1500^\circ C$ to maintain the molten glass at $1000^\circ C$. $10 kW.m^{-2}$ heat flux thermoelectric devices were chosen and power generation of up to $1.72 kW.m^{-2}$ was estimated for the 500t per day facility.

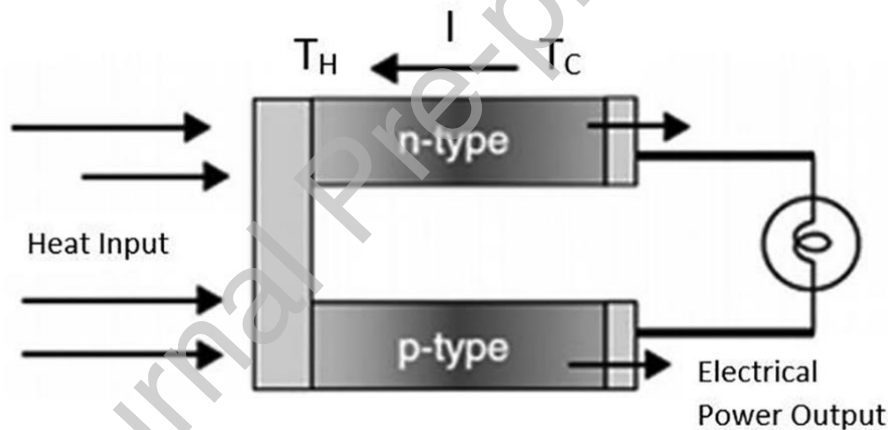

Figure 50: Thermoelectric generator showing current (I) generated by a temperature difference across semiconductor material, reproduced from [227].

Thermionic devices are the last direct electrical conversion device described of which there are two types, a vacuum or vapour thermionic energy converter. They were created in the 1950's but have since had little accomplishment in successful applications mainly due to lack of material choice. They use a phenomenon known as thermionic emission across two surfaces with a differential temperature, an emitter and a collector. Electrons can flow from the metallic or metal oxide emitter to the collector, through an interelectrode space, which is in a vacuum vapour or plasma, generating electricity. They have been found to be usefully limited to high temperature applications ($2000^\circ C$ was modelled by [228]) but are practically inefficient even with theoretically high Carnot efficiencies. [229,230]

5.3. Steam Generation and Reuse

A common method of recovering waste heat is by generating steam. The benefits of using water are that it is freely available, non-harmful and can be discharged with little environment impact. Waste heat boilers and thermo-compressors are the main technologies that deal with steam.

5.3.1. Waste Heat Boilers

Heat can be used to make steam using waste heat boilers and can be recovered by using heat recovery steam generators. Hot exhaust gas is passed over tubes containing water, which vaporises. The steam is collected and used for heating, process steam or electricity generation (Figure 51). The steam needs a medium - high temperature range to be effective. In the example below, 480-590°C exhaust gases were used with supplementary burners. The boiler was 65-70% efficient [197].

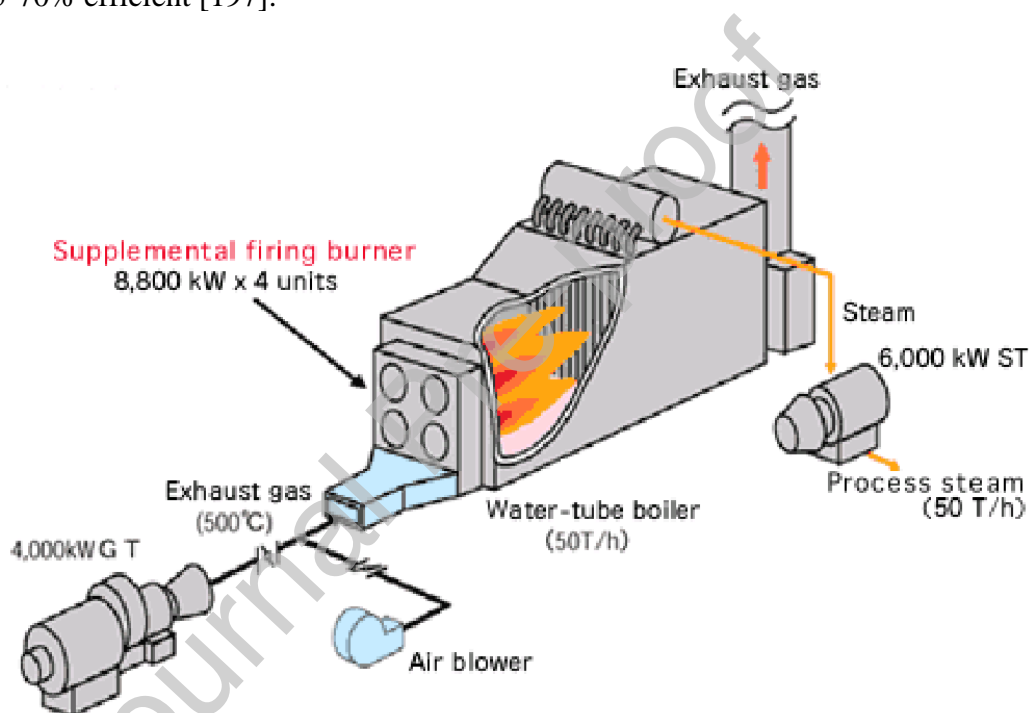

Figure 51: A waste heat boiler using gas turbine exhaust gases, reproduced from [197].

5.3.2. Thermo-compressors

Steam jet thermo-compressors (Figure 52) are a technology used to recycle steam generated from within a process. Fresh, high temperature steam is generated and is passed through a chamber at high pressure. This draws in the lower temperature process steam, which is mixed. The mixed steam of an intermediate temperature is repressurised and reused, recycling the energy content. In the refining process, evaporated steam produced is used to preheat the bauxite, sodium hydroxide solution. In this way, waste heat is reused. However, to reach the final temperature required for digestion involves injecting additional steam created from primary energy [42]. Generating additional steam from other processes could aid filling this gap.

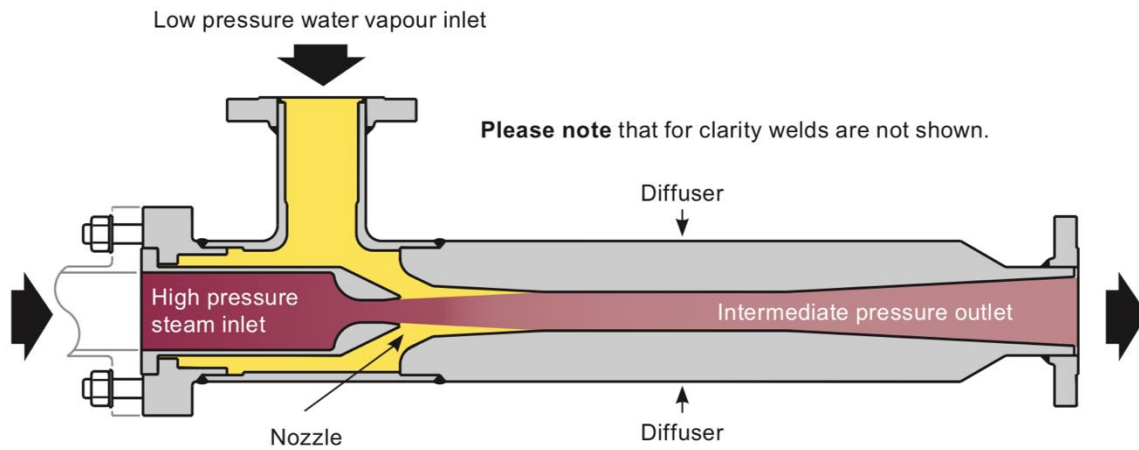

Figure 52: A steam jet thermocompressor. Provided by [231].

5.4. Burner Technology

One method of optimising process conditions is to ensure full and efficient combustion. Recuperative and regenerative burners have been developed to improve combustion efficiency by utilising waste heat.

5.4.1. Recuperative Burners

It is calculated that preheating combustion air can increase furnace efficiency up to 50%, a very attractive proposition, shown in Table 9 [99]. Recuperative burners (Figure 53) work by preheating the air used for combustion, which increases the combustion efficiency, therefore reducing fuel consumption and overall emissions. The heat is taken from the exhaust gas and burner nozzle and transferred to the combustion air through heat exchanger surfaces [22].

Table 9: Furnace efficiency improvement by preheating combustion air, adapted from [99].

Furnace Outlet temperature, °C.	Combustion Air Preheat Temperature				
	204 °C	316 °C	427°C	538 °C	649 °C
1427	22%	30%	37%	43%	48%
1316	18%	26%	33%	38%	43%
1204	16%	23%	29%	34%	39%
1093	14%	20%	26%	31%	36%
982	13%	19%	24%	29%	33%
871	11%	17%	22%	26%	30%
760	10%	16%	20%	25%	28%

For a rotary kiln in the ceramics industry, a recuperative heat exchanger to preheat combustion air was numerically modelled and experimentally validated by [232]. The recuperator reduced fuel consumption by 12%, increased energy efficiency by 7.35% and increased exergy efficiency by 3.81%. Saying this, recuperative burners have lower efficiency in heat recovery than other technologies (<30%) and cannot be used with particulate-loaded or condensable vapour-containing exhaust gases [197].

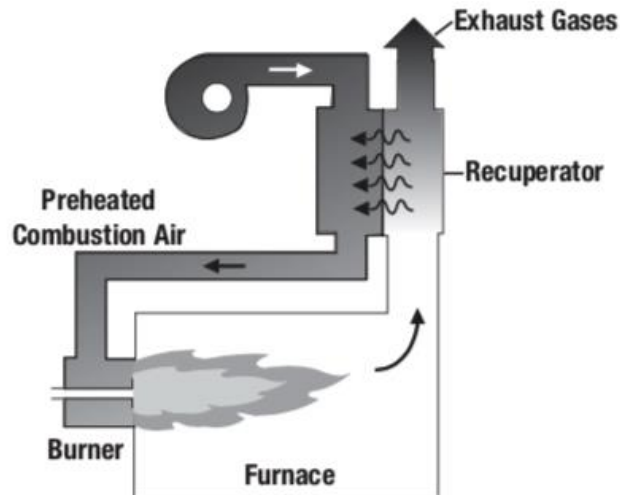

Figure 53: Schematic of a recuperator being used to preheat combustion air, taken from [149].

5.4.2. Regenerative Burners

Regenerative burners work like recuperative burners by preheating the combustion air but using alternating burners and direct heating and they are described by [22]. While one burner is firing, the exhaust gas passes through the body of the second burner combustion firing port to a heat exchanger medium, usually non-reactive ceramic alumina balls with a diameter of 2-3 cm [11], which extracts and stores heat energy from the gas. Once the medium is heated, the fuel, exhaust and air valves reverse the flow and the combustion air flows through the heated medium, preheating the air and increasing burner efficiency whereupon the cycle repeats. Though fuel consumption can be reduced by as much as 40-45% [158,233], the system can be complicated and requires additional control measures. Retrofitting these burners requires modifications to the furnace body and the installation of new pipe and ductwork. This can come at a high capital cost. Most smelters only have limited downtime and so major modifications can only be scheduled at certain times and the smelters cannot suffer downtime of production. Figure 54 shows the workings of a pair of regenerative burners. Voyer and Caron [234] built an energy efficiency model and determined that installation of regenerative burners was cost effective for melting furnaces but not for holding furnaces.

Hassan and Al Kindi [158] conducted a feasibility study of regenerative burners in aluminium holding furnaces by developing a thermodynamic model and validating the results at a working foundry. Interestingly, the authors found that regenerative burner furnaces were not profitable in saving energy and could shorten the lifespan of the furnace. The main reasons for this were that due to the increase in combustion air temperature, the resulting flame has a higher temperature, which led to thermal shocks in the refractory lining, increased dross generation and metal alloy degradation due to the superheating of the surface of the molten metal bath. The study found that the most significant factors in increasing the efficiency of operation were reducing the amount of time the furnace doors are open and by reducing the overall holding time.

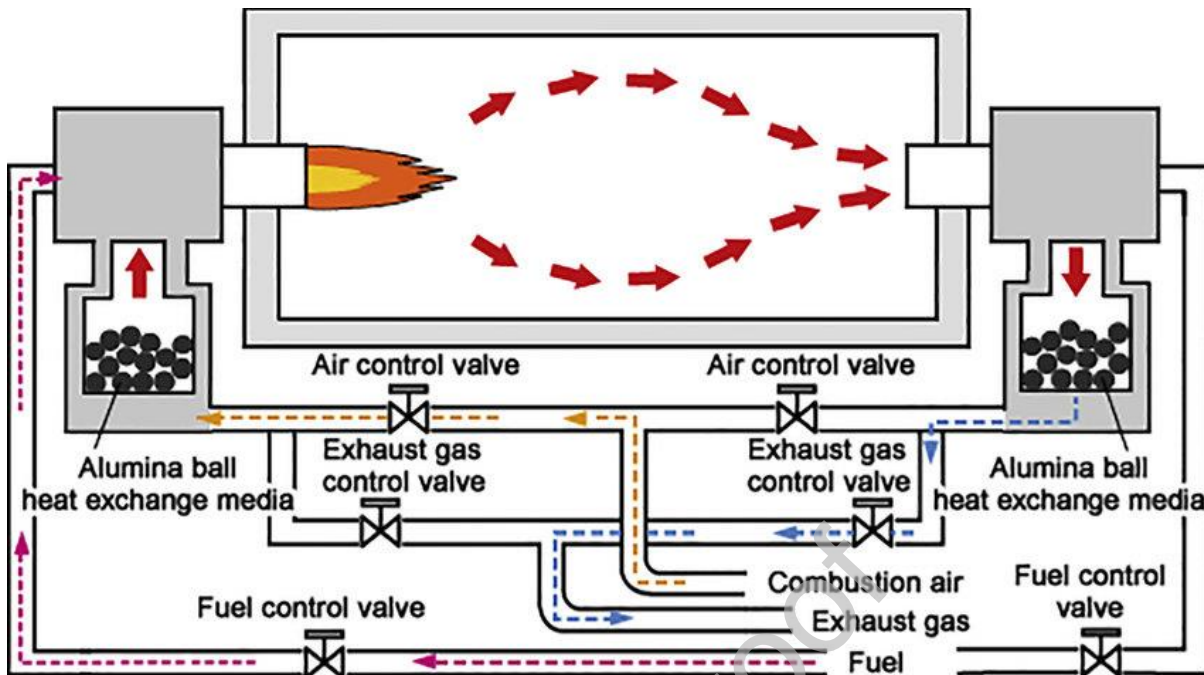

Figure 54: Diagram of a regenerative burner system with pipework and control valves, reproduced from [235].

6. Potential Applications for Technologies

Whilst prevention of waste heat should be at the forefront of design and technology, waste heat is inevitable. Heat that is reclaimed can be utilised, providing economic, environmental or safety benefits, and the following ways identified that could be applied to the aluminium industry are highlighted below.

6.1. Space and District Heating

Heat can be redirected for space heating purposes of adjacent offices or by transferring heat to cooler areas either through a liquid or gaseous medium. Large producers of heat have heated neighbouring towns and villages [236]. Space heating can reduce electricity or fuel costs by eliminating the need for boilers or alternative space heaters, reducing operating overhead costs. However, this may not be required in geographically warm climates or not all year round in mild climates, limiting the benefits.

It was proposed that a steel casting factory could heat the most densely populated areas of a town called Udine in Italy by recovering waste heat. A heat exchanger for district heating was proposed close to the facility in order to create hot water for the 1750 inhabitants. [237] modelled and confirmed feasibility.

6.2. Scrap and Material Preheating

Material that is introduced into a furnace that contains a molten bath needs to be dry to avoid superheated steam generation causing devastating explosions. The waste heat in the exhaust gas from the furnace burners can be used to dry the moisture from the material but also raise

its temperature from ambient [238,239]. Scrap preheating has also been studied using solar thermal energy [240]. If the material is raised from ambient, it requires less energy to melt when introduced to the furnaces and cycle times are decreased. A normal practice when charging furnaces is to put material on the ledge for a period of time before charging into a molten bath. This can require the furnace door to be open, which loses a large quantity of heat from convection and radiant heat. If the material is loaded dry and submerged, the furnace door can be shut more quickly, and less heat is lost. This reduces fuel consumption and emissions and improves productivity by decreasing the production cycle times. Preheating scrap to 100°C prior to charging can reduce cycle times by 8 minutes [238]. Furthermore, 21.1% energy saving and a 25.5% increase in production have been calculated if exhaust gases were used to preheat the charge [241].

Johansen and Strømhaug [242] measured energy input to a typical furnace cycle where charged metal was preheated and then molten metal was added prior to casting. They calculated the relative energy consumption used in the process. The authors found that around 75% of energy was used to preheat cold metal and 18% during casting to prevent freezing and maintain metal temperature.

The benefits of preheating scrap prior to charging are resounding but the capital costs are high and the installation requires the rerouting of major flue ducting. Companies with limited space will struggle to retrofit a large installation. Careful attention has to be paid to the scrap that is introduced as any contamination or coatings can be volatilised and release harmful emissions. Controls have to be added to avoid hotspots causing the aluminium to melt and the preheating station is an interface between an operator and hot process gases so requires careful safety consideration to its use.



Figure 55: A chamber preheating aluminium sows using waste heat, reproduced from [243].

6.3. De-coating

Melting scrap that is coated with a paint, polymer or lacquer increases the amount of oxidation and dross produced and consequently there are reduced recovery yields. Additionally, harmful emissions like dioxins, furans, nitrous oxides and volatile organic compounds can be generated which require additional equipment such as afterburners to treat. It has been shown that de-coating the scrap prior to charging increases recovery yield [11]. Recovered heat from exhaust gases has been used in rotary kilns to de-coat scrap and the calorific value can be returned to the furnace [244]. Furthermore, organic material present on scrap can be used as a fuel to supply the energy required to de-coat the material [51].

6.4. Electricity Generation

Methodologies and technologies have been developed to generate electricity from heat sources in other industries. These include Rankine cycles for water desalination and steel production [245] and Kalina cycles for cement production [246], steam generators from power generation plants [22], thermoelectric generators for silicon casting [247], among numerous others. The technology is chosen depending on the grade of heat. Most use expansion or the phase change of a fluid or gas to produce a rotary movement, like a turbine, to generate electricity. Electricity can be distributed throughout the site to reduce operating costs or can be introduced back to the grid to generate an income. Electricity generation from thermoelectric generators typically has a low recovery rate compared to other technologies [247] and installation capital costs of all technologies can be high.

Hybrid systems have been simulated where a radiative [219] or convective [248] recuperator was tied to a steam Rankine cycle. Gas turbines have been studied [249,250]. Caglayan and Caliskan [249] proposed a cogeneration system to generate electricity from a ceramic roller kiln using a combined heat and power unit. A 4.4 MW gas turbine running at an efficiency of around 20% was suggested. Montorsi, Milani, Stefani and Terzi [250] built upon this with numerical modelling and CFD analysis. They were able to predict ROI's and the reduction in fuel consumption. Even though kiln efficiency was increased and the electrical energy requirement was reduced, the proposal was not economically advantageous, and the benefit was marginal.

Peris, Navarro-Esbrí, Molés and Mota-Babiloni [251] used an organic Rankine cycle (ORC) to produce 18.51-21.79 kW and recover 128.19-179.87 kW of thermal power from the ceramic industry. The working fluid used to recover heat from exhaust gases was R245fa. The energy was transferred to the ORC module using thermal oil at 165 °C.

Regarding the primary aluminium industry, limited studies have been made to recover heat using indirect Rankine cycles [252] for exhaust gases and ORCs [253] for exhaust gases and cell walls. This technology is far from being commercialised and needs more work to assess whether it is economically viable.

7. Conclusion

In this paper, the historic and current processes for producing aluminium have been presented. Over the years, more energy efficient technology and methods have been developed and historically inefficient or environmentally unfriendly equipment is being upgraded as the understanding of the consequences of emissions are being more fully understood. It can be seen that the primary industry is the heaviest contributor to gaseous emissions, in particular the electrolysis process. Foresight to reducing these emissions can be seen by the proportion of hydroelectric plants providing power for the primary industry. Furthermore, the continued development of inert anodes and their imminent commercialisation in the primary industry is an exciting prospect especially considering the ability to mitigate a large proportion of the CO₂ produced. If this technology is implemented worldwide, a significant proportion of emissions will not only be prevented from the electrolysis process, but also the requirement for the extremely high impact process of manufacturing and consequent baking of carbon anodes for Prebake cells will be negated. The material choice for these inert anodes has been significantly researched.

The refining industry produces the highest proportion of problematic solid residues, in particular red mud, but SPL and salt slag produced by the primary and secondary industries is also a concern. Continued work must be done to ensure the hazardous nature of the solid by-products can be mitigated by producing a value added or inert product, not just ending in landfill.

The proportion of secondary metal production is increasing and is more environmentally friendly to produce. It is recognised that primary metal is still a necessity but both environmentally friendly primary and secondary smelters are of paramount importance. To increase the benefit, one energy efficiency and GHG reduction measure that can be introduced are WHR technologies. New technology is being developed constantly and real progress has been made in providing affordable and commercially advantageous products. As a major contributor of anthropogenic GHG emissions and a heavy energy consumer, the aluminium industry needs to take steps forward in sustainable procedures, particularly in light of the environmental impacts it causes.

In the refining industry, the processes that can be targeted are the digestion and calcination process steps. Already, steam is reused and heat exchangers are used for preheating incoming materials. Improving heat exchanger efficiency for preheating the slurry is an attractive concept, also potentially targeting exhaust gas energy content from calcination. Circulating fluid bed calciners have been developed to mitigate losses but off gases are still released.

A variety of furnace technologies and the rationale for their chosen application is described. It is interesting to review that furnaces are still designed by 'semi-empirical' methods and that continued work is ongoing to model furnace energy efficiency by CFD and numerical methods.

As the industry is so energy intensive, it is sensible to target the highest energy losses initially. There is a wide spectrum of temperatures seen across the entire process of aluminium procurement and a variety of equipment is readily available to access this spectrum. The combustion processes see high temperature and medium temperature ranges. Material choice required for high temperature applications can be costly, these high temperature streams can be diluted to bring the range into a more manageable spectrum. Table 10 describes a summary of commonly used WHR technology discussed throughout this paper and their applicable temperature ranges. A combination of these will be required to increase energy efficiency within the aluminium industry.

Table 10: A summary of WHR technology discussed and their applicable temperature ranges.

High Temperature Range ($>400^{\circ}\text{C}$)	Medium Temperature Range ($400-100^{\circ}\text{C}$)	Low Temperature Range ($<100^{\circ}\text{C}$)
<ul style="list-style-type: none"> • Ceramic recuperators • Heat pipes • Material preheating • Radiation/ convective/ hybrid recuperators • Regenerative/ recuperative burners • Rotary regenerators • Steam generation • Thermionic devices • Waste heat boilers 	<ul style="list-style-type: none"> • De-coating • Economisers • Heat pipes • Material preheating • Radiation/ convective/ hybrid recuperators • Recuperative burners • Rotary regenerators • Shell and tube • Thermo-compressors • Thermoelectric devices • Waste heat boilers 	<ul style="list-style-type: none"> • Air preheaters • Compact heat exchangers • Piezoelectric devices • Plate heat exchanger • Thermoelectric • RAC's • Shell and tube heat exchangers

A variety of heat exchangers have been developed to target specific heat streams, quality of waste heat and source and the choice depends on numerous factors. Air preheaters, including rotary regenerators and run around coils can be used to recover waste heat from exhaust gases. Compact heat exchangers can be applied when there are space limitations though pressure drop and the increased risk of fouling leading to reduced efficiency are considerations. Economisers are also used to target recovery from exhaust gases. Heat pipe heat exchangers are an extremely effective method of recovering heat and are, in particular, a promising technology due to their numerous advantageous properties described. Recuperators are one of the simplest methods of recovering waste heat, can be put in line with ducting so have a small footprint and come in many conformations and materials. Shell and tube heat exchangers can effectively transfer heat but have a larger footprint than other technologies and can suffer from corrosion and high pressure drop. Direct electrical conversion devices are providing an additional field to WHR, although current technology is yet to be fully tried and proven. Additional work is recommended in this area, particularly focusing on increasing efficiencies. Waste heat boilers tend to require a heat source from higher temperature ranges but are a

proven available technology. Thermo-compressors are extremely useful when steam is being generated and can be reused in a process, they are simple and effective.

Current and potential applications for technologies have been addressed and tend to be site specific. The main applications fall into three categories: space and district heating, process optimisation and electricity generation. With energy efficiency not only being a commercially advantageous situation but a global issue, these technologies, among other effective energy efficiency measures, must continue to be introduced and applied conscientiously throughout the aluminium industry.

8. Acknowledgements

The research presented in this paper has received funding by the European Union's projects Spire 2030, DREAM, and Horizon 2020, ETEKINA, under grant agreement No's 723641 and 768772.

Journal Pre-proof

9. References

- [1] United Nations Treaty Collection. Paris Agreement. 2015.
- [2] European Commission. 2030 climate & energy framework n.d.
https://ec.europa.eu/clima/policies/strategies/2030_en (accessed August 19, 2019).
- [3] European Commission. Energy Roadmap 2050. Luxemb Publ Off Eur Union 2012;20. doi:10.2833/10759.
- [4] Climate Change News. Hundreds of Extinction Rebellion activists face court, in summer of prosecutions 2019.
<https://www.climatechangenews.com/2019/07/15/hundreds-extinction-rebellion-activists-face-court-summer-prosecutions/> (accessed August 19, 2019).
- [5] Department for Business Energy & Industrial Strategy, Skidmore C. UK becomes first major economy to pass net zero emissions law 2019.
<https://www.gov.uk/government/news/uk-becomes-first-major-economy-to-pass-net-zero-emissions-law>.
- [6] Central Intelligence Agency. The World Factbook 2016-17. 2018.
- [7] Jouhara H, Olabi AG. Editorial: Industrial waste heat recovery. *Energy* 2018;160:1–2. doi:10.1016/j.energy.2018.07.013.
- [8] Agathokleous R, Panayiotou G, Aresti L, Argyrou MC, Georgiou GS, Jouhara H, et al. Waste Heat Recovery in the EU industry and proposed new technologies. *Energy Procedia* 2019;161:489–96. doi:10.1016/J.EGYPRO.2019.02.064.
- [9] Simeone A, Luo Y, Woolley E, Rahimifard S, Boër C. A decision support system for waste heat recovery in manufacturing. *CIRP Ann* 2016;65:21–4. doi:10.1016/J.CIRP.2016.04.034.
- [10] Brown TJ, Idoine NE, Raycraft ER, Shaw RA, Hobbs SF, Everett P, et al. *World Mineral Production 2012-2016*. Nottingham: 2018.
- [11] Schlesinger ME. *Aluminium Recycling*. New Editio. Taylor & Francis Inc; 2013.
- [12] Kvande H. Occurrence and Production of Aluminum. *Encycl Inorg Bioinorg Chem* 2015:1–10. doi:10.1002/9781119951438.eibc2350.
- [13] Liu G, Müller DB. Addressing sustainability in the aluminum industry: A critical review of life cycle assessments. *J Clean Prod* 2012;35:108–17. doi:10.1016/j.jclepro.2012.05.030.
- [14] The Aluminium Association. *Aluminium Recycling* n.d.
<https://www.aluminum.org/industries/production/recycling> (accessed August 19, 2019).
- [15] Kvande H. The aluminum smelting process. *J Occup Environ Med* 2014;56:2–4. doi:10.1097/JOM.0000000000000154.
- [16] Bertram M, Martchek KJ, Rombach G. Material flow analysis in the aluminum industry. *J Ind Ecol* 2009;13:650–4. doi:10.1111/j.1530-9290.2009.00158.x.
- [17] McKenna RC, Norman JB. Spatial modelling of industrial heat loads and recovery potentials in the UK. *Energy Policy* 2010;38:5878–91. doi:10.1016/J.ENPOL.2010.05.042.
- [18] Menzie WD, Barry JJ, Bleiwas DI, Bray EL, Goonan TG, Matos G. The global flow of aluminum from 2006 through 2025. *Sci a Chang World* 2010:1–78. doi:10.1016/S0020-1693(00)91289-1.
- [19] Das S. Achieving Carbon Neutrality in the Global Aluminum Industry. *J Miner Met Mater Soc* 2012;64:285–90.
- [20] Luo Z, Soria A. Prospective study of the world aluminium industry. vol. 22951. 2008. doi:10.2791/36024.
- [21] Steinfeld A. High-temperature solar thermochemistry for CO₂ mitigation in the extractive metallurgical industry. *Energy* 1997;22:311–6. doi:10.1016/S0360-

- 5442(96)00103-X.
- [22] Jouhara H, Khordehghah N, Almahmoud S, Delpech B, Chauhan A, Tassou SA. Waste heat recovery technologies and applications. *Therm Sci Eng Prog* 2018;6:268–89. doi:10.1016/J.TSEP.2018.04.017.
- [23] The “ Age of Aluminium ” Out of Acorns Grow Big Trees. *Alum Int Today* 2017:2–3.
- [24] Royal Society of Chemistry. Periodic table- Aluminium n.d. <http://www.rsc.org/periodic-table/element/13/aluminium> (accessed August 19, 2019).
- [25] Laparra M. A portrait of aluminium , metal of dream and modernity 2015:1–14.
- [26] UC Rusal. The History of Aluminium Industry n.d. https://www.aluminiumleader.com/history/industry_history/ (accessed May 8, 2019).
- [27] Wedepohl K H. The composition of the continental crust. *Geochim Cosmochim Acta* 1995;59:1217–32. doi:10.1016/B978-0-08-095975-7.00301-6.
- [28] Zhao R, Nowicki C, Gosselin L, Duchesne C. Energy and exergy inventory in aluminum smelter from a thermal integration point-of-view. *Int J ENERGY Res* 2016. doi:10.1002/er.3508.
- [29] Cullen JM, Allwood JM. Mapping the Global Flow of Aluminium: from Liquid Aluminium to Fabricated Goods. *Environ Sci Technol* 2013;47:1–17. doi:10.1021/es304256s.
- [30] Milford RL, Allwood JM, Cullen JM. Assessing the potential of yield improvements, through process scrap reduction, for energy and CO₂ abatement in the steel and aluminium sectors. *Resour Conserv Recycl* 2011;55:1185–95. doi:10.1016/J.RESCONREC.2011.05.021.
- [31] Haraldsson J, Johansson MT. Review of measures for improved energy efficiency in production-related processes in the aluminium industry – From electrolysis to recycling. *Renew Sustain Energy Rev* 2018. doi:10.1016/j.rser.2018.05.043.
- [32] World Aluminium. Global Aluminium Cycle 2019 n.d. <http://www.world-aluminium.org/statistics/massflow/> (accessed August 2, 2019).
- [33] Kvande H, Drabløs PA. The aluminum smelting process and innovative alternative technologies. *J Occup Environ Med* 2014;56:23–32. doi:10.1097/JOM.0000000000000062.
- [34] Klopogge JT, Duong L V., Wood BJ, Frost RL. XPS study of the major minerals in bauxite: Gibbsite, bayerite and (pseudo-)boehmite. *J Colloid Interface Sci* 2006;296:572–6. doi:10.1016/J.JCIS.2005.09.054.
- [35] Plunkert, A P. Bauxite and Alumina. *US Geol Surv Miner Handb* 2001.
- [36] Bray E. Bauxite Mineral Commodity Summary 2018;1:2017–8.
- [37] Tsakiridis PE. Aluminium salt slag characterization and utilization - A review. *J Hazard Mater* 2012;217–218:1–10. doi:10.1016/j.jhazmat.2012.03.052.
- [38] Donoghue AM, Frisch N, Olney D. Bauxite mining and alumina refining: Process description and occupational health risks. *J Occup Environ Med* 2014;56. doi:10.1097/JOM.0000000000000001.
- [39] Balomenos E, Gianopoulou I, Panias D, Paspaliaris I, Nikolaos A, Perry K. Efficient and Complete Exploitation of the Bauxite Residue (Red Mud) Produced in the Bayer Process. *Eur Metall Conf* 2011;Volume 3:745–57. doi:http://dx.doi.org/10.1016/j.phanu.2013.11.097.
- [40] Kaußen FM, Friedrich B. Methods for Alkaline Recovery of Aluminum from Bauxite Residue. *J Sustain Metall* 2016;2:353–64. doi:10.1007/s40831-016-0059-3.
- [41] Balomenos E, Panias D, Paspaliaris I. Energy and exergy analysis of the primary aluminum production processes: A review on current and future sustainability. *Miner Process Extr Metall Rev* 2011;32:69–89. doi:10.1080/08827508.2010.530721.
- [42] Cusano G, Gonzalo MR, Farrell F, Remus R, Roudier S, Sancho LD. Best Available

- Techniques (BAT) Reference Document for the Non-Ferrous Metals Industries. 2017. doi:10.2760/8224.
- [43] ABB. Alunorte alumina plant, bauxite mine and pipeline in Brazil n.d. <https://new.abb.com/control-systems/industry-specific-solutions/aluminium/800xa-for-alunorte-alumina-plant-in-brazil> (accessed September 2, 2019).
- [44] Liang F, Sayed M, Al-Muntasheri GA, Chang FF, Li L. A comprehensive review on proppant technologies. *Petroleum* 2016;2:26–39. doi:10.1016/j.petlm.2015.11.001.
- [45] Grjotheim K, Kvande H. Introduction to Aluminium Electrolysis: Understanding the Hall-Heroult Process. 2nd ed. Beuth Verlag; 1993.
- [46] Prasad S. Studies on the Hall-Heroult Aluminum Electrowinning Process. *J Braz Chem Soc* 2000;11:245–51. doi:10.1590/S0103-50532000000300008.
- [47] Tabereaux A. Prebake cell technology: A global review. *JOM* 2000;52:23–9. doi:10.1007/s11837-000-0043-y.
- [48] Lumley R, Metson J, Kvande H, Wallace G, Grandfield JF, Otarawanna S, et al. *Fundamentals of aluminium metallurgy*. 1st ed. Woodhead Publishing Limited; 2011.
- [49] Das SK, Yin W. The Worldwide Aluminum Economy: The Current State of the Industry 2007:57–63. doi:10.1007/s11837-007-0142-0.
- [50] World Aluminium. Primary Aluminium Production n.d. <http://www.world-aluminium.org/statistics/primary-aluminium-production/#map> (accessed August 2, 2019).
- [51] Capuzzi S, Timelli G. Preparation and Melting of Scrap in Aluminum Recycling: A Review. *Metals (Basel)* 2018;8:24. doi:10.3390/met8040249.
- [52] Vas K. Using Technology and Automation for Enhanced Returns in Aluminium Scrap Processing. 21st Int. Recycl. Alum., 2013.
- [53] JBMI Group Ltd. n.d. <https://www.jbmi.com> (accessed October 14, 2019).
- [54] Kuchariková L, Tillová E, Bokůvka O. Recycling and properties of recycled aluminium alloys used in the transportation industry. *Transp Probl* 2016;11:117–22. doi:10.20858/tp.2016.11.2.11.
- [55] Canby TY. Aluminium, the magic metal. *Natl Geogr Soc* 1978.
- [56] Metroalloys. Aluminium sows n.d. <https://www.metroalloys.com/images/AlumRSI.jpg> (accessed August 5, 2019).
- [57] Benedyk J. AK's Greenfield Casthouse Produces Jumbo Billet and Slab to Supply Aerospace AI Globally. *Light Met Age* n.d. <https://www.lightmetage.com/news/industry-news/casthouse/article-aks-greenfield-casthouse-produces-jumbo-billet-and-slab-to-supply-aerospace-al-globally/> (accessed August 5, 2019).
- [58] Hui Tai Technology. Aluminium billets casting table n.d. http://www.aluminiumfurnace.com/products_info.asp?id=6 (accessed August 5, 2019).
- [59] Nicromet. Transport n.d. <http://www.nicromet.pl/en/products/transport> (accessed August 5, 2019).
- [60] Davis JR. Aluminium and Aluminium Alloys. *Alloy Underst Basics* 2001:351–416. doi:10.1361/autb2001p351.
- [61] Starke EA, Mridha S. Aluminum Alloys: Alloy, Heat Treatment, and Temper Designation. *Ref Modul Mater Sci Mater Eng* 2016. doi:10.1016/B978-0-12-803581-8.02553-4.
- [62] The Aluminium Association. International Alloy Designations and Chemical Composition Limits for Wrought Aluminum and Wrought Aluminum Alloys With Support for On-line Access From: Aluminum Extruders Council Use of the Information. *Alum Assoc Arlington, Virginia* 2015:31.
- [63] Nunez P, Jones S. Cradle to gate: life cycle impact of primary aluminium production.

- Int J Life Cycle Assess 2016;21:1594–604. doi:10.1007/s11367-015-1003-7.
- [64] Farjana SH, Huda N, Mahmud MAP. Impacts of aluminum production: A cradle to gate investigation using life-cycle assessment. *Sci Total Environ* 2019;663:958–70. doi:10.1016/J.SCITOTENV.2019.01.400.
- [65] PE Americas. Life Cycle Impact Assessment of Aluminum Beverage Cans. Final Report 2010:1–127.
- [66] World Aluminium. Metallurgical Alumina Refining Energy Intensity n.d. <http://www.world-aluminium.org/statistics/metallurgical-alumina-refining-energy-intensity/> (accessed August 7, 2019).
- [67] World Aluminium. Metallurgical Alumina Refining Fuel Consumption n.d. <http://www.world-aluminium.org/statistics/metallurgical-alumina-refining-fuel-consumption/> (accessed August 7, 2019).
- [68] Chislock MF, Doster E, Zitomer RA, Wilson AE. Eutrophication: Causes, consequences, and controls in aquatic ecosystems. *Nat Educ Knowl* 2013;4.
- [69] Andersson-Skold Y, Grennfelt P, Pleijel K. Photochemical ozone creation potentials: A study of different concepts. *J Air Waste Manag Assoc* 1992;42:1152–8. doi:10.1080/10473289.1992.10467060.
- [70] Buxmann K, Koehler A, Thylmann D. Water scarcity footprint of primary aluminium. *Int J Life Cycle Assess* 2016;21:1605–15. doi:10.1007/s11367-015-0997-1.
- [71] Khairul MA, Zanganeh J, Moghtaderi B. The composition, recycling and utilisation of Bayer red mud. *Resour Conserv Recycl* 2019;141:483–98. doi:10.1016/J.RESCONREC.2018.11.006.
- [72] Tang WC, Wang Z, Donne SW, Forghani M, Liu Y. Influence of red mud on mechanical and durability performance of self-compacting concrete. *J Hazard Mater* 2019;379:120802. doi:10.1016/j.jhazmat.2019.120802.
- [73] Li Y, Min X, Ke Y, Liu D, Tang C. Preparation of red mud-based geopolymer materials from MSWI fly ash and red mud by mechanical activation. *Waste Manag* 2019;83:202–8. doi:10.1016/j.wasman.2018.11.019.
- [74] Xue B, Wei B, Ruan L, Li F, Jiang Y, Tian W, et al. The influencing factor study on the extraction of gallium from red mud. *Hydrometallurgy* 2019;186:91–7. doi:10.1016/j.hydromet.2019.04.005.
- [75] Xu X, Song J, Li Y, Wu J, Liu X, Zhang C. The microstructure and properties of ceramic tiles from solid wastes of Bayer red muds. *Constr Build Mater* 2019;212:266–74. doi:10.1016/j.conbuildmat.2019.03.280.
- [76] Lu G, Zhang T, Ma L, Wang Y, Zhang W, Zhang Z, et al. Utilization of Bayer red mud by a calcification–carbonation method using calcium aluminate hydrate as a calcium source. *Hydrometallurgy* 2019;188:248–55. doi:10.1016/j.hydromet.2019.05.018.
- [77] Chen R, Cai G, Dong X, Mi D, Puppala AJ, Duan W. Mechanical properties and micro-mechanism of loess roadbed filling using by-product red mud as a partial alternative. *Constr Build Mater* 2019;216:188–201. doi:10.1016/j.conbuildmat.2019.04.254.
- [78] Mukiza E, Zhang LL, Liu X, Zhang N. Utilization of red mud in road base and subgrade materials: A review. *Resour Conserv Recycl* 2019;141:187–99. doi:10.1016/j.resconrec.2018.10.031.
- [79] Ghenai C, Inayat A, Shanableh A, Al-Sarairah E, Janajreh I. Combustion and emissions analysis of Spent Pot lining (SPL) as alternative fuel in cement industry. *Sci Total Environ* 2019;684:519–26. doi:10.1016/j.scitotenv.2019.05.157.
- [80] Holywell G, Breault R. An Overview of Useful Methods to Treat, Recover, or Recycle Spent Potlining. *JOM* 2013;65. doi:10.1007/s11837-013-0769-y.

- [81] Paraskevas D, Kellens K, Van De Voorde A, Dewulf W, Duflou JR. Environmental Impact Analysis of Primary Aluminium Production at Country Level. *Procedia CIRP* 2016;40:209–13. doi:10.1016/j.procir.2016.01.104.
- [82] Khaji K, Al Qassemi M. The Role of Anode Manufacturing Processes in Net Carbon Consumption. *Metals (Basel)* 2016;6:128. doi:10.3390/met6060128.
- [83] World Aluminium. Perfluorocarbon (PFC) Emissions n.d. <http://www.world-aluminium.org/statistics/perfluorocarbon-pfc-emissions/> (accessed August 2, 2019).
- [84] Huglen R, Kvande H. Global Considerations of Aluminium Electrolysis on Energy and the Environment. *Light Met* 1994;373–80.
- [85] Aluminium W. Fluoride Emissions n.d. <http://www.world-aluminium.org/statistics/fluoride-emissions/> (accessed August 22, 2019).
- [86] Yang YJ, Hyland M, Wang ZW, Seal C. Modelling HF generation in aluminium reduction cell. *Can Metall Q* 2015;54:149–60. doi:10.1179/1879139514Y.00000000169.
- [87] Hagen M, Schricker B. Fume Treatment Systems Based on RTO Technology for Carbon Baking Furnaces. In: Sadler B, editor. *Light Met.* 2013, 2013, p. 1317–22. doi:10.1007/978-3-319-65136-1_222.
- [88] Crawford CB, Quinn B. 6 - The interactions of microplastics and chemical pollutants. In: Crawford CB, Quinn B, editors. *Microplastic Pollut.*, Elsevier; 2017, p. 131–57. doi:https://doi.org/10.1016/B978-0-12-809406-8.00006-2.
- [89] Oskar Commission. Emissions and Discharges of Polycyclic Aromatic Hydrocarbons (PAHs) from Primary Aluminium Electrolysis, Soederberg Technology 2002:25.
- [90] Meshram A, Singh KK. Recovery of valuable products from hazardous aluminum dross: A review. *Resour Conserv Recycl* 2018;130:95–108. doi:10.1016/j.resconrec.2017.11.026.
- [91] Environmental Protection Agency. European waste catalogue and hazardous waste list. 2002.
- [92] Lorber KE, Antrekowitsch H. Treatment and disposal of residues from aluminium dross recovery. *2nd Int Conf Hazard Ind Waste Manag* 2010.
- [93] Manfredi O, Wuth W, Bohlinger I. Characterizing the physical and chemical properties of aluminum dross. *JOM* 1997;49:48–51. doi:10.1007/s11837-997-0012-9.
- [94] Beheshti R, Moosberg-Bustnes J, Akhtar S, Aune RE. Black Dross Processing: Utilization of Black Dross in the Production of a Ladle Fluxing Agent. *J Sustain Metall* 2017;3:265–73. doi:10.1007/s40831-016-0076-2.
- [95] Mullinger P, Jenkins B. *Industrial and Process Furnaces*. 1st ed. 7506 Butterworth-Heinemann, Architectural Press; 2008.
- [96] U.S. Department of Energy. U.S. Energy Requirements for Aluminum Production: Historical Perspective, Theoretical Limits and Current Practices. *Ind Technol Progr Energy Effic Renew Energy* 2007:150.
- [97] Kashkhan. Hall-Heroult Cell 2008. <https://commons.wikimedia.org/wiki/File:Hall-heroult-kk-2008-12-31.png> (accessed August 2, 2019).
- [98] Nowicki C, Gosselin L. An overview of opportunities for waste heat recovery and thermal integration in the primary aluminum industry. *Jom* 2012;64:990–6. doi:10.1007/s11837-012-0367-4.
- [99] Johnson, Ilona ; Choate, William T. ; Davidson A. Waste Heat Recovery: Technology Opportunities in the US Industry - prepared by Bcs, Incorporated. *US Dep Energy - Ind Technol Progr* 2008:1–112.
- [100] Oumarou N, Kocaefe D, Kocaefe Y, Morais B. A Dynamic Process Model for Simulating Horizontal Anode Baking Furnaces 2013;34:2071–7.
- [101] Grégoire F, Gosselin L. Comparison of three combustion models for simulating anode

- baking furnaces. *Int J Therm Sci* 2018;129:532–44. doi:10.1016/j.ijthermalsci.2018.04.006.
- [102] Gusberti V, Meier MW, Sulger PO, Keller F, Severo DS. Specific Energy Consumption in Anode Bake Furnaces. *Essent Readings Light Met* 2016;408–13. doi:10.1007/978-3-319-48200-2_55.
- [103] Tajik AR, Shamim T, Zaidani M, Abu Al-Rub RK. The effects of flue-wall design modifications on combustion and flow characteristics of an aluminum anode baking furnace-CFD modeling. *Appl Energy* 2018;230:207–19. doi:10.1016/j.apenergy.2018.08.078.
- [104] Zhou P, Mei C, Zhou J, Zhou N, Xu Q. Simulation of the influence of the baffle on flowing field in the anode baking ring furnace. *J Cent South Univ Technol* 2002;9:208–11. doi:10.1007/s11771-002-0028-9.
- [105] Chaodong L, Yinhe C, Shanhong Z, Haifei X, Yi S. Research and Application for Large Scale, High Efficiency and Energy Saving Baking Furnace Technology, 2018, p. 1419–23. doi:10.1007/978-3-319-72284-9_185.
- [106] Gundersen Ø, Balchen JG. Modeling and simulation of an anode carbon baking furnace. *Model Identif Control* 1995;16:3–33. doi:10.4173/mic.1995.1.1.
- [107] S Severo D, Gusberti V, C V Pinto E. Advanced 3D modelling for anode baking furnaces. *TMS Light Met* 2005.
- [108] Keller F, Mannweiler U, Severo D. Computational modeling in anode baking 2006:1–12.
- [109] Ordronneau F, Gendre M, Pomerleau L, Backhouse N, Berkovich A, Huang X. Meeting the Challenge of Increasing Anode Baking Furnace Productivity, 2011, p. 865–70. doi:10.1002/9781118061992.ch148.
- [110] Grégoire F, Gosselin L, Alamdari H. Sensitivity of Carbon Anode Baking Model Outputs to Kinetic Parameters Describing Pitch Pyrolysis. *Ind Eng Chem Res* 2013;Ind. Eng.:4465–4474. doi:10.1021/ie3030467.
- [111] Baiteche M, Kocaefe D, Kocaefe Y, Marceau D, Morais B, Lafrance J. Description and Applications of a 3D Mathematical Model for Horizontal Anode Baking Furnaces. *Light Met* 2015 2015:1115–20. doi:10.1002/9781119093435.ch187.
- [112] Kocaefe Y, Oumarou N, Baiteche M, Kocaefe D, Morais B, Gagnon M. Use of mathematical modelling to study the behavior of a horizontal anode baking furnace. *TMS Light Met* 2013:1139–44.
- [113] El Ghaoui Y, Besson S, Drouet Y, Morales F, Tomsett A, Gendre M, et al. Anode Baking Furnace Fluewall Design Evolution: A Return of Experience of Latest Baffleless Technology Implementation, 2016, p. 941–5. doi:10.1007/978-3-319-48251-4_158.
- [114] Zaidani M, Al-Rub RA, Tajik AR, Shamim T. 3D Multiphysics model of the effect of flue-wall deformation on the anode baking homogeneity in horizontal flue carbon furnace. *Energy Procedia* 2017;142:3982–9. doi:10.1016/j.egypro.2017.12.307.
- [115] Padamata K, Yasinskiy AS, Polyakov P V. Progress of Inert Anodes in Aluminium Industry: Review. *J Sib Fed Univ Chem* 2018;11:18–30. doi:10.17516/1998-2836-0055.
- [116] de Nora V. Inert anodes are knocking at the door of aluminium producers 2001.
- [117] Augustin C, Sen UA. Green anode for aluminium production. *Int Conf Alum* 1998;2:173–6.
- [118] Du J, Wang B, Liu Y, Fang Z, Hu P. Study on the bubble behaviour and anodic overvoltage of NiFe₂O₄ ceramic based inert anode. *Light Met* 2015:1193–7.
- [119] Alder H. Electrolysis of a molten charge using inconsumable electrodes. 3960678US, 1976.

- [120] Issaeva L, Haarberg GM, Xiao H, Thonstad J. The Interaction Between Tin Oxide and Cryolite-Alumina Melts. *ECS Proc Vol 1994;1994-13:568-77*. doi:10.1149/199413.0568pv.
- [121] Zaikov YP. Ceramic properties of electrodes based on NiO-Li₂O and their solubility in cryolite alumina melts. *Vill. AI Symp., Žiar Nad Hronom, Slovakia: 1995, p. 239-41*.
- [122] Glucina M, Hyland M. Laboratory testing of aluminium bronze as an inert anode for aluminium electrolysis. *TMS Light Met 2005:523-8*.
- [123] Nguyen T, De Nora V. De Nora oxygen evolving inert metallic anode. *TMS Light Met 2006;2006:385-90*.
- [124] Simakov DA. Progress in the development of reduction technology with inert anodes. *Proc. Non Ferr. Met., 2002, p. 363*.
- [125] Helle S, Pedron M, Assouli B, Davis B, Guay D, Roué L. Structure and high-temperature oxidation behaviour of Cu-Ni-Fe alloys prepared by high-energy ball milling for application as inert anodes in aluminium electrolysis. *Corros Sci 2010;52:3348-55*. doi:10.1016/j.corsci.2010.06.011.
- [126] Goupil G, Helle S, Davis B, Guay D, Roué L. Anodic behavior of mechanically alloyed Cu-Ni-Fe and Cu-Ni-Fe-O electrodes for aluminum electrolysis in low-temperature KF-AlF₃ electrolyte. *Electrochim Acta 2013;112:176-82*. doi:10.1016/j.electacta.2013.08.157.
- [127] Ray SP, Rapp RA. Method of making composition suitable for use as inert electrode having good electrical conductivity and mechanical properties. 4584172US, 1986.
- [128] Ray SP, Rapp RA. Composition suitable for use as inert electrode having good electrical conductivity and mechanical properties. 4454015US, 1984.
- [129] Liu JY, Li ZY, Tao YQ, Zhang D, Zhou KC. Phase evolution of 17(Cu-10Ni)-(NiFe₂O₄-10NiO) cermet inert anode during aluminum electrolysis. *Trans Nonferrous Met Soc China (English Ed 2011;21:566-72*. doi:10.1016/S1003-6326(11)60752-8.
- [130] Tian Z-L, Lai Y-Q, Zhang G, Qin Q-W, Wang J-F, Li J, et al. Preparation of NiFe₂O₄-Cu based cermet inert anodes in aluminium electrolysis 2003;13.
- [131] Feng LC, Xie N, Shao WZ, Zhen L, Ivanov V V. Exploring Cu₂O/Cu cermet as a partially inert anode to produce aluminum in a sustainable way. *J Alloys Compd 2014;610:214-23*. doi:10.1016/j.jallcom.2014.04.198.
- [132] Zhang L, Li ZY, Zhou KC, Li J, Lai YQ. Sintering of the NiFe₂O₄-10NiO/xNi cermet. *J Cent South Univ Technol (English Ed 2006;13:332-6*. doi:10.1007/s11771-006-0044-2.
- [133] Rapp RA. Method featuring a non-consumable anode for the electrowinning of aluminium. 6039862US, 2000.
- [134] Alder H. Process for the electrolysis of a molten charge using inconsumable bi-polar electrodes. 3930967US, 1976.
- [135] Haarberg GM, Kvalheim E, Ratvik AP, Xiao SJ, Mokkelbost T. Depolarised gas anodes for aluminium electrowinning. *Trans Nonferrous Met Soc China (English Ed 2010;20:2152-4*. doi:10.1016/S1003-6326(09)60434-9.
- [136] Lassagne O, Gosselin L, Désilets M, Iliuta MC. Techno-economic study of CO₂ capture for aluminum primary production for different electrolytic cell ventilation rates. *Chem Eng J 2013;230:338-50*. doi:10.1016/j.cej.2013.06.038.
- [137] Mathisen A, Sørensen H, Eldrup N, Skagestad R, Melaaen M, Müller GI. Cost optimised CO₂ capture from aluminium production. *Energy Procedia 2014;51:184-90*. doi:10.1016/j.egypro.2014.07.021.
- [138] Jilvero H, Mathisen A, Eldrup NH, Normann F, Johnsson F, Müller GI, et al. Techno-economic analysis of carbon capture at an aluminum production plant - Comparison of post-combustion capture using MEA and Ammonia. *Energy Procedia 2014;63:6590-*

601. doi:10.1016/j.egypro.2014.11.695.
- [139] Den Hond R, Hiralal I, Rijkeboer A. Alumina yield in the Bayer process past, present and prospects. *Essent Readings Light Met* 2017;1:528–33. doi:10.1007/978-3-319-48176-0.
- [140] Haneman B, Wang A. Optimising Digestion Flash Tank Design for the Alumina Industry. 9th Int. Alumina Qual. Work., 2012, p. 127–31.
- [141] Farrokh M. Thermodynamic Process Modeling and Simulation of a Diaspore Bauxite Digestion Process. 2013.
- [142] Kumaresan T, Thakre S, Basu B, Kaple K, Gupta H, Bandi A, et al. Performance Improvement of Alumina Digestors. 7th Int Conf CFD Miner Process Ind 2009:1–6.
- [143] Moore D. Design Features of Rotary Kilns 2012.
- [144] Perander LM, Gasafi E, Scarsella A. Cost and Energy Efficiency Improvement in Alumina Calcination n.d.
- [145] Missalla M. Significant Improvement of Energy Efficiency at Alunorte's Calcination Facility 2016:1–1407. doi:10.1007/978-3-319-48160-9_27.
- [146] Raahauge BE, Devarajan N. Experience with particle breakdown in gas suspension calciners n.d.:1–10.
- [147] Marsh C. CFD Modelling of Alumina Calciner Furnaces. 7th Int Conf CFD Miner Process Ind 2009:2007–10.
- [148] Bratu V, Gaba A, Stoian EV, Anghelina FV. Natural Gas Consumption Reducing in Aluminum Melting Furnaces by Heat Recovery of Flue. *Sci Bull Valahia Univ - Mater Mech* 2016;14:17–22. doi:10.1515/bsmm-2016-0003.
- [149] U.S. Department of Energy. Waste Heat Reduction and Recovery for Improving Furnace Efficiency, Productivity and Emissions Performance 2004.
- [150] Dispinar D. Determination of Metal Quality of Aluminium and Its Alloys. 2005.
- [151] Khoei AR, Masters I, Gethin DT. Numerical modelling of the rotary furnace in aluminium recycling processes. *J Mater Process Technol* 2003;139:567–72. doi:10.1016/S0924-0136(03)00538-7.
- [152] Zhou B, Yang Y, Reuter MA, Boin UMJ. Modelling of aluminium scrap melting in a rotary furnace. *Miner Eng* 2006;19:299–308. doi:10.1016/J.MINENG.2005.07.017.
- [153] Khoei AR, Masters I, Gethin DT. Design optimisation of aluminium recycling processes using Taguchi technique. *J Mater Process Technol* 2002;127:96–106. doi:10.1016/S0924-0136(02)00273-X.
- [154] Faridabad Furnace Manufacturer. Aluminium Melting Rotary Furnace n.d. <https://faridabadfurnacemanufacturer.wordpress.com/category/aluminium-melting-rotary-furnace/> (accessed August 8, 2019).
- [155] Ünlü N, Drouet MG. Comparison of salt-free aluminum dross treatment processes. *Resour Conserv Recycl* 2002;36:61–72. doi:10.1016/S0921-3449(02)00010-1.
- [156] Melting Solutions. Tilting Rotary Furnace n.d. <http://www.meltingsolutions.co.uk/tilting-rotary-furnace/> (accessed August 22, 2019).
- [157] Altek, Mechatherm. <https://www.altek-al.com/tilting-rotary-furnaces.html> n.d. <https://www.altek-al.com/tilting-rotary-furnaces.html> (accessed August 2, 2019).
- [158] Hassan MI, Al Kindi R. Feasibility Study of Regenerative Burners in Aluminum Holding Furnaces. *JOM* 2014;66:1603–11. doi:10.1007/s11837-014-1110-0.
- [159] Dai X, Jolly M. Potential energy savings by application of the novel CRIMSON aluminium casting process. *Appl Energy* 2012;89:111–6. doi:10.1016/J.APENERGY.2010.12.029.
- [160] Wang J, Lan S, Li W. Numerical simulation and process optimization of an aluminum holding furnace based on response surface methodology and uniform design. *Energy* 2014;72:521–35. doi:10.1016/J.ENERGY.2014.05.077.

- [161] Carmona M, Cortés C. Analysis of the thermal performance and convection effects in an aluminum holding furnace using CFD. *Appl Therm Eng* 2015;76:484–95. doi:10.1016/j.applthermaleng.2014.11.044.
- [162] Acevedo L, Usón S, Uche J. Exergy transfer analysis of an aluminum holding furnace. *Energy Convers Manag* 2015;89:484–96. doi:10.1016/J.ENCONMAN.2014.10.021.
- [163] Insertec. Chamber Reverb Furnace n.d. <https://www.insertec-store.com/en/industrial-furnaces/aluminium-recycling-furnaces/holding-alloying/chamber-reverb-furnace.html> (accessed August 13, 2019).
- [164] Rooy E. Aluminum dross: Liability into opportunity. *Light Met Age* 1995;53.
- [165] Otto-Junker. Coreless induction furnace n.d. <https://www.otto-junker.com/en/products-technologies/furnaces-plants-for-aluminium-and-aluminium-based-alloys/foundry-and-casthouse/medium-frequency-coreless-induction-furnaces/> (accessed August 20, 2019).
- [166] Grandfield JF. Ingot casting and casthouse metallurgy of aluminium and its alloys. *Fundam Alum Metall Prod Process Appl* 2010:83–140. doi:10.1533/9780857090256.1.83.
- [167] T Masters and Sons Ltd. <https://www.tmasters.co.uk/ingotCastingMachines.php> n.d.
- [168] Worswick Engineering Ltd. <http://www.worswick.com/castingmachines.html> n.d. <http://www.worswick.com/castingmachines.html> (accessed August 2, 2019).
- [169] Melting Solutions. Ingot casting machines n.d. <http://www.meltingsolutions.co.uk/ingot-casting-machines/> (accessed September 12, 2019).
- [170] Pelayo R. Direct Chill and Fusion Casting of Aluminum Alloys. 2012.
- [171] Prasad A, Taylor JA, Bainbridge IF. The Measurement of Heat Flow Within a DC Casting Mould. In: Grandfield JF, Eskin DG, editors. *Essent. Readings Light Met. Vol. 3 Cast Shop Alum. Prod.*, Cham: Springer International Publishing; 2016, p. 659–64. doi:10.1007/978-3-319-48228-6_82.
- [172] Caron E, Baserinia A, O. Pelayo R, C. Weckman D, Wells M. Primary Cooling Heat Transfer during the Direct-Chill Casting of Aluminum Alloy AA6111, 2012, p. 1483–92. doi:10.1007/978-3-319-48761-8_225.
- [173] Yang F, Yu Q, Zuo Z, Hou L. Thermodynamic analysis of waste heat recovery of aluminum dross in electrolytic aluminum industry. *Energy Sources, Part A Recover Util Environ Eff* 2019:1–13. doi:10.1080/15567036.2019.1634163.
- [174] Sun Y, Zhang Z, Liu L, Wang X. Heat recovery from high temperature slags: A review of chemical methods. *Energies* 2015;8:1917–35. doi:10.3390/en8031917.
- [175] *Light Metal Age*. Harsco Acquires Altek n.d. <https://www.lightmetage.com/news/marketplace/supplier-news/harsco-acquires-altek/> (accessed August 8, 2019).
- [176] Altek. Alusalt salt slag recycling processing n.d. <https://www.altek-al.com/alusalt-salt-slag-recycling-processing.html>.
- [177] Bright M, Ilinca F, Héту J-F, Ajersch F, Saliba C, Vild C. Fluid modeling of the flow and free surface parameters in the metallurgical lotuss system. *TMS Annu Meet* 2009.
- [178] Griffiths WD, McCartney DG. The effect of electromagnetic stirring during solidification on the structure of Al-Si alloys. *Mater Sci Eng* 1996;216:47–60.
- [179] Bojarevičs A, Beinerts T, Gelfgat Y, Kaldre I. Permanent magnet centrifugal pump for liquid aluminium stirring. *Int J Cast Met Res* 2016;29:154–7. doi:10.1080/13640461.2015.1120998.
- [180] Bojarevičs A, Baranovskis R, Kaldre I, Milgravis M, Beinerts T. Two cylinder permanent magnet stirrer for liquid metals. *IOP Conf Ser Mater Sci Eng* 2017;228. doi:10.1088/1757-899X/228/1/012022.

- [181] Altek. The Rise of ALTEK ' s Side Mounted Electromagnetic Stirrers – the installation of the future n.d. <https://www.altek-al.com/pdfs/ems-side-stirrer-editorial.pdf> (accessed August 12, 2019).
- [182] Melting Solutions. Charging machines n.d. <http://www.meltingsolutions.co.uk/charging-machines/> (accessed August 12, 2019).
- [183] Tenorio JAS, Espinosa DCR. Effect of salt/oxide interaction on the process of aluminum recycling. *J Light Met* 2002;2:89–93. doi:10.1016/S1471-5317(02)00027-5.
- [184] Xiao Y, Reuter MA, Boin UD. Aluminium Recycling and Environmental Issues of Salt Slag Treatment. *J Environ Sci Heal Part A* 2005;40:1861–75. doi:10.1080/10934520500183824.
- [185] Broström M, Enestam S, Backman R, Mäkelä K. Condensation in the KCl-NaCl system. *Fuel Process Technol* 2013;105:142–8. doi:10.1016/j.fuproc.2011.08.006.
- [186] Talbot DEJ, Granger DA. Secondary hydrogen porosity in aluminium. *J Inst Met* 1963;92:290–7.
- [187] Engh TA, Pedersen T. Removal of Hydrogen from Molten Aluminium by Gas Purging. In: Grandfield JF, Eskin DG, editors. *Essent. Readings Light Met. Vol. 3 Cast Shop Alum. Prod.*, Cham: Springer International Publishing; 2016, p. 218–25. doi:10.1007/978-3-319-48228-6_26.
- [188] Kopeliovich D. Degassing Treatment of Molten Aluminum Alloys n.d. http://www.substech.com/dokuwiki/doku.php?id=degassing_treatment_of_molten_aluminum_alloys (accessed October 14, 2019).
- [189] Friedrich B, Kräutlein C, Krone K. Melt Treatment of Copper and Aluminium - The Complex Step Before Casting. *Contin Cast* 2006;1–22. doi:10.1002/9783527607969.ch1.
- [190] Schwaiger R, Gamweger K. Porous plugs - A new generation of degassing technology in aluminium foundry ladles 2006;59:169–72.
- [191] Froehlich P. A Sustainable Approach to the Supply of Nitrogen. Parker Hannifin Corporation 2013.
- [192] Launch of on-site nitrogen and oxygen generators. *Filtr Sep* 2017;54:12. doi:10.1016/s0015-1882(17)30021-6.
- [193] Brückner S, Liu S, Miró L, Radspieler M, Cabeza LF, Lävemann E. Industrial waste heat recovery technologies: An economic analysis of heat transformation technologies. *Appl Energy* 2015;151:157–67. doi:10.1016/j.apenergy.2015.01.147.
- [194] Kreith F, Manglik RM, Bohn MS. *Principles of Heat Transfer*. 7th ed. Stamford: Cengage Learning, Inc; 2011.
- [195] Shah RK, Sekulić DP. *Fundamentals of heat exchanger design*. vol. 4. John Wiley & Sons, Inc; 2003.
- [196] The National Productivity Council of India. United Nations Environment Programme, Waste Heat Recovery 2006.
- [197] Thekdi A, Nimbalkar SU. *Industrial Waste Heat Recovery - Potential Applications, Available Technologies and Crosscutting R&D Opportunities*. 2014. doi:10.2172/1185778.
- [198] Ilgaz Y. Thermal Energy Equipment: Waste Heat Recovery. *Energy Effic Guid Ind Asia* 2006;1–18.
- [199] Jasper GmbH. EcoReg, Rotary bed regenerator n.d. <https://www.jasper-gmbh.de/ecoreg-2434> (accessed December 2, 2019).
- [200] Henning B, Jasper R. Multimelter - The new generation of aluminium melting furnaces. *Heat Process* 2004.
- [201] Toolan S. *Heat Recovery for Commercial Buildings*, Dublin Institute of Technology 2012.

- [202] Indian Institute of Technology. Chapter 4, Waste Heat Recovery Through Heat Exchangers. Guwahati: 2017.
- [203] The Renewable Energy Hub UK. Types of Heat Recovery System n.d. <https://www.renewableenergyhub.co.uk/main/heat-recovery-systems-information/types-of-heat-recovery-system/> (accessed August 12, 2019).
- [204] Li Q, Flamant G, Yuan X, Neveu P, Luo L. Compact heat exchangers: A review and future applications for a new generation of high temperature solar receivers. *Renew Sustain Energy Rev* 2011;15:4855–75. doi:10.1016/j.rser.2011.07.066.
- [205] Bouhabila EH, Næss E, Einejord VK, Kristjansson K. An Innovative Compact Heat Exchanger Solution for Aluminum Off-Gas Cooling and Heat Recovery. In: Sadler BA, editor. *Light Met.* 2013, Cham: Springer International Publishing; 2016, p. 793–7. doi:10.1007/978-3-319-65136-1_135.
- [206] Spirax Sarco. An Explanation of Specialist Boiler Types and Other Specialist Features 2011.
- [207] Narendra Babu N, Kamath H c. Materials used in Heat Pipe. *Mater Today Proc* 2015;2:1469–78. doi:10.1016/J.MATPR.2015.07.072.
- [208] Faghri A. Heat Pipes: Review, Opportunities and Challenges. *Front Heat Pipes* 2014;5. doi:10.5098/fhp.5.1.
- [209] Jouhara H. 4.3 Heat Pipes. *Compr Energy Syst* 2018;4:70–97. doi:10.1016/b978-0-12-809597-3.00403-x.
- [210] Jouhara H, Chauhan A, Nannou T, Almahmoud S, Delpech B, Wrobel LC. Heat pipe based systems - Advances and applications. *Energy* 2017;128:729–54. doi:10.1016/j.energy.2017.04.028.
- [211] Vasiliev LL. Heat pipes in modern heat exchangers. *Appl Therm Eng* 2005;25:1–19. doi:10.1016/J.APPLTHERMALENG.2003.12.004.
- [212] Transterm. Overview of Heat Pipe Basics n.d. <http://www.transterm.ro/Overview.htm> (accessed August 13, 2019).
- [213] Econotherm Limited n.d. <https://www.econotherm.eu> (accessed August 20, 2019).
- [214] Celsia. Heat Pipe & Vapor Chamber Technology Overview n.d. <https://celsiainc.com/heat-pipe-and-vapor-chamber-technology-overview/> (accessed May 3, 2019).
- [215] Delpech B, Axcell B, Jouhara H. Experimental investigation of a radiative heat pipe for waste heat recovery in a ceramics kiln. *Energy* 2018;170:636–51. doi:10.1016/j.energy.2018.12.133.
- [216] Srimuang W, Amatachaya P. A review of the applications of heat pipe heat exchangers for heat recovery. *Renew Sustain Energy Rev* 2012;16:4303–15. doi:10.1016/j.rser.2012.03.030.
- [217] Chua KJ, Chou SK, Yang WM. Advances in heat pump systems: A review. *Appl Energy* 2010;87:3611–24. doi:10.1016/j.apenergy.2010.06.014.
- [218] Industrial Heat Pumps. Industrial Heat Pumps, How it works n.d. http://industrialheatpumps.nl/en/how_it_works/ (accessed August 23, 2019).
- [219] Incropera FP, Prescott PJ, Voelkel DD. Hybrid systems for furnace waste heat recovery: I. Use of a radiation recuperator with a Rankine cycle. *J Heat Recover Syst* 1985;5:321–30. doi:10.1016/0198-7593(85)90006-2.
- [220] Cotter WD. A Guide to Heat Exchangers for Industrial Heat Recovery. New York State Energy Res Dev Auth 1984.
- [221] Beltrán RAP. Study of Radiative Recuperators in High Temperature Furnaces 2017:112.
- [222] Ray H, Singh B, Bhattacharjee S, Misra VN. Energy in Minerals and Metallurgical Industries. 1st ed. Delhi: Allied Publishers Limited; 2005.

- [223] Patel SK, Patel AR. Review Paper on Investigation of Performance for Shell and Tube Heat Exchanger. *Int J Adv Eng Res Dev* 2015;2:552–6.
- [224] PT. Surya Besindo Sakti. Shell and Tube Heat Exchanger n.d. <https://www.sbs.co.id/index.php/products/shell-and-tube-heat-exchanger> (accessed August 13, 2019).
- [225] Sun X. An Overview on Piezoelectric Power Generation System for Electricity Generation. *J Power Energy Eng* 2017;05:11–8. doi:10.4236/jpee.2017.52002.
- [226] Yazawa K, Shakouri A. Thermal optimization of embedded thermoelectric generators in refractory furnaces. 15th IEEE ITherm Conf., 2016, p. 1489–93.
- [227] In BD, Lee KH. A study of a thermoelectric generator applied to a diesel engine. *Proc Inst Mech Eng Part D J Automob Eng* 2016;230:133–43. doi:10.1177/0954407015576440.
- [228] Yarygin VI, Klepikov VV, Meleta YA, Mikheyev AS, Yarygin DV, Wolff LR. Combustion heated cold seal TEC [thermionic energy convertor]. *Proc. IECEC*, 1997, p. 2264–70.
- [229] Khalid KAA, Leong TJ, Mohamed K. Review on Thermionic Energy Converters. *IEEE Trans Electron Devices* 2016;63:2231–41. doi:10.1109/TED.2016.2556751.
- [230] Viswanathan V, Davies R, Holbery J. Opportunity Analysis for Recovering Energy from Industrial Waste Heat and Emissions. US Dep Energy, Washingt 2006.
- [231] Spirax Sarco. Steam Jet Thermocompressor n.d. <https://beta.spiraxsarco.com/global/en-US/products/heat-transfer-solutions/thermocompressors> (accessed September 16, 2019).
- [232] Karamarković V, Marašević M, Karamarković R, Karamarković M. Recuperator for waste heat recovery from rotary kilns. *Appl Therm Eng* 2013;54:470–80. doi:10.1016/J.APPLTHERMALENG.2013.02.027.
- [233] Costa DS, Whipple DF. The use of regenerative burners systems to improve aluminium melting efficiencies. *Alum Two Thousand 5th World Congr Alum* 2003;Interall P.
- [234] Voyer R, Caron F. Energy efficiency of casthouse furnaces. *Light Met* 2010 n.d.:651–5.
- [235] Tipton Corp. Regenerative Burner Mechanism n.d. <http://www.tipton.co.jp/english/sc/sc02.html> (accessed August 12, 2019).
- [236] Chen Q, Swithenbank J, Sharifi VN. Review of Industrial Condensing Boilers (Technology & Cost). 2010.
- [237] Simeoni P, Ciotti G, Cottes M, Meneghetti A. Integrating industrial waste heat recovery into sustainable smart energy systems. *Energy* 2019;175:941–51. doi:10.1016/J.ENERGY.2019.03.104.
- [238] Arink T, Hassan MI. Metal Scrap Preheating using Flue Gas Waste Heat. *Energy Procedia* 2017;105:4788–95. doi:10.1016/J.EGYPRO.2017.03.945.
- [239] Dell’Oste EF. Procedure and means for preheating scrap to be charged into a smelting furnace. 4559629A US, 1985.
- [240] Selvaraj J, Harikesavan V. Solar thermal preheating of metallic scraps in foundries. *Int J Appl Eng Res* 2015;10:16693–708.
- [241] U.S. Department of Energy. Energy Tips - Process Heating. *Combust Technol Man* 2007.
- [242] Johansen I, Strømhaug SI. Energy control in primary aluminium casthouse furnaces. In: Sadler BA, editor. *Light Met*. 2013, Cham: Springer International Publishing; 2016, p. 935–9. doi:10.1007/978-3-319-65136-1_159.
- [243] Migchielsen JM, De Groot JD. Design Consideration for Charge Preheating Ovens. *Miner Met Mater Soc Annu Meetign Ans Exhib* 2006:737–40.

- [244] Evans R, Guest G. *The Aluminium Decoating Handbook* 2002.
- [245] Sung T, Yun E, Kim HD, Yoon SY, Choi BS, Kim K, et al. Performance characteristics of a 200-kW organic Rankine cycle system in a steel processing plant. *Appl Energy* 2016;183:623–35. doi:10.1016/J.APENERGY.2016.09.018.
- [246] Júnior EPB, Arrieta MDP, Arrieta FRP, Silva CHF. Assessment of a Kalina cycle for waste heat recovery in the cement industry. *Appl Therm Eng* 2019;147:421–37. doi:10.1016/J.APPLTHERMALENG.2018.10.088.
- [247] Børset MT, Wilhelmsen Ø, Kjelstrup S, Burheim OS. Exploring the potential for waste heat recovery during metal casting with thermoelectric generators: On-site experiments and mathematical modeling. *Energy* 2017;118:865–75. doi:10.1016/J.ENERGY.2016.10.109.
- [248] Precott PJ, Incropera FP. Hybrid systems for furnace waste heat recovery: II. Use of a convective recuperator with a Rankine cycle. *J Heat Recover Syst* 1985;5:331–9.
- [249] Caglayan H, Caliskan H. Energy, exergy and sustainability assessments of a cogeneration system for ceramic industry. *Appl Therm Eng* 2018;136:504–15. doi:10.1016/J.APPLTHERMALENG.2018.02.064.
- [250] Montorsi L, Milani M, Stefani M, Terzi S. Numerical analysis of the exhaust gases recovery from a turbine CHP unit to improve the energy efficiency of a ceramic kiln. *Therm Sci Eng Prog* 2018;5:444–53. doi:10.1016/J.TSEP.2018.01.013.
- [251] Peris B, Navarro-Esbrí J, Molés F, Mota-Babiloni A. Experimental study of an ORC (organic Rankine cycle) for low grade waste heat recovery in a ceramic industry. *Energy* 2015;85:534–42. doi:10.1016/J.ENERGY.2015.03.065.
- [252] Nikolaisen M, Andresen T. Optimization of System Operation and Heat Exchanger Sizing in Rankine Cycles: A Case Study On Aluminium Smelter Heat-to-Power Conversion. *Int. Semin. ORC Power Syst.*, 2019, p. 8.
- [253] Castelli AF, Elsidio C, Scaccabarozzi R, Nord LO, Martelli E. Optimization of organic rankine cycles for waste heat recovery from aluminum production plants. *Front Energy Res* 2019;7. doi:10.3389/fenrg.2019.00044.