

**Title:**

Analytical friction model for sliding bodies with coupled longitudinal and transverse vibration

**Authors:**

Priyang Udaykant Jadav<sup>a,c</sup> (*Corresponding author*)

[Priyang.Jadav@rotork.com](mailto:Priyang.Jadav@rotork.com)

Ramin Amali<sup>a</sup>

[Ramin2.Amali@uwe.ac.uk](mailto:Ramin2.Amali@uwe.ac.uk)

Oluwamayokun Adetoro<sup>b</sup>

[Mayo.Adetoro@brunel.ac.uk](mailto:Mayo.Adetoro@brunel.ac.uk)

<sup>a</sup> Department of Engineering Design and Mathematics, University of the West of England, Bristol, BS16 1QY, United Kingdom

<sup>b</sup> Department of Mechanical and Aerospace Engineering, Brunel University London, Uxbridge, UB8 3PH, United Kingdom

<sup>c</sup> Rotork Controls Ltd, Bath, BA1 3JQ, United Kingdom

**ABSTRACT**

An analytical friction model is developed to calculate the drive force required to slide a body over a surface that is subjected to coupled longitudinal and transverse vibration. Previously, this computation was only possible under either longitudinal or transverse vibration using a separate analytical model for each mode. This paper presents a development of recent research in which it is possible to use a single analytical model, developed in Matlab®/Simulink®, to compute the friction force and drive force during longitudinal, transverse and coupled longitudinal-transverse vibration. The new model is also evaluated numerically by use of a specially developed friction subroutine which can be integrated into any Abaqus® dry contact simulation. Results agree very well with those in previously published literature.

Keywords: Friction, Vibration, Modelling, Analytical

---

**1. Introduction**

In mechanical systems that involve predominantly dry sliding contacts the efficiency of the system can be significantly improved by reducing the friction force between the rubbing surfaces. This is usually achieved by improving the surface quality of the contacting pair, utilising conventional lubricants [1-3] or those enhanced with nano-particles [4-6], or by applying surface coatings [7,8]. A less typical method of friction reduction and one that has been the subject of theoretical analyses for several decades is the phenomenon of reduced friction force of surfaces when subjected to vibration. Frictional forces may cause undesired vibrations in a system as a result of stick-slip motion at the contact, conversely, many studies [9-25] have shown that imposed vibration can significantly reduce the friction force between two contacting surfaces. In such studies the vibration is applied to the contact by exciting one of the contacting bodies in the normal, longitudinal or transverse direction.

Considerable research has been devoted to exploiting this phenomenon in various manufacturing processes. Jimma et al. [26] found that vibration applied to the deep drawing process enables deeper cups to be formed whilst avoiding cracks in steel drawn parts, Siegert and Ulmer [27] showed that it is possible to further reduce the friction force by having the drawing dies vibrate parallel to the drawing direction at frequencies ranging 20-22 kHz. Egashira et al. [28] utilised vibration whilst drilling micro holes in glass to reduce the cutting force and extend tool life. In the food industry, vibrating blades are used to reduce friction when cutting through foods [29]. Screws can also be tightened with considerably less torque through an instantaneous reduction in the friction force supplied by vibration.

The first work investigating the influence of vibration on friction dates back to a 1952 study by Baker et al. [9] in which they determined that the coefficient of static friction under the influence of imposed normal vibration can be minimised to almost zero. Experiments by Fridman and Levesque [10] and also by Godfrey [11] showed that pulling a block of mass over a plate vibrating perpendicular to the contact, with increasing vibration amplitude, reduces the static friction coefficient by almost 100%. One of the first attempts to explain friction force reduction due to normal vibration was made by Lenkiewicz [12]; vibrations forced perpendicularly or at an angle to the friction surface generally cause changes in the value of the real contact area, and consequently changes in the value of the friction force. This is in agreement with Hess and Soom [13] who concluded that a temporary debonding of the contact surfaces leads to a reduction in the mean area of contact and a corresponding reduction in friction. In this century, normal vibration applied in custom built pin-on-disk tribometers have shown a decrease in friction coefficient with increasing vibration frequency and amplitude, between both metallic [14] and non-metallic surfaces [15].

In the case of longitudinal vibration conjecture, until recently, has been that the reduction of average friction force occurs as a result of cyclic instantaneous changes in the direction of the friction force vector, caused by changes in the sign of relative velocity when the amplitude of vibration velocity is greater than the velocity of sliding motion [16-22]. Gutowski and Leus [23] have shown that this commonly accepted view is erroneous. Reduction of average friction force may also take place without the change in sign of the friction force vector. One of the reasons behind the antiquated

view is that in friction force estimations, the simplified static friction models based on the Coulomb model of friction are assumed. In these models the deformation in the contact zone of two surfaces moving in relation to one another is not taken into consideration. This creates significant difficulties in the conduct of simulational analyses due to their insufficient consistency with experimental results. Gutowski and Leus [23] have shown that significantly better results can be achieved by conducting the analyses using dynamic friction models, such as the Dahl or Dupont model in which the real elasto-plastic characteristics of the contact are considered. Analyses carried out with the use of Dahl friction model yield very good agreement between computations and experimental results.

During transverse vibration a variable vector of relative velocity of sliding causes oscillations of the friction force vector around the sliding direction, resulting in a sub-division of this force into two components, one parallel ( $F_x$ ) and one perpendicular ( $F_y$ ) to the direction of motion, see Fig. 3c. Consequently, only the parallel component of friction force acts in the direction of motion, resulting in the reduction of driving force  $F_d$  required in this direction. Investigations [18-22] based on this mechanism have also shown a large discrepancy between analytical and experimental results since the analytical models are based on the Coulomb friction model. Gutowski and Leus [24] again demonstrated that a much better agreement can be achieved by utilising an analytical model which considers dynamic friction together with dynamic equations of motion, whilst also including terms to describe the compliance of the mechanical drive system.

This paper focuses on the latter two modes of vibration that are tangential to the plane of contact. Tsai and Tseng [25] assumed that tangential vibrations are imposed directly onto the sliding body and analysed the effect on friction force reduction. They used the Dahl friction model [30,31] on a single lumped elastic asperity to investigate the reduction phenomenon. Gutowski and Leus [23,24] on the other hand, applied vibration to the base and assumed that this vibration is transferred to the sliding body. They developed an analytical model for longitudinal vibration and a separate model for transverse vibration, however, a model for coupled longitudinal-transverse vibration does not exist in literature. This paper proposes a new model, based on the approach of Gutowski and Leus [23,24], to describe the changes in friction force and drive force for sliding surfaces subjected to coupled vibration. The previous models [23,24] are used as basis for validating the new model.

There are four objectives of the work presented in this paper; (i) derivation of a mathematical model that can be used to determine quantitative changes in the friction force occurring at the contact between the sliding body and the base which is under the influence of longitudinal, transverse or coupled vibration (ii) simulation of the new model both analytically in Matlab®/Simulink® and numerically in Abaqus® (iii) validation of the new model by comparison of results with analogous ones in previous publications (iv) analysis of how the drive force  $F_d$  is influenced by different modes of imposed coupled vibration.

## 2. Model formulation

Dahl [30] discovered that when an external drive force is applied on a static body that is in contact with another, an intermediate motion of one surface over the other occurs before the bodies enter macroscopic relative motion. This intermediate motion is often described as pre-sliding displacement, otherwise termed “elastic slip”, and is the result of real surfaces having asperities that interlock when two surfaces are in contact. The application of external drive force on the body initially creates an elastic deformation of the contacting asperities. As the asperities undergo increased strain, yielding occurs and the two surfaces then start to break free of each other. During this time plastic deformation of asperities takes place. Finally, asperity rupture occurs leading to formation of further surface irregularities which will continuously undergo strain and rupture as sliding takes place [30]. Thus, in Dahl’s dynamic friction model it is assumed that the friction force  $F$  is associated with the elastic deformation  $s$  of the contact (Fig. 1) measured in the direction of sliding:

$$F = k_t s \quad (1)$$

where  $k_t$  is the stiffness of the contact in the tangential direction. This is illustrated in Fig. 1 where the deformable contacting asperities of the sliding body and the base are thought of as a single lumped asperity  $MN$ .

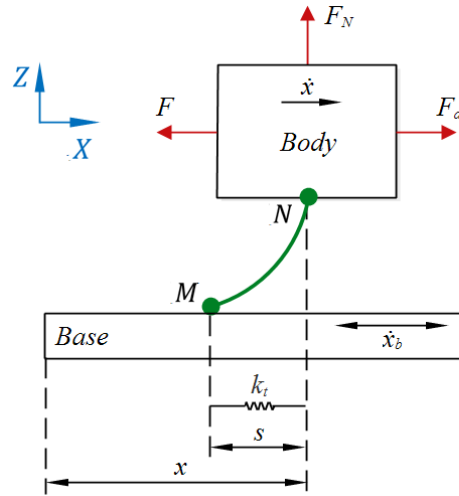

Fig. 1. Elastic strain 's' of contact zone assumed in Dahl's friction model

The force-displacement relationship is modelled by Dahl [31] with the following differential equation:

$$\frac{dF}{dx} = \begin{cases} k_t \left[ 1 - \frac{F}{F_C} \text{sgn}(\dot{x}) \right]^i & \text{if } i > 0 \\ k_t & \text{if } i = 0 \end{cases} \quad (2)$$

where  $dF$  and  $dx$  are the incremental friction force and incremental displacement respectively, and  $\dot{x}$  is the instantaneous velocity of the body in the direction of sliding.  $F_C$  is the magnitude of Coulomb friction force, given by:

$$F_C = \mu F_N \quad (3)$$

where  $\mu$  is the coefficient of static friction and  $F_N$  is the normal reaction force.

The parameter  $i$  in equation (2) determines the shape of the relationship between the tangential displacement  $x$  and friction force  $F$ .  $i = 0$  describes brittle material behaviour, where the friction force linearly increases with tangential displacement at a gradient  $k_t$  (Fig. 2), until the maximum friction force is reached and the surfaces break away. This maximum force is equal to the Coulomb friction force  $F_C$ . As the value of  $i \rightarrow 2$  the material behaviour becomes ductile producing a non-linear response of  $F$  which is asymptotic to the value of  $F_C$  [31]. The value  $i = 1$  is used for all computations in this paper.

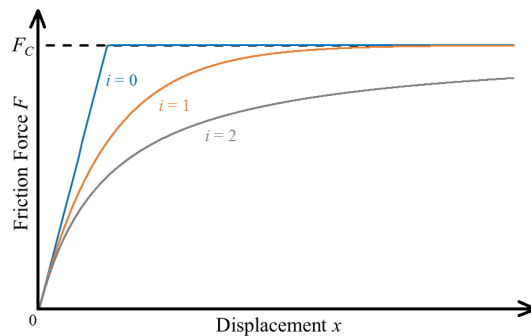

Fig. 2. The effect of parameter  $i$  on the relationship between friction force  $F$  and displacement  $x$

By substituting (1) and (3) into (2), the relationship can be written in the form of (4), which describes the relationship between the velocity of contact deformation  $ds/dt$  and the velocity  $\dot{x}$  of the sliding body.

$$\frac{ds}{dt} = \dot{x} \left[ 1 - \frac{k_t s}{\mu F_N} \text{sgn}(\dot{x}) \right]^i \quad (4)$$

The instantaneous velocity  $\dot{x}$  can be thought of as the relative velocity  $v_r$  of the sliding body in relation to the base velocity  $\dot{x}_b$  (Fig. 1), where:

$$v_r = \dot{x} - \dot{x}_b = \begin{cases} \dot{x} & \text{if } \dot{x}_b = 0, \text{ i. e. stationary base} \\ v_r & \text{if } \dot{x}_b \neq 0, \text{ i. e. vibrating base} \end{cases} \quad (5)$$

Therefore (4) can be written in a generalised form which takes into account both the non-vibrating and vibrating cases:

$$\frac{ds}{dt} = v_r \left[ 1 - \frac{k_t s}{\mu F_N} \text{sgn}(v_r) \right]^i \quad (6)$$

Fig. 1 depicts the case of longitudinal vibration which is a one-dimensional problem; the vibration of the base acts parallel to the direction of sliding of the body therefore deformation  $s$  of elastic asperity  $MN$  occurs in one dimension. Equation (6) can be readily used in this case.

In transverse, or coupled longitudinal-transverse vibration, the problem becomes two dimensional since the deformation  $s$  no longer occurs parallel to the direction of sliding. Equation (6) therefore cannot be readily used in these cases. Gutowski and Leus [24] developed a mathematical model for computing friction force during transverse vibration. In the following work it is shown that the transverse vibration model can be extended for use with longitudinal and coupled longitudinal-transverse vibration.

Mathematical computational procedures were developed assuming the Dahl model in combination with the experimental setup described by Gutowski and Leus [23,24]. Their specially designed test rig comprises a body of known mass  $m$  moved over a base that can be vibrated by a piezoelectric element either in the longitudinal or transverse mode. Fig. 3a is a schematic representation of their setup with the assumption, for the purposes of this paper, that vibration can be applied not only in longitudinal ( $X$ ) or transverse ( $Y$ ) mode but can also be coupled so that longitudinal and transverse components act simultaneously and in phase. Mathematically this is equivalent to applying the vibration along an axis that is at an arbitrary angle  $\theta$  (Fig. 3b) relative to the direction of sliding. Angle  $\theta$  thus describes the mode of vibration. The displacement of the base during this coupled vibration can be separated into longitudinal and transverse components  $x_b$  and  $y_b$  respectively.

The movement of mass  $m$  over the base is imposed by a constant drive velocity  $v_d$  applied at point  $B$  (Fig. 3a), while sinusoidal vibration applied to the base is also transferred to the body, corresponding to an instantaneous external drive force  $F_d$ . The drive force is transferred to point  $A$  of the sliding body via the drive system of which the stiffness coefficient  $k_d$  is known and zero structural damping is assumed, hence  $h_d = 0$ . Endpoint  $N$  of the lumped asperity is attached to the sliding body, while the free endpoint  $M$  interfaces with the vibrating base.  $N'$  is the projection of  $N$  on the plane of sliding  $XY$ . Relative displacement of points  $M$  and  $N'$  creates the deformation  $s$  of the contact at an angle  $\beta$  measured in the  $XY$  plane.

In transverse vibration [24] the motion of the body sliding over the vibrating base is a superposition of two motions; the first caused by the driving force  $F_d$ , and the second by the transfer of transverse motion  $y_b$  from the base to the sliding body. When coupling longitudinal vibration to the transverse, a third motion must also be superimposed; the motion of the sliding body caused by the transfer of longitudinal motion  $x_b$  from the base. All three of these motions influence the magnitude

and direction of elastic deformation  $s$  of the contact zone. This deformation directly decides the magnitude and direction of the friction force  $F$ .

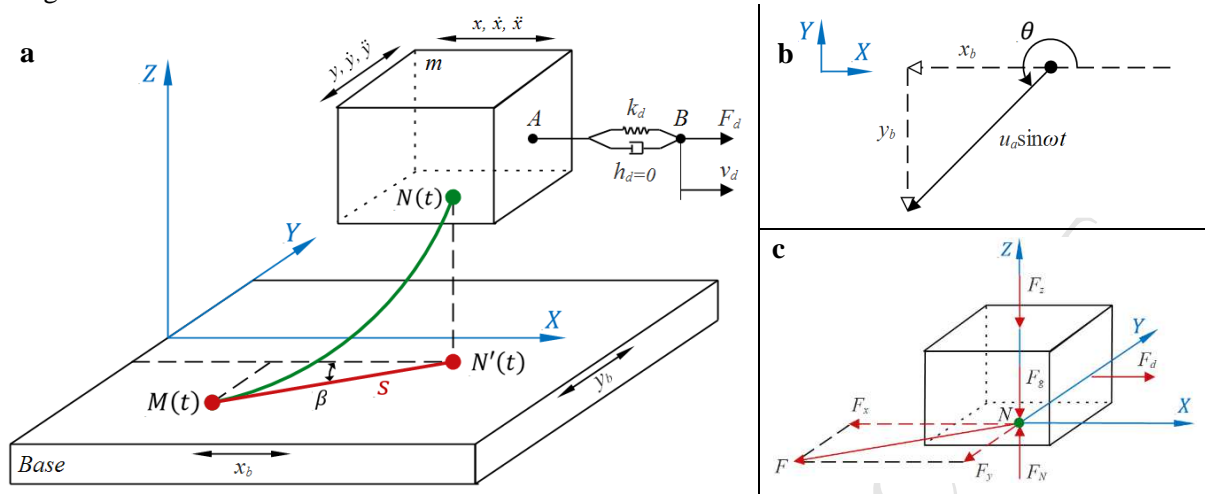

Fig. 3. (a) Contact's elastic deformation modelled as a lumped elastic asperity  $MN$  [24] (b) instantaneous displacement vector of base vibrating along an axis at angle  $\theta$ , separated into components  $x_b$  and  $y_b$  (c) instantaneous forces acting on sliding body [24]

The new model is a development of previous models [23,24] and follows the formulation described by the sequence of equations henceforth using notations presented in Fig. 4. Boxed notations indicate state variables; their value calculated in the previous increment is carried forward for use in the current increment. During a consecutive time increment  $\Delta t$ , points  $M$  and  $N'$  change their relative positions thus elastic deformation of the contact undergoes a change in its magnitude and direction from  $s(t)$  at the beginning of the increment to  $s_1(t + \Delta t)$  at the end of the increment. Coordinates of  $M$  and  $N'$ , and magnitude of  $s(t)$  at the start of the increment are given by:

$$M(t) = [M_x(t), M_y(t)] = [\boxed{M_{1x}}, \boxed{M_{1y}}] \quad (7)$$

$$N'(t) = [N'_x(t), N'_y(t)] = [\boxed{N'_{1x}}, \boxed{N'_{1y}}] = [\boxed{x}, \boxed{y}] \quad (8)$$

$$s(t) = \boxed{s_1} \quad (9)$$

and at the end of the increment by:

$$M(t + \Delta t) = M_1 = [M_{1x}, M_{1y}] \quad (10)$$

$$N'(t + \Delta t) = N'_1 = [N'_{1x}, N'_{1y}] = [x, y] \quad (11)$$

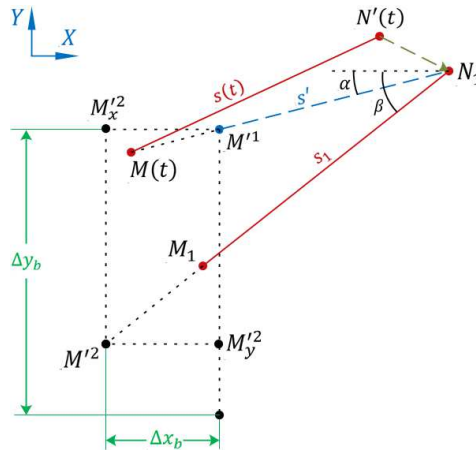

Fig. 4. Change in magnitude and direction of deformation from  $s$  to  $s_1$  over a single time increment  $\Delta t$

The position of points  $M$  and  $N'$  at any instance is a result of superposition of the motion caused by the driving force  $F_d$ , the base longitudinal vibration component  $x_b$  and transverse component  $y_b$ . At consecutive instances  $M$  and  $N'$  change their relative position, thus elastic deformation of the contact undergoes a change in its magnitude and direction from  $s$  to  $s_1$ . This change during any consecutive time increment  $\Delta t$  is separated into two phases. In the first phase the intermediate deformation  $s'$  is analysed as a result of motion of point  $N'$  to  $N'_1$  position. In the second phase the final deformation  $s_1$  is analysed as a result of motion of point  $M'^1$  to  $M'^2$  position. The displacement from  $M'^1$  to  $M'^2$  is described by components  $\overline{M'^1M'^2_x}$  and  $\overline{M'^1M'^2_y}$ . Since  $N$  is rigidly connected with the sliding body, its coordinates  $[x, y]$  in the  $XY$  plane can be described by equations (14) and (16).

$$m\ddot{x} = F_d - F_x \quad (12)$$

$$\Delta x = \iint \frac{F_d - F_x}{m} dt dt - \boxed{\iint \frac{F_d - F_x}{m} dt dt} \quad (13)$$

$$x = \Delta x - \boxed{\Delta x_b} + \boxed{x} \quad (14)$$

where  $F_d$ ,  $F_x$  and  $\Delta x_b$  are calculated by equations (17), (38) and (28) respectively.

$$m\ddot{y} = F_y \quad (15)$$

$$y = \iint \frac{F_y}{m} dt dt \quad (16)$$

where  $F_y$  is calculated by equation (39).  $F_x$  and  $F_y$  are components of the friction force  $F$  acting parallel to the  $X$  and  $Y$  axes respectively (Fig. 3c). Point  $B$  moves at a constant drive velocity  $v_d$  whereas the velocity of point  $A$ , being rigidly connected to the sliding body, is affected by the transfer of vibrating motion from the base to the body. Due to a continually changing position of point  $A$  relative to  $B$ , the driving force  $F_d$  does not have a constant value. It is a function of the variable elastic deformation of the mechanical drive's components. Assuming the drive system has a linear elastic characteristic, the drive force is calculated by:

$$\begin{aligned} F_d &= k_d[x_B - x_A] \\ &= k_d[v_d t - N'_{1x}] \end{aligned} \quad (17)$$

where  $t$  is time, and  $N'_{1x} = x$  is the instantaneous displacement of the sliding body in the  $X$  direction, determined by equation (14).

## 2.1. First phase of motion

During a consecutive time interval  $\Delta t$ , in the first phase of motion, displacement of the sliding body occurs which moves  $N'$  to the  $N'_1$  position (Fig. 4). At the same instance,  $M$  moves along the path  $\overline{MN'_1}$  to the  $M'^1$  position. Consequently, deformation  $s$  changes to an intermediate  $s'$  with a new magnitude and direction. Instantaneous direction of this deformation is determined by angle  $\alpha$ , whilst the change in its magnitude by an increment  $\Delta s$  [24]. The increment  $\Delta s$  can be evaluated using relationship (6), therefore, the magnitude of deformation  $s'$  after this first phase of motion is calculated by:

$$\begin{aligned} s' &= s + \Delta s \\ &= \boxed{s_1} + v_{r1} \left[ 1 - \frac{k_t \boxed{s_1}}{\mu F_N} \text{sgn}(v_{r1}) \right]^i \Delta t \end{aligned} \quad (18)$$

Relative velocity  $v_{r1}$  along the line of action of the lumped elastic asperity can be determined from the following expression:

$$v_{r1} = \frac{\overline{MN}'_1 - \overline{MN}'}{\Delta t} = \frac{\overline{MN}'_1 - s}{\Delta t} = \frac{\overline{MN}'_1 - [S_1]}{\Delta t} \quad (19)$$

where

$$\begin{aligned} \overline{MN}'_1 &= \sqrt{[N'_{1x} - M_x(t)]^2 + [M_y(t) - N'_{1y}]^2} \\ &= \sqrt{[x - [M_{1x}]]^2 + [[M_{1y}] - y]^2} \end{aligned} \quad (20)$$

Direction of  $v_{r1}$  in relation to axis  $X$  is determined by angle  $\alpha$  (Fig. 4) where:

$$\sin \alpha = \begin{cases} \frac{[M_{1y}] - y}{\overline{MN}'_1} & \text{if } t > t_v \\ 0 & \text{if } t \leq t_v \end{cases} \quad (21)$$

$$\cos \alpha = \begin{cases} \frac{x - [M_{1x}]}{\overline{MN}'_1} & \text{if } t > t_v \\ 1 & \text{if } t \leq t_v \end{cases} \quad (22)$$

and  $t_v$  is the time at which vibration is switched on. The *if* conditions in (21) and (22) are necessary to avoid nan errors in the formulation when  $\overline{MN}'_1 = 0$ .

## 2.2. Second phase of motion

Within the same time increment  $\Delta t$ , in the second phase of motion, in accordance with Fig. 3b, the base undergoes coupled longitudinal-transverse vibration such that the longitudinal component  $x_b$  and transverse component  $y_b$  act simultaneously and in phase. Mathematically this coupled motion can be treated as vibration applied along an axis that is at an arbitrary angle  $\theta$ . The instantaneous displacement  $u$  of this sinusoidal vibrating motion along the axis of vibration is given by:

$$u = \begin{cases} u_a \sin \omega t & \text{if } t \geq t_v \\ 0 & \text{if } t < t_v \end{cases} \quad (23)$$

where  $u_a$  is the amplitude of the displacement of vibration and  $\omega$  is the angular frequency in rad/s. The above equation acts as a switch that activates the sinusoidal vibration at  $t \geq t_v$ . The displacement components  $x_b$  and  $y_b$  in Fig. 3b are thus given by:

$$x_b = u \cos \theta \quad (24)$$

$$y_b = u \sin \theta \quad (25)$$

and the instantaneous velocity  $v$  of this sinusoidal motion along the axis of vibration is given by:

$$v = \begin{cases} u_a \omega \cos \omega t & \text{if } t \geq t_v \\ 0 & \text{if } t < t_v \end{cases} \quad (26)$$

where  $u_a \omega$  is the amplitude of the velocity of vibration  $v_a$ , and hence:

$$v_a = u_a \omega = 2\pi f u_a \quad (27)$$



In longitudinal vibration, where  $\theta$  is  $0^\circ$  or  $180^\circ$ , only  $x_b$  changes direction and  $y_b$  remains zero. In transverse vibration, where  $\theta$  is  $90^\circ$  or  $270^\circ$ , only  $y_b$  changes direction and  $x_b$  remains zero. During any other mode of vibration, the vector direction of both  $x_b$  and  $y_b$  will change.

At the beginning of increment  $\Delta t$  the base touches the sliding body at point  $M$ . After the lapse of  $\Delta t$ , the base incremental displacements  $\Delta x_b$  and  $\Delta y_b$  (Fig. 4) are:

$$\Delta x_b = x_b - \overline{x_b} \quad (28)$$

$$\Delta y_b = y_b - \overline{y_b} \quad (29)$$

The effect of incremental displacement  $\Delta x_b$  is described by (14), whereas the effect of  $\Delta y_b$  by (30).  $\Delta y_b$  is only partially transferred to endpoint  $M$  [24], therefore, the displacement  $\overline{M'^1 M_y'^2}$  of point  $M'^1$  caused by the transverse component of vibrating motion comprises only a part of the incremental displacement  $\Delta y_b$  of the base:

$$\overline{M'^1 M_y'^2} = \eta_y \Delta y_b \quad (30)$$

where  $\eta_y$  is the transverse vibration transfer coefficient defining the proportion of  $\Delta y_b$  that is transferred to move the free endpoint from  $M'^1$  to the  $M'^2$  position. The consequence of this second phase of motion is a further change of asperity deformation from an intermediate  $s'$  to final magnitude  $s_1$  (Fig. 4). Instantaneous direction of this deformation is determined by angle  $\beta$ , whilst the change in its magnitude by an increment  $\Delta s'$  [24]. In similarity with the previous phase,  $\Delta s'$  can be evaluated using relationship (6), therefore, the final magnitude of deformation  $s_1$  after this second phase of motion is calculated by:

$$\begin{aligned} s_1 &= s' + \Delta s' \\ &= s' + v_{r2} \left[ 1 - \frac{k_t s'}{\mu F_N} \text{sgn}(v_{r2}) \right]^i \Delta t \end{aligned} \quad (31)$$

Relative velocity  $v_{r2}$  along the new line of action of the lumped elastic asperity can be determined from the following expression:

$$v_{r2} = \frac{\overline{N'_1 M'^2} - \overline{N'_1 M'^1}}{\Delta t} = \frac{\overline{N'_1 M'^2} - s'}{\Delta t} \quad (32)$$

where

$$\begin{aligned} \overline{N'_1 M'^2} &= \sqrt{[s' \cos \alpha]^2 + [s' \sin \alpha + \overline{M'^1 M_y'^2}]^2} \\ &= \sqrt{[s' \cos \alpha]^2 + [s' \sin \alpha + \eta_y \Delta y_b]^2} \end{aligned} \quad (33)$$

Direction of  $v_{r2}$  in relation to axis  $X$  is determined by angle  $\beta$  (Fig. 4) where:

$$\sin \beta = \begin{cases} \frac{s' \sin \alpha + \eta_y \Delta y_b}{\overline{N'_1 M'^2}} & \text{if } t > t_v \\ 0 & \text{if } t \leq t_v \end{cases} \quad (34)$$

$$\cos \beta = \begin{cases} \frac{s' \cos \alpha}{\overline{N'_1 M'^2}} & \text{if } t > t_v \\ 1 & \text{if } t \leq t_v \end{cases} \quad (35)$$

The *if* conditions in (34) and (35) are necessary to avoid nan errors in the formulation when  $\overline{N'_1 M'^2} = 0$ . At the end of increment  $\Delta t$ , knowing the magnitude of deformation  $s_1$  and its direction  $\beta$ , as well as coordinates  $[x, y]$  of point  $N'_1$ , it is possible to determine the coordinates of point  $M_1$  at which the endpoint  $M$  is placed after lapse of increment  $\Delta t$ :

$$\begin{aligned} M_{1x} &= N'_{1x} - s_1 \cos \beta \\ &= x - s_1 \cos \beta \end{aligned} \quad (36)$$

$$\begin{aligned} M_{1y} &= N'_{1y} + s_1 \sin \beta \\ &= y + s_1 \sin \beta \end{aligned} \quad (37)$$

In accordance with relationship (1) and notations per Fig. 3 and Fig. 4, an instantaneous value of friction force components  $F_x$  and  $F_y$  can also be determined:

$$F_x(t + \Delta t) = k_t s_1 \cos \beta \quad (38)$$

$$F_y(t + \Delta t) = k_t s_1 \sin \beta \quad (39)$$

### 2.3. Consecutive time increments

The values of state variables listed in Table 1 computed during increment  $\Delta t$  are carried forward to the next consecutive time increment  $\Delta t_2$ . The sequence of equations (7) to (37) is then repeated to determine the coordinates of point  $M_2$  at which the endpoint  $M$  is placed after lapse of time increment  $\Delta t_2$ . Equations (38) and (39) compute the components of friction force at the end of  $\Delta t_2$ . At consecutive increments ( $3\Delta t, 4\Delta t, \dots, n\Delta t$ ) the cycle described by these equations is repeated.

State variable	Computed during $\Delta t$ by	Carried forward to $\Delta t_2$ for use as
$\iint \frac{F_d - F_x}{m} dt dt$	(13)	$\iint \frac{F_d - F_x}{m} dt dt$ in (13)
$x$	(14)	$x$ in (8) and (14)
$y$	(16)	$y$ in (8)
$x_b$	(24)	$x_b$ in (28)
$y_b$	(25)	$y_b$ in (29)
$\Delta x_b$	(28)	$\Delta x_b$ in (14)
$s_1$	(31)	$s_1$ in (18) and (19)
$M_{1x}$	(36)	$M_{1x}$ in (7), (20) and (22)
$M_{1y}$	(37)	$M_{1y}$ in (7), (20) and (21)

Table 1: State variables

### 3. Methodology

The new model was evaluated by two methods; (i) in the Matlab®/Simulink® environment an analytical computation procedure was developed with equations (7) to (39) (ii) in Abaqus® the three-dimensional domain was numerically simulated by finite element method, with the model implemented via a specially developed friction subroutine defining the tangential contact behaviour between the body and base. The sliding body, Fig. 5, was a cuboid with contact area  $0.030 \text{ m} \times 0.040 \text{ m}$  and height  $0.053 \text{ m}$ , made up of deformable hexahedral elements. The base was a  $0.1 \text{ m} \times 0.1 \text{ m}$  analytical rigid shell. The material definition applied to deformable elements had Young's modulus  $209 \text{ GPa}$  and Poisson's ratio  $0.3$ . There are two body masses  $m$  used in this paper; the density was set to  $7850 \text{ kg/m}^3$  for a mass of  $0.5 \text{ kg}$ , or  $31400 \text{ kg/m}^3$  for mass  $2 \text{ kg}$ . A spring element with stiffness  $k_d$  was applied between points  $A$  and  $B$ . A normal pressure load in addition to gravitational load was

applied to attain a normal reaction force  $F_N$ . The base orientation can be set between  $0^\circ \leq \theta < 360^\circ$  in the  $XY$  plane, thereby applying any mode of in-plane vibration.

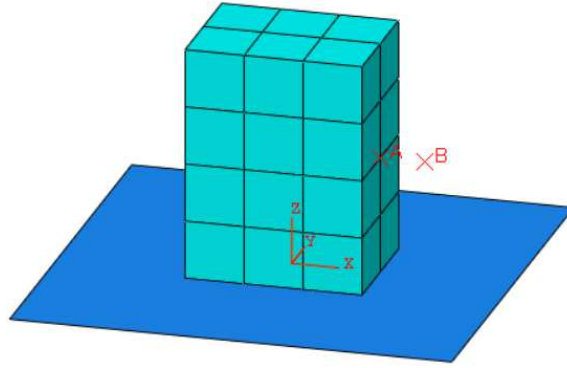

Fig. 5: 3D domain in Abaqus®

## 4. Results and discussion

In 4.1 and 4.2, results of longitudinal and transverse vibration are compared with analogous ones accepted in previous literature [23,24] that have shown a good match to experiments. Coupled longitudinal-transverse vibration is then evaluated in 4.3.

### 4.1. Longitudinal vibration

The longitudinal vibration model accepted in literature [23] was executed with the same parameters as utilised therein;  $v_d = 0.0005$  m/s,  $m = 0.5$  kg,  $f = 4000$  Hz,  $\mu = 0.1$ ,  $F_N = 55$  N,  $k_t = 80E6$  N/m. The value  $k_d = 96068$  N/m was estimated by extracting data from graphs [23] and substituting into relationship (17). The total simulation time was set to 1 sec and a fixed time step of  $1E-6$  sec was utilised with vibration of the base starting at 0.14 sec. Fig. 6 illustrates the computed variability of drive force  $F_{dv}$  under the influence of longitudinal vibration in relation to the magnitude  $F_{ds}$  of this force without vibration as a function of a dimensionless coefficient  $k_v = v_a/v_d$ . Each data point on the graph corresponds to the result of a single simulation. The data points collectively form a trend indicated by the dashed line.

The new coupled vibration model proposed in this paper was then executed in Matlab®/Simulink® and Abaqus® using the same parameters while varying the value of  $k_v$ . To reduce computation effort in Abaqus® a larger time step of  $1E-5$  sec was utilised. The vibration mode was set to longitudinal by setting  $\theta = 0^\circ$ . Since  $y_b$  given by (25) remains zero at  $\theta = 0^\circ$ ,  $\overline{M}^{-1}\overline{M}_y^2$  given by (30) also remains zero, therefore, the value of transverse vibration transfer coefficient  $\eta_y$  has no effect on the results of longitudinal vibration. Longitudinal vibration results obtained from the new model are also plotted in Fig. 6 and agree very well with the plotted trend. There is no reduction in drive force due to longitudinal vibration when  $k_v \leq 1$ .

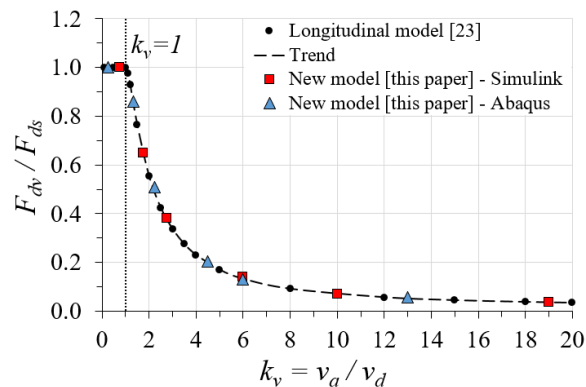

Fig. 6. Change in  $F_{dv}/F_{ds}$  as  $k_v$  increases in longitudinal vibration

Changes in drive force  $F_d$  and friction force  $F_x$  with time, computed using the new model when  $k_v = 6$  ( $v_a = 0.003$  m/s), are plotted in Fig. 7 and Fig. 8 in comparison to results obtained from the longitudinal vibration model [23]. Simulations begin with the body stationary, hence initially there is no elastic slip at the contact, resulting in  $F_d = 0$  N at  $t = 0$  sec (Fig. 7). Application of constant drive velocity  $v_d$  at  $t > 0$  sec causes elastic deformation  $s$  to increase, resulting in a steady rise in  $F_d$  until  $t \approx 0.12$  sec at which time breakaway occurs due to  $F_d$  reaching the magnitude of  $\mu F_N = 5.5$  N. Switching on vibration at  $t = 0.14$  sec significantly reduces the magnitude of  $F_d$  as the body continues to slide.

Also shown in Fig. 7, the new model when evaluated in Matlab®/Simulink® produces greater undulation of  $F_d$ . This is a characteristic of the new model and is due to the computation of  $x$ , equation (14), being different to how  $x$  is determined in the longitudinal model [23]. This undulation decreases as the vibration mode  $\theta$  approaches transverse at  $90^\circ$  and  $270^\circ$ , see Fig. 10.  $F_{dv}$  is thus determined by averaging its magnitude within a single cycle:

$$F_{dv} = \frac{1}{n} \sum_{i=1}^n F_{dvi}(t + \Delta t_i) \quad (40)$$

where  $n$  is the number of time intervals into which a single vibration cycle is divided:

$$n = \frac{1}{f\Delta t} \quad (41)$$

At  $k_v = 6$  friction force component  $F_x$  undergoes cyclic changes in magnitude and direction (Fig. 8), therefore, its average value over a single vibration cycle reduces from  $\mu F_N = 5.5$  N when there is no vibration to a lower value when vibration is initiated, hence the drive force is also reduced. Analytical results of the new model obtained via Matlab®/Simulink® show an exact match of  $F_x$  to the longitudinal model [23], however, numerical results from Abaqus® show subtle differences. These differences can be attributed to the Abaqus® solver which evaluates the model iteratively in each time increment to compute an approximation while enforcing equilibrium of internal structure forces with externally applied loads, whereas Matlab®/Simulink® performs an analytical calculation that outputs the exact solution to the formulation. These subtle differences in  $F_x$  affect the correlation of the Abaqus® computed drive force in Fig. 7, otherwise the new model agrees very well with previous work.

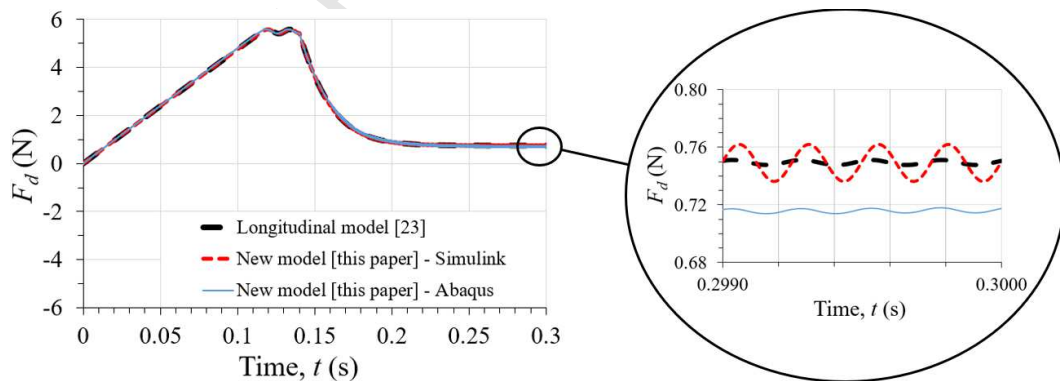

Fig. 7: Comparison of change in  $F_d$  when longitudinal vibration is switched on,  $k_v = 6$

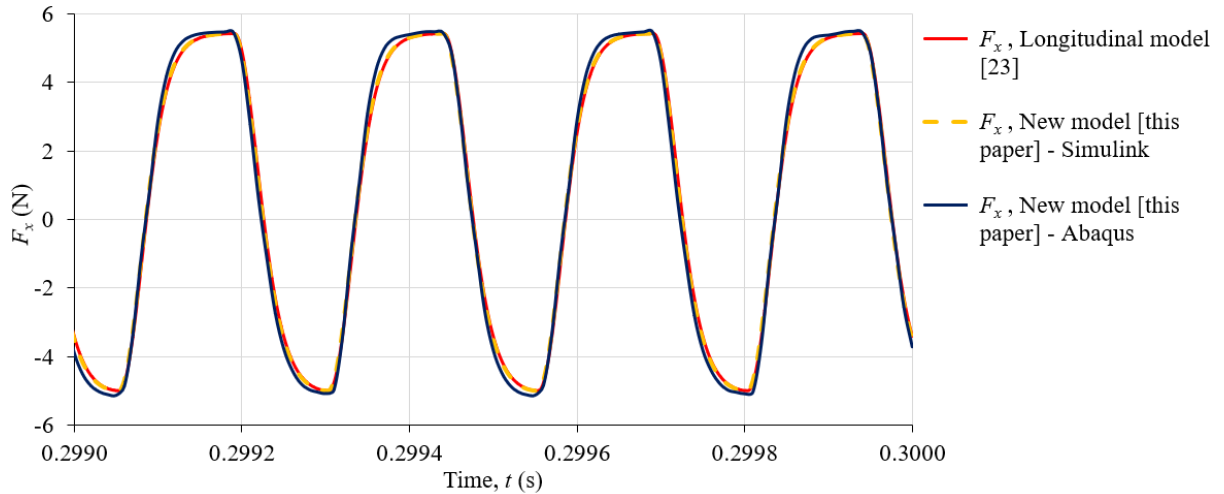

Fig. 8. Comparison of friction force changes during longitudinal vibration,  $k_v = 6$

## 4.2. Transverse vibration

The new coupled model was executed for transverse vibration with parameters matching those utilised in literature [24];  $v_d = 0.0005$  m/s,  $m = 2$  kg,  $f = 3000$  Hz,  $\mu = 0.1$ ,  $F_N = 50.8$  N,  $k_t = 67.29E6$  N/m,  $k_d = 96068$  N/m. The total simulation time was set to 0.5 sec and a fixed time step of  $1E-6$  sec in Matlab®/Simulink®, and  $1E-5$  sec in Abaqus®, was utilised with vibration of the base starting at 0.14 sec. The vibration mode was set to transverse by setting  $\theta = 270^\circ$ . The transverse vibration transfer coefficient was assumed  $\eta_y = 0.71$ . This is the value estimated by Gutowski and Leus [24] at which their transverse vibration model produces a good match to results of all experiments carried out at  $f = 3000$  Hz in the range  $v_d = 0.0001$ - $0.0033$  m/s.

Fig. 9 illustrates the variability of normalised drive force  $F_{dv}/F_{ds}$  under the influence of transverse vibration as a function of a dimensionless coefficient  $k_v$ , computed using the transverse vibration model [24]. The data points, each corresponding to the result of a single simulation, form a trend indicated by the dashed line. Results obtained from the new model, overlaid in Fig. 9, agree very well with the trend. Unlike longitudinal vibration, in transverse vibration there is reduction of drive force even when  $k_v \leq 1$ .

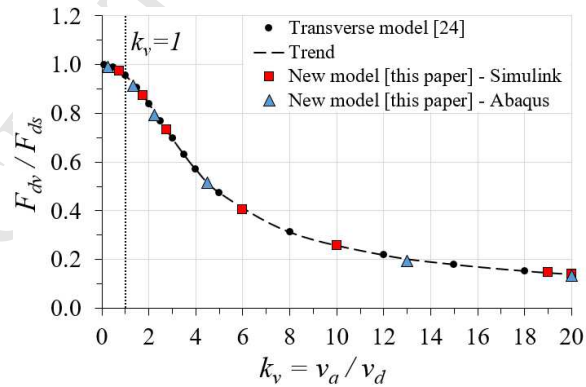

Fig. 9. Change in  $F_{dv}/F_{ds}$  as  $k_v$  increases in transverse vibration

Changes in drive force  $F_d$ , and friction force components  $F_x$  and  $F_y$  with time, computed using the new model when  $k_v = 20$  ( $v_a = 0.010$  m/s), are plotted in Fig. 10 and Fig. 11 in comparison to results obtained from the transverse vibration model [24]. Application of constant drive velocity  $v_d$  at  $t > 0$  sec causes elastic deformation  $s$  to increase, resulting in a steady rise in  $F_d$  until  $t \approx 0.11$  sec at which time breakaway occurs due to  $F_d$  reaching the magnitude of  $\mu F_N = 5.08$  N. Switching on vibration at  $t = 0.14$  sec significantly reduces the magnitude of  $F_d$  as the body continues to slide.

At  $k_v = 20$ , friction force component  $F_x$  undergoes cyclic changes only in magnitude whereas  $F_y$  changes in magnitude and direction, Fig. 11. The average value of  $F_x$  over a single vibration cycle reduces from  $\mu F_N = 5.08$  N when there is no vibration to a lower value when vibration is initiated, hence the drive force is also reduced. Analytical results of the new model obtained via Matlab®/Simulink® show an exact match to the transverse model [24], and numerical results via Abaqus® show subtle differences attributed to the iterative solver.

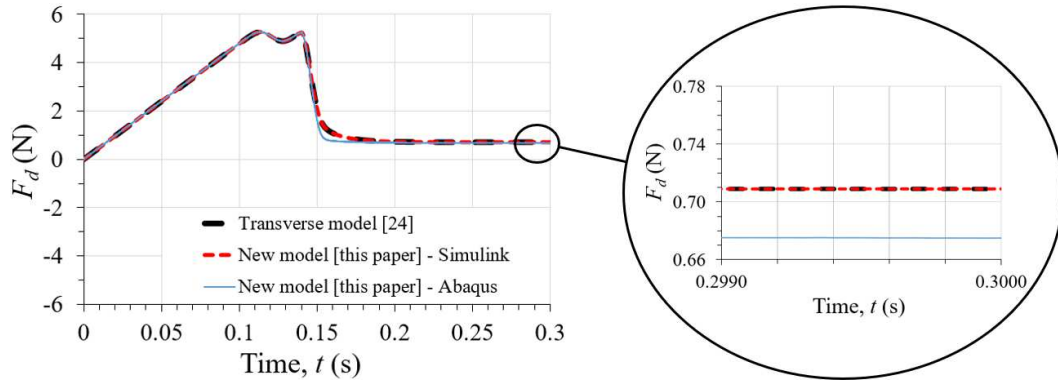

Fig. 10. Comparison of change in  $F_d$  when transverse vibration is switched on,  $k_v = 20$

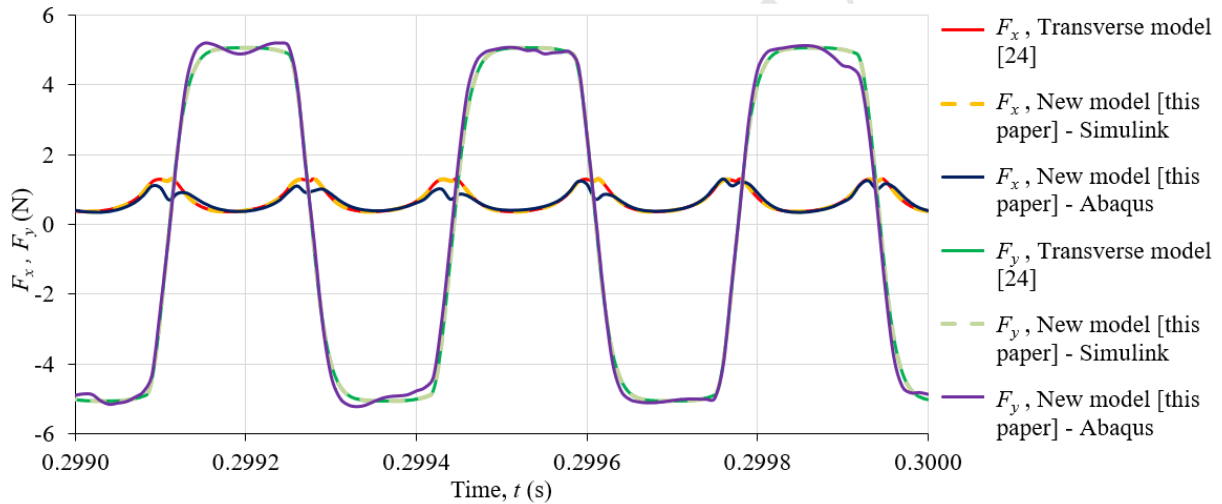

Fig. 11. Comparison of friction force changes during transverse vibration,  $k_v = 20$

### 4.3. Coupled longitudinal-transverse vibration

The new model can also determine the influence of coupled longitudinal-transverse vibration on drive force  $F_d$ . Simulations were performed in different vibration modes  $\theta$  at selected values of  $k_v$  (2, 3, 4, 6 and 20) with parameters described in 4.2;  $v_d = 0.0005$  m/s,  $m = 2$  kg,  $f = 3000$  Hz,  $\mu = 0.1$ ,  $F_N = 50.8$  N,  $k_t = 67.29E6$  N/m,  $k_d = 96068$  N/m. The total simulation time was set to 0.5 sec and a fixed time step of  $1E-6$  sec in Matlab®/Simulink®, and  $1E-5$  sec in Abaqus®, was utilised with vibration of the base starting at 0.14 sec. At  $\eta_y = 0.71$  the transverse vibration model [24] produces a good match to results of all transverse vibration experiments performed at  $f = 3000$  Hz in the range  $v_d = 0.0001-0.0033$  m/s. Since the vibration frequency in the transverse direction will remain 3000 Hz at all vibration modes  $\theta$ , and  $v_d$  is also in the range 0.0001-0.0033 m/s, it is reasonable to assume  $\eta_y = 0.71$  for all vibration modes.

For each selected value of  $k_v$  simulations in 25 different vibration modes  $\theta$  were performed in Matlab®/Simulink®. The results in terms of normalised drive force  $F_{dv}/F_{ds}$  are plotted in Fig. 12 and the corresponding trend for each value of  $k_v$  is also plotted. 3 further simulations for each value of  $k_v$  were performed in Abaqus® and their results are also overlaid in Fig. 12. Abaqus® and Matlab®/Simulink® results are in good agreement; an increase in  $k_v$  results in a decrease in the drive

force in all modes of vibration. Regardless of the value of  $k_v$  the greatest reduction in drive force is always achieved by longitudinal vibration ( $\theta = 0^\circ, 180^\circ$ ). During transition from longitudinal to transverse vibration ( $\theta = 90^\circ, 270^\circ$ ), and vice versa, the shape of curve  $F_{dv}/F_{ds}$  varies depending on the value of  $k_v$ , however, the curve is always symmetrical about  $\theta = 180^\circ$ . This suggests the same result can be obtained at multiple values of  $\theta$ .

## 5. Substituting Dahl with LuGre friction model

The new model is based on friction behaviour per the Dahl model [31], however, it is possible to substitute other dynamic friction models into the formulation, for example, the LuGre friction model [32] which is an extension of the Dahl model and defines the friction force by extending relationship (1) to:

$$F = k_t s + h_t \frac{ds}{dt} + h_v v_r \quad (42)$$

where  $h_t$  is the contact damping coefficient,  $h_v$  is the viscous damping coefficient, and  $ds/dt$  is given by:

$$\frac{ds}{dt} = v_r - \frac{k_t |v_r|}{\mu F_N + (F_S - \mu F_N) e^{-(v_r/v_s)}} s \quad (43)$$

where  $F_S$  is the stiction force and  $v_s$  is the Stribeck velocity. Equations (18) and (31) are then substituted by (44) and (45):

$$s' = \boxed{s_1} + \left[ v_{r1} - \frac{k_t |v_{r1}|}{\mu F_N + (F_S - \mu F_N) e^{-(v_{r1}/v_s)}} \boxed{s_1} \right] \Delta t \quad (44)$$

$$s_1 = s' + \left[ v_{r2} - \frac{k_t |v_{r2}|}{\mu F_N + (F_S - \mu F_N) e^{-(v_{r2}/v_s)}} s' \right] \Delta t \quad (45)$$

and, (38) and (39) substituted by (46) and (47):

$$F_x(t + \Delta t) = \left[ k_t s_1 + h_t \left( \frac{s_1 - \boxed{s_1}}{dt} \right) + h_v \left( \frac{N_1' M'^2 - \boxed{s_1}}{\Delta t} \right) \right] \cos \beta \quad (46)$$

$$F_y(t + \Delta t) = \left[ k_t s_1 + h_t \left( \frac{s_1 - \boxed{s_1}}{dt} \right) + h_v \left( \frac{N_1' M'^2 - \boxed{s_1}}{\Delta t} \right) \right] \sin \beta \quad (47)$$

Setting  $h_t = h_v = F_S = 0$  in the LuGre model reverts to Dahl friction behaviour. To prove this the LuGre model was implemented into the new coupled vibration model for execution in Matlab®/Simulink® at  $k_v = 2$  and 20. Results using the LuGre model are overlaid in Fig. 12 and show an exact match to those with Dahl friction.

If  $h_t$ ,  $h_v$ , and  $F_S$  are non-zero, or if another friction model is used then the value of the transverse vibration transfer coefficient  $\eta_y$  may change since  $\eta_y = 0.71$  is based on a fit fidelity exercise performed by Gutowski and Leus [24] to match their model, which is also based on Dahl friction, to experimental data. If the friction model is changed it is advisable to check the fit fidelity of the model to experimental results and use a new value of  $\eta_y$  if necessary.

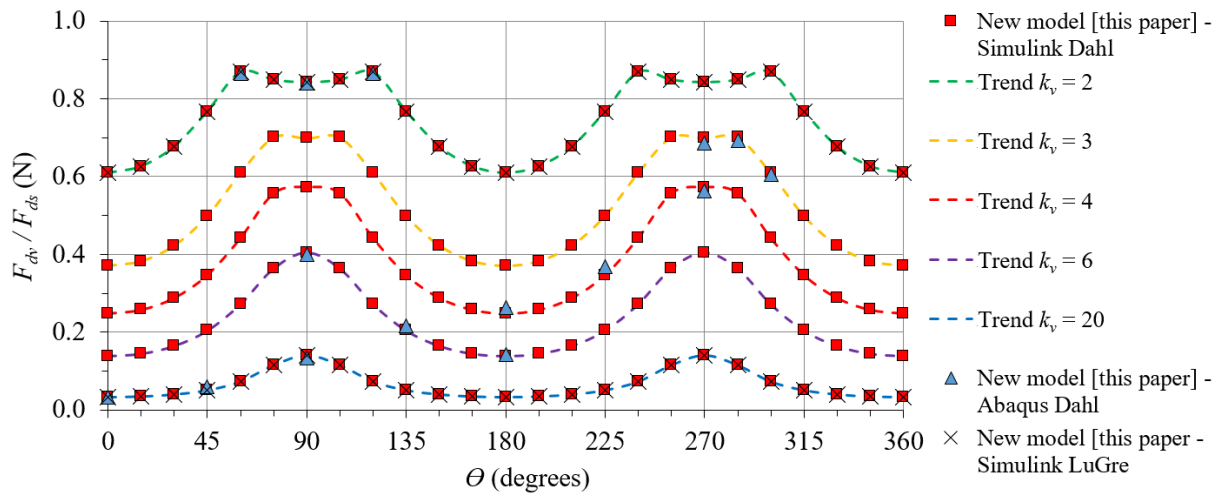

Fig. 12. Changes in  $F_{dv}/F_{ds}$  with  $\theta$  at different values of  $k_y$

## 6. Conclusion

A new analytical model has been developed based on two separate models presented in previous literature [23,24]. The new model is able to describe changes in friction force and drive force during sliding motion of a body over a surface vibrating not only in the longitudinal or transverse mode but also in any mode of coupled longitudinal-transverse vibration. The model has been evaluated analytically in Matlab®/Simulink® and numerically via a specially developed friction subroutine in Abaqus®. Simulations yield good agreement with the models for longitudinal [23] and transverse vibration [24] in previous literature.

The new model can be used in any three-dimensional domain, such as the flat-on-flat contact domain used in this paper where the normal contact pressure has been assumed constant, or a more complex case of gears for example, where the normal contact pressures change as gear teeth move over one another, while multiple teeth enter and exit the gear mesh forming multiple contacts simultaneously. An advantage with Abaqus® is that the complexity of the domain can be increased by modifying the geometry of parts within it and the way in which they interact, whereas in Matlab®/Simulink® additional relationships would have to be introduced to describe these aspects which may result in time-varying contact geometry. In the case of flat-on-flat contact, the greatest reduction in  $F_d$  is achieved by longitudinal vibration, however, friction is in nearly all engineering problems and in other applications a different vibration mode may be more beneficial.

To simulate coupled vibration the value of transverse vibration transfer coefficient  $\eta_y$  must be known and can be estimated using transverse vibration experimental data with the method described by Gutowski and Leus [24]. It is assumed that  $\eta_y$  does not change in value as vibration mode  $\theta$  changes. The new model can then be used to compute changes in friction force and drive force in any mode of vibration. The longitudinal model and transverse model have previously been validated against experiments [23,24] and have been used in this paper as basis for validating the new model, however, experimental results for coupled vibration are not currently available. This provides scope for future work. Also, the influence on  $\eta_y$  of using dynamic friction models other than the Dahl model is currently unknown.

## References

- [1] Hargreaves DJ, Planitz A. Assessing the energy efficiency of gear oils via the FZG test machine. *Tribology International* 2009;42(6):918-25.
- [2] Marques PMT, Fernandes CMCG, Martins RC, Seabra JHO. Efficiency of a gearbox lubricated with wind turbine gear oils. *Tribology International* 2013;71:7-16.
- [3] Cardoso NFR, Martins RC, Seabra JHO, Igartua A, Rodríguez JC, Luther R. Micropitting performance of nitrided steel gears lubricated with mineral and ester oils. *Tribology International* 2009;42(1):77-87.



- [4] Shen M, Luo J, Wen S. The tribological properties of oils added with diamond nano-particles. *Tribology Transactions* 2001;44(3):494-8.
- [5] Chu HY, Hsu WC, Lin JF. The anti-scuffing performance of diamond nano-particles as an oil additive. *Wear* 2010;268(7):960-7.
- [6] Zhou G, Zhu Y, Wang X, Xia M, Zhang Y, Ding H. Sliding tribological properties of 0.45% carbon steel lubricated with Fe<sub>3</sub>O<sub>4</sub> magnetic nano-particle additives in base oil. *Wear* 2013;301(1-2):753-7.
- [7] Moorthy V, Shaw BA. Contact fatigue performance of helical gears with surface coatings. *Wear* 2012;276-277:130-40.
- [8] Xiao Y, Shi W, Luo J, Liao Y. The tribological performance of TiN, WC/C and DLC coatings measured by the four-ball test. *Ceramics International* 2013;40(5):6919-25.
- [9] Baker HD, Claypoole W, Fuller DD. *Proceedings of the First US National Congress of Applied Mechanics* 1952;23.
- [10] Fridman HD, Levesque P. Reduction of static friction by sonic vibrations. *Journal of Applied Physics* 1959;30(10):1572-5.
- [11] Godfrey D. Vibration reduces metal to metal contact and causes an apparent reduction in friction. *Tribology Transactions* 1967;10(2):183-92.
- [12] Lenkiewicz W. The sliding friction process-effect of external vibrations. *Wear* 1969;13(2):99-108.
- [13] Hess DP, Soom A. Normal vibration and friction under harmonic loads: Part I-Hertzian contacts. *Journal of Tribology* 1991;113(1):80-6.
- [14] Abdo J, Tahat M. The Effect of Frequency and Amplitude of Vibration on the Coefficient of Friction for Metals. *WSEAS Transactions on Applied and Theoretical Mechanics* 2008;3(7):265-74.
- [15] Chowdhury MA, Helali MM. The effect of amplitude of vibration on the coefficient of friction for different materials. *Tribology International* 2008;41(4):307-14.
- [16] Mitskevich AM. Motion of the body over tangentially vibrating surface taking account of friction. *Soviet Physics-Acoustics* 1968;13(3):343-51.
- [17] Skare T, Stahl JE. Static and dynamic friction processes under the influence of external vibrations. *Wear* 1992;154(1):177-92.
- [18] Mutuonga S, Onoda J. New gravity compensation method by dither for low-g simulation. *Journal of Spacecraft and Rockets* 1995;32(2):364-9.
- [19] Littmann W, Storck H, Wallaschek J. Sliding friction in the presence of ultrasonic oscillations: superposition of longitudinal oscillations. *Archive of Applied Mechanics* 2001;71(8):549-54.
- [20] Littmann W, Storck H, Wallaschek J. Reduction of friction using piezoelectrically excited ultrasonic vibrations. *Proceedings of SPIE - The International Society for Optical Engineering* 2001;4331:302-11.
- [21] Storck H, Littmann W, Wallaschek J, Mracek M. The effect of friction reduction in presence of ultrasonic vibrations and its relevance to travelling wave ultrasonic motors. *Ultrasonics* 2002;40(1-8):379-83.
- [22] Kumar VC, Hutchings IM. Reduction of sliding friction of metals by the application of longitudinal or transverse ultrasonic vibration. *Tribology International* 2004;37(10):833-40.
- [23] Gutowski P, Leus M. The effect of longitudinal tangential vibrations on friction and driving forces in sliding motion. *Tribology International* 2012;55(6):108-18.
- [24] Gutowski P, Leus M. Computational model for friction force estimation in sliding motion at transverse tangential vibrations of elastic contact support. *Tribology International* 2015;90:455-62.
- [25] Tsai CC, Tseng CH. The effect of friction reduction in the presence of in-plane vibrations. *Archive of Applied Mechanics* 2006;75(2):164-76.
- [26] Jimma T, Kasuga Y, Iwaki N, Miyazawa O, Mori E, Ito K, Hatano H. An application of ultrasonic vibration to the deep drawing process. *Journal of Materials Processing Technology* 1998;80-81:406-12.
- [27] Siegert K, Ulmer J. Influencing the Friction in Metal Forming Processes by Superimposing Ultrasonic Waves. *CIRP Annals - Manufacturing Technology* 2001;50(1):195-200.

- [28] Egashira K, Mizutani K, Nagoa T. Ultrasonic Vibration Drilling of Microholes in Glass. *CIRP Annals - Manufacturing Technology* 2002;51(1):339-42.
- [29] Schneider Y, Zahn S, Schindler C, Rohm H. Ultrasonic excitation affects friction interactions between food materials and cutting tools. *Ultrasonics* 2009;49(6-7):588-93.
- [30] Dahl P. A Solid Friction Model. Technical Report TOR-0158H3107-181-1. The Aerospace Corporation, El Segundo, CA 1968.
- [31] Dahl P. Solid friction damping of mechanical vibrations. *AIAA Journal* 1976;14(12):1675-82.
- [32] Canudas de Wit C, Olsson H, Astrom KJ, Lischinsky P. A new model for control of systems with friction. *IEEE Transactions on Automatic Control* 1995;40(3):419-25.

ACCEPTED MANUSCRIPT

**Highlights**

- New analytical model developed for coupled longitudinal and transverse vibration
- Any in-plane vibration mode including longitudinal and transverse can be simulated
- Matlab®/Simulink® and Abaqus® simulation results are in good agreement
- Greatest friction reduction is achieved by longitudinal vibration mode
- It is possible to substitute in dynamic friction models other than the Dahl model