

An Investigation into the Mechanisms of Acute Effects of Dynamic Stretching on Ankle Joint Mechanics and Running Economy

A thesis submitted for the Degree of Doctor of Philosophy

by

George Michael Pamboris

Centre for Human Performance, Exercise and Rehabilitation
Department of Life Sciences, College of Health and Life Sciences
Brunel University London



Brunel
University
London

Abstract

Warm-up routines commonly include stretching to increase flexibility (joint range of motion - ROM), optimise performance, and reduce the risk of injury. Literature suggests that static stretching as part of the warm-up routines decreases force and power production compared to an active warm-up or a warm-up including dynamic stretching, and therefore could be detrimental to performance. This has led to an increased interest in the use of dynamic stretching by many athletes while the benefits of such interventions and their potential mechanisms of action are not well understood.

Studies presented in this thesis were conducted to examine the effects of acute dynamic stretching on aspects of performance (e.g. torque production capacity of the plantarflexors and running economy) and to identify possible neuromechanical mechanisms underpinning any potential changes. Furthermore, we attempted to examine whether altered pain tolerance/perception to stretch may be a contributing factor to the increased ROM using adaptations in the neural substrates involved by using functional magnetic resonance imaging (fMRI) technique.

In the first study, both slow dynamic stretching and fast dynamic stretching increased ROM, and this was due to an increased tendon elongation. Importantly, dynamic stretching was not detrimental to the torque producing capacity of the ankle plantarflexors. Effects of dynamic stretching on the sensorimotor performance remained mainly unclear. Employment of shear wave elastography technique in the second study suggested an increase in muscle stiffness, a decrease in fascicle strain, and showed an increase in muscle thickness after dynamic stretching, supporting an increase in tendon compliance as a contributing factor to increased flexibility after dynamic stretching. In the third study, the improved running economy by dynamic stretching may be attributable to the decreased dynamic joint ankle and vertical stiffness. The fMRI study was not conclusive due to methodological issues. Present findings have practical implications for the use of dynamic stretching in sporting contexts.

Table of Contents

Abstract.....	iii
Table of Contents	iv
List of Tables	xii
List of Figures	xix
Acknowledgements.....	xvii
Ethics Approval.....	xix
List of Abbreviations.....	xx
Publications and Conference Presentations	xxi
Chapter 1 General Introduction.....	1
Thesis Overview	2
Thesis Structure.....	3
Chapter 2 Critical Review of the Literature	5
Introduction.....	5
Anatomical and Physiological Characteristics of the Muscle-Tendon Complex.....	5
Skeletal Muscle Structure	6
Titin Filaments.....	8
Tendon	8
Mechanics of Muscle-Tendon Unit.....	12
Architectural and Mechanical Characteristics of muscle and tendon.....	13
Force-Length Relationship	14

Force-Velocity Relationship	15
Creep Deformation, Stress Relaxation, and Hysteresis	16
Stiffness	18
Stress, Strain and Young's Modulus	21
Pennation Angle and Fascicle Length.....	21
Force Production Capacity of the Muscle-Tendon Unit is Affected by Structural and Mechanical Properties of the Muscle and Tendon	22
Mechanisms of Stretching	24
Muscle Mechanical Changes	24
Influence of Stretching on Muscle Architecture	26
Passive and Active Loading on Tendon	29
Stretching of Other Structures – Fascia	30
Neuro-physiological Mechanisms.....	31
Stretch Tolerance Models	35
Types of Stretching.....	38
Static Stretching.....	39
Ballistic Stretching.....	41
Proprioceptive Neuromuscular Facilitation Stretching.....	41
Dynamic Stretching.....	43
Acute Effects of Dynamic Stretching on Aspects of Performance	45
Maximum Range of Motion and Passive Force/Torque	45
Strength, Power, and Speed	46

Agility, Balance and Response Time.....	77
Endurance - Running Economy	78
Prevention of Injury	86
Proposed Physiological Mechanisms for Improved Performance after Dynamic Stretching	90
Rehearsal of Movement	90
Heart Rate, Muscle and Core temperature	90
Neural Adaptations.....	91
Post-Activation Potentiation	92
Muscle-Tendon Unit Stiffness	94
Summary	94
Chapter 3 Effect of Different Dynamic Stretching Velocities on Plantarflexor Muscles Neuromechanical and Sensorimotor Performance.....	96
Introduction.....	96
Materials and Methods	99
Participants	99
Procedures.....	100
Warm-Up.....	101
Dynamic Stretching Protocol.....	102
Participant Preparation for Testing.....	103
Electrode Placement.....	104
Assessment of Neuromechanical Performance	105

Assessment of Sensorimotor Performance	111
Statistical Analysis	112
Results.....	114
Performance Outcomes	114
Neuromechanical Performance.....	118
Sensorimotor Performance	122
Discussion	123
Neuromechanical Performance.....	124
Passive Ankle Dorsiflexion ROM and Muscle and Tendon Properties	124
Maximum Strength	127
Sensorimotor Performance	131
Conclusion.....	133
Chapter 4 Effects of an Acute Bout of Dynamic Stretching on Biomechanical Properties of the Gastrocnemius Muscle Determined by Shear Wave Elastography	134
Introduction.....	134
Methods.....	137
Participants	137
Study Design.....	138
Experimental Procedures.....	139
Dynamic Stretching Protocol.....	139
Dynamometer Testing of ROM	140

Muscle Shear Wave Speed and Fascicle Strain	141
Ultrasound Processing	142
Passive Muscle Fascicle Strain.....	143
Statistical Analysis	143
Reliability of Measurements	145
Results.....	146
Passive Ankle Flexibility	147
Total ROM.....	147
Shear Wave Speed	148
Muscle Fascicle Strain	148
Muscle Thickness.....	151
Reliability of Measurements	151
Discussion	152
Effect of Dynamic Stretching on Flexibility	152
Effect of Dynamic Stretching on Muscle Mechanical Properties	152
Reproducibility of Shear Wave Speed Measurements Using Ultrasound Shear- Wave Elastography	156
Conclusions	156
Chapter 5 Influence of Dynamic Stretching on Ankle Joint Stiffness, Vertical Stiffness, and Running Economy during Treadmill Running.....	157
Introduction.....	157
Methods.....	162

Participants	162
Study Design.....	163
Anthropometry.....	163
Dynamic Stretching and Control Condition Interventions.....	163
Motion Analysis	164
Dynamic Joint Stiffness.....	169
Vertical stiffness.....	170
Exercise Protocol	170
Online Gas Analysis.....	171
Calculation of Running Economy	172
Electromyography	173
Statistical Analysis	173
Reliability of Measurements	175
Results.....	176
Physiological Measures	178
Biomechanical Measures	179
Repeatability of Stiffness Measures.....	180
Discussion	181
Limitations.....	185
Conclusion.....	186

Chapter 6 Neural Correlates of Pain Threshold during Passive Stretching. Is there a Relationship between Pain Tolerance and Increased Range of Motion? – A Pilot Study	187
Introduction	187
Materials and Methods	194
Participants	194
Experimental Setup	194
Experimental Design and Timing	195
Pain Perception	197
MRI Data Acquisition	197
fMRI Data Analysis	198
Statistical Analyses	200
Results	201
fMRI Data	201
Pain Tolerance	202
Discussion	215
Chapter 7 General Discussion	220
Effect of Different Dynamic Stretching Velocities on Plantarflexor Muscles Neuromechanical and Sensorimotor Performance	222
Effects of an Acute Bout of Dynamic Stretching on Biomechanical Properties of the Gastrocnemius Muscle Determined by Shear Wave Elastography	223
Influence of Dynamic Stretching on Ankle Joint Stiffness, Vertical Stiffness, and Running Economy during Treadmill Running	224

Neural Correlates of Pain Threshold during Passive Stretching. Is there a Relationship between Pain Tolerance and Increased Range of Motion? – A Pilot Study	225
Limitations	225
Conclusion	227
Practical Implications	228
Directions for Future Research	228
Chapter 8 References	22032

List of Tables

Table 2.1. Effect of short-term DS on strength, power and speed performance.....	52
Table 3.1. Coefficients for gastrocnemius length (Grieve et al., 1978).....	109
Table 3.2. Descriptive statistics and mean differences in the SDS performance measures	114
Table 3.3. Descriptive statistics and mean differences in the FDS performance measures	116
Table 4.1. Shows descriptive statistics and mean differences in the DS performance measures	146
Table 5.1. Descriptive statistics and mean differences in the Control and DS performance measures	176
Table 5.2. Repeatability results for Joint Stiffness and Vertical Stiffness	180
Table 6.1. Mean associated with the VAS at pre-and post-intervention at the three ankle angles	202
Table 6.2. Loci of Activation for the condition Main Effects for Pre 0°	203
Table 6.3 Loci of Activation for the condition Main Effects for Pre15°	203
Table 6.4 Loci of Activation for the condition Main Effects for Pre Max.....	204
Table 6.5. Loci of Activation for the condition Main Effects for Post 0°.....	205
Table 6.6. Loci of Activation for the condition Main Effects for Post 15°.....	206
Table 6.7. Loci of Activation for the condition Main Effects for Post Max.	208
Table 6.8. Loci of Activation for comparisons between the pre-conditions contrasts	208
Table 6.9. Loci of Activation for comparisons between the post-conditions contrasts	209

Table 6.10 Loci of Activation for comparisons between the pre-and post-conditions contrasts..... 210

List of Figures

Figure 2.1. Schematic drawing of muscle illustrating three types of connective tissue	6
Figure 2.3. Schematic summary of the sarcomere's principal structures	7
Figure 2.4. The organisation of tendon from collagen fibrils to the entire tendon	10
Figure 2.5. A highly diagrammatic model of the muscle-tendon unit displaying the parallel elastic component, series elastic component, contractile component and viscous component.....	12
Figure 2.6. Force-length relationship in isolated muscle.	15
Figure 2.7. Force-velocity relationship of isolated muscle during concentric, isometric and eccentric muscle action.	16
Figure 2.8. Hysteresis. Typical loading (top) and unloading curves (bottom).	18
Figure 2.9. Passive force and stiffness of the muscle-tendon unit.	19
Figure 2.10. Illustration of the stretch reflex (autogenic facilitation) and reciprocal inhibition	33
Figure 2.11. Illustration of the Golgi tendon reflex.	35
Figure 2.12. Range of movement increase owing to a change in tissue stiffness. ...	36
Figure 2.13. Range of movement increase as a shift along the force-elongation curve	37
Figure 2.14. Factors affecting running economy.	80
Figure 3.1. Schematic representation of the study protocol	101
Figure 3.2 Start and finish position of dynamic stretching protocol	102
Figure 3.3. Participant on the dynamometer for the assessment of ankle plantarflexors neuromuscular performance.	103

Figure 3.4. A picture of the experimental setup.....	104
Figure 3.5. A representation of how the fascicle length, superficial and deep aponeuroses of the medial gastrocnemius muscle were identified using the Matlab script.....	108
Figure 3.6. The musculotendinous model used to estimate tendon length changes.	110
Figure 3.7. Maximum passive dorsiflexion before (pre) and after (post) slow dynamic stretching (SDS) and fast dynamic stretching (FDS).....	118
Figure 3.8. Maximum concentric torque before (pre) and after (post) slow dynamic stretching (SDS) and fast dynamic stretching (FDS).....	120
Figure 3.9. Muscle strain before (pre) and after (post) slow dynamic stretching (SDS) and fast dynamic stretching (FDS).....	121
Figure 3.10. Tendon strain before (pre) and after (post) slow dynamic stretching (SDS) and fast dynamic stretching (FDS).....	121
Figure 4.1. Shear wave speed of the medial gastrocnemius muscle plotted against fascicle strain pre-dynamic stretching.	149
Figure 4.2. Shear wave speed of the medial gastrocnemius muscle plotted against ankle angle pre-dynamic stretching.....	149
Figure 4.3. Shear wave speed of the medial gastrocnemius muscle plotted against fascicle strain post-dynamic stretching.....	150
Figure 4.4. Shear wave speed of the medial gastrocnemius muscle plotted against fascicle strain post-dynamic stretching.....	150
Figure 5.1. Start and finish position standing of dynamic stretching protocol.....	164
Figure 5.2. Laboratory set-up with the lab-coordinate system during participant testing.....	165

Figure 5.3. An example of the lower body model in Visual3D used for this research	167
Figure 5.4. Attaching the Cosmed K5 on one of the participants for pulmonary gas collection.	172
Figure 5.5. $\dot{V}O_2$ (mL kg ⁻¹ min ⁻¹) to running speed relationships, for the dynamic stretching and control condition for the first four stages.	179
Figure 6.1. Cortical and sub-cortical regions involved in pain perception, their inter-connectivity and ascending pathways.	191
Figure 6.2 The experimental set-up used in the study before inserting the straps on the lower legs to secure the participant.	195
Figure 6.3. Schematic of the data collection procedure.....	196
Figure 6.4. Stages of image processing	200
Figure 6.5. Thresholded signal increases of the group main effect contrasts for Pre 0°, Pre 15°, Pre Max, Post 0°, Post 15°, Post Max.	211
Figure 6.6. Thresholded signal increases of the between pre-and between post condition contrasts for Pre 15° > Pre 0°, Pre Max > Pre 0°, Pre 15° > Pre 0° and Post Max > Post 0°.....	212
Figure 6.7. Thresholded signal increases of the between pre-and post-condition contrasts for Post 15° >Pre 15° and Post Max > Pre Max.	213
Figure 6.8. Realignment parameters for participants 1-11	215

Acknowledgements

There are a lot of people that helped me significantly throughout these four years to reach the end of this beautiful journey. All those people were very influential and supportive, and I would like to thank them and show my appreciation for what they did.

First and more importantly, I would like to thank my supervisory team, Dr Amir Mohagheghi, Dr Marika Noorkoiv and Professor Bill Baltzopoulos. Thank you all so much for the help, the patience, the guidance and the continuous support you showed me through this journey. To Dr Amir Mohagheghi who undertook to be my primary supervisor midway through the second year, thank you, Amir, for all the insight and advice and knowledge you have passed me on over the last years. To Dr Marika Noorkoiv for taking the time to provide advice and instructions regarding 3D motion analysis and ultrasonography. Bill, thank you so much for never letting me down and for giving me the opportunity to learn from you.

Thanks also to the numerous members of academic staff who have provided both scientific and professional advice. Dr Lee Romer and Mr Tom Howes for his help during the testing sessions. My time has been made more enjoyable by the friends I have made. The past and present PhD students Patrick, Adam, Toby, Viktor, Eurico, Joao, Jamie, Pedro, Giorgia, Adele, Jennifer, Anastasia, Marcelo and Colm. To Patrick who has listened to me both moan and getting excited about new concepts foreign to him.

I would like to show my immense gratitude to some other individuals who have helped along the way. Mrs Hulya Gokalp, Mr Robert Marzilger for their help with the Matlab scripts, Assistant Professor Douglas Powell for his help with Visual3D and Dr Jason Martin for his guidance with fMRI data analysis. My special thanks to Miss Sara Horne, for the technical support.

To all the participants who spent their valuable time and volunteered to take part in my studies.

Finally, I would like to thank my parents, my brother and my grandparents. I am eternally grateful to them for supporting a student for so long, helping me reach

my goals and who believed in me even when I didn't believe in myself. This work is dedicated to you. I certainly would not have gotten here without you.

Ethics Approval

Ethics approval was granted by the Research Ethics Committee of the Department of Life Sciences at Brunel University London. The ethics approval references were:

Chapters 3-6:

- RE42–13 Title: The effect of different dynamic stretch velocities on plantar flexor muscles neuromechanical and sensorimotor performance. Approved 16th March 2015. Ethics approval covered Chapter 3: Effect of different dynamic stretching velocities on plantarflexor muscles neuromechanical and sensorimotor performance; Chapter 4: Effects of an acute bout of dynamic stretching on biomechanical properties of the gastrocnemius muscle determined by Shear Wave Elastography.
- RE26–14 Title: The influence of dynamic stretching on plantar flexor muscle mechanical and morphological properties and running economy. Approved 4th October 2016. Ethics approval covered Chapter 5: The influence of dynamic stretching on ankle joint stiffness, vertical stiffness, and running economy during treadmill running.
- RE29–14 Title: Neural correlates of pain threshold during passive stretching. Is there a relationship between pain tolerance and increased range of motion? Approved 11th May 2015. Ethics approval covered Chapter 6: The influence of dynamic stretching on ankle joint stiffness, vertical stiffness, and running economy during treadmill running.

List of Abbreviations

CI	confidence interval
COM	centre of mass
CV	coefficient of variation
EMG	electromyography
ES	effect size
fMRI	functional magnetic resonance imaging
GRF	ground reaction force
H:Q strength ratio	Hamstrings-Quadriceps strength ratio.
H-Reflex	Hoffman Reflex
ICC	Intraclass correlation coefficient
MG	Medial Gastrocnemius
MVIC	maximal voluntary isometric contraction
PNF	Proprioceptive neuromuscular facilitation
PAP	Post-Activation Potentiation
r	Pearson's product moment correlation coefficient
RMS	root mean square
ROM	range of motion
SOL	Soleus
SSC	stretch shortening cycle
TA	Tibialis anterior
TE	typical error
TMS	transcranial magnetic stimulation
$\dot{V}O_2$	rate of oxygen uptake
$\dot{V}O_{2max}$	maximum rate of oxygen uptake
$\dot{V}O_{2peak}$	peak oxygen uptake

Publications and Conference Presentations

Articles

Pamboris, G., Noorkoiv, M., Baltzopoulos, V., Gokalp, H., Marzilger, R., & Mohagheghi, A. (2017). *Effects of an acute bout of dynamic stretching on biomechanical properties of the gastrocnemius muscle determined by shear wave elastography*. PLoS ONE, 13(5), e0196724.
<http://doi.org/10.6084/m9.figshare.5919496>.

Pamboris, G., Noorkoiv, M., Mohagheghi, A., & Baltzopoulos, V. (2017). *Dynamic stretching is not detrimental to ankle plantarflexor muscles neuromechanical and sensorimotor performance*. Manuscript in preparation.

Abstracts in Scientific Conferences

Pamboris, G., Mohagheghi, A., Noorkoiv, M., & Baltzopoulos, V. (2016). The acute effects of dynamic stretching on the sensorimotor and neuromechanical performance of the ankle plantarflexors. In *21st Annual Congress of the European College of Sport Science* (pp. 357–358). Vienna, Austria.

Pamboris, G., Mohagheghi, A., Noorkoiv, M., & Baltzopoulos, V. (2016). Shear wave elastography of muscle and tendon after an acute dynamic stretching protocol. In *21st Annual Congress of the European College of Sport Science* (p. 609). Vienna, Austria.

Chapter 1 General Introduction

Flexibility, defined as the maximum range of movement achievable without injury at a joint or a series of joints (Thacker, Gilchrist, Stroup, & Kimsey, 2004) is a fundamental component of fitness and performance, and an essential element in most training protocols. Flexibility can be limited by the inert structures around a joint, compliance of both the contractile and non-contractile components of the muscle-tendon unit, and neural factors (e.g. muscle reflexes) controlling muscle activation.

Stretching protocols, whose aim is to achieve increased flexibility or range of motion (ROM), are key components of a warm-up routine as a high level of flexibility is important in many types of performance. This is suggested to be achieved by increasing the muscle temperature without causing fatigue (Woods, Bishop, & Jones, 2007). In addition, it has been suggested that warming-up can make sports injuries less likely in certain circumstances. For example, dynamic warm-up activities cause vasodilation which results in increased blood and oxygen flow to the peripheral tissues. When blood vessels dilate, the regional blood flow is increased due to a decrease in vascular resistance, and the body temperature rises allowing muscles, tendons, ligaments, and joints to become warmer and more flexible, which in turn may make them less susceptible to injury (Hewett, Lindenfeld, Riccobene, & Noyes, 1999; Prentice, 2010). Furthermore, it is suggested that stretching may help to achieve optimum performance enhancement by contributing to maximal muscular strength and/or power production (Young & Behm, 2002). Thus, stretching in its different forms is regarded as an essential component of numerous training programs (Caplan, Rogers, Parr, & Hayes, 2009) and rehabilitation protocols (Feland, Myrer, Schulthies, Fellingham, & Measom, 2001; Malliaropoulos, Papalexandris, Papalada, & Papacostas, 2004).

Physiotherapists, athletic trainers, and coaches often recommend static stretching to be performed prior to exercise as part of a comprehensive warm-up to help facilitate proper muscle length in order to prepare the muscle for physical activity and avoid overstretching which may lead to injury. However, these claims are now refuted, with injury prevention regarded as unlikely (Shrier, 1999; Thacker et al., 2004), while there is evidence to show significant reductions in strength (Bacurau

et al., 2009; Costa et al., 2009; Herda et al., 2008; Morse, Degens, Seynnes, Maganaris, & Jones, 2008), power (Manoel, Harris-Love, Danoff, & Miller, 2008; Samuel, Holcomb, Guadagnoli, Rubley, & Wallmann, 2008), speed (Fletcher & Anness, 2007; Fletcher & Jones, 2004; Nelson, Driscoll, Landin, Young, & Schexnayder, 2005; Sayers, Farley, Fuller, Jubenville, & Caputo, 2008), jump performance (Holt & Lambourne, 2008; Pearce, Kidgell, Zois, & Carlson, 2009) and agility (Little & Williams, 2006) with static stretching as part of a warm-up routine. Interestingly, despite all previous findings, many athletes still include static stretching in their warm-up and even before the events in which force, power, and sprint performance are essential for performance. A possible explanation could be the fact that athletes are completely unaware of these adverse effects of static stretching on performance. Additionally, some athletes may not want to abandon practising static stretching due to habitual-psychological reasons. Young (2007) reported that since static stretching is a traditional warm-up practice if it is suddenly eliminated this element might affect some athletes negatively, especially if they have a history of using it and a belief in its benefits.

Recent evidence indicates that dynamic stretching, on the other hand, could enhance ROM (Mizuno & Umemura, 2016; Samukawa, Hattori, Sugama, & Takeda, 2011), facilitate power production (Manoel et al., 2008; Yamaguchi & Ishii, 2005; Yamaguchi, Ishii, Yamanaka, & Yasuda, 2007), and sprint performance (Fletcher & Anness, 2007; Fletcher & Jones, 2004; Holt & Lambourne, 2008; Hough, Ross, & Howatson, 2009; Jagers, Swank, Frost, & Lee, 2008; Little & Williams, 2006; Pearce et al., 2009) leading to recommendations for dynamic stretching as a pre-performance routine rather than static stretching. The mechanisms underlying the potential effect of dynamic stretching on performance, is, however, less understood.

Thesis overview

This thesis aims to further the understanding of the effect of performing dynamic stretching on flexibility and aspects of muscular performance. Specifically, the thesis will examine the effects of an acute bout of dynamic stretching on plantarflexor torque, and alteration in the mechanical properties of muscle and

tendon *in vivo* in the triceps surae muscle-tendon unit. Mechanisms underlying the expected increased flexibility are explored using a sensory (neural) and a mechanical model. The mechanical model predicts alterations in the mechanical properties of the muscle-tendon unit (e.g. strain, muscle architecture, stiffness measured by shear wave elastography) in response to the dynamic stretching protocol. On the other hand, alterations in the sensory/sensory-motor performance (e.g. proprioceptive acuity; force matching, position sense) may suggest involvement of a neural mechanism in response to dynamic stretching, which in turn can lead to alteration in the physiological aspects of performance exemplified by running economy. Furthermore, we attempted to examine whether a change in stretch/pain tolerance may be a potential contributing mechanism to the increased ROM after stretching. The plantarflexors were the targeted muscle-tendon unit for this examination because of their importance in many daily and sporting activities.

Thesis structure

This thesis contains a series of progressively linked studies describing the effect of acute dynamic stretching protocols on aspects of performance and examines potential neuromechanical, and sensorimotor, mechanisms underlying them.

Chapter 2 presents a comprehensive review of the literature related to the thesis, along with the specific aims and hypothesis of the thesis focusing on the theories behind increased flexibility and increased performance after dynamic stretching.

Chapter 3 determines and compares the effect of two dynamic stretching velocities on ankle plantarflexor torque during different modes of contraction, and examines the mechanisms underlying the effects of dynamic stretching on force production by exploring the neural and mechanical aspects of voluntary isometric plantarflexion. Furthermore, this chapter examines if the employed acute dynamic stretching protocols compromise joint proprioceptive acuity. The *in vivo* changes in muscle morphology and neuromuscular activation before and after dynamic stretching were identified and discussed individually for the muscle and tendon.

Chapter 4 explores the effects of dynamic stretching on shear wave speed as an indirect measure of stiffness, and whether altered muscle stiffness, fascicle strain, and muscle thickness of the medial gastrocnemius (MG) muscle are potential mechanisms contributing to the increased ROM after a dynamic stretching protocol.

Chapter 5 explores the influence of acute dynamic stretching on running economy measured as oxygen cost, ankle joint dynamic and vertical stiffness to investigate the idea of whether and how altering the mechanical properties of the lower limb by a dynamic stretching protocol can influence running economy.

Chapter 6 tries to assess the possibility of identifying neural mechanisms of pain/stretch tolerance as a contributor to increased ROM about a joint during static stretching using functional magnetic resonance imaging (fMRI).

Finally, **chapter 7** provides a general discussion of the findings of each study, limitations of the thesis, and directions for future research.

Chapter 2 Critical Review of the Literature

Introduction

Different types of interventions are used as part of a warm-up to increase sports performance and decrease injury risk (Agre, 1985; Alter, 2004; Bishop, 2003a; Woods, Bishop, & Jones, 2007). Acute stretching is commonly performed in these pre-activity routines to temporarily increase flexibility by increasing the muscle-tendon unit extensibility, which may or may not be associated with decreasing the muscle-tendon unit stiffness (Alter, 2004; Cramer et al., 2004; Kay & Blazevich, 2008). Application of stretching routines is based on the assumption that the neuromechanical properties of the muscle-tendon unit, which may be one of the aetiologies of musculotendinous strain injury, can be affected by stretching. However, warm-up protocols also include some types of cardiovascular work and intense muscular work in addition to muscular stretching, and therefore, the isolated effect of stretching on performance and prevention of injury is difficult to assess. A review of published studies (Gleim & McHugh, 1997; Thacker, Gilchrist, Stroup, & Kimsey, 2004; Weldon & Hill, 2003; Witvrouw, Mahieu, Danneels, & McNair, 2004) suggest an equivocal support for stretching as an injury prevention tool.

While numerous articles are reporting the effects of acute static stretching on performance and the mechanisms underlying them, there is little evidence for the effect of dynamic stretching on the mechanical properties of the muscle-tendon unit and function. The purpose of this literature review is 1) to examine possible mechanisms underlying an expected increase in flexibility after stretching, and 2) to report the current knowledge on the acute effects of dynamic stretching on muscle neuromechanical and sensorimotor performance. The chapter will also highlight the areas that need further investigation and clarify the aims of the current research.

Anatomical and Physiological Characteristics of the Muscle-Tendon Complex

The human body contains numerous structures made of connective tissue, but regarding flexibility and stretching, four structures are of greatest importance: muscles, tendons, ligaments, and fascia (Alter, 2004). Structural and mechanical

properties of these components determine the behaviour of the muscle-tendon unit in response to stretching.

Skeletal Muscle Structure

Skeletal muscle is a hierarchical composite structure of contractile protein filaments and viscoelastic connective tissue (Fukunaga, Kawakami, Kuno, Funato, & Fukashiro, 1997). The whole muscular structure is encased in a sheath - the epimysium. The central part of the muscle is called the muscle belly. The muscle belly is made of smaller compartments called fasciculi. In turn, each fascicle consists of approximately 100-150 individual muscle fibres grouped in bundles covered by the perimysium. Each muscle fibre is surrounded by a thin membrane (endomysium). These are single large cells of approximately 50 μm in diameter and up to several centimetres in length which are formed by the fusion of many individual cells during development (Figure 2.1). The muscular membranes stretch over the entire length of the muscle from tendon to tendon, intimately linking the contractile and inert portions of the muscle. The whole structure is often referred to as the 'musculotendinous' unit.

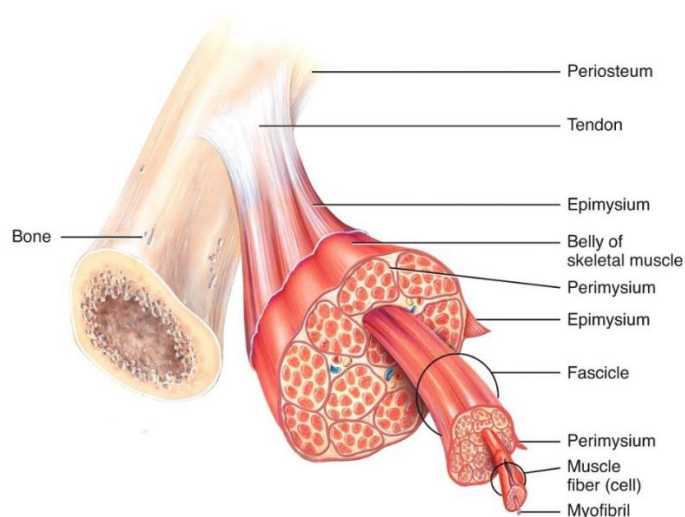

Figure 2.1. Schematic drawing of muscle illustrating three types of connective tissue: epimysium (the outer layer), perimysium (surrounding each fasciculus, or group of fibres), and endomysium (surrounding individual fibres). Copyright © John Wiley and Sons, Inc.

Each muscle fibre is composed of many smaller units called myofibrils which run the length of the muscle fibre. Each myofibril comprises of long, thin strands of serially linked sarcomeres, the contractile unit of the muscle, which are responsible for the striated appearance of skeletal and cardiac muscle (Alter, 2004). The sarcomeres (which are approximately 2.3 μm long) consist of thick longitudinal filaments of myosin (about 15 nm in diameter) and thin filaments of actin (about 7 nm in diameter) arranged between the so-called Z-discs (Hoppeler & Billeter, 2003) and titin (Alter, 2004) (Figure 2.2).

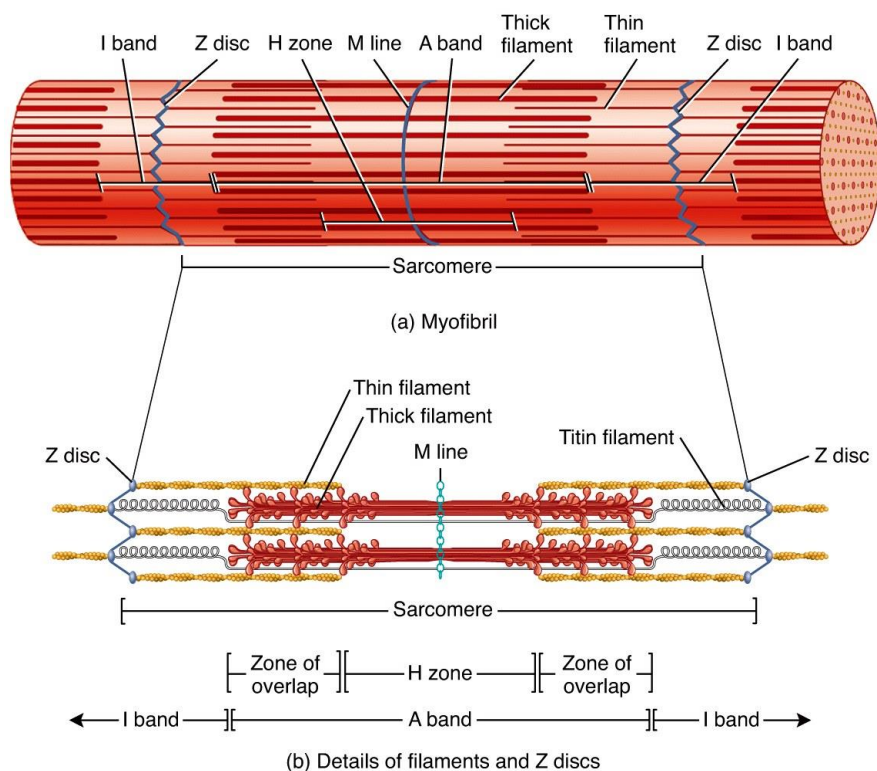

Figure 2.2. Schematic summary of the sarcomere's principal structures. Copyright © John Wiley and Sons, Inc. All rights reserved.

For the thesis, at macroscopic (behavioural) level, length of the fibres and fascicles are taken as the same, and the two terms will be used interchangeably as in other 2D B-mode ultrasonography based studies. Although a fascicle can be composed of several fibres attached end-to-end and organised side by side, functionally they would be taken as a unit.

Titin Filaments

It is now accepted that titin determines muscle elasticity (Gautel, Mues, & Young, 1999; Horowitz, 1999; Linke, 2000; Linke & Granzier, 1998; Maruyama, 1997; Trinick, 1994, 1996; Trinick & Tskhovrebova, 1999; K. Wang, 1996). Titin has many functions: (a) it provides the elasticity of the muscle by returning the myosin filament to the Z-disc after stretching, (b) restores sarcomere length, its most important function (Klee & Wiemann, 2002), (c) provides stability for the sarcomeres by keeping the myosin filaments in the centre within the sarcomere (Horowitz, 1992; Horowitz & Podolsky, 1987; Liversage, Holmes, Knight, Tskhovrebova, & Trinick, 2001), (d) may facilitate the transition of intermolecular interactions between the arrays of thick filaments (Tskhovrebova & Trinick, 2000), (e) prevents localised overstretching of the myofibril during isometric contractions, ensuring uniform sarcomere length (Goulding, Bullard, & Gautel, 1997), (f) is responsible for the sarcomere extensibility (g) plays a role in the morphogenesis of the myofibril (Fulton & Isaacs, 1991; Liversage et al., 2001; Pollack, 1990), and (h) an elastic portion of titin has an affinity for calcium ions and has binding sites which influence the contraction-relaxation cycle of skeletal muscle (Tatsumi et al., 1991).

Tendon

The triceps surae muscle group transfers force to the calcaneus via the Achilles or calcaneal tendon. At the insertion or origin point of a muscle or cartilage, the junction between the tendon and a bone, a tendon merges with the periosteum, which is the thin membrane covering the bone. At the other end (muscle-tendon junction), the tendon merges with fascia, the thin membrane covering the muscle (J. Wang, Guo, & Li, 2012). The part of the tendon which links the muscle to the bone is referred to as the free or external tendon, whereas the aponeurosis or internal tendon provides the attachment area for the muscle fibres (Magnusson, 1998; Nigg & Herzog, 2007). The primary function of a tendon is connecting a muscle to the bone by passively transmitting forces producing motion (Alter, 2004). Moreover, it decreases the risk or prevents soft tissue damage (McHugh, Connolly, Eston, & Gleim, 1999) during high-velocity action or the sudden application of external force

(J. Moore, 1992), provides a store of elastic energy (Biewener & Baudinette, 1995), and acts as a mechanical buffer to allow the muscle to work more efficiently (Biewener, 1997).

Tendons are highly organised, multi-unit hierarchical structures (Benjamin & Ralphs, 1997) that are mainly composed of crimped (wavy configuration) collagen (mainly type I) fibres aligned in one direction, making it ideal for carrying and transmitting large tensile mechanical loads (J. Wang et al., 2012), and a viscoelastic matrix of proteoglycans, glycoproteins and glycosaminoglycans (Kafka, Jírová, & Smetana, 1995). The structural unit of collagen is tropocollagen (microfibril), with five tropocollagens forming fibrils of 20-150 nm diameter that run longitudinally to its axis (O'Brien, 1997). Kannus (2000) found that the Achilles tendon fibril's diameter to be in the range of 30-130 nm (with most between 50 and 90 nm), while Magnusson et al. (2002) also reported far fewer fibrils in some parts of ruptured tendons, which is consistent with the findings of other authors (Järvinen, Järvinen, Kannus, Józsa, & Järvinen, 2004), who reported thinner collagen fibres in ruptured tendons.

Fibril is the smallest tendon structural unit consisting of largely rod-like collagen molecules aligned end-to-end in a quarter-staggered array. Fibres composed of fibrils form the next level of tendon structure. The endotenon is a thin layer of connective tissue that includes blood vessels, lymphatics, and nerves (Kastelic, Galeski, & Baer, 1978; Ochiai, Matsui, Miyaji, Merklin, & Hunter, 1979).

Several parallel fibrils form fascicles (Benjamin & Ralphs, 1997; O'Brien, 1997; Vogel, 2003), which are the smallest collagenous structure that can be mechanically tested. Endotenon binds several collagen fibres to a primary fibre bundle (sub fascicle) (Kastelic et al., 1978). Primary fibre bundles form secondary fibre bundles (fascicles) and then form tertiary fibre bundles.

Each fascicle level is again enclosed by endotenon tissue. The final structural level is the tendon unit, as the conjunction of the tertiary fibre bundles. The tendon unit is surrounded by the epitenon, a connective tissue that also provides vascular, lymphatic and nerve supply to the tendon. A third surrounding, the connective tissue layer, the paratenon, is connected with the epitenon to the peritenon. This layer

contains fluid to minimise friction between the tendon and adjacent tissues (Benjamin & Ralphs, 1997; J. Wang, 2006). The fibrils making up the tendon are all oriented parallel to the tendon axis (Elliott, 1965), allowing for an optimal mechanical load transmission (J. Wang et al., 2012) (Figure 2.3).

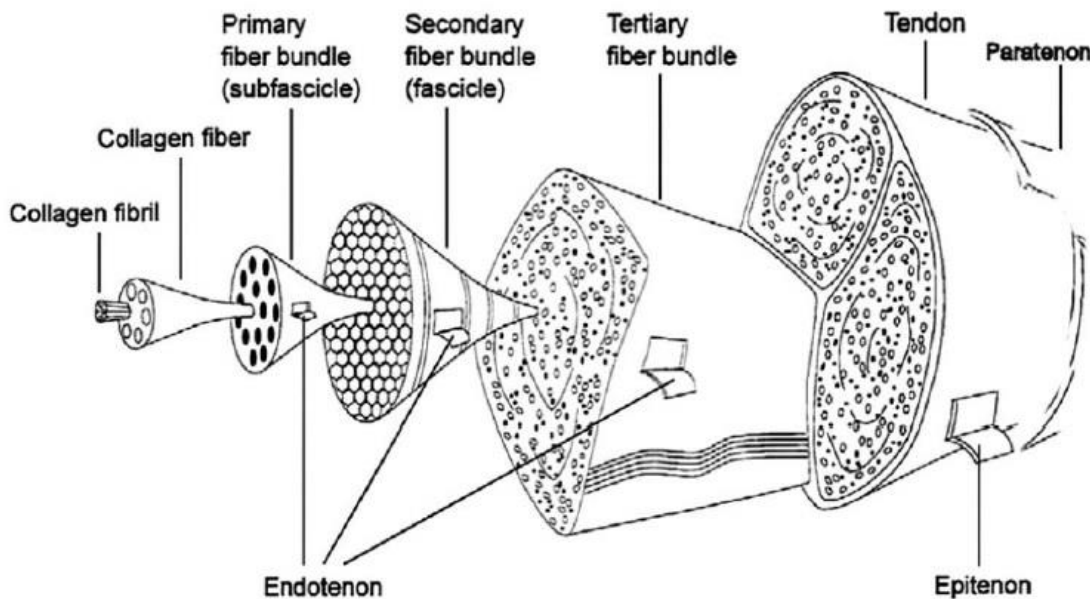

Figure 2.3. The organisation of tendon from collagen fibrils to the entire tendon. From “Structure of the tendon connective tissue” by K. Pekka, 2000, *Scandinavian Journal of Medicine & Science in Sports*, 10 (6) p.313. Copyright 2004 by John Wiley and Sons.

In an unloaded condition, the collagen fibres are ‘crimped’ - a term used to describe the sinusoidal wave-like form of the collagen fascicle (Dale, Baer, Keller, & Kohn, 1972; Diamant, Keller, Baer, Litt, & Arridge, 1972; Doroski, Brink, & Temenoff, 2007). When the tendon is stretched, the wavy configuration disappears following the straightening of the collagen fibres (Calve et al., 2004; Elliott, 1965; Józsa & Kannus, 2007) allowing tendons to elongate by ~4% (Rigby, Hirai, & Spikes, 1959), providing a buffer against mechanical stress (Hyman & Rodeo, 2000). Screen, Lee, Bader, and Shelton (2004) and Ker (2007) have suggested that the crimp is partly

responsible for the tendon's flexibility and shock absorbing capabilities. Any changes induced by tensile loading from either stretch or contractions could alter these properties and influence force production. Sliding within tendons is not limited to sliding between fascicles, but also occurs between fibrils, and this may account for up to 50% of the longitudinal deformation (i.e. strain) of a tendon (Screen et al., 2004).

The key to the tendon's tensile strength is the 'quarter-stagger' arrangement of the collagen molecules within the fibrils with fibres being bound together by the previously described covalent crosslinks between the fibres, giving the overall tendon stability and the highest tensile strength of any soft tissue (Benjamin & Ralphs, 1997; Dee, Puleo, & Bizios, 2002; Tanzer, 1973) but also contribute to the shock-absorbing capacity of tendons and maintenance of the collagen crimp pattern (Hyman & Rodeo, 2000). The higher the percentage of collagen to elastin fibres, the higher the number of fibres that are orientated in the direction of stress, and the higher the cross-sectional area or width of the tendon, the stronger the tendon (Alter, 2004).

Ker (2007) utilised the term 'multi-stranded wire' to describe the overall structure and flexibility of the tendon. This flexibility, supported by the loose binding nature between the fibrous units, is essential for the tendon to withstand great stresses in tension while retaining full movement. Tendons glide over bone, move through canals and sheaths, directing their path and ensuring movement over bone is smooth, thus eliminating friction. The synovial fluid between the two tendon sheaths improves lubrication (Lin, Cardenas, & Soslowky, 2004).

Due to the arrangement of the muscle fibres, the transition from muscle to the tendon is gradual rather than abrupt (J. Moore, 1992). The area between the muscle and tendon, the muscle-tendon junction is the area that receives the greatest stress during force transmission (Charvet, Ruggiero, & Le Guellec, 2012). At the muscle-tendon junction, the growth plate of the tendon is where elongation occurs due to the presence of cells that can elongate and deposit rapidly. Golgi tendon organs and nerve receptors are also located there to prevent over-stretching (O'Brien, 1997).

Mechanics of Muscle-Tendon Unit

The functional unit that produces motion at a joint consists of the muscle and the tendon that attaches the muscle to the bone (i.e. the muscle-tendon unit). The functional characteristics of the muscle-tendon unit are best described by a mechanical model, which is composed of four components (Figure 2.4):

- 1) The parallel elastic component: muscle membrane or fascia
- 2) The series elastic component: tendon and large structural proteins, i.e. titin
- 3) The contractile component: muscle fibre (actin and myosin)
- 4) The viscous component (McNair & Stanley, 1996).

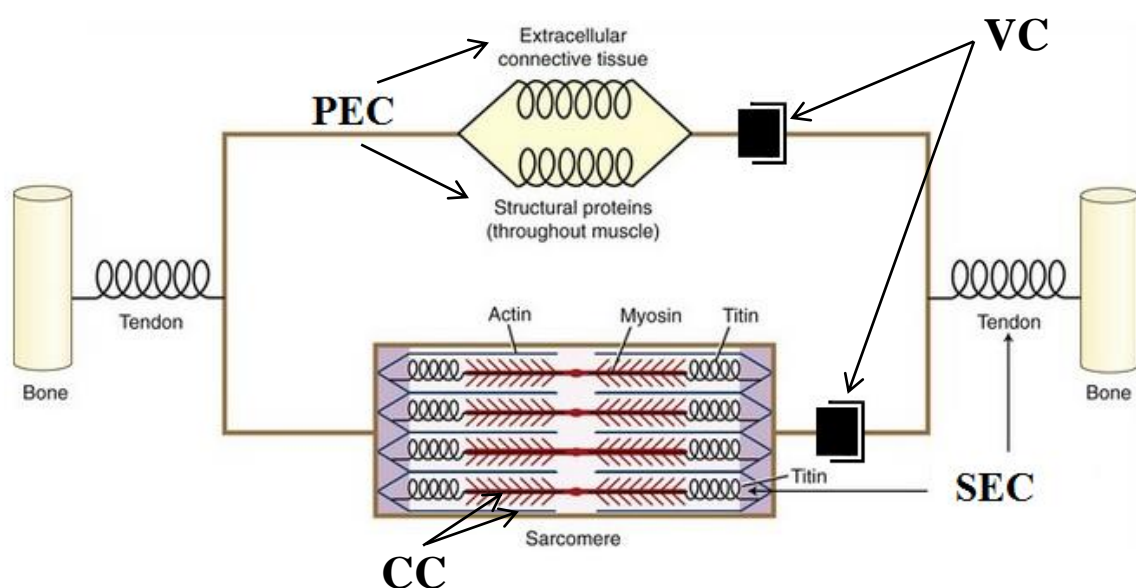

Figure 2.4. A highly diagrammatic model of the muscle-tendon unit displaying the parallel elastic component (PEC), series elastic component (SEC), contractile component (CC) and viscous component (VC). The model differentiates the non-contractile components (as coiled springs) as either series elastic component or parallel elastic component. The series elastic component (aligned in series with the contractile component) is illustrated by the tendon and the structural protein titin, shown within the sarcomere. The parallel elastic component (aligned in parallel with the contractile component) is represented by the extracellular connective tissues

(such as perimysium) and other structural proteins located throughout the muscle. Modified from "Muscle: The Primary Stabilizer and Mover of the Skeletal System," by S. Hunter and D. Brown, 2010, *Kinesiology of the Musculoskeletal System*, p.52. Copyright by Mosby and from "Effect of passive stretching and jogging on the series elastic muscle stiffness and range of motion of the ankle joint," by P. McNair and S. Stanley, 1996, *British Journal of Sports Medicine*, 30, p.313. Copyright 1996 by BMJ Publishing Group Ltd and the British Association of Sport and Exercise Medicine.

The parallel elastic component (e.g. endomysium, perimysium, epimysium) represents the elasticity of connective tissues and lies parallel to the contractile component, hence the name (Enoka, 1994). The contractile component represents the myofilament interaction between actin and myosin protein strands, which enables the shortening of the muscle tissue to produce force. The series elastic component is so named because the elastic components are directly in line with the contractile components. It represents the elasticity that lies within the tendon (passive element) and intracellular cross-bridges of actin and myosin (Walshe, Wilson, & Murphy, 1996). The damping pots represent the viscous properties and relate to the ground substance that supports the collagenous tissue (McNair & Stanley, 1996). The characteristics of each of these components dictate the force generating potential of the muscle-tendon unit, its stiffness, and response to loading. Stretching, or other interventions may modify these tissue characteristics, and performance may be affected by altering the fine dynamic balance of mechanical and neurophysiological factors changing the force production and function of the muscle (Fowles, Sale, & MacDougall, 2000).

Architectural and Mechanical Characteristics of Muscle and Tendon

Muscles and tendons vary architecturally, and this architectural difference reflects in their function. Two fundamental mechanical properties of the skeletal muscles are the force-length relationship and the force-velocity relationship.

Force-Length Relationship

The magnitude of the force produced by the muscle is related to the length at which the muscle is held (P. Edman, 2003). This observation is in agreement with the sliding filament theory. Muscle force generation capacity is dependent on the overlap between myosin and actin filaments, which consequently determine the number of myosin cross-bridges that can be formed between the filaments.

The tension-developing capacity drops off when the muscle is activated at both short and elongated lengths. At short lengths, less tension is present because the filaments have exceeded their overlapping capability, creating an incomplete activation of the cross-bridges, since less can be formed (P. Edman, 2003). When the muscle is lengthened and then activated, muscle fibre tension is initially greater because the cross-bridges are pulled apart after initially joining (Stauber, 1989). The increase in muscle fibre tension continues until the muscle length is increased slightly past the resting length. When the muscle is lengthened further and contracted, tension generated in the muscle will drop off because of the slippage of the cross bridges, resulting in fewer cross-bridges formed. At the optimal length the sarcomere length that produces the greatest force in maximally activated muscle, the contractile components are optimally producing tension, and the passive components are storing elastic energy, adding to the total tension in the unit (Gowitzke, 1984).

In the shortened muscle, the force generated is shared by the series elastic component. The tension in the muscle is equal to the tension in the series elastic component when the muscle contracts in a shortened length. As the muscle is elongated, the tension of the active components of the muscle fibres diminishes tension in the total muscle increases because of the contribution of the passive elements in the muscle. The series elastic component is stretched, and tension is developed in the tendon and the cross-bridges as they are rotated back (Huijng, 1992). Significant tension is also produced in the parallel elastic component as the connective tissue in the muscle offers resistance to the stretch. As the muscle is lengthened, passive tension is generated in these structures, such that the total tension is a combination of contractile and passive components. At extreme muscle lengths, the tension in the muscle is almost exclusively elastic or passive tension.

The force-length relationship is represented in Figure 2.5 below. The active length-tension curve is a theoretical model. The total force of the muscle is a result of the active and passive forces. Passive force is the result of the series elastic component and parallel elastic component. To derive the classical force-length relationship one must subtract passive force from the total force (Gajdosik, 2001; Lieber & Bodine-Fowler, 1993).

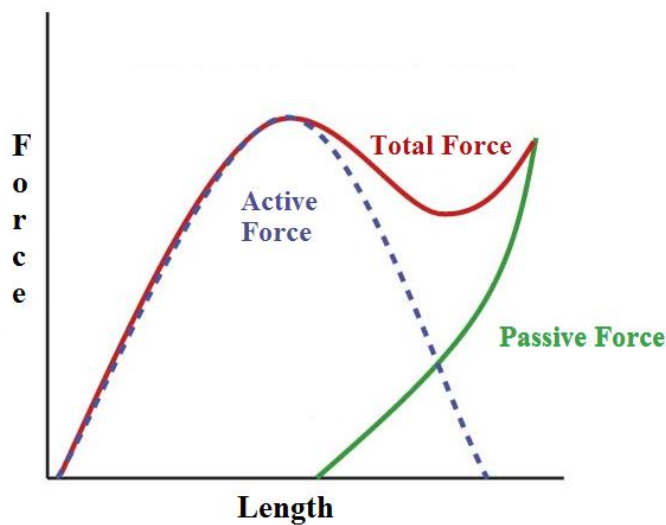

Figure 2.5. Force-Length Relationship in isolated muscle.

Force-Velocity Relationship

The force-velocity relationship means that the force generated by a muscle is a function of its velocity or in reverse, the contraction velocity depends on the force resisting the muscle. The effect of the linear velocity during muscle shortening or lengthening on the force output has been examined extensively since the pioneering work of Hill (1938). The shape of the force-velocity graph for muscle shortening is demonstrated in Figure 2.6. With a decreased linear velocity of muscle lengthening, the force generation capacity increases sharply and then plateaus with peak values around two times greater than maximal isometric force (K. Edman, 1988). Nevertheless, during voluntary lengthening contractions, such high eccentric forces may not be reached due to insufficient neural drive (Duchateau & Baudry, 2014).

With an increase in linear concentric velocity of muscle shortening, the force exerted is non-linearly decreased because the number of cross-bridges formed, and the force they exert, are reduced.

Additionally, the distribution of muscle fibre types affects the force-velocity relationship (He, Bottinelli, Pellegrino, Ferenczi, & Reggiani, 2000; Larsson & Moss, 1993). A higher force output at a faster shortening velocity indicates a higher percentage of type II fibres (Froese & Houston, 1985; Gregor, Edgerton, Perrine, Campion, & DeBus, 1979). With an increase in linear eccentric velocity of muscle lengthening, the force exerted is increased (Chapman, 1974; Thorstensson, Grimby, & Karlsson, 1976; Tihanyi, Apor, & Petrekanits, 1987; Wilkie, 1950).

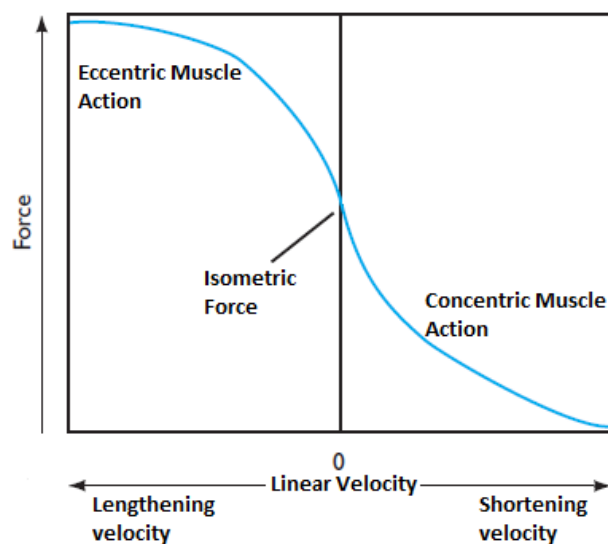

Figure 2.6. Force-velocity relationship of isolated muscle during concentric, isometric and eccentric muscle action.

Creep Deformation, Stress Relaxation, and Hysteresis

Tendons, passive muscles, as well as passive joints, possess viscoelastic properties, including velocity-dependent resistance, creep, stress relaxation and hysteresis. If a viscoelastic material is stretched and then held at a constant length, the stress, or force, at that length gradually declines; this decline is called stress relaxation (Chalmers, 2004; Frankel & Burstein, 1970; Magnusson, 1998). The

behaviour of the material is both viscous, because the tension decreases with time, and elastic because the material maintains some degree of tension (D. Taylor, Dalton, Seaber, & Garrett, 1990).

If during stretching in the elastic range, the tissue is held at a constant load, there will be a slow elongation of the tissue. This elongation is called creep deformation (Fung, 1993). Hysteresis is the difference that takes place between loading and unloading a specimen in the stress-strain cycle (Fung, 1993). For viscoelastic materials, greater energy is absorbed during loading than is dissipated during unloading (Kubo, Kanehisa, Kawakami, & Fukunaga, 2001b). Thus, the energy returned is not equal to the energy stored and is lost (Figure 2.7). Hysteresis is typically expressed as a percentage, and calculated as the area (energy) between the loading and unloading curves relative to the area under the loading curve (Maganaris, Narici, & Maffulli, 2008). Hysteresis values ranging from 3 to 38% have been reported *in vivo* for the Achilles tendon (Finni, Peltonen, Stenroth, & Cronin, 2013). The amount of hysteresis may be lower in high stressed tendons that have a role in energy storage and release compared to low stressed tendons of positional muscles (Shadwick, 1990). For example, in Achilles tendon the elastic properties have been shown to prevail over viscous properties *in vivo*, giving rise to a relatively low hysteresis (Peltonen, Cronin, Stenroth, Finni, & Avela, 2013). Viscoelastic materials also display the property of strain rate dependence. Strain rate-dependent materials exhibit higher tensile stresses at faster strain rates. Strain rate dependence occurs because slower strains allow for greater relaxation to occur within the tested material. (D. Taylor et al., 1990).

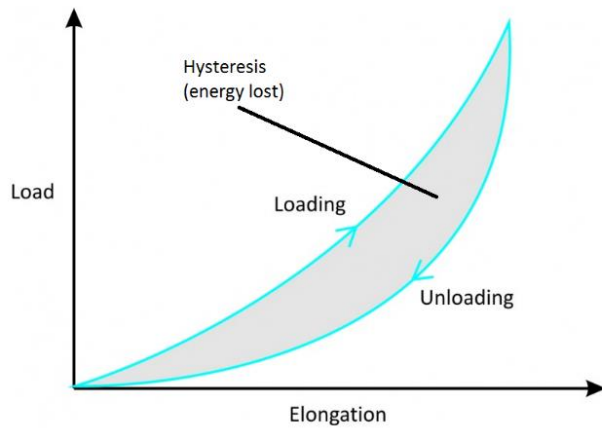

Figure 2.7. Hysteresis. Typical loading (top) and unloading curves (bottom). The two non-linear curves form the hysteresis loop. The area of the hysteresis loop is representative of the energy losses within the tissue.

Stiffness

In dynamic flexibility, an important measurement is stiffness, a mechanical term defined as the resistance of a structure to deformation (Litsky & Spector, 1994). Stiffness is defined as the gradient of the force-elongation ($\Delta F/\Delta L$) curve of a material (Figure 2.8). A greater increase in force (F) is in response to a given amount of stretch (L), which indicates a greater stiffness. It can also be assessed by calculating the slope of passive moment or torque-angle curve, and it is usually measured at a slow constant rate of applied dynamic stretch in order to avoid stretch-reflex activations. According to Gajdosik, (2001), the opposite of stiffness is compliance, that is the ratio of the change in length in response to a change in imposed force ($\Delta L/\Delta F$). Thus, if stiffness has decreased after a stretching a session, compliance has increased.

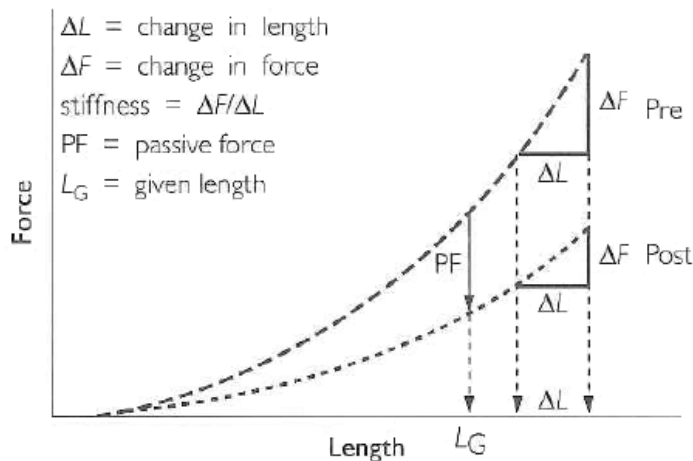

Figure 2.8. Passive force and stiffness of the muscle-tendon unit. After a stretching session, the passive force (PF) at a given muscle length (L_G) may decrease. The muscle-tendon unit stiffness, the increase in resistive force to an imposed increase in length ($\Delta F/\Delta L$), is reduced. From “Stretching and Flexibility” by D. MacDougall and D. Sale, 2014. *The physiology of training for high performance*, p.325. Copyright 2014 by James Duncan MacDougall & Graham Digby Sale.

Recently, due to advances in imaging technologies, it has been shown that shear elastic modulus measured using shear wave elastography (Bercoff, Tanter, & Fink, 2004) is linearly related to passive muscle tension during stretching (Koo, Guo, Cohen, & Parker, 2013; Maïsetti, Hug, Bouillard, & Nordez, 2012) and to muscle force during isometric contractions (Ateş et al., 2015; Bouillard, Hug, Guével, & Nordez, 2012; Bouillard, Nordez, & Hug, 2011), providing a non-invasive estimation *in vivo* changes in passive muscle stretching or contractions. This technique provides a quick measurement of the muscle shear modulus by analysing propagation velocity of induced shear waves in a region of interest within soft tissue in real time. On-site immediate assessment of the stiffness is possible in a defined area in a muscle belly or tendon using a standard ultrasonic probe (Gennisson et al., 2010). When performed under well-controlled conditions that ensure reproducibility, shear wave elastography has been shown to be a reliable technique for investigating muscle biomechanical properties (Akagi & Takahashi, 2014; Dubois et al., 2015; Gennisson et al., 2010; Koo, Guo, Cohen, & Parker, 2014; Kot, Zhang, Lee, Leung,

& Fu, 2012; Lacourpaille, Hug, Bouillard, Hogrel, & Nordez, 2012; Maisetti et al., 2012) and as it does not require external manual compression applied by the operator, it has the advantage of providing also more objective outcomes (Correas et al., 2014).

Briefly, shear waves are generated in the tissue by focusing ultrasound pushing beams at different depths; then, by using high-frame rate imaging (up to 20,000 images/s), a movie of the shear wave propagating is recorded. B-mode images and shear wave speed movies are acquired. The shear wave speed is retrieved from a time of flight algorithm over the acquired movie. Assuming a linear elastic behaviour (Bercoff et al., 2004), the muscle shear elastic modulus (μ) is calculated as follows (Gennisson, Catheline, Chaffai, & Fink, 2003; Gennisson, Cornu, Catheline, Fink, & Portero, 2005):

$$\mu = \rho V_s^2$$

where ρ is the density of soft tissues (1,000 kg/m³) and V_s is the shear wave speed.

Muscle is highly anisotropic (Gennisson et al., 2010), thus acquisitions are performed with the probe in the plane parallel to the muscle fibres and perpendicular to the skin; this position is determined when several fibres are continuously visible on the B-mode image. The preceding relationship is valid in tissues that are infinite (or large in extent), isotropic, homogenous, linear and elastic (Sarvazyan, Urban, & Greenleaf, 2013). Since muscles do not have these characteristics, this “stiffness” is reported in terms of shear wave speed (m/s) which requires few assumptions about the tissue geometry and mechanical coupling of tissue regions when measured at comparable joint angle or contraction state. The estimation of elastic modulus is based on the assumption that shear wave speed increases in tissues of higher stiffness and vice versa (Bercoff et al., 2004).

Stress, Strain and Young's Modulus

The mechanical properties of muscle and tendon are used to describe their behaviour under loading conditions. Properties commonly reported include:

- strain (ϵ), which is the elongation of a tissue calculated as a percentage of its original length; $\epsilon = \Delta L/L_0$
- stress (σ) is calculated by dividing tensile force by cross-sectional area (CSA); $\sigma = F/CSA$
- Young's modulus (E) is a measure of a material's stress-strain relationship – stiffness of the material relative to its dimensions.

Pennation Angle and Fascicle Length

One of the most important parameters of muscle architecture is the pennation angle. The pennation angle is defined as the angle between the orientation of a fascicle and the attached tendon axis (i.e., the line of action) which influence muscle performance (Kurihara et al., 2005; Lieber & Fridén, 2000; Rana, Hamarneh, & Wakeling, 2009). Changes in pennation angle are important for calculating/estimating the individual muscle force or joint moments based on the direction of its fibres (Maganaris, Baltzopoulos, & Sargeant, 1998). In these theoretical models, muscle thickness (the distance between aponeuroses) remains invariant when the muscle fibre increases or decreases in length (Kawakami et al., 1994; Narici et al., 1996). Nevertheless, other authors (Herbert & Gandevia, 1995; Ichinose, Kawakami, & Fukunaga, 1995) found out that muscle thickness may change during muscle contractions. According to Maganaris and Baltzopoulos (1999), in a bipennate muscle like tibialis anterior (TA) during maximal voluntary contraction, the pennation angles decreases and fascicle length decreases with an invariant thickness from dorsiflexion to plantarflexion changing the force generating capacity of the muscle (Gans, 1982). Reeves and Narici (2003) found out that at all ankle angles of TA muscle during concentric and isometric contractions the pennation angles were significantly larger than during the resting state and the fascicle length was larger in the isometric than the resting state. In pennate muscles, the peak force generated was higher than parallel fibre muscles (Gans,

1982). Maganaris et al. (1998) investigated the effects of the pennation angle and the fascicle length of the triceps surae muscle group at different ankle lengths at rest and in isometric contraction sites. The pennation angle increased whereas the length of fascicles decreased from rest to a maximal voluntary isometric contraction (MVIC) plantarflexion intensity for MG, lateral gastrocnemius, and soleus (SOL). The thickness of the MG and the SOL muscle remained unchanged while for the SOL increased from the resting to the contraction state.

Force Production Capacity of the Muscle-Tendon Unit is Affected by Structural and Mechanical Properties of the Muscle and Tendon

Voluntary muscular force production is a multifaceted hierarchical process. Huxley and Niedergerke (1954) and Huxley and Hanson (1954) proposed the basis for understanding muscle contraction, the sliding filament theory (Figure 2.2). It should be noted that any disruption of the hierarchical process could lead to the disruption of the force development mechanism.

Contraction of a skeletal muscle fibre is directed by a message (nerve impulse) from the central nervous system that travels within a motor neuron located within a peripheral nerve, the neural impulse travels along the spinal cord and the peripheral nerves and arrives at the neuromuscular junction. At that point the neurotransmitter acetylcholine (ACh) is released, diffusing into the synaptic cleft of the neuromuscular junction by exocytosis. ACh then binds to receptors on the motor end plate of the sarcolemma of the muscle fibre, activating sodium gates on the sarcolemma. This causes depolarisation of the motor end plate. ACh travels throughout the muscle by the transverse tubules, causing calcium (Ca^{2+}) to be released from the sarcoplasmic reticulum. Ca^{2+} passes down into the sarcoplasm to bind to troponin changing its shape and moving tropomyosin from the active site of the actin enabling actin-myosin cross-bridge interaction to produce force (H. Huxley, 1967).

The whole muscle contraction process needs energy. The breakdown of adenosine triphosphate (ATP) releases energy which causes the sarcomeres to shorten by sliding the myofilaments (binding myosin to actin) past each other, pulling

the Z-discs closer together forming cross-bridges (Hoppeler & Billeter, 2003). This process of muscular contraction can last for as long as there are adequate ATP and Ca^{2+} stores. Once the impulse stops, the Ca^{2+} is pumped back to the sarcoplasmic reticulum and actin returns to its resting position causing the muscle to relax (Brenner & Eisenberg, 1987).

One factor affecting active force production during a given level of muscle activation is the degree of myofilament overlap, as this determines cross-bridge availability (MacIntosh, Gardiner, & McComas, 2006). This is demonstrated by the force-length relationship. At longer sarcomere lengths, cross-bridge interaction is decreased as a result of less overlap between actin and myosin filaments (K. Edman, Grieve, & Nilsson, 1966; Gordon, Huxley, & Julian, 1966; Lieber, Loren, & Fridén, 1994) and the force output is small. As the sarcomere shortens, greater overlap occurs, and subsequently, more force is produced until optimal overlap is reached.

Force production is impaired when further shortening of the sarcomere below the optimal length due to the overlap of the actin filaments from opposite ends of the sarcomere and the compression of the myosin filament as it comes in contact with the Z-disk (Lieber, 2010). Also, calcium sensitivity of the contractile apparatus is diminished with reduced muscle length (Iaizzo & Poppele, 1990), which would slow the excitation-contraction coupling process. Therefore, it is evident that the muscle length operating range during contraction, and the subsequent level of cross-bridge interaction between actin and myosin, may influence the magnitude of force production (Brughelli & Cronin, 2007).

Importantly, the plantarflexors tend to operate on the ascending limb of their force-length curve during most normal movements (Maganaris, 2001, 2003), so stretching a sarcomere beyond the optimal length can also reduce the force production capacity due to the disruption of the transfer of muscular force to the tendon.

The contractile force generated by the muscle is transmitted to the skeletal system to produce joint moments. Thus, the properties of the tendon will partly dictate the force transmission. Tendons are viscoelastic materials, and as such, they

respond to the loads imposed upon them. Differences in tendon slack have been shown to alter the time course of force development (Muraoka, Muramatsu, Kukunaga, & Kanehisa, 2004), with stiff tendons transmitting force with minimal delay (Bojsen-Moller, Magnusson, Rasmussen, Kjaer, & Aagaard, 2005). Studies have shown decrements in peak twitch force after stretching (Behm et al., 2001; Fowles et al., 2000), suggesting the series elasticity was altered. If a tendon becomes more compliant, it will have to elongate more prior to the transmission of force to the skeletal system. During maximum effort, this increased shortening requirement will ultimately determine the muscles position on the force-length curve.

Mechanisms of Stretching

In this section, proposed mechanisms for the effect of stretching on muscle and tendon properties are discussed. Specifically, there are three opposing models introduced, which are sensory, neurological and mechanical.

Muscle Mechanical Changes

At rest (i.e. when the muscle is not contracted), the behaviour of the muscle-tendon unit depends on its passive properties (Özkaya & Nordin, 1999). The increase in the muscle-tendon unit length after the application of external load is due to its viscoelastic properties (Magnusson, Simonsen, Aagaard, Dyhre-Poulsen, et al., 1996; Özkaya & Nordin, 1999).

(Static) stretching amends the mechanical characteristics of the muscle, retaining these changes for a short period after the cessation of stretching (Magnusson, Simonsen, Aagaard, Dyhre-Poulsen, et al., 1996). If stretching is continuous, or if there is not enough time for the muscle to recover before the next stretching session, the muscle-tendon unit does not return back to its original position, and it deforms, remaining elongated temporarily (creep deformation) (Enoka, 2015). The relationship between length and stress (standardised/normalised force) is traditionally expressed using the length-force

relationship of the muscle-tendon unit. When alteration in muscle length is measured in people, this length-force relationship is assessed indirectly, by measuring the ROM around the joint over which the muscle-tendon unit of interest spans and torque experienced about the joint. Consequently, the length-force relationship is expressed as its equivalent in terms of an angle-torque relationship (Enoka, 2015).

Static stretching may affect the mechanical properties of the muscle altering the optimal surface of transversal bridges of the action and myosin cross bridges and subsequently, the length-tension relationship of the sarcomere and force production at the muscles (Behm, Blazevich, Kay, & McHugh, 2015). The increase in ROM after acute muscle stretching may be attributed to changes in mechanical properties of the muscle-tendon unit (Guissard & Duchateau, 2006; Law et al., 2009; Magnusson, Simonsen, Aagaard, Dyhre-Poulsen, et al., 1996; Toft, Sinkjær, Kålund, & Espersen, 1989; Weir, Tingley, & Elder, 2005). When forcibly lengthened, muscle-tendon unit extends and recovers its initial length when the force is released. However, due to their viscoelasticity, these tissues become transiently less stiff after passive stretching (Halbertsma, Van Bolhuis, & Göeken, 1996; Kato, Kanehisa, Fukunaga, & Kawakami, 2010; Magnusson, Simonsen, Aagaard, Dyhre-Poulsen, et al., 1996; Safran, Seaber, & Garrett, 1989; D. Taylor et al., 1990). Since pre-exercise stretching decreases muscle-tendon unit stiffness the force generated by the contractile component is transmitted to the skeletal system less effectively than by a stiffer unit (G. Wilson, Murphy, & Pryor, 1994). A more compliant unit acutely decreases force production due to altered muscular length and velocity conditions (G. Wilson et al., 1994). A decrease in muscle stiffness (Kay et al., 2016; Kay & Blazevich, 2009; Morse et al., 2008; Weppeler & Magnusson, 2010) probably due to longer muscle fascicles (Blazevich, Cannavan, Horne, Coleman, & Aagaard, 2009; Blazevich, Horne, Cannavan, Coleman, & Aagaard, 2008) causes the muscle to require more time to go from slack to taut, at the onset of a muscle contraction decreasing rate of force development but also leading to alteration in the force-length relationship (Cramer et al., 2004).

Influence of Stretching on Muscle Architecture

Muscle contraction generates forces, which contribute to the joint moments. Muscle force depends on the length, pennation angle, the velocity of contraction, activation level, fibres types, and previous activation level of the muscle (Baltzopoulos & Maganaris, 2009). Mechanical properties of the tendon will affect functional muscle length and velocity of contraction, in addition to the rate of force transmitted to the muscle, and hence can affect muscle force output. Therefore, it is important to investigate the effects of stretching on both architectural and mechanical properties of the muscles and tendon, their interactions and overall impact on function (Baltzopoulos & Maganaris, 2009).

According to Baltzopoulos and Maganaris (2009) the architecture of a skeletal muscle is defined as the spatial arrangement of muscle fibers with respect to the axis of force generation in the muscle-tendon unit affecting conversion of the force and excursion of the muscle fibers into joint actions (Fukunaga, Ichinose, Ito, Kawakami, & Fukashiro, 1997). Understanding the spatial arrangement of muscle fibres is essential when studying muscle functions and the resultant joint functions (Fukunaga, Ichinose, et al., 1997). It is well known that a significant variation exists in the muscle architecture concerning fibre length, pennation angle, cross-sectional area, and muscle volume within and between individuals. In general, in muscles with short fibres, fibres are packed with an angle into the muscles to increase its physiological cross-sectional area. Therefore the muscle can produce more force and use the elastic tendon for energy storage and release providing more efficient muscle tendon movement (Fayed, 2010). Depending on muscle architecture, smaller volume muscles with short fibres can generate relatively higher force than high volume muscle with long fibres which are more suitable for speed (Fayed, 2010).

From this, it becomes evident that the pennation angle affects muscle fibre length; i.e., for a given muscle volume or area, the larger the pennation angle, the shorter the muscle fibre length relative to the whole muscle belly length (Baltzopoulos & Maganaris, 2009). As muscle fibre length is determined by the number of serial sarcomeres in the muscle fibre, the above relationship means that

increasing pennation angle penalises the speed of muscle fibre shortening and the excursion range of fibres (Baltzopoulos & Maganaris, 2009).

The architectural properties of skeletal muscles affect the muscular contraction properties. Therefore, adaptation to different training programs should be adjusted to cause the muscle-specific changes required by the individual person or athlete (Alegre, Jiménez, Gonzalo-Orden, Martín-Acero, & Aguado, 2006). For example, differences in the fibre/fascicle length and pennation angle are associated with differences in the shortening velocity of muscles (Wickiewicz, Roy, Powell, Perrine, & Edgerton, 1984).

Traditionally, the architectural properties of skeletal muscles have been studied using cadaveric tissue, because of difficulties associated with measuring *in vivo* muscles (Cutts, 1988; Wickiewicz, Roy, Powell, & Edgerton, 1983). More recently, muscle architecture has been studied *in vivo* using various muscle-imaging techniques; i.e. magnetic resonance imaging (MRI) and ultrasound, allowing a direct measurement of the architectural parameters (fascicle length, pennation angle and muscle tendon junction displacement) *in vivo* human muscles (Henriksson-Larsen, Wretling, Lorentzon, & Öberg, 1992; Rutherford & Jones, 1992). This technique is validated through comparisons with direct anatomical measurements of muscle fascicle lengths and pennation angles on human cadaveric muscles (Kawakami, Abe, & Fukunaga, 1993; Narici et al., 1996). To accurately measure the length of short fascicles, which are completely visible in ultrasound imaging, a digitising software can directly be used. For long fascicles multiple scans along the muscle length are required to be fitted together (Kawakami, Ichinose, & Fukunaga, 1998), or linear extrapolations to be performed to estimate the length of the fascicle that cannot be imaged directly due to the limitation of the small probe in static ultrasonography (Kay & Blazeovich, 2009; Reeves & Narici, 2003).

Influence of stretch training on muscle architecture has extensively been studied and reported in the literature (Aagaard et al., 2001; Alegre et al., 2006; Blazeovich, Gill, Bronks, & Newton, 2003; Blazeovich & Giorgi, 2001; Kanehisa et al., 2002; Kawakami, Abe, Kuno, & Fukunaga, 1995; Morse et al., 2008; Rutherford & Jones, 1992; Samukawa, Hattori, Sugama, & Takeda, 2011). An increase in fascicle pliability and length has been reported after acute static (passive) stretching (Morse

et al., 2008). When the fascicle is lengthened, the muscle fibres will also be lengthened. According to the length-tension relationship of the sliding filament theory, there should be an optimal length at which muscle fibres contract with the greatest force. Depending upon the muscle fibre length, the joint angle and the amount of stretch it experiences, force producing capacity of the muscle will be different. If stretching is associated with alteration in the length of the muscle fibre/fascicle, the optimal length of the muscle will be altered (Rassier, MacIntosh, & Herzog, 1999).

The alteration of pennation angle is another possible explanation for changes in the force producing capacity of the muscle following stretching (Kubo et al., 2001b; Morse et al., 2008). Theoretically, the lower the pennation angle, the more force is transferred from each fibre to the line of action or deep aponeurosis. When a pennate muscle is stretched, depending which structures of the muscle-tendon unit architecture are most affected, there could be residual changes in its pennation angle; which in turn will change the muscle's ability to transfer force to its line of action. If stretching induces significant alterations in tendon viscoelastic properties or deforms the tendon, there may be a resulting increase in the pennation angle of its accompanying muscle. This increase in pennation angle would be a result of the increase in the viscoelastic nature of the tendon (Maruyama, Murakami, & Ohashi, 1977). Thus, should the tendon become lengthened, or more pliable, muscle fibres will 'take up the slack', this will result in an increase in pennation angle and a potentially associated decrease in its force producing capacity.

On the contrary, should the muscle fibres be more affected by stretching than the tendon, then, the result would be a decrease in the pennation angle, as the increase in pliability secondary to stretching may induce increased laxity of the muscle fibre. If the sarcomeres of muscle fibre become more lengthened whilst there are no changes in tendon viscoelasticity, then, the result should be a decrease in pennation angle (Tilp, Steib, Schappacher-Tilp, & Herzog, 2011). Previous studies have shown that pennation angle is reduced during stretching, suggesting that a persisting pennation angle change with stretching may be possible (Kubo et al., 2001b). The observed increase in pennation angle reported by Morse et al. (2008) was found while the muscle was contracting, so a persistent alteration

secondary to stretching in non-contracted muscle may differ from those associated with contracting muscles.

In contrast to the above studies, Samukawa et al. (2011) found that the pennation angle and fascicle length remained unaffected after an acute dynamic stretching protocol of the plantarflexors, where increased ankle flexibility was explained by lengthening of the tendon tissues. Additionally, Kato, Vieillevoye, Balestra, Guissard, and Duchateau (2011) and Nakamura, Ikezoe, and Takeno (2011) reported no changes in fascicle length and pennation angle after five repetitions of 1 min static stretching. The authors suggested that the increase in flexibility may be due to the movement of the aponeuroses and connective tissue (endo-, peri-, and epimysium) instead of a lengthening of muscle fibres.

A fibre with a large pennation angle operates closer to its optimum length and based on the length-tension relationship, can generate greater force (Muhl, 1982). These factors act to increase maximal isometric force and, therefore, pennation angle influence the maximal power output generated by a muscle. Nevertheless, greater pennation angles are also associated with slower contraction velocities and by increasing the pennation angle it may negatively impact maximum shortening velocity (Spector, Gardiner, Zernicke, Roy, & Edgerton, 1980). Despite this, the increase in maximum isometric force is theorised to have a substantially greater impact on maximal power than increases to maximum shortening velocity brought about through an increase in pennation angle (MacIntosh, Neptune, & Horton, 2000).

Passive and Active Loading on Tendon

Taylor, Dalton, Seaber, and Garrett (1990) investigated the viscoelastic properties of rabbit extensor digitorum longus and TA muscle-tendon units. Their experiment attempted to simulate cyclic stretching and static stretching. The study demonstrated that 80% of the total change in length was accomplished in the first four stretches when ten repeated stretches were applied at the same level of tension. Based on this, little benefit may be expected after four stretches; however, this study was done in animals, so caution must be taken when extrapolating this data to humans.

Kubo, Kanehisa, and Fukunaga (2002b) have demonstrated that repeated static stretching and isometric contractions made the human tendon structures decrease stiffness, indicating an increase in elongation of the tendon structures. One possible explanation is that the increase in temperature may alter the viscoelastic properties of the intramuscular connective tissue. After 5 minutes of static stretching, stiffness decreased by 8% and hysteresis by 29%. In another study, stiffness and hysteresis decreased significantly 9% and 34% after static stretching for 10 minutes (Kubo et al., 2001b). These two studies demonstrate that stretching makes tendon more compliant. Kubo et al. (2002b) speculated that stretch training increased flexibility but not the elasticity of tendon structures, but it somewhat affected the viscosity of tendon structures and significantly decreased the hysteresis.

Stretching of Other Structures – Fascia

Ligaments and other dense fibrous connective tissues are prone to creep and relaxation in response to continuous mechanical loading (Schleip et al., 2012). Fascia is a complex structure, generally composed of at least two membranous layers of collagen tissue (Benetazzo et al., 2011). The dense fibrous state of the fascia allows it to interconnect muscles, bones and organs in a matrix-like manner throughout the entire body (Chaudhry et al., 2008). The superficial and deep fascia are the main layers of the fascia described by anatomists as two separable parts of the fascial system (Benjamin, 2009). Superficial fascia is defined as an “enveloping layer directly beneath the skin containing dense and areolar connective tissue and fat” while deep fascia is described as “a continuous sheath of mostly dense tissue, irregularly arranged connective tissue that limits the changes in the shape of the underlying tissues”(Langevin & Huijing, 2008). Fascia is observed throughout the body, and it varies in density and thickness in relation to the area of the body, the gender and the body surface (Stecco, Macchi, Porzionato, Duparc, & De Caro, 2011).

Different stretching modalities affect different fascial tissue components. According to Schleip et al. (2012), during the “classic” stretching the myofibres are

relaxed, and the muscle is elongated. Fascial tissues parallel to the myofibers (intramuscular), as well as extramuscular connection are being stretched. Fascial tissues oriented in series with the myofibers are not sufficiently loaded since most of the elongation in that serially arranged force is taken by the relaxed myofibers (Schleip et al., 2012). This is because the relaxed myofibers are much softer than their serially arranged tendinous extensions; thus they 'swallow' most of the elongation (Jami, 1992). However, during actively loaded stretching, the muscle is active and loaded at long end range. Most of the longest myofascial chains are being stretched and stimulated in that loading pattern (Myers, 1997).

In contrast to the prior assumptions, recent evidence shows the existence of myofascial chains that build an extensive tensegrity network linking the skeletal muscles of the human body (Myers, 2014; Wilke, Krause, Vogt, & Banzer, 2016). This body-wide myofascial continuity holds particular significance because fascial tissues are able to change their tensional state. Another theory suggests that muscle contraction directly stretches the overlying fascia, in this manner adjusting connective tissue stiffness (Findley, Chaudhry, & Dhar, 2015). Regardless of mechanisms, the capability of fascia to modify its mechanical properties has the potential implications for therapy and training. If tension can be increased and decreased in response to individual modalities, it might be transmitted along myofascial intermuscular connection to adjacent structures. There is good evidence for the existence of three myofascial structures (the superficial backline (SBL: plantar fascia, gastrocnemius, hamstrings, erector spinae); the back functional line (BFL: latissimus dorsi, contralateral gluteus maximus, vastus lateralis); and the front functional line (FFL: adductor longus, contralateral rectus abdominis, pectoralis major)) through which tension can be transferred to the adjacent muscles (Wilke et al., 2016). This challenges the traditional view and encourages targeting the entire myofascial chains in the implementation of the stretching intervention.

Neuro-physiological Mechanisms

Stretching techniques are also based on neurophysiological factors that involve the myotatic, or "stretch" reflex and the inverse myotatic "stretch" reflex on

top of the mechanical changes. The myotatic reflex involves activity in the feeling receptors, found in the intrafusal muscle spindle fibres (Figure 2.9). The intrafusal fibres lie parallel to the extrafusal fibres (those containing myofibrils) and connecting to the tendons. The endings of the intrafusal muscle fibres are innervated by γ -centrifugal fibres (γ -motor efferent neurons).

Muscle spindles have both sensory and motor innervations. In the centre of the muscle spindle, there are the primary sensory fibres that react to changes in muscle length plus rate of change of length under conditions of a static position as well as passive and active movement (Ia afferent fibres) (Kandel, Schwartz, & Jessell, 2000), whereas the smaller diameter secondary sensory fibres lie parallel to the primary sensory endings that measure only tonic length (II afferent fibres) (Gandevia, McCloskey, & Burke, 1992). Spindles continuously send this information to the central nervous system through type Ia and II sensory axons, that have many targets (Chalmers, 2004). Stretch of a muscle increases the action potential discharge rate from the spindles, and if the spindle activity is sufficient, activation of the motor neurons results and a contractile force is generated in the stretched muscles (Kandel et al., 2000). If pre-existing activation level of the target muscles and cognitive state of the subject are kept constant, the amplitude of the stretch response will increase with greater lengths and/or speeds of muscle stretch, because these larger stimuli increase the frequency of Ia action potentials and the number of Ia sensory axons activated (De-Doncker, Picquet, Petit, & Falempin, 2003; Houk, 1991; Kearney, Lortie, & Stein, 1999; Meunier & Pierrot-Deseilligny, 1989; Rossi-Durand, 2002).

The information coming into the spinal cord via the Type I sensory neuron is also sent to the cerebellum and cerebral sensory areas to be used as feedback on muscle length and velocity (Hamill, Knutzen, & Derrick, 2015). Additional connections are made in the spinal cord with inhibitory interneurons, creating a reciprocal inhibition, or relaxation/a depression of the stretch reflex response of the antagonistic muscles (Hultborn, Jankowska, & Lindström, 1971).

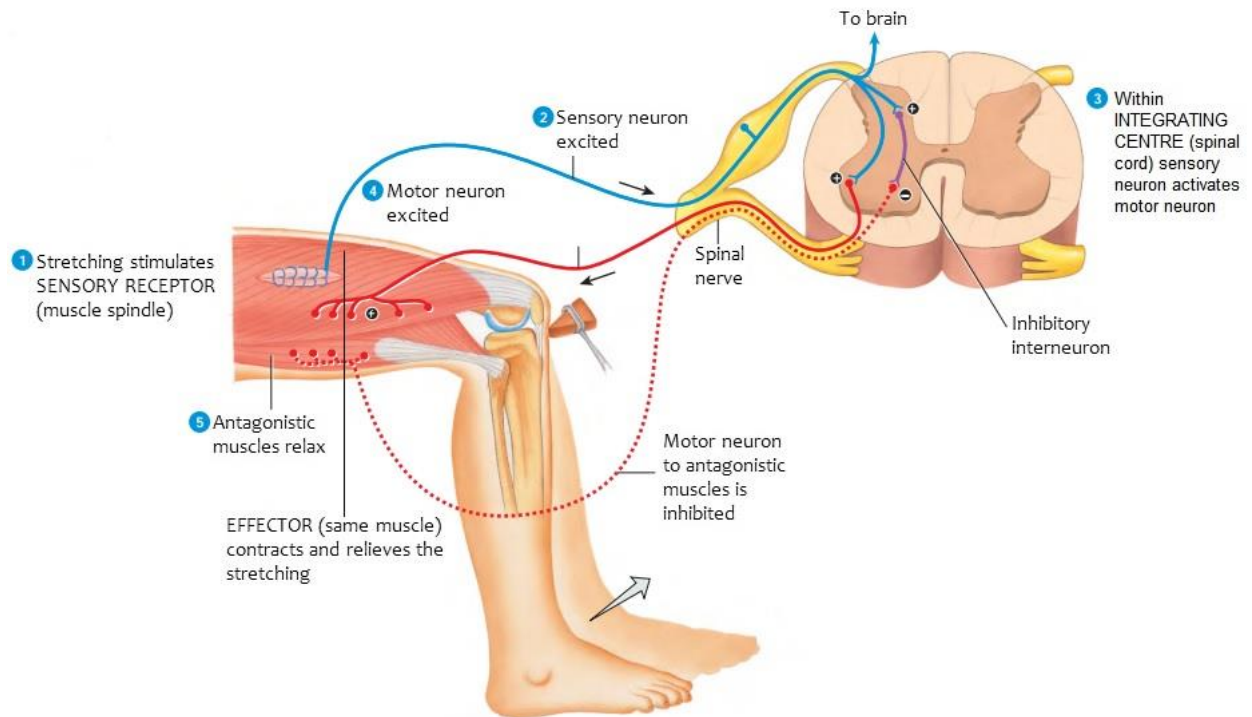

Figure 2.9. Illustration of the Stretch Reflex (autogenic facilitation) and reciprocal inhibition. From “The spinal cord and spinal nerves,” by G.J. Tortora and B. Derrickson, 2014, principles of anatomy and physiology, p.464. Copyright 2014 by Gerard J. Tortora, L.L.C., Bryan Derrickson, John Wiley & Sons, Inc.

The Golgi tendon organ is another sensory receptor located almost exclusively to the aponeuroses or muscle tendon junctions. It responds to changes in muscle tension and is located at the muscle tendon junction. Each Golgi tendon organ is connected in series with small bundles of extrafusal muscle fibres (10-15) (J. Smith, 1976). The sensory information detected by the Golgi tendon organs when collagen fascicles are compressed through stretch or contraction, the type Ib sensory afferent nerve endings is conveyed to the dorsal column.

Unlike the nerve impulses from muscle spindles, the nerve impulses from Golgi tendon organs cause relaxation of the muscle (inverse myotatic reflex) (Figure 2.10). This reflex relaxation serves as a protective mechanism from the increased tension in the muscle and allows the muscle to increase its length through its relaxation (Enoka, 2015). In other words, the neuromuscular reflexes adapt to the

continuous tension and alter the ability of the muscle to relax, in order to protect it. By knowing the function of these reflexes, we can increase the degree of relaxation of the muscle and achieve greater stretching (R. Nelson & Bandy, 2004, 2005). The role of the myotatic reflex during stretching depends on the type of stretching implemented to a large extent. Nelson, Allen, Cornwell, and Kokkonen (2001) reported that the myotatic reflex was triggered in both rapid and sudden increases in muscle length, as in ballistic stretching- and in slow and controlled movements as in SS and proprioceptive neuromuscular facilitation.

Whether a stretch reflex is evoked in a nominally fast stretch depends on the definition of "fast". In the gastrocnemius muscle a stretch corresponding to an ankle joint angular velocity of 25 deg/s did not evoke a stretch reflex (the EMG was silent) but the reflex (indicated by the EMG, that added active force to the passive force produced by the slow stretch) was evoked at a velocity of approximately 70 deg/s opposing the stretch (Nicol & Komi, 1998). However, stretching of the knee at extension velocities of 5 and 20 deg/s did not evoke any stretch reflexes (Magnusson, 1998) indicating that different joints have different velocity thresholds for evoking the stretch reflex, and threshold velocity may vary for different muscles.

A significant number of studies indicated that, after stretching, the decrease in performance was associated with decreased muscle activation (Avela, Kyröläinen, & Komi, 1999; Babault, Kouassi, & Desbrosses, 2010; Cramer et al., 2007; Fowles et al., 2000). However, these findings are contradictory. In other studies, no changes were found in the electrical activity of the muscle (Cornwell, Nelson, & Sidaway, 2002; Herda et al., 2008; Hough, Ross, & Howatson, 2009) following a decrease in performance. Nevertheless, the most successful techniques to improve ROM (such as proprioceptive neuromuscular facilitation) were associated with increased electromyographic activity (Magnusson, Simonsen, Aagaard, Dyhre-Poulsen, et al., 1996). Thus, the increase in ROM at a joint cannot be attributed entirely to neuromuscular relaxation (Costa et al., 2010; Magnusson et al., 1996; Reid & Mcnair, 2004).

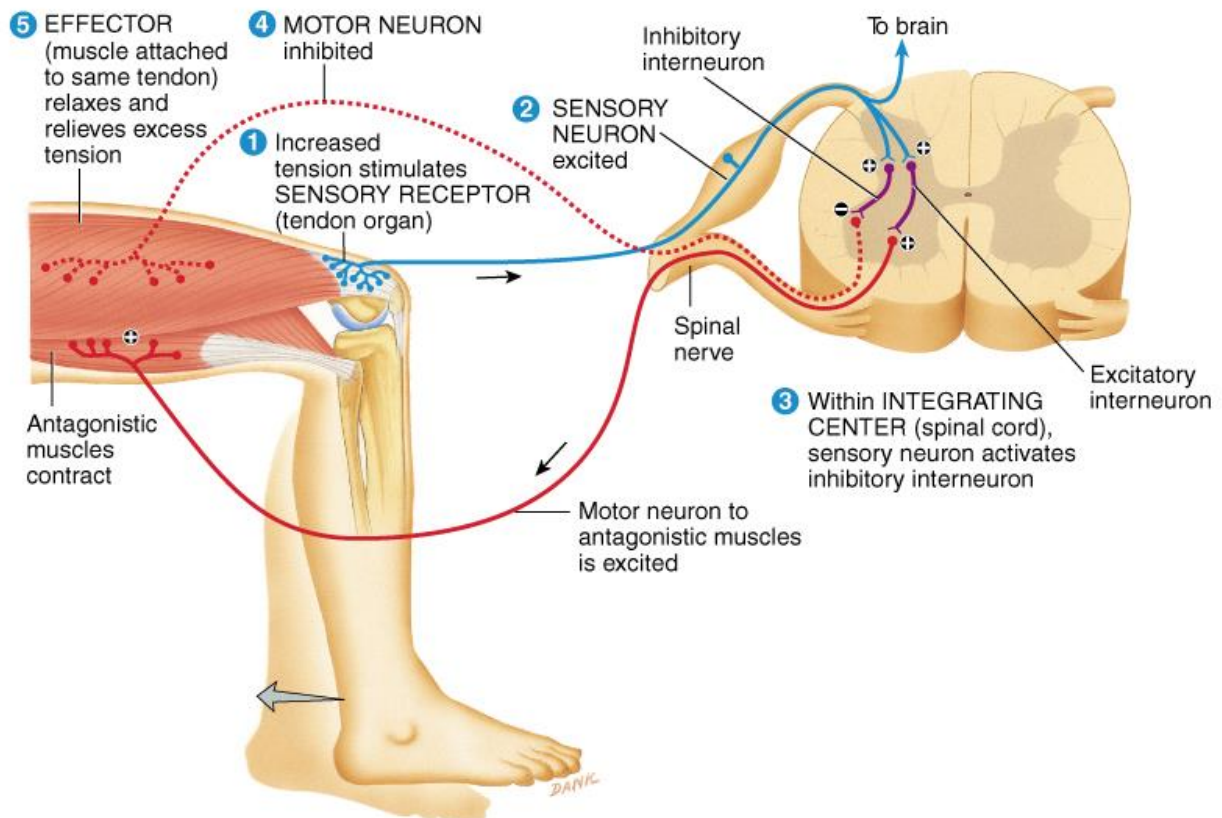

Figure 2.10. Illustration of the Golgi Tendon Reflex. From “The spinal cord and spinal nerves,” by G.J. Tortora and B. Derrickson, 2014, principles of anatomy and physiology, p.465. Copyright 2014 by Gerard J. Tortora, L.L.C., Bryan Derrickson, John Wiley & Sons, Inc.

Stretch Tolerance Models

The sensory theory has been proposed, which suggests that increases in muscle extensibility are due to a person’s increase in stretch (pain) tolerance (i.e. an increased tolerance to the perceived stretch “sensation” or a desensitising psychological influence). According to this theory, the individual becomes more familiar, less fearful and therefore more tolerant of stretching discomfort/pain rather than any change in the muscle tissue itself allowing for movement through a greater ROM (Weppler & Magnusson, 2010).

Magnusson, Simonsen, Aagaard, and Kjaer (1996) provided evidence in support of a mechanical model for the improved flexibility after stretching. They

reported that an acute bout of stretching was associated with a transient increase in tissue compliance (reduced stiffness). This means that the muscle can be stretched further for a given level of force (creep deformation). This change is defined as a right shift in the force-elongation curve (Figure 2.11). However, these viscoelastic responses are transient, lasting several minutes to an hour (Magnusson, Simonsen, Aagaard, & Kjaer, 1996). It has been assumed that regular stretching has a cumulative effect in which this right shift would become permanent, i.e. the tissue will become longer and more compliant.

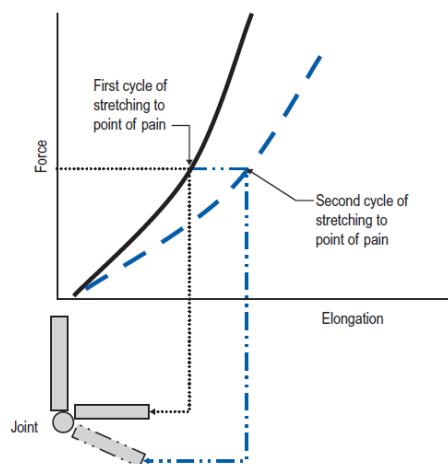

Figure 2.11. Range of movement increase owing to a change in tissue stiffness. From “Stretch-tolerance Model,” by E. Lederman, 2014, *Therapeutic Stretching: Towards a Functional Approach*, p.154. Copyright 2014 by Churchill Livingstone.

Several other studies, however, demonstrated that the force-elongation profile at the onset of training remained unchanged following several weeks of stretching (Ben & Harvey, 2010; Björklund, Djupsjöbacka, & Crenshaw, 2006; Chan, Hong, & Robinson, 2001; Folpp, Deall, Harvey, & Gwinn, 2006; Halbertsma, Mulder, Göeken, & Eisma, 1999; Halbertsma et al., 1996; Kubo et al., 2002b; LaRoche & Connolly, 2006; Law et al., 2009). After regular stretching, a right shift was not evident, only the point at which a person experienced discomfort shifted along the force-

elongation curve (Figure 2.12). This suggests that that the increased ROM is a psychological-sensory phenomenon rather than an adaptive tissue change.

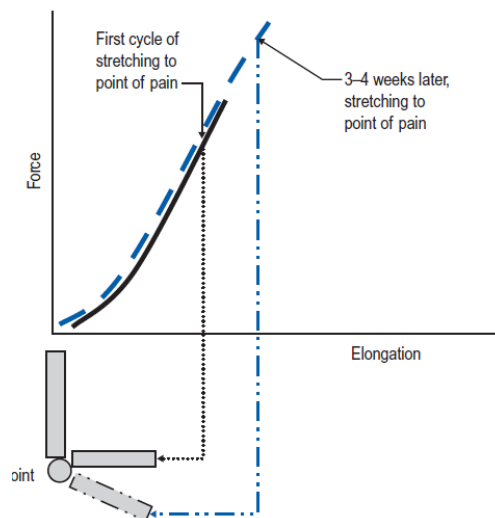

Figure 2.12. Range of movement increase as a shift along the force-elongation curve. From “Stretch-tolerance Model,” by E. Lederman, 2014, *Therapeutic Stretching: Towards a Functional Approach*, p.155. Copyright 2014 by Churchill Livingstone.

A short review by Shrier (2000) suggested that stretching somehow increased pain tolerance and had an analgesic effect. LaRoche and Connolly (2006) concluded that increases in ROM after a static and a ballistic stretching were more likely due to an increase in stretch tolerance than to changes in muscle elasticity. Halbertsma and Göeken (1994) and Halbertsma et al. (1996) concluded that the measured improvements in ROM were primarily attributed to an increased stretch tolerance rather than decreased stiffness or changes in muscle elasticity.

It is suggested that this increased stretch tolerance is induced by natural analgesic responses of the body (Ben & Harvey, 2010; Magnusson, 1998; Marshall, Cashman, & Cheema, 2011; Weppeler & Magnusson, 2010). Stretching at the end ROM is painful and painful stimuli cause the release of Substance P, a neurotransmitter in the Lateral Spinothalamic Tract (the pathway in which pain

signals travel from the receptor to the brain (De Felipe et al., 1998; Piercey, Moon, Blinn, & Dobry-Schreur, 1986). Activation of the descending pain suppression system results in an individual becoming less sensitive to painful stimuli (i.e. maximal stretch) and therefore can tolerate higher levels of this stimulus (i.e. greater degree of stretch resulting in greater ROM) (Pert, 1982). Furthermore, it is accepted that pain perception can be affected by dynamic exercise (Koltyn, 2000; Sforzo, 1989) due to the activation of the endogenous opioid system in which the release of endorphins and enkephalin blocks the production of 'Substance P' thus altered perception as a result of dynamic stretching could contribute to the mechanism of dynamic stretching. Additionally, there is a possibility of contribution from mechanoreceptors to the decreased pain perception via gate control. This happens when stimulation of these receptors by distortion, pressure or stretch causes pre-synaptic inhibition of nociceptive signals (Terman, Shavit, Lewis, Cannon, & Liebeskind, 1984).

Several structural, physiological as well as neural mechanisms can be potentially affected via a stretching intervention. With the potential effect of stretching on altering muscle and tendon mechanical properties, sensory receptors within the muscle, muscle tendon junction, as well as other physiological mechanisms controlling recruitment of motor units can be affected and influence both reflex and voluntary contraction of the muscle.

Types of Stretching

Different types of flexibility exercises fall under the umbrella term of stretching despite their potential differential effects on performance outcomes. Coaches, physiotherapists and athletic trainers have long recognised the need for high flexibility in specific or group of joints. To help athletes achieve this flexibility range, they have developed special stretching exercises and drills.

There are four major types of stretching, which are employed in the sports environment or clinical practice (Behm & Chaouachi, 2011; Shellock & Prentice, 1985). Stretches may be:

- a) static
- b) dynamic
- c) ballistic
- d) Proprioceptive Neuromuscular Facilitation (PNF)

Static Stretching

Static stretching is the most widely accepted type since it is considered as an effective intervention to increase flexibility and ROM (Decoster, Cleland, Altieri, & Russell, 2005; Garber et al., 2011; Hertling & Kessler, 2006; Law et al., 2009; R. Nelson & Bandy, 2004; Ryan et al., 2008; Weppeler & Magnusson, 2010) and is the easiest and safest stretching to perform since it has little-associated risk of injury (Kolber & Zepeda, 2004; Vries, 1962). It owes its popularity to the release of the book "Stretching" from Anderson (1980) who introduced static stretching to the world. In this type of stretching the limb is taken to a point where tension is felt (point of discomfort) and then held at this position for a certain duration (hence the term "static") ranging from a few seconds to minutes (Paine, 2015). As the muscle tendon unit is stretched, passive force increases to the end point of the stretch at maximum tolerable length. If the final stretch length is maintained, passive force begins to decline (stress relaxation) (Chalmers, 2004; Magnusson, 1998). The rate of stress relaxation is initially fast but progressively slows down. Stress relaxation may continue as long as the stretch is maintained (Fowles et al., 2000). Most of the stress relaxation occurs during the first 20-30 seconds of a maintained stretch, a duration which is more typically of a stretch routine used by athletes since a stretch of 15-30 seconds is suggested as the most effective for increasing muscle flexibility (Bandy & Irion, 1994; Madding, Wong, Hallum, & Medeiros, 1987). For a stretch duration of 20-30 seconds, the magnitude of stress relaxation is about 10-15% (Fowles et al., 2000; Magnusson et al., 1995). The slow build-up of tension and the absence of pain during the stretching are believed to minimise stretch reflex responses, thus inducing muscular relaxation and allowing further stretching (Guissard & Duchateau, 2006).

Kay and Blazevich (2012) classified four SS categories depending on the duration of holding the stretch:

- <30 s of continuous static stretching
- 30-45 s of continuous static stretching
- 60-120 s of continuous static stretching
- >120 s of continuous static stretching.

Paine (2015) categorised two forms of static stretching:

- Maintenance stretching: short duration, 6-10 seconds. Maintenance stretches are used prior to exercise to take the tissues to their maximum comfortable range.
- Developmental stretching: long duration, 20-30 seconds. For developmental stretching, exercises are used with the aim to increase muscle length, beyond its normal ROM, and so a thorough warm-up is first needed.

Maintenance stretches form part of a warm-up, while developmental stretches are practised in a separate stretching occasion.

Static stretching can be passive or active (Winters et al., 2004). Active (static) stretching refers to stretching in which the application of force comes from the active isometric or concentric contraction of one muscle to its full inner range, promoting a stretch of the antagonist's outer range. It is a slower-speed version of classic dynamic stretching. There is excellent control of the stretching force, lessening the possibility of injury. Winters et al. (2004) and Webright, Randolph, and Perrin (1997) suggested that active stretching can show improvements in ROM roughly equal to those found in static stretching.

Passive (static) stretching is one where one assumes a position is relaxed and makes no contribution and a prop is used to exert a force in an effort to increase ROM either manually or mechanically. Passive assisted is similar to passive (static) stretching the only difference is that a partner is used to exert a force to deepen a stretch in an effort to increase ROM instead of a prop. Due to the greater external force applied to the muscle, this form of stretching is slightly more hazardous than active.

Ballistic Stretching

Ballistic stretching is a rapid, forceful intermittent movement where a muscle is taken to its maximum length (end of ROM) and then a stretching force is applied in the form of a bounce/swing in a repetitive manner (Covert, Alexander, Petronis, & Davis, 2010). It is characterised by vigorous bouncing movements that create momentum that takes the body segment quickly beyond normal ROM to stretch shortened structures (Paine, 2015). This type of stretching is considered to be less effective in improving flexibility than other types of stretching (Bacurau et al., 2009; Bandy, Irion, & Briggler, 1998; Covert et al., 2010; Sady, Wortman, & Blanke, 1982; Wallin, Ekblom, Grahn, & Nordenborg, 1985) and over the years, fitness experts have questioned the safety of this type of stretching (Astrand, Rodahl, Dahl, & Stromme, 2003; Prentice, 2015).

The bouncing may cause the intermittent application of excessive tension to the muscle-tendon unit causing muscle microtrauma due to the overstretch of the muscle, it is therefore associated with increased potential of injury to the muscle tendon unit, and it is thus avoided (Hartig & Henderson, 1999; Hedrick, 2000; Page, 2012; D. Taylor et al., 1990; Thacker et al., 2004). Additionally, the rapid application of tension may inappropriately trigger the stretch reflex causing the muscles to contract and tighten (Norris, 2004), making it not the most productive or safest method to lengthen tissue (Guissard & Duchateau, 2006). Ballistic stretching is not recommended as a component of an effective warm-up for the vast majority of the population. It should be avoided by persons with a history of lower back and/or hamstring injuries.

Proprioceptive Neuromuscular Facilitation Stretching

Proprioceptive neuromuscular facilitation (PNF) stretching was developed in the late 1940s and early 1950s by Dr Herman Kabat, with Charles Sherrington's work on spinal mechanisms of stretch reflex being used to justify the procedure (Sandel, 2013). Proprioceptive neuromuscular facilitation stretching is commonly used in the sporting context; however, it was first developed for use in rehabilitation programs for patients with neurological dysfunctions (Knott & Voss, 1956).

Proprioceptive neuromuscular facilitation stretching procedures were subsequently developed on the basis of several important neurophysiological mechanisms (Chalmers, 2004).

There are three PNF stretching techniques reported in the literature: hold-relax (HR); contract-relax (CR); and contract-relax-antagonist-contract (CRAC), which base themselves on the principles of successive induction, muscle relaxation, and reciprocal innervations respectively. However, they are not the sole reason for increased ROM, as viscoelastic and neurological adaptations contribute to the gains of PNF (Burke, Culligan, & Holt, 2000).

The muscle to be stretched is referred to as the target muscle, and the muscle that is an antagonist to the target muscle is referred to as the opposing muscle (Chalmers, 2004; Sharman & Cresswell, 2006).

The contract-relax technique involves a slow stretch of the relaxed target muscle to maximal tolerable length and holding it there for several seconds. The therapist provides resistance; the athlete isometrically contracts the target muscle for a few seconds (e.g. 6-10 seconds) at the held length. S/he then moves the limb into the new length and again held for several seconds. Usually, a total of three repetitions of the cycle are performed. This is based on the theory of autogenic inhibition. Autogenic inhibition refers to a reduction in excitability of a contracting or stretched muscle through increased inhibitory input arising from the Golgi tendon organs (Laporte & Lloyd, 1952). This reduced motor feedback to the muscle is believed to assist target muscle elongation (Etnyre & Abraham, 1986b; Markos, 1979; Prentice, 1983; Tanigawa, 1972). The Golgi tendon organs also decrease the afferent flow of impulses from muscle spindle fibres, in an attempt to avoid injury during stretching.

The hold-relax technique of PNF is characterised by contraction of the opposing muscle against a resistance provided by the therapist while simultaneously stretching and relaxing the target muscle. The theory behind this technique is based on reciprocal inhibition which is where an agonist (opposing) muscle is contracted, and the antagonist (target) muscle is inhibited to produce relaxation (Voss, Ionta, & Myers, 1985). The mechanism is thought to be as a result of increased Ia-afferent

impulses from agonist muscle spindles, exciting the α -inhibitory motoneurons in the spinal cord, causing inhibition of the activity in the alpha motoneurons of the antagonist (target) muscle (Fox, 2006; Leonard, 1998).

The third PNF technique is called contract-relax-antagonist-contract (CRAC) and uses a combination of the contract-relax and hold-relax techniques. The range limiting muscle is lengthened to the point of first resistance. The patient then performs a pre-stretch, end range isometric contraction of the opposing muscle, followed by an isometric contraction of the target muscle after which they actively move the target muscle to the point of maximal tolerable length where it is held for several seconds. The cycle is usually repeated three times. Several studies have demonstrated that PNF techniques incorporating reciprocal inhibition and involving an isometric contraction of the antagonist (opposing) muscle achieve higher gains in ROM (Cornelius & Hinson, 1980; Etnyre & Abraham, 1986a, 1986b; Hardy, 1985; M. Moore & Hutton, 1980; Osternig, Robertson, Troxel, & Hansen, 1987, 1990; Prentice, 1983) owing to increased suppression of the motor pool, which is indicated by early post-contraction latencies (Etnyre & Abraham, 1986b).

Dynamic Stretching

More recently, ballistic stretching procedures have been adapted to become more controlled, through the active range of motion movements (with muscle contraction) (Fletcher, 2010). This is done at either single or multiple joints rather than end of range techniques, and these types of stretches have been termed dynamic stretching (Behm & Chaouachi, 2011; Fletcher & Jones, 2004). Dynamic stretching involves a gradual transition from one body position to another, and a progressive increase in reach and ROM as the movement is repeated several times (McMillian, Moore, Hatler, & Taylor, 2006). Dynamic stretching consists of functional based exercises, which use sport specific movements to prepare the body for activity (Mann & Jones, 1999). Dynamic flexibility programs are designed from analysing the movements associated with a particular sports activity and developing stretches to enhance flexibility and balance necessary for the activity (Craib et al., 1996; Gambetta, 1997). Dynamic stretching consists of exercises designed to stretch

target muscles, for example, upward leg kicks to stretch the hamstrings (O'Sullivan, Murray, & Sainsbury, 2009) and flick-backs to stretch the quadriceps (Fletcher & Jones, 2004) while relaxing the antagonist muscle (Alter, 2004; Kurz, 2003). In many dynamic stretching exercises, there is no particular attempt to stretch the muscle to the maximum ROM (McMillian et al., 2006). By using controlled movement, this type of stretching also lubricates the joints by stimulating the production of synovial fluid (Paine, 2015). Also, this is an activity-specific functional exercise that utilises sport-specific (or activity specific) movements to prepare the body for activity (Norris, 2004).

Sport specific movements require dynamic muscle action through the transfer of energy from a tendon to a muscle in order to produce maximal force. The successive combination of eccentric and concentric contractions forms the most common type of muscle function and is termed the stretch-shortening cycle (SSC) (Cavanagh & Komi, 1979; Komi, 1986). During the eccentric action phase, the muscle is activated so that elastic energy is stored at the tendon which is then released during the subsequent shortening phase, thus increasing the muscle force output (potentiation). A muscle that can be stretched to its optimal length during an eccentric contraction stores maximal energy in the tendon to be returned in the subsequent concentric contraction producing maximal force (G. Wilson, Elliott, & Wood, 1992). Static stretching appears to negatively affect the energy transfer in force production due to the change in the mechanical properties and temperature of the muscle; yet active stretching probably does not appear to have the same effect on these properties (McMillian et al., 2006; Yamaguchi & Ishii, 2005).

Dynamic stretching improves dynamic flexibility and is quite useful as part of a warm-up for an active or aerobic workout (i.e. dance or martial arts class) (Kurz, 2003). Because dynamic flexibility exercises require balance and coordination, many athletes experience muscle soreness (DOMS) for a period following dynamic stretching (Gambetta, 1997; Mann & Jones, 1999).

Although dynamic stretching is distinguished from ballistic stretching by the inclusion of controlled actions (Fletcher & Jones, 2004), some dynamic stretching movements seem similar to ballistic stretching, and the terms have been used synonymously (Behm & Chaouachi, 2011; Woods et al., 2007). In dynamic

stretching, the stretch is not sudden, unlike in ballistic stretching (Kurz, 2003). Dynamic stretching can increase maximum ROM acutely but not to the same extent as static stretching (Behm & Chaouachi, 2011; Woods et al., 2007). It has recently been found that dynamic stretching decreases passive stiffness and passive resistive torque similar to those reported following static stretching (Herda et al., 2013).

Acute Effects of Dynamic Stretching on Aspects of Performance

The effect of stretching of muscle-tendon unit on aspects of function and performance and prevention of injury has been examined in several ways. A review of current knowledge on these issues is provided below.

Maximum Range of Motion and Passive Force/Torque

Performance improvements after an acute bout of dynamic stretching have been reported in the literature (Behm & Chaouachi, 2011; Kallerud & Gleeson, 2013). However, there is a limited number of studies which have investigated the effects of dynamic stretching on joint ROM and other biomechanical properties of the muscle-tendon unit (Aguilar et al., 2012; Behm et al., 2011; Boyle, 2004; Fletcher & Monte-Colombo, 2010a; Herda et al., 2013; O'Sullivan et al., 2009; Samukawa et al., 2011; Zourdos et al., 2012). There are conflicting results in the literature, with some studies reporting either similar (Perrier, Pavol, & Hoffman, 2011) or greater (Amiri-Khorasani, Abu Osman, & Yusof, 2011) increases in flexibility with dynamic stretching than static stretching whereas others have reported that dynamic stretching can increase maximum ROM acutely but not to the same extent as static stretching (Bandy et al., 1998; McMillian et al., 2006; Paradisis et al., 2014). Unfortunately, ROM changes after dynamic stretching have not been monitored for a period of time after the stretching intervention.

Samukawa et al. (2011) reported that plantarflexion joint ROM increased following 150 seconds of dynamic stretching, however, no changes have been found

in muscle fibre pennation angle and fascicle length but a significant displacement of the muscle tendon junction indicating an elongation of the tendon tissues. It is now known that dynamic stretching decreases passive torque and passive stiffness at different muscle tendon unit lengths (Herda et al., 2013). However, it is not possible to rank stretching methods in order of their effectiveness, as both static stretching and dynamic stretching have been shown to increase ROM.

Strength, Power, and Speed

When dynamic stretching was incorporated into a warm-up, improvements in power (McMillian et al., 2006; Yamaguchi & Ishii, 2005), jump performance (Carvalho et al., 2012; Curry, Chengkalath, Crouch, Romance, & Manns, 2009; Fletcher & Monte-Colombo, 2010a; Hough et al., 2009; Little & Williams, 2006; Needham, Morse, & Degens, 2009; Perrier et al., 2011; Turki et al., 2011; Vetter, 2007) and agility (Gelen, 2010; Little & Williams, 2006; Needham et al., 2009) were documented.

Stretch-induced strength loss is dependent on the stretching technique applied, the contraction type used for measuring loss, and the muscle in which strength is measured (McHugh & Cosgrave, 2010). Dynamic stretching has been shown to enhance performance when instituted prior to strength and power activities (Behm et al., 2011; Carvalho et al., 2012; Curry et al., 2009; Fletcher, 2010; Fletcher & Monte-Colombo, 2010a; Holt & Lambourne, 2008; Needham et al., 2009; Pearce, Kidgell, Zois, & Carlson, 2009; Perrier et al., 2011; Turki et al., 2011; Yamaguchi, Ishii, Yamanaka, & Yasuda, 2007).

Concerning contraction type, it has been shown that there is no stretch-induced strength loss with dynamic stretching (Aguilar et al., 2012; Herda et al., 2008; Hough et al., 2009; Papadopoulos, Siatras, & Kellis, 2005). Sekir, Arabaci, Akova, and Kadagan (2010) found a significant increase in strength in concentric and eccentric peak torque of the hamstring and the quadriceps at 60 deg/s and 180 deg/s which is in agreement with the findings of Manoel et al. (2008) who again found a significant increase in knee extension for the same speeds. Boyle (2004) found similar results for the quadriceps but at a lower speed of ~30 deg/s (0.52

rad/s). Aguilar et al. (2012) found significant improvements in eccentric quadriceps strength at 60 deg/s but not statistically significant increase in concentric torque. Absence of significant difference between pre- and post- dynamic stretching measurement was found by other authors (Ayala, Croix, Baranda, & Santonja, 2013; Ayala, De Ste Croix, Sainz de Baranda, & Santonja, 2014; Herda et al., 2008) on the isometric strength of the plantarflexors. However, a recent study by Costa, Herda, Herda, and Cramer (2014) showed a significant decrease in knee flexors concentric and eccentric torque at speeds of 60 deg/s and 180 deg/s. The discrepancy between these studies might be attributed to the different stretching/experimental protocols (intensity, volume, duration of rest intervals between the consecutive sets) before the execution of the performance activity, gender (Tsolakis, Bogdanis, Nikolaou, & Zacharogiannis, 2011) and the different muscle groups utilised.

Costa et al. (2014) used dynamic stretching that involved controlled repetitions for 30 seconds while not counting the number of repetitions within the 30-second period, Sekir et al. (2010) stretched slowly at first (5 repetitions) and then “as quickly and powerfully as possible” (10 repetitions) which may be more synonymous with a traditional warm-up. Additionally, Costa et al. (2014) testing took place approximately 5 min after stretching. Therefore, the time elapsed between stretching and testing might have allowed small changes in torque development capacity to dissipate. A longer delay might have permitted torque producing capacity to return to baseline between the end of the dynamic stretching intervention and strength assessment. Ayala et al. (2013) found no strength induced changes in eccentric peak torque of the hamstrings muscles at speeds of ~ 60 deg/s and ~ 180 deg/s stretched at a speed of one stretch cycle every 2 seconds (0.5 Hz). However, the stretching of this study was one quarter of the duration of the dynamic stretching protocol used by Costa et al. (2014) – 16.1 ± 2.6 min as well as a slower stretching speed which might be one of the reasons the protocol had no effect on muscle eccentric strength. Additionally, the participants in the Ayala et al. (2013) study were homogenous based on age and physical status, which could limit the external validity of the results.

Increases in vertical jump height have been reported in many studies following dynamic stretching (Behm et al., 2011; Carvalho et al., 2012; Chtourou et al., 2013; Curry et al., 2009; Faigenbaum, Bellucci, Bernieri, Bakker, & Hoorens, 2005; Fletcher, 2010, 2013; Fletcher & Monte-Colombo, 2010a; Haddad et al., 2014; Holt & Lambourne, 2008; Hough et al., 2009; Kruse, Barr, Gilders, Kushnick, & Rana, 2013; Needham et al., 2009; Pearce et al., 2009; Perrier et al., 2011; K. Taylor, Sheppard, Lee, & Plummer, 2017; Thompsen, Kackley, Palumbo, & Faigenbaum, 2007; Vetter, 2007; Wright, Williams, Greany, & Foster, 2006) while others (Christensen & Nordstrom, 2008; Dalrymple, Davis, Dwyer, & Moir, 2010; Jagers, Swank, Frost, & Lee, 2008; Little & Williams, 2006) found no significant effect on vertical jump performance. One study reported no significant effect on bench press and leg press one-repetition maximum performance (Beedle, Rytter, Healy, & Ward, 2008). These discrepancies may again be attributed to the stretching protocol (intensity, volume, frequency, duration of rest intervals between the consecutive sets, contracting the muscle group agonist and/or antagonist to the target muscle group) before the execution of the performance activity, gender (Tsolakis et al., 2011), the training status of the participants as well as and the different muscle groups utilised. This may be because the movement velocity or task of the exercise does not correspond to the dynamic stretching movement velocity or task (replication of movement task). Paradisis et al. (2014) found a decrease in explosive power after dynamic stretching, however, the average age of the population was 14.6 ± 1.7 years, and therefore the results could not be generalised.

Pearce et al. (2009) found an increase in vertical jump height after the movement was combined with dynamic stretching, lasting up to 60 min after the secondary warm-up. Pearce, Latella, and Kidgell (2012) compared maximum vertical jump height and a repetitive five repetition jump following static, dynamic and no stretching (control). The vertical jump height in the dynamic stretching condition was significantly increased following the stretching phase and continued to increase after the movement activity phase, while for the static stretching protocol both vertical jump height and repetitive five repetition jump heights were significantly decreased following static stretching compared to dynamic stretching and control. The control condition provided similarly improved vertical jump performance at both

time points, compared with the static stretching condition similar to Pearce et al. (2009) and Wright et al. (2006).

Needham et al. (2009) also found that athletes combining dynamic and front squats (using external resistance of 20% body mass) had higher countermovement jump than athletes performing either dynamic stretching alone or static stretching alone, while dynamic stretching alone produced better performances than those produced by static stretching alone.

Thompsen et al. (2007) used a weighted vest providing a resistance of 10% body mass and dynamic warm-up protocol and found that it provides a higher jumping performance compared to dynamic stretching alone. Nevertheless, Turki et al. (2011) found that dynamic stretching combined with heavy deadlifts, maximal isometric squats, tuck jumps and drop jumps did not benefit countermovement jump performance versus dynamic stretching alone. Additionally, Chattong, Brown, Coburn, and Noffal (2010) used weighted vests equivalent to 5, 10, 15 or 20% of their body mass but found no significant effect comparing the pre and the post-test vertical jump height. The difference between the different results may be attributed to the different duration of the stretching protocol, Chattong et al. (2010) used a protocol of less than 2 min duration while Thompsen et al. (2007) used a protocol consisting of 10 min of dynamic stretching as well as a different type of dynamic stretching.

Paradisis et al. (2014) observed that dynamic stretching did not affect performance in 20 m time in adolescent boys and girls compared with control. This is in agreement with the results of Chaouachi et al. (2010) and Vetter (2007). Fletcher and Anness (2007) showed no differences in 50 m sprint times, and Pearce et al. (2012) did not find any changes in 20 m sprint times following a secondary warm-up after stretching. However, when comparing the results of static stretching to dynamic stretching between adolescent boys and girls, it is clear that dynamic stretching resulted in superior 20 m sprint performance compared to static stretching, which suggests that subjects performed better in 20 m when incorporating the dynamic stretching within the warm-up protocol (Paradisis et al., 2014). This is consistent with Faigenbaum et al. (2005) who have reported a significant difference

between static stretching and dynamic stretching indicating that static stretching has a more detrimental effect on 20 m sprint time compared with dynamic stretching.

Other studies (Fletcher & Jones, 2004; Gelen, 2010; Haddad et al., 2014; Little & Williams, 2006; Needham et al., 2009) found significant improvements in sprint performance. Byrne, Kenny, and O'Rourke (2014) found significant improvements of 2.2% in 20m sprint time between the control and the dynamic stretching protocol; however, an increase of 5.0% was observed between the control and the dynamic protocol plus the addition of 3 depth jumps. Haddad et al. (2014) discovered that sprint performances (10, 20 and 30 m) 24 hours after the dynamic stretching were significantly better than those after the control and static stretching protocol.

Regarding the volume of dynamic stretching, Turki et al. (2012) compared 10 m and 20 m sprint times interspersed amongst one, two and three sets of active dynamic stretching (2 sets x 14 repetitions x 5 exercises). The results indicated that one and two sets of stretching significantly improved (2.7%) 20 m sprint times, but three sets of dynamic stretching significantly impaired (-2.7%) it. However, none of the 3 dynamic stretching protocols affected 10 m sprint time. Little and Williams (2006) used a similar active dynamic protocol of two sets as the second condition of Turki et al. (2012) study and Fletcher and Jones (2004) used an "active" dynamic protocol, i.e., during jogging of the lower limbs as part of a warm-up, compared with active or passive static or static dynamic stretching conditions. Although the duration of "static" dynamic stretching, i.e. in an upright position, was the same as the "active" there was no significant increase in sprint performance for "static" dynamic stretching. The duration and type of which is similar to that of the one and two sets of Turki et al. (2012)'s study. Similar results were reported recently by Fletcher and Monte-Colombo (2010) who showed an enhanced 20 m sprint performance using an "active" dynamic stretching volume of 2 sets of 12 movements in comparison to an active warm-up with and without static stretching. These results suggest that both one and two sets of "active" dynamic stretching are appropriate to perform during the warm-up to acutely enhance 20 m sprint performance in highly trained team sports players. It can be interpreted that small volume of dynamic stretching (i.e. 1-2 sets) can be effective in improving performance in short lasting high-volume sporting

activities (10 m or 20 m sprint). However, a larger volume of dynamic stretching (e.g. 3 sets) would have a detrimental effect possibly due to fatigue.

The lack or presence of stretch-induced disruptions found in other studies may be related to a number of factors including the age and training status of the group, volume, intensity and type (i.e. stationary or moving) of the stretching protocol, and recovery interval between stretching and testing. In the above studies that controlled the volume of dynamic stretching by repetitions, dynamic stretching was performed in a stationary standing position without movement. In this case, no effect of the dynamic stretching on improving explosive performance if the repetitions of the dynamic stretching were few was found but if the repetitions were too many, the explosive performance might have been impaired due to fatigue. Additionally, if an “active” dynamic stretching is performed (the volume controlled by the distance), the warm-up effect, such as elevation of muscle temperature with jogging or walking might have a synergistic effect on explosive performance even if the total distance of dynamic stretching is short.

Table 2.1. Effect of short-term dynamic stretching on strength, power and speed performance.

Authors	Subjects	DS Treatment	Criteria	Results
Aguilar et al. (2012)	45 healthy subjects (23 males, 22 females)	(a) dynamic warm-up (DWU) (b) static stretching warm-up (SWU) (c) control (CON)	(a) Eccentric quadriceps PT (b) Concentric quadriceps PT (c) Eccentric hamstrings PT (d) Concentric hamstrings PT (e) CMJ height (g) VJ power	Significant increase in eccentric quadriceps PT in the DWU condition. No significant effect on strength or VJ height in the CON and SWU conditions.
Ayala, Croix, Baranda, & Santonja (2013)	49 recreationally active adults (25 men and 24 women)	(a) warm-up + no stretching (control) (b) warm-up + SS (c) warm-up + DS	(a) Eccentric knee flexors PT at 1.04 and 3.14 rad/s (b) Eccentric knee flexors work at 1.04 and 3.14 rad/s	No significant effect for all 3 conditions for all outcomes.

Authors	Subjects	DS Treatment	Criteria	Results
Ayala, De Ste Croix, Sainz de Baranda, and Santonja (2014)	49 recreationally active adults (25 men and 24 women)	(a) warm-up + non-stretching (control) (b) warm-up + SS (c) warm-up + DS	(a) Total response time (b) Pre-motor time (c) Motor time	No significant effect for all 3 conditions for all outcomes.
Amiri-Khorasani, Sahebozamani, Tabrizi, and Yusof (2010)	19 soccer players	(a) Jog + SS (b) Jog + DS (c) Jog + combined (d) Jog	Illinois agility test	Significant decrease in agility time following DS vs SS in both less and more experienced players. SS not detrimental to agility when combined with a dynamic warm-up for agility players.
Beedle et al. (2008)	51 participants (19 men, 32 women)	(a) no stretching (NS) (b) SS (c) DS	(a) Bench press (BP) 1RM (b) Leg press (LP) 1RM	No significant differences in DS and NS on both 1 RM in the BP and LP conditions for all subjects

Authors	Subjects	DS Treatment	Criteria	Results
Behm and Chaouachi (2011)	18 participants (10 young men and 8 middle-aged men)	(a) warm up + SS (b) warm-up + DS (c) warm-up only (control)	(a) DJ height (b) CMJ height (c) Static balance (d) Reaction and movement time	and by gender. DS significantly enhanced DJ and CMJ height compared to SS and control condition for both age groups. SS and DS Sit and reach post-intervention scores were significantly greater than pre-intervention scores.
Byrne et al. (2014)	29 active male students	(a) jogging (control) (b) jogging + DS (DYN) (c) jogging + DS + depth	20 m sprint time	Significant improvement of 2.2% in sprint time between the control and DYN protocol and a further

Authors	Subjects	DS Treatment	Criteria	Results
Carvalho et al. (2012)	16 young male tennis players	<p>general + specific warm-up + 5 min of running followed by 10 jumps then:</p> <p>(a) 5 min passive rest</p> <p>(b) 5 min passive stretching condition (PSC)</p> <p>(c) 5 min active static stretching condition</p>	<p>(a) 3 SJs height</p> <p>(b) 3 CMJs height</p>	<p>significant improvement of 5.01% was observed between the control and the DYNDJ protocol. Significant improvement of 2.93% was observed between the DYN and the DYNJ protocol.</p> <p>Significant decrease for ASC and PSC compared to control and significant increase in SJ performance in DC vs PSC. For CMJs, no significant decrease for PS, AS and DS when compared to control but significant increase in CMJ in DC and ASC with PSC.</p>

Authors	Subjects	DS Treatment	Criteria	Results
		(ASC)		
		(d) 5 min of DS condition		
		(DC)		
Chtourou et al. (2013)	20 male soccer players	(a) warm-up + no-stretching (control)	(a) 3 SJs height	Significantly greater increase in SJs and CMJs height in the morning than in the evening between control and DS condition.
		(b) warm-up + SS	(b) 3 CMJs height	
		(c) warm-up + DS		
Chaouachi et al., (2010)	22 highly trained male student athletes	(a) Warm-up + SS to point of discomfort (POD)	(a) 30 m sprint time	No significant differences in all other conditions and tests except for the control condition which showed significant difference for faster times than the DS + SS < POD in the 30m sprint.
		(b) Warm-up + SS < POD	(b) agility run (T-test)	
		(c) Warm-up + DS	(c) CMJ height	
			(d) 5 jump tests	

Authors	Subjects	DS Treatment	Criteria	Results
Christensen and Nordstrom (2008)	68 university athletes (36 men, 32 women)	(d) Warm-up + SS POD + DS	VJ height	No significant difference in the combined men's or women's results or no significant difference between sex on VJ performance in all stretching conditions.
		(e) Warm up + SS < POD + DS		
		(f) Warm-up + DS + SS POD		
		(g) Warm- up + DS + SS < POD		
		(h) Control		
		(a) 600m jog		
		(b) 600m jog + DS		
		(c) 600m jog + PNF		
		split into 6 groups and conditions rotated between the 3 routines,		

Authors	Subjects	DS Treatment	Criteria	Results
Costa et al. (2014)	21 females	(a) DS (b) Control	(a) Concentric PT at 60°/s and 180°/s of the quadriceps and hamstring muscles (b) Eccentric PT at 60°/s and 180°/s of the quadriceps and hamstring muscles (e) H:Q conventional ratio at 60°/s and 180°/s	Hamstrings concentric and eccentric PT decreased under both interventions and speeds whereas hamstring eccentric PT decreased only after DS.
Curry et al. (2009)	24 recreationally active females	(a) warm-up (b) warm-up + light	(a) CMJ height (b) Time to peak isometric	No significant differences between warm-ups on any of the variables.

Authors	Subjects	DS Treatment	Criteria	Results
		aerobic activity (c) Warm-up + SS (d) Warm-up + DS	force	Significant improvement in CMJ and TPF only in DS and light aerobic activity conditions.
Dalrymple, Davis, Dwyer, and Moir (2010)	12 female collegiate volleyball players	(a) Jogging + SS (b) Jogging + DS (c) Jogging (control)	CMJ height	No significant difference between all conditions.
Faigenbaum et al. (2005)	60 children (27 girls and 33 boys)	(a) 5 min walking + 5 min SS (b) 10 min of dynamic exercises from moderate to high intensity (DY) (c) 10 min dynamic exercises (same as (a)) followed by 3DJ from 15	(a) VJ height (b) Long jump distance (c) Shuttle run time	Significant increase in VJ height after DY and DYJ compared to SS. Long jump performance was significantly reduced following SS as compared to DYJ.

Authors	Subjects	DS Treatment	Criteria	Results
		cm box (DYJ)		
Fletcher (2010)	24 males	(a) No stretch (NS) (b) Slow dynamic stretch (SDS) 50 beats/min (c) Fast dynamic stretch (FDS) 100 beats/min	(a) CMJ height (b) DJ height (c) SJ height	FDS significantly greater jump height in all test compared to SDS and NS conditions.
Fletcher & Anness (2007)	18 experienced sprinters	(a) warm-up + active dynamic stretching (ADS) (b) warm-up + static passive stretch combined with ADS (SADS) (c) warm-up + static dynamic stretch	50 m sprint time	After SADS significant slower 50 m sprint than either after ADS or DADS.

Authors	Subjects	DS Treatment	Criteria	Results
Fletcher and Jones (2004)	97 male rugby players	combined with ADS (SADS) (a) Passive static stretching (PSS) (b) Active dynamic stretching (ADS) (c) Active static stretching (ASST) (d) Static dynamic stretching (SDS)	20 m sprint time	After PSS and ASST significant decrease in performance. After ADS improvement in sprint performance. After SDS improvement of sprint performance but non-significant.
Fletcher and Monte-Colombo (2010)	27 male soccer players	(a) active warm-up (WU) (b) WU + static stretching (SPS) (c) WU + dynamic stretching (ADS)	(a) Heart rate (HR) (b) CMJ height (c) 20m sprint time (d) Balsom agility test (s)	CMJ height significantly greater in WU + ADS condition computed to SPS. SPS was significantly slower than WU + ADS, with ADS being significantly faster

Authors	Subjects	DS Treatment	Criteria	Results
Fletcher and Monte-Colombo (2010)	21 male collegiate semi-professional players	(a) no stretch warm-up (WU) (b) warm-up + static passive stretching (SPS) (c) warm-up + static dynamic stretching (SDS)	(a) CMJ height (b) DJ height (c) Concentric PT knee extension at 30 & 300°/s (d) Concentric PT knee flexion at 30 & 300°/s Time to peak torque (TPT) knee extension at 30 & 300°/s TTPT knee flexion at 30 & 300°/s (c) PT	<p>than WU. HR was significantly higher in WU and ADS than SPS conditions.</p> <p>Significant increase in performance for CMJ, DJ, and PT for SDS compared to WU and SPS. Significant increase in EMG activity in SDS compared to SPS condition and significant increase in HR in SDS than SPS + WU.</p>

Authors	Subjects	DS Treatment	Criteria	Results
Fletcher (2013)	16 male collegiate athletes	a) control (CO) (b) active warm-up (AWU) (c) dynamic stretch (DS) (d) back squat protocol (BS)	(a) CMJ height (b) SJ height (c) DJ height	Significant increases in jump height, with an increase in performance from pre- to post-AWU, increased further by the DS and again increased after the BS. Significantly greater increase in jump height in the DS and BS component compared to the AWU.
Gelen (2010)	26 male professional football players	(a) Jogging (b) Jogging + SS (c) Jogging + DS (d) Jogging + SS + DS	(a) Sprint time (b) Slalom dribbling time (c) Penalty kick speed	Significant increase in performance for jogging + SS and jogging + DS compared to jogging and jogging +SS + DS. However, performance for jogging + DS was significantly better than

Authors	Subjects	DS Treatment	Criteria	Results
				jogging + SS.
Haddad et al. (2014)	16 young male soccer players	(a) warm-up + SS (b) warm-up + DS (c) warm-up (control condition)	(a) 5 Jump Tests (JT) (b) 30 m sprint test (c) 20 m sprint test (d) 10 m sprint test	Significantly better performance after DS compared to the CC and SS in 5 JT and sprint times for 10, 20 and 30 m after 24 hours. Significantly worse performance after SS compared to the CC in 5 JT and sprint times for 10, 20 and 30 m after 24 hours. No significant difference in RSA for all conditions.
		(a) SS (4 sets X 3	(a) Isometric PT during	Significant decrease in PT

Authors	Subjects	DS Treatment	Criteria	Results
Herda et al. (2008)	14 males	<p>exercises X 30s for the right hamstrings)</p> <p>(b) DS (4 sets X 3 exercises 12-15 reps with each set lasting 30s for the right hamstrings)</p>	<p>MVIC at knee joint angles of 41°, 61°, 81° and 101° below full leg extension.</p> <p>(b) EMG RMS amplitude at knee joint angles of 41°, 61°, 81° and 101° below full leg extension.</p>	<p>after SS at 81° and 101° but not at other angles. No significant changes in PT after DS.</p>
Holt and Lambourne (2008)	64 male football players	<p>(a) warm-up</p> <p>(b) warm-up + SS</p> <p>(c) warm-up +DS</p> <p>(d) warm-up + dynamic flexibility</p>	CMJ height	<p>Pre-test performance same for all warm-up groups. Post-test performance for the SS group (VJ height gain) was significantly less than the 3 other groups.</p>
Hough et al. (2009)	11 healthy males	<p>(a) warm-up (control)</p> <p>(b) warm-up + SS</p>	VJ height	<p>Significant increase in VJ height and EMG in DS vs SS and control. Significant decrease in VJ and EMG</p>

Authors	Subjects	DS Treatment	Criteria	Results
		(c) Warm-up + DS		for SS than DS and control.
Jagers et al. (2008)	20 college students (10 males, 10 females)	(a) warm-up + no stretch (control) (b) warm-up + ballistic stretch (BS) (c) warm-up + DS	(a) CMJ height (b) Maximal power (c) Maximal force	No significant difference of BS to control in terms of jump height, force or power. Significant difference between control and DS in terms of jump power but no significant difference in jump height or force.
Kruse et al. (2013)	11 female highly trained players	(a) SS (b) control (general aerobic warm-up) (c) DS	3 CMJs at 1, 5, 15, and 25 min post-intervention	Significant increase in CMJ performance for the DS than the SS and control session at 1 and 5 post-intervention, but not at 15 and 25 min post-intervention. Significant

Authors	Subjects	DS Treatment	Criteria	Results
Kruse, Barr, Gilders, Kushnick, and Rana (2015)	10 female, collegiate varsity volleyball players	(a) SS (b) DS (c) Control	(a) CMJ height (b) Peak force (c) average rate of force development (d) time-to-take off at 1 vs 15 min	decrease at 1 min post stretch compared to 5 min post stretch compared to 15 and 25 min post stretch. DS caused an acute improvement in all parameters 1 min after stretching when compared to an equal duration of SS. No significant effect was detected at 15 min.
Little and Williams (2006)	18 professional soccer players	(a) warm-up (control) (d) Warm-up + DS (c) warm-up + SS	(a) CMJ height (b) Stationary 10 m sprint (c) Flying 20 m sprint time (d) Agility run time	Significant decrease in stationary 10m sprint acceleration time in SS and DS groups. Significant decrease in flying 20m maximum speed time and Zig-Zag agility test in DS.

Authors	Subjects	DS Treatment	Criteria	Results
Manoel et al. (2008)	12 recreationally active females	(a) warm-up + SS (b) warm-up + DS (c) warm-up + PNF stretching (d) warm-up (control)	Concentric knee extension power at 60°/s and 180°/s	No significant difference in CMJ height for all 3 groups. Significant increase in knee extension at 60°/s and 180°/s after DS than SS and PNF.
McMillian et al. (2006)	30 cadets	(a) Static stretching warm-up (SWU) (b) Dynamic stretching warm-up (DWU) (c) No warm-up (NWU) (control)	(a) T-shuttle run (b) Medicine ball throw (c) 5-step jump	Significant increase in performance for all tests in the DWU condition than SWU or NWU conditions.

Authors	Subjects	DS Treatment	Criteria	Results
Needham et al. (2009)	22 elite youth soccer players	(a) jog + SS (b) jog + DS (c) jog + DS + 8 front squats+20% body mass (DSR)	(a) CMJ height at 0, 3 and 6 min post stretching (b) 10 m sprint time at 0, 3 and 6 min post stretching (c) 20 m sprint time at 0, 3 and 6 min post stretching	Significant increase in CMJ height in DSR at 3 and 6 min than after SS, which was better than after SS at 0, 3 and 6 minutes. Significant improvement in CMJ performance at 3 min than immediately after, this was maintained at 6 min after DSR. Significant improvement in sprint time after DSR and DS compared with SS at 0, 3 and 6 min post stretching.
Paradisis et al. (2014)	47 adolescents	(a) warm-up (control) (b) warm-up + SS (c) warm-up + DS	(a) 20 m Sprint run test (b) CMJ height	SS significantly decreases sprinting and CMJ in adolescents, whereas DS decrease explosive power but has no effect on

Authors	Subjects	DS Treatment	Criteria	Results
Pearce et al. (2009)	13 participants	(a) Warm-up + VJ / SS + VJ / movement activity warm-up + jump test (b) Warm-up + VJ; DS + VJ / movement activity warm-up + jump test (c) Warm-up + VJ; Control + VJ / movement activity warm-up + jump test up to 60 min post activity.	VJ height	sprinting performance. Significant difference of 10.7% in VJ height between SS and DS after the intervention. Significant increase in VJ height after second warm-up for DS but no difference for SS.
Perrier et al. (2011)	21 recreationally active male university students	(a) Warm-up + no stretching (b) Warm-up + SS	(a) Sit and reach (flexibility) (b) CMJ height (c) reaction time	No difference in flex between warm-up + SS and warm-up + SS but greater than warm-up + no stretching for both. CMJ

Authors	Subjects	DS Treatment	Criteria	Results
		(c) Warm-up + DS		height is greater in DS>SS>NS.
Sekir et al. (2010)	10 female subjects	(a) Control (b) SS (c) DS	(a) concentric/eccentric peak torque of the leg extensor and flexors at 60°/s and 180°/s (b) EMG of hamstrings and quadriceps muscles	Significant decrease in strength and EMG RMS amplitude after SS. Significant increase in strength and EMG RMS amplitude after DS at both speeds.
Taylor et al. (2009)	13 netball players	(a) SS (15 min) (b) DS (15 min)	(a) CMJ height (b) 20 m sprint	Significant decrease in CMJ height (-4.2%) after SS compared to after DS. Significant increase in sprint time (+1.4%) after SS when compared to after DS.

Authors	Subjects	DS Treatment	Criteria	Results
Torres et al. (2008a)	11 male track and field athletes	(a) Control (b) SS (c) DS (d) SS + DS	(a) 30% of 1RM bench throw (b) Isometric bench press (c) overhead medicine ball throw (d) lateral medicine ball throw (Depending on the exercise, test peak power (P_{max}), peak force (F_{max}), peak acceleration (A_{max}), peak velocity (V_{max}), and peak displacement (D_{max}))	Depending on exercise. For P_{max} , F_{max} , A_{max} , V_{max} , and D_{max} there was no significant difference. However, D_{max} for SS +DS was significantly larger.
Turki et al. (2011)	20 athletes	(a) DS + concentric (DS/CON): 3x3RM deadlift exercise	CMJ at 15 s, 4, 8, 12, 16 and 20 min.	The DS and DS/CON protocols had a 95-99% exceeding the smallest worthwhile change for the

Authors	Subjects	DS Treatment	Criteria	Results
Van Gelder and Bartz (2011)	60 male subjects (18 collegiate and 42 recreational athletes)	sprint + ADS3 (ADS x 3) (a) warm up + rest +SS (b) warm up + rest +DS (c) Control + rest	Agility run time	Significant faster times on the agility test for DS than SS and control group. No significant difference between SS and control group.
Vetter (2007)	26 active subjects (14 males and 12 females)	(a) walk + run (WR) (b) WR + exercises with small jumps (EJ) (c) WR + dynamic active stretching + EJ (DAEJ) (d) WR + dynamic active stretching (DA) (e) WR + SS + EJ	(a) 30 m sprint run time (b) CMJ height	No significant difference in sprint performance. Significant decrease of JH in all groups. JH in WR was significantly greater than in WR+SS ($p = 0.003$), and JH was significantly higher in DAEJ than WR +SS ($p = 0.009$) in CMJ height.

Authors	Subjects	DS Treatment	Criteria	Results
		(SSEJ)		
		(f) WR + SS		
Wallmann, Christensen, Perry, and Hoover (2012)	25 healthy recreational runners	(a) warm-up + 40-yrd sprint + self-pace walk + BS + 40-yrd sprint	40-yard sprint time	Improvement in sprint time only in the control condition.
		(b) warm-up + 40-yrd sprint + self-pace walk + DS + 40-yrd sprint		
		(c) warm-up + 40-yrd sprint + self-pace walk + SS + 40-yrd sprint		
		(d) warm-up + 40-yrd sprint + self-pace walk + NS + 40-yrd sprint		
Werstein and Lund (2012)	15 female rugby & soccer	(a) warm-up only (WO)	(a) reactive strength index	DS resulted in significantly

Authors	Subjects	DS Treatment	Criteria	Results
	players	(b) warm-up + SS (c) warm-up + DS	test (b) contact time (c) flight time	greater RST and FT compared with SS and WO. No significant effect on CT.
Yamaguchi and Ishii (2005)	11 male college students	(a) SS (b) DS (c) NS (Control)	Leg extension power	Significant increase in leg extension power after DS but no significant difference after SS and control.
Yamaguchi et al. (2007)	12 male students	(a) DS (b) No stretching (NS) (control)	(a) 5% MVIC torque (b) 30% MVIC torque (c) 60% MVIC torque	Significant increase in power output of the knee extensors after the DS than the SS treatment.

Note. SS = Static stretching, DS = Dynamic stretching, PT = peak torque; CMJ = countermovement jump; DP = drop jump; SJ = squat jump; MVIC = maximal voluntary isometric contraction; RMS = root mean square, MVC = maximal voluntary contraction

Agility, Balance and Response Time

Compared to strength, power and speed, relatively little research has investigated the effect of stretching on aspects of motor control. Agility is defined as a rapid whole-body movement with change of running direction in response to a stimulus (Van Gelder & Bartz, 2011). Regarding agility test times, dynamic stretching compared to static stretching has been found to produce faster 505 agility test, Balsom agility test, Zig-Zag agility, Illinois agility test times, T-drill and shuttle run (Amiri-Khorasani et al., 2010; Fletcher & Monte-Colombo, 2010a; Little & Williams, 2006; McMillian et al., 2006; Pearce et al., 2012; Van Gelder & Bartz, 2011). On the contrary, Faigenbaum et al. (2006) and Chaouachi et al. (2010) attributed the lack of significant differences in their studies to the recovery interval between stretching and testing. Additionally, Faigenbaum et al. (2006) used school-aged children (15.5 ± 0.9 years) who may vary in their developmental stage of growth, and the intensity and duration of the warm-up protocols introduced could explain the variance observed in comparison to the other studies findings.

Regarding balance, only two studies investigated the effect of dynamic stretching on balance (Belkhiria-Turki et al., 2014; Chatzopoulos, Galazoulas, Patikas, & Kotzamanidis, 2014). Maintaining balance requires fast and accurate movements of upper and lower extremities. Stretch-induced changes to the muscle-tendon unit length and stiffness would be expected to affect the ability to react effectively to stability challenges (Behm, Bambury, Cahill, & Power, 2004). Chatzopoulos et al. (2014) found better performance of dynamic stretching compared to static stretching during a balance test performed on a stability platform, whereas Belkhiria-Turki et al. (2014) observed no substantial effects of 4, 8 or 12 sets (1, 2 or 3 min) of dynamic stretching or static stretching of individual muscle groups on the star excursion balance test. An explanation for the better balance performance of dynamic stretching compared to static stretching in Chatzopoulos et al. (2014) study is that dynamic stretching elevates muscle temperature (Fletcher & Jones, 2004) and stimulates the nervous system (Jaggers et al., 2008). Mann and Jones (1999) suggested that the key attributes of dynamic stretching include enhanced motor unit excitability and improved kinaesthetic sense, leading to improved proprioception and pre-activation. Herda et al. (2008) reported that

dynamic stretching increased EMG amplitude which may reflect a positive effect of dynamic stretching on muscle activation. As the star excursion balance test in Belkhiria-Turki et al. (2014) involves slow, deliberate movements compared to the fast-dynamic movements in the dynamic stretching protocol, star excursion balance test may not be the appropriate balance test for activities that involve rapid or powerful movements.

Ayala et al. (2014) investigated the effects of dynamic stretching and static stretching on response time (time interval from the application of the auditory (dynamometer) and visual (trigger box) stimulus to the development of torque) (Winter & Brookes, 1991), pre-motor time (time between the initial stimuli and the onset of muscle activation) (Zhou, Lawson, Morrison, & Fairweather, 1995) and motor time (EMD) (time interval between the onset of EMG activity and torque development required to initiate an overt response) (Zhou et al., 1995). The results suggest that both dynamic stretching and static stretching do not influence hamstrings response times. Additionally, Perrier et al. (2011) found no significant effects of dynamic stretching and static stretching on reaction time using a visual stimulus. Curry et al. (2009) observed no significant changes for the isometric time to peak force knee extension using dynamometry although there was a decrease in the time to peak force from pre-test to 5 and 30 min post-test in 24 recreationally active women.

Endurance - Running Economy

One of the factors that affect endurance performance is exercise efficiency or running economy. Distance runners who have greater running economy (rate of oxygen consumption per unit body mass when running at a given speed (Cavanagh & Kram, 1985; Daniels, Yarbrough, & Foster, 1978; Williams & Cavanagh, 1987) will have a competitive advantage (Saunders, Pyne, Telford, & Hawley, 2004). A variety of training interventions have been investigated to try and improve an individual's running economy, such as plyometrics (Saunders et al., 2006; Spurrs, Murphy, & Watsford, 2003; Turner, Owings, & Schwane, 2003), strength and resistance training (Barnes et al., 2013; Ferrauti, Bergemann, & Fernandez-Fernandez, 2010;

Guglielmo, Greco, & Denadai, 2009; Johnson, Quinn, Kertzer, & Vroman, 1997; Jung, 2003; Paavolainen, Hakkinen, Hamalainen, Nummela, & Rusko, 2003; Storen et al., 2008), interval training (Barnes et al., 2013; Denadai, Ortiz, Greco, & de Mello, 2006; Franch, Madsen, Djurhuus, & Pedersen, 1998; Slawinski, Demarle, Koralsztein, & Billat, 2001) and altitude training (Saunders, Telford, & Pyne, 2004; Saunders, Telford, Pyne, Hahn, & Gore, 2009).

The proposed determinants for running economy are varied from anthropometric to biomechanical parameters (Saunders, Pyne, et al., 2004). The mechanisms proposed accounting for inter-individual differences or intra-individual improvements in running economy depend on which training has been applied to the study population. As a result, there are several proposed mechanisms for the improvement of running economy, such as: muscle fibre distribution (Kaneko, 1990; Kyröläinen et al., 2003), myosin heavy chain composition (Kyröläinen et al., 2003), economical movement patterns (Williams & Cavanagh, 1987) and neuromuscular activation that can affect efficient storage and release of elastic energy (Jones, 2002; Kyröläinen, Belli, & Komi, 2001) or co-activation of muscular activity (Heise, Shinohara, & Binks, 2008). Also, the choice or lack of footwear can influence running economy by primarily altering the running mechanics of the individual (Nigg & Enders, 2013).

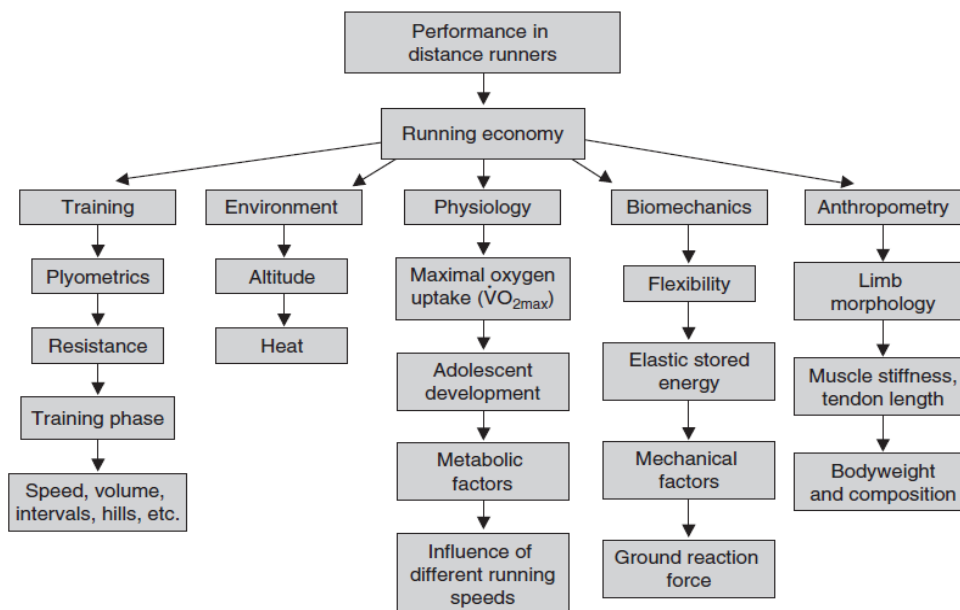

Figure 2.13. Factors affecting running economy. From “Factors Affecting Running Economy in Trained Distance Runners,” by P. Saunders, D. Pyne, R. Telford, and J. Hawley, 2004, *Sports Medicine*, 34 (7), p.470. Copyright 2004 by Adis Data Information BV.

Additionally, one of the many factors that can affect running economy is flexibility (Saunders, Pyne, et al., 2004). There appear to be contradictory results regarding the effects of stretching on running economy (Barnes & Kilding, 2015b). Current evidence suggests that there is an inverse relationship between flexibility and running economy; that is less flexibility is associated with better running economy (Craib et al., 1996; Gleim & Nicholas, 1990; Hunter et al., 2011; Jones, 2002; Trehearn & Buresh, 2009). This strong relationship is evident in both elite ($r = 0.68$) (Jones, 2002) and trained endurance runners ($r = 0.83$) (Trehearn & Buresh, 2009). Gleim and Stachenfeld (1990) tested 100 male and female subjects over a range of speeds from 3 to 12 km/h and found that the less flexible ones (in a battery of 11 trunk and lower limb flexibility tests) were more economical.

This suggests that the inflexibility of the lower limb and trunk musculature as well as limited ROM around the joints of the lower body allow for greater elastic energy storage and use in the muscles and tendons during the running (Gleim & Nicholas, 1990; Jones, 2002) considering that as much as 40-50% of the energy

needed for distance running can be obtained from the elastic ability of skeletal muscle (Cavanagh & Kram, 1985). Inflexibility in the transverse and frontal planes of the trunk and hip regions of the body may stabilise the pelvis at the time of foot impact with the ground, reducing the excessive ROM and metabolically expensive stabilising muscular activity (Gleim & Nicholas, 1990). Greater muscle-tendon unit stiffness in some muscle groups is associated with increased running economy (Arampatzis et al., 2006). Runners with stiffer musculotendinous structures store more elastic energy in their lower limbs, reducing the work done by the contractile element during the propulsion phase (Alexander & Bennet-Clark, 1977; Roberts, 1997) resulting in a lower rate of oxygen uptake ($\dot{V}O_2$) at submaximal running velocities (Barnes, Mcguigan, & Kilding, 2014; Craib et al., 1996; Gleim & Nicholas, 1990; Jones, 2002).

Nevertheless, other research fails to support the existence of an inverse relationship, arguing that flexibility is an essential component of distance running performance (Beaudoin & Whatley Blum, 2005; Godges, MacRae, Longdon, Tinberg, & Macrae, 1989; Godges, MacRae, & Engelke, 1993; A. Nelson, Kokkonen, Eldredge, Cornwell, & Glickman-Weiss, 2001). Godges et al. (1989) found improved running economy at workloads equivalent to 40, 60 and 80% maximal oxygen uptake ($\dot{V}O_{2max}$) in response to static stretching after 12 minutes of treadmill running (4 min at each speed) in a study limited to 7 moderately trained athletic male college students with limited ROM in hip flexor and/or extensor muscles. A reduced aerobic demand of running at all speeds was reported when hip flexion and extension were increased (Godges et al., 1989).

Methodological limitations in the study design such as no employment of an adequate treadmill accommodation period (Gleim & Nicholas, 1990; Godges et al., 1993; Jones, 2002) familiarization with treadmill running (Craib et al., 1996), population not described as runners of any caliber (Gleim & Nicholas, 1990; Jones, 2002; A. Nelson, Kokkonen, et al., 2001), and use of both males and females as participants (Gleim & Nicholas, 1990; A. Nelson, Kokkonen, et al., 2001; Trehearn & Buresh, 2009) since females are generally more flexible (Trehearn & Buresh, 2009) and less economical than males (Daniels & Daniels, 1992) may have affected the results. In addition, running economy was only measured immediately post-

stretching, and follow-up measures were not performed (Bonacci, Chapman, Blanch, & Vicenzino, 2009).

Further research that failed to find an association between flexibility and running economy has shown that a static stretching protocol (Allison, Bailey, & Folland, 2008; Hayes & Walker, 2007; Mojock, Kim, Eccles, & Panton, 2011) does not change running economy, but results in improvement in sit-and-reach test flexibility. However, one reason that running economy may not have been affected by static stretching is that the authors measured running economy during the final stages of the run (Carter & Greenwood, 2015). Allison et al. (2008) measured running economy and energy expenditure during the 3- to 10-minute period of a 10-minute run at 70% of their aerobic capacity, whereas Hayes and Walker (2007) using static stretching, progressive static stretching and dynamic stretching measured running economy during the last 3 minutes of a 10-minute run. Recent results suggest that runners should be advised against performing static stretches immediately prior to running, as it can, in fact, be detrimental to performance and energy cost (Lowery et al., 2014; J. Wilson et al., 2010). Performing static stretching before exercise causes a decrease in muscle-tendon unit stiffness (J. Wilson et al., 2010), causing an increase in the slack of the muscle-tendon unit, which is referred to as creep deformation. An increase in muscle-tendon unit stiffness allows for the optimal transmission of the internal forces created by the muscle-tendon unit, and muscle-tendon unit stiffness improves running economy (Arampatzis et al., 2006). It is agreed that one of the reasons plyometric and resistance training improves running economy is due to an increase in muscle-tendon unit stiffness (Carter & Greenwood, 2015). A decrease in muscle-tendon unit stiffness created from acute static stretching can negatively affect force transmission by altering the viscoelastic properties of the muscle which will reduce running economy, impair running performance and increase ground contact time (Carter & Greenwood, 2015).

Less is known about the effects of dynamic stretching on running economy. Hayes and Walker (2007) compared the acute effects of dynamic stretching of the lower extremities for two sets of 30 s and non-stretching on $\dot{V}O_2\text{max}$ during treadmill running for 10 minutes at an intensity of 75% $\dot{V}O_2\text{max}$. They found that slow velocity dynamic stretching did not acutely change running economy during treadmill running

at an intensity of 75% $\dot{V}O_2$ max in well-trained runners. The authors attributed the no change in performance to the fact that running economy has been assessed after a period of submaximal running since previous studies employing maximal or near-maximal exercise have found a reduction in performance.

In contrast, Zourdos, Wilson, and Sommer (2012) studied how dynamic stretching affected male runners over a 60-minute run. The researchers found that dynamic stretching in the lower extremities was associated with a statistically significant acute increase in the energy (caloric) expenditure during treadmill running for 30 minutes at an intensity of 65% $\dot{V}O_2$ max compared to the non-stretching condition, with no difference in maximal distance covered between the dynamic stretching (10 different exercises, two sets of four repetitions lasting 15 minutes) and control (non-stretching) conditions although a transient increase in maximum ROM was observed. The dynamic stretching raised the subjects' heart rate, $\dot{V}O_2$, and metabolism before the run which are characteristics of a proper dynamic warm-up (Carter & Greenwood, 2015). However, it has been suggested that this increase in the temperature and metabolic demand may not be beneficial to endurance performance (Bishop, 2003a). Furthermore, if the warm-up intensity and duration are too high or >10 minutes, respectively, the warm-up can be detrimental to performance (Bishop, 2003b). Additionally, it can be hypothesised that the dynamic stretching could have significantly increased endurance performance compared with control if the performance run was not preceded by the 30-minute preload run. The pre-load run acted as a dynamic warm-up by itself.

A recent study by Yamaguchi and Takizawa (2015) investigated the effects of dynamic stretching (one set of 10 repetitions at 30 beats/minute (0.5 Hz)) at a velocity equivalent to 90% $\dot{V}O_2$ max. The results indicated that dynamic stretching acutely prolonged the time to exhaustion and extended the total distance of endurance running. Yamaguchi and Takizawa (2015) considered that the differences between the findings in these 3 studies are attributed firstly to the different dynamic stretching protocols between them and secondly to the differences in the exercise intensities during performance assessment. However, it is not known whether muscle-tendon unit stiffness or improvement in neuromuscular activation was altered by dynamic stretching and caused the above effects. It is hypothesized

that a dynamic warm-up will increase flexibility due to an increase in muscle compliance, whereas static stretching promotes an increase in flexibility due to a decrease in muscle-tendon unit stiffness, causing an increase in the slack of the muscle-tendon unit caused by muscle and tendon creep, which impairs subsequent performance (Carter & Greenwood, 2015).

Saunders, Pyne, et al. (2004) suggest that there is an optimal level of flexibility whereby one can benefit. Similarly, Nelson et al. (2001) proposed that there may be a certain threshold or percentage change in flexibility that needs to be reached before improvements in running economy would be found. Previous studies have only looked at manipulating the level of flexibility and monitoring running economy, but have not looked at whether a training intervention affects the muscle or the tendon structure. It must also be acknowledged that studies tend to focus on hip and/or thigh flexibility, with very few investigating calf flexibility even though it undergoes great tensile stress and is the primary plantarflexor muscle contributing to the push-off phase of running (Kibler, Goldberg, & Chandler, 1991).

Researchers suggest that if individuals are less flexible then they have a more efficient elastic energy storage in their muscles and tendons during the eccentric, absorption phase of ground contact, and thus, more elastic energy can be released during the concentric, propulsive phase of ground contact (Jones, 2002). This storage and release of elastic energy by the muscle and tendons is known as the SSC (Komi, 1984).

Involvements of other muscular mechanisms which can be affected by stretching to running economy are also discussed by several authors. The elastic nature of the muscle has an important influence on the SSC. The SSC consists of three phases: pre-activation, high-velocity eccentric contraction followed immediately with a concentric contraction. The primary purpose of SSC of muscle function is to enhance the performance of the final phase, the concentric contraction (Nicol, Avela, & Komi, 2006), and the increase in preparatory muscle activity was suggested to be a mechanism to improve running economy (Kyröläinen et al., 2001). The SSC ultimately helps achieve a greater concentric force production in the muscles, compared to a purely concentric action (Komi, 2000). Additionally, the eccentric contractions during which elastic energy is stored are less costly than the concentric

contractions in which the energy is released (Williams, 1985) making a substantial contribution to propulsion as it is released during subsequent concentric contractions (Aruin, Prilutskii, Raitsin, & Savel'ev, 1979; Cavagna & Kaneko, 1977). Abe, Muraki, Yanagawa, Fukuoka, and Niihata (2007) demonstrated that a greater ratio of eccentric to concentric vastus lateralis muscle EMG activity was associated with lower metabolic demand during running (better running economy).

Performing a one-mile run after a static stretching protocol resulted in higher muscular activity of the gastrocnemius muscle (Lowery et al., 2014). This was due to the motor units being placed in a fatigued state from the static stretching, thus more muscular recruitment was necessary to perform the task (Lowery et al., 2014). Considering that one of the adaptations to endurance training is the asynchronous recruitment of the musculature, having to recruit more muscle fibres per given intensity would be counterproductive to performance for distance running (Carter & Greenwood, 2015). Efficiency, and potentially running economy, is believed to be greatest when runners are less flexible, as this can lead to the muscle-tendon unit being stiffer and therefore it can yield a greater amount of stored energy (A. Nelson, Kokkonen, et al., 2001).

Leg stiffness can be modulated by neuromuscular activation, and changes in stiffness have been shown to occur as a result of neuromuscular adaptation to training (Franklin, Burdet, Osu, Kawato, & Milner, 2003) as discussed above. Greater duration of muscle co-activation of bi-articular leg muscles during the stance phase has also been significantly associated with better running economy (Heise et al., 2008) while Moore, Jones, and Dixon (2014) contradicted the work of Heise et al. (2008) by finding that longer co-activation during running may be potentially detrimental to performance due to higher metabolic cost. Methodological differences may be responsible for the opposing findings. Heise et al. (2008) required participants to run at a self-select speed based on perceived effort level, whereas participants were required to run at standardized speeds during Moore et al. (2014) study. Kuitunen, Komi, and Kyröläinen (2002) argued that participants' effort levels are different at standardized speeds and this affects their neuromuscular requirements (Stirling, von Tscherner, Kugler, & Nigg, 2011). However, they did not assess the metabolic cost of running in relation to running mechanics. Furthermore,

the speeds chosen in Moore et al. (2014) were representative of the participants' training speeds, meaning they were familiar with each test speed used. Muscle co-activation modulates leg stiffness during running and may alter running economy through utilisation of stored elastic energy, which has no additional metabolic cost (Barnes & Kilding, 2015a). Albracht and Arampatzis (2013) indicated that increased tendon stiffness is indicative of greater energy storage and return and a redistribution of muscular output within the lower extremities while running, which might result in improved running economy.

Prevention of Injury

Among athletes and coaches, a low level of flexibility and a high level of muscle-tendon unit stiffness are thought to be risk factors for muscle-tendon unit injury (Small, Mc Naughton, & Matthews, 2008). Subsequently, pre-activity stretching that transiently increases flexibility and reduces muscle-tendon unit stiffness is believed to prevent injuries (Shehab, Mirabelli, Gorenflo, & Fetters, 2006; Small et al., 2008). A distinction should be made between the effects of an acute bout of stretching on injury risk in the subsequent training session or competition, versus the effects of stretch (flexibility) training over a period of weeks or month, the timing of which could occur before or after training sessions or even in separate sessions on the same or different days (Hutton, 1992; Shrier, 2005). This section will consider the effects of an acute bout of stretching on injury risk in the subsequent training session or competition.

Most muscle strain injuries occur during eccentric contraction in the normal ROM (Thacker et al., 2004) but muscles may be more vulnerable to injury during eccentric contractions at long muscle lengths (McHugh & Cosgrave, 2010). Fast, strong eccentric contractions that are part of a SSC may impose particular stress on the muscle-tendon unit, particularly tendons (Witvrouw, Mahieu, Roosen, & McNair, 2007). Eccentric contractions produce the greatest force compared to isometric and concentric contractions, and eccentric force increases and then plateaus as the velocity of lengthening increases (Lieber, 2010), therefore actions with fast, strong

eccentric contractions (e.g. jumping, sprinting, changing direction while sprinting) are most likely to produce muscle strains.

Injuries to the hamstring muscles are common to running and jumping sports and have been associated with a low eccentric strength of the muscle group (Petersen & Hölmich, 2005). Another way to look at this effect is in terms of the hamstrings to quadriceps (H:Q) strength ratio. A lower H:Q ratio translates into a higher injury risk. Costa et al. (2014) examined if dynamic stretching could acutely improve H:Q ratio by increasing the strength of the hamstrings, which would translate into lowering the injury risk. Conventional H:Q ratio was calculated as the maximal concentric peak torque of the hamstrings divided by the maximal concentric peak torque of the quadriceps. Functional H:Q ratio was calculated as the maximal eccentric peak torque of the hamstrings divided by the maximal concentric peak torque of the quadriceps. After dynamic stretching, hamstrings experienced a deficit in peak torque both concentrically and eccentrically, while the quadriceps had no change in peak torque, both versions of the ratio declined, therefore making, this dynamic stretching protocol associated with an increase in injury risk.

The authors speculated that this decrease in strength may be similar to the stretch-induced deficit caused by static stretching and that the strength decreases in this study may be attributed to a decrease in the musculotendinous stiffness due to the resulting increase in electromechanical delay (Costa et al., 2014). A stretch-induced increase in slack allows more force to be lost within the musculotendinous unit rather than be applied by the tendon to the bone to cause movement. The final result may be a decrease in performance and an elevated risk of injury for activities such as running or kicking (Koziris, 2015). A decrease in resting muscle stiffness is associated with greater injury risk in animal muscles (Shrier, 1999). However, it can be argued that the dynamic stretching targeting the quadriceps did not have an effect on the quadriceps muscles, thereby leading to the greater imbalance as seen in the ratios (Koziris, 2015).

Ayala et al. (2013) found no dynamic stretching-related changes in H:Q ratios, conventional, functional and co-contraction ratio (by dividing eccentric hamstrings torque by concentric quadriceps torque at the same joint angle where the concentric quadriceps peak torque was generated for both of these actions). Hence, they

concluded that dynamic stretching did neither reduced nor increased eccentric strength or muscle imbalance, two primary factors of muscle injury. Two of the limitations of the study are firstly it is not clear whether there are changes in resistance/stretch tolerance due to the dynamic stretching protocol since there was no measurement of the changes in ROM or changes in resistance/stretch tolerance due to the dynamic stretching protocol, and secondly whether any changes in the muscle-tendon unit stiffness had occurred. Also, another difference between two studies is that Ayala et al. (2013) used both male and female participants while Costa et al. (2014) used only females.

Interestingly, it has been questioned whether decreased stiffness of a relaxed muscle-tendon unit (or increased maximum ROM) is even relevant to injury risk since most muscle strain injuries occur in active muscles undergoing forced stretch (eccentric contractions) (Thacker et al., 2004). More relevant would be muscle compliance/stiffness during contraction, which is determined by the number of attached myosin cross-bridges. In contrast, resting muscle compliance is determined by the compliance of the cytoskeleton, intramuscular connective tissue, and tendon (Shrier, 1999, 2005).

Another mechanism which might be contributing to the prevalence of injury is the neuromuscular reaction time, also known as electromechanical delay (EMD), which has been defined as the time delay between the onset of muscle activity and the onset of force generation associated with the response (Norman & Komi, 1979; Vos, Harlaar, & van Ingen Schenau, 1991; Zhou, McKenna, Lawson, Morrison, & Fairweather, 1996). EMD and peak force are considered very important for the function, performance, and protection against neuromuscular injuries. Accordingly, their potential impairment or enhancement under stretching has also been a cause of concern (Gleeson, Minshull, Eston, & Bailey, 2008; Minshull, Eston, Bailey, Rees, & Gleeson, 2014).

The EMD is attributed to the following structures and mechanisms: (a) the propagation of the action potential along the excitable muscle; (b) the excitation-coupling process; and (c) the series elastic component by the contractile element (Alexander & Bennet-Clark, 1977; Cavanagh & Komi, 1979; Sandow, 1965). However, it is suggested that the elongation of the SEC of the musculotendinous unit

may account for the lengthening of the EMD (Cavanagh & Komi, 1979) and that there may be an inverse relationship between the EMD and musculotendinous stiffness (Grosset, Piscione, Lambertz, & Pérot, 2008). Consequently, EMD can offer great insights into the function of the neuromuscular and musculoskeletal performance of a joint (Baltzopoulos & Gleeson, 2001; Gleeson, 2001). Isabelle, Sylvie, and Chantal (2003) argued that a change in EMD might be an indirect indication of muscle stiffness and tone, and therefore an important factor in accessing joint stability. Subsequently, an increased EMD due to increased compliance of the muscle-tendon unit may predispose an individual to injury by reducing joint stability in response to perturbation.

Furthermore, an acute bout of stretching may temporarily reduce the force producing capabilities of a muscle. This diminished force-producing capability is termed 'the stretching-induced force deficit' (Avela et al., 1999; Behm, Button, & Butt, 2001; Costa et al., 2009; Fowles et al., 2000; Kokkonen, Nelson, & Cornwell, 1998). This has been attributed to two main hypothesis: (a) neural factor such as a decrease in muscle activation (Avela, Finni, Liikavainio, Niemelä, & Komi, 2004; Guissard & Duchateau, 2006), (b) changes in the structural and functional characteristics of the muscle-tendon unit, and affect the transmission of force (Kubo et al., 2001b; Ryan et al., 2008; Weir et al., 2005). Ayala et al. (2014) in the only study investigating dynamic stretching effect on hamstring EMD used eccentric contractions to mimic the mechanism of anterior cruciate ligament (ACL) injury (Barry, Scott, John, & William, 2000). During dynamic sports activities where the ACL is overload, the hamstrings are eccentrically activated to act as synergists to improve the knee stability and successfully absorb the external forces generated (McLean, Huang, & van den Bogert, 2008; H. Smith et al., 2012). The results of this study suggest that dynamic stretching does not influence hamstring response time neither suggest that dynamic stretching reduces the primary risk factor (response time) for ACL injury.

No study has investigated the effect of dynamic stretching on joint position sense and force matching task up to date.

Proposed Physiological Mechanisms for improved performance after Dynamic Stretching

Unlike static stretching, dynamic stretching is nowadays recommended as a pre-performance routine. However, there is little knowledge regarding the underlying mechanisms of stretch-induced performance enhancement and increase in the ROM. Mechanisms are suggested to be neural, mechanical and peripheral in nature.

Rehearsal of Movement

It is speculated that dynamic stretching enhance performance due to specific movement rehearsal, improved proprioception, and pre-activation (Fletcher & Jones, 2004; Young & Elliott, 2001), allowing an optimum switch from the eccentric to concentric muscle contraction that was required to generate high running speeds but also to enhance muscle-tendon unit stiffness and increased coordination of dynamic movement observed (Behm & Chaouachi, 2011). Fletcher (2010) demonstrated an increase in jump performance using two different dynamic stretch velocities. The fast-dynamic stretching had a greater improvement in jump performance than the slow dynamic stretching. Additionally, the magnitude of the myotatic reflex is related to stretching velocity (Gollhofer & Rapp, 1993; Gottlieb & Agarwal, 1979). With increasing dynamic stretching speed, greater action potential of the myotatic reflex may result, increasing muscle-tendon unit stiffness, helping to explain the increased running speeds (Fletcher & Jones, 2004; Siatras & Papadopoulos, 2003).

Other authors parallel this notion in that a dynamic stretching session may enhance performance with sport-specific movement patterns via facilitated motor unit control.

Heart Rate, Muscle and Core temperature

Improvements in muscular performance after dynamic stretching are likely due to the associated voluntary contraction of the dynamic stretching protocol.

Muscles are actively and rhythmically contracting during the dynamic stretching, therefore dynamic stretching may help in the warm-up process, increasing heart rate and core and muscle temperature (Fletcher, 2010; Fletcher & Monte-Colombo, 2010a, 2010b; Herda et al., 2008; Yamaguchi & Ishii, 2005).

Changes in core temperature were significantly greater in the two dynamic stretch conditions compared to the control condition (Fletcher & Jones, 2004). These changes in the core temperature observed in the dynamic stretching may be an indirect indicator of local muscular changes in temperature that are consistent with a general warm-up. Additionally, Fletcher and Monte-Colombo (2010b) reported increased heart rate and core temperature after dynamic stretching than static stretching and no stretching.

Neural Adaptations

The increase in EMG amplitude after dynamic stretching suggests that neuromuscular mechanisms may be responsible for the enhanced muscular performance. The increase in muscle temperature, heart rate, vasodilation, muscle blood flow and decreased resistance of muscles and joints to movement as a result of dynamic stretching may induce a more forceful and rapid muscle contraction by increasing the transmission rate of nerve impulses and sensitivity of nerve receptors (Fletcher & Jones, 2004; Shellock & Prentice, 1985; Yamaguchi & Ishii, 2005; Yamaguchi et al., 2007) and the force generating capacity of the muscle cells (Stienen, Kiers, Bottinelli, & Reggiani, 1996), positively affecting the force-velocity relationship.

Increased EMG activity in fast- dynamic stretching intervention (100 beats/min), and no changes in slow dynamic stretching intervention (50 beats/min) was found (Fletcher, 2010), the increase in EMG activity was attributed to greater motor unit activation. Indeed, several studies (Fletcher, 2010, 2013; Herda et al., 2008; Holt & Lambourne, 2008; Hough et al., 2009; Pearce et al., 2009) have identified an increase in neuromuscular activation as a mechanism for improvement in performance due to dynamic stretching. Studies evaluating drop jumps and countermovement jumps (Fletcher, 2010, 2013; Holt & Lambourne, 2008; Pearce et

al., 2009) have shown an increase in performance following dynamic stretching suggesting a preservation of muscle-tendon unit stiffness. Wilson et al. (1994) hypothesised that a stiff muscle-tendon unit can enhance force production by altering the force-velocity and length-tension relationships, enhancing force transmission.

Post-Activation Potentiation

Another possible mechanism is that neuromuscular phenomena elicited from a dynamic stretch are contributing factors that lead to increased muscle power. Two of these mechanisms include post-activation potentiation (PAP) (Fletcher, 2013; Hough et al., 2009; Torres et al., 2008) and post-contraction sensory discharge. Post-activation potentiation is an increase in muscle twitch and low-frequency tetanic force following contractile activity, initiated through the use of a conditioning activity (Sale, 2002) or simply PAP can be defined as an increase in the efficiency of the muscle to produce force after a submaximal or maximal voluntary contraction (Chatzopoulos et al., 2007). The mechanism for PAP requires an increase in motor unit recruitment to lift the heavy loads performed in the pre-exercise activity. Similarly, the increased neural activity in dorsal spinal roots after muscular contractions (i.e. post-contraction sensory discharge) may lead to a more rapid and forceful response from the muscle being activated (Enoka, 2015; McMillian et al., 2006).

The primary mechanism responsible for PAP is an increase in phosphorylation of myosin light chain, which enables the actin-myosin interaction to become more sensitive to Ca^{2+} that is released from the sarcoplasmic reticulum leading to an increased actin-myosin cross-bridge formation rate (Sale, 2004). Increased sensitivity to Ca^{2+} has the greatest effect at low myoplasmic levels of Ca^{2+} , thereby improving muscular performance (Sale, 2002). Greater muscle activation is due to a greater duration of calcium ions availability in the muscle cell environment and thus the greater the phosphorylation of the light chain myosin (Rixon, Lamont, & Bemben, 2007) resulting in faster contraction rates i.e. shortening the time to peak torque, faster rates (Chiu et al., 2003) and increased rate of torque development (Sale, 2002). Post-PAP performance enhancement has been associated with

enhanced motor unit excitability (Hamada, Sale, MacDougall, & Tarnopolsky, 2000), increased motor unit recruitment and synchronisation, decreased presynaptic inhibition, or greater central activation of the motor neuron (Aagaard, Simonsen, Andersen, Magnusson, & Dyhre-Poulsen, 2002).

Also, the ability to improve performance via PAP has been attributed to the recruitment of a high number of type II skeletal muscle fibres (fast-twitch muscles) during dynamic than static contractions (Hamada et al., 2000) and strength and skill level (Gourgoulis, Aggeloussis, Kasimatis, Mavromatis, & Garas, 2003; Hamada et al., 2000; J. Smith & Fry, 2007). If dynamic stretching is performed faster, there will be an increase in the recruitment of type II fibres, leading to an increase in neuromuscular activation measured by EMG since fast-twitch muscles show higher potentiation than slow-twitch muscles (Güllich & Schmidtbleicher, 1996; Hamada et al., 2000). Yamaguchi and Ishii (2005) and Yamaguchi et al. (2007) hypothesised that the increased force output after dynamic stretching was the result of an enhancement in neuromuscular function, and they suggested from their results that PAP might have occurred.

The secondary mechanism that has been proposed is that the magnitude of the myotatic reflex is related to stretching speed (Gollhofer & Rapp, 1993). It has been suggested that increasing the Hoffmann reflex (H-reflex) amplitude by increasing stretching speed, as demonstrated in dynamic stretching and movement activity (Fletcher & Anness, 2007; Gollhofer & Rapp, 1993) leads to the recruitment of higher order motor units, subsequently causing greater muscle force production (Güllich & Schmidtbleicher, 1996). This has been found to be present during fast concentric muscle actions at high stimulation frequencies (Abbate, Sargeant, Verdijk, & de Haan, 2000). The generation of greater concentric force produced in a short time interval can enhance the ability of the athlete to accelerate at the beginning of the sprint and overcome the resistance provided by bodyweight in serving to improve sprint performance (Mero, Komi, & Gregor, 1992). The increase in concentric force during sprint running is highly likely to be because of an increase in muscle-tendon unit stiffness attributable to an increase in a stretch-induced reflex response. This increase in the muscle stiffness enables elastic energy storage in the series elastic component, especially the tendon (Blazevich, 2011). This energy stored in the

tendon is used during tendon recoil at very high speeds and with a large restoring force to amplify power output producing explosive forceful movement (Blazevich, 2011; Kubo, Kanehisa, Kawakami, & Fukunaga, 2001c).

Muscle-Tendon Unit Stiffness

One other possible mechanism for the increased joint ROM after dynamic stretching is a decrease in muscle-tendon unit stiffness. Herda et al. (2013) used a fourth-order polynomial regression model that was fitted to the passive-torque angle curves for each participant. Passive resistive torque and passive muscle-tendon unit stiffness decreased following 2 min of dynamic stretching. Recently, some authors (Mizuno, 2017; Mizuno & Umemura, 2016) used ultrasonography combined with dynamometry to assess stiffness after dynamic stretching. These two studies did not reveal any change in passive ankle muscle-tendon unit stiffness, as the ankle was passively dorsiflexed to its maximal dorsiflexion angle and passive resistive torque at different joint angles (at 1°, 5°, 9° and 13°) after four sets (Mizuno & Umemura, 2016) and seven sets (Mizuno, 2017) of 30 s dynamic stretching. It has been suggested that an increase in temperature may decrease the viscosity of the muscles (Bishop, 2003a) and as a consequence reduce passive resistive torque and muscle-tendon unit stiffness.

Summary

Plantarflexors provide propulsive force during locomotion and are involved in many daily and recreational/athletic activities, so it is essential to determine how they respond to acute stretching which is routinely used as part of a warm-up and training programme. Previous investigations have explored a variety of methods for optimising training protocols, from increasing strength to improving endurance to affect performance. As such, determining the effects of dynamic stretching as a commonly pre-performance enhancement strategy to prepare the plantarflexors for subsequent muscular activity is important. The body of literature reviewed here suggests that acute bouts of dynamic stretching may enhance or have no effect on

muscular performance represented by maximal voluntary strength, muscle power, sprint time and jump height. However, these effects of dynamic stretching have not been investigated in relation to different modes of strength (concentric, eccentric and isometric) and also on proprioception which may help us understand whether dynamic stretching can be detrimental to function and predispose one to injury. Therefore, the primary aims of the present research are to determine the effect of acute dynamic stretching on isotonic and isometric strength, fatigue and proprioception by a series of force-matching and position-matching tasks (Study 1). As one of the primary focus of pre-performance stretching is to increase flexibility, a further aim is to determine the effects of dynamic stretching on muscle and tendon strain (Study 1) and muscle stiffness measured using shear wave elastography as well as muscle fascicle strain and muscle thickness (Study 2) as potential contributing mechanisms to the increased end ROM. Evident from the work reviewed here, there is limited information, on the effects of acute effects of dynamic stretching on endurance running performance during maximum incremental exercise test and its effect on dynamic joint and vertical stiffness and how manipulating this stiffness can affect running economy (Study 3). Lastly, the aim was to investigate whether an increase in stretch/pain tolerance levels may be one of the potential mechanisms contributing to the increased joint ROM using fMRI (Study 4).

Chapter 3 Effect of Different Dynamic Stretching Velocities on Plantarflexor Muscles Neuromechanical and Sensorimotor Performance

Introduction

Stretching exercises are commonly incorporated into general warm-up protocols to increase the ROM at a particular joint. It is assumed that increasing joint ROM (flexibility) improves muscular performance (maximal voluntary strength, muscle power, sprint time and jump height) and prevents sports-related injuries (Shellock & Prentice, 1985). Along with this line of reasoning, physiotherapists, athletic trainers and coaches often recommend static stretching to be performed prior to exercise to help achieve optimal ROM and ideal muscle length, preparing the muscle for physical activity, and avoiding overstretching which may lead to injury. However, a considerable number of studies suggested that an acute bout of static stretching might temporarily reduce muscular performance (e.g. force and power production) prior to the events (Behm & Chaouachi, 2011; Rubini, Costa, & Gomes, 2007). Moreover, there is equivocal evidence for the effect of static stretching on reducing the risk of injury (Garrett, 1990; Gleim & McHugh, 1997; Thacker, Gilchrist, Stroup, & Kimsey, 2004; Weldon & Hill, 2003; Witvrouw, Mahieu, Danneels, & McNair, 2004).

As indicated above, pre-exercise static stretching may acutely compromise a muscle's ability to produce strength isometrically (Avela, Finni, Liikavainio, Niemelä, & Komi, 2004; Herda et al., 2008) or isotonicly (Cramer et al., 2004, 2007; Marek et al., 2005; Sekir, Arabaci, Akova, & Kadagan, 2010). Different mechanisms are proposed for this stretch-induced force and power reductions: (a) alteration in the mechanical properties of the muscle-tendon unit (Cramer et al., 2004, 2007; Kay & Blazeovich, 2008; Nelson, Allen, Cornwell, & Kokkonen, 2001; Nelson, Guillory, Cornwell, & Kokkonen, 2001; Weir, Tingley, & Elder, 2005), (b) decreases in muscle activation (Avela et al., 2004; Avela, Kyröläinen, & Komi, 1999; Behm, Button, & Butt, 2001; Cramer et al., 2007; Fowles, Sale, & MacDougall, 2000; Rosenbaum & Hennig, 1995) or (c) combination of both mechanical and neural factors (Cramer et

al., 2007). On the contrary, it has been shown that there is no stretch-induced strength loss after dynamic stretching (Aguilar et al., 2012; Herda et al., 2008; Hough, Ross, & Howatson, 2009; Papadopoulos, Siatras, & Kellis, 2005), and that dynamic stretching may improve isometric and isotonic contractions (Aguilar et al., 2012; Boyle, 2004; Manoel, Harris-Love, Danoff, & Miller, 2008; Yamaguchi & Ishii, 2005; Yamaguchi, Ishii, Yamanaka, & Yasuda, 2007). Recent evidence also indicates that dynamic stretching could facilitate power production (Manoel et al., 2008; Yamaguchi & Ishii, 2005) and improve sprint time (Fletcher & Anness, 2007; Little & Williams, 2006) and jump height (Holt & Lambourne, 2008; Hough et al., 2009; Jagers, Swank, Frost, & Lee, 2008; Pearce, Kidgell, Zois, & Carlson, 2009).

The exact mechanisms underlying performance changes associated with dynamic stretching have not been explored in a systematic way. Previous studies have suggested that a dynamic stretching regime might exert positive effects on muscular performance by elevating muscular and core temperature (Bishop, 2003a; Brown, Hughes, & Tong, 2008; Fletcher & Jones, 2004) or by increasing neuromuscular activity (Faigenbaum, Bellucci, Bernieri, Bakker, & Hoorens, 2005), that could be possibly linked to PAP (Sale, 2002; Yamaguchi & Ishii, 2005; Yamaguchi et al., 2007), where the prior acute voluntary contraction of the muscle will increase muscular force, power and contraction speed in the subsequent performance (Sale, 2002). Moreover, despite the results of several studies showing improved muscular performances following dynamic stretching (Yamaguchi & Ishii, 2005; Yamaguchi et al., 2007), no study has investigated the most efficient protocol of dynamic stretching. More specifically, the appropriate pre-participation dynamic stretching protocol (e.g. number and rate of repetitions intensity of muscle stretching, contracting the muscle group “agonist” and/or “antagonist” to the target muscle group) for affecting maximal isometric, concentric and/or eccentric strength of plantarflexors to elucidate the optimal performance for sporting activities has not been determined. Fletcher (2010) demonstrated that a fast-dynamic stretching protocol (100 beats/minute) was more efficient for an optimal jump height performance than a slow dynamic stretching one (50 beats/minute). However, the mechanism(s) underlying this effect was/were not explained. Importantly, according to the guidelines of the Canadian Society for Exercise Physiology (Behm et al., 2015), dynamic stretching may enhance performance moderately and hence may be

included in the stretching component of warm-ups to increase task-specific ROM and facilitate SSC soon before an activity, and/or when a full pre-activity routine is not completed.

Possible mechanisms for the increased ROM include an increase in muscle fibre temperature, decreased viscosity, and increased extensibility in animal models (Mutungi & Ranatunga, 1996) with one study reporting reductions in passive muscle-tendon unit stiffness with increased ROM after dynamic stretching in humans (Herda et al., 2013). Thus, limited data exist describing the mechanisms for ROM enhancement after dynamic stretching, and it is not known whether changes in stretch tolerance are as influential as in static stretching and PNF types of stretching. Therefore, to understand the mechanisms of dynamic stretching, it is necessary to examine the effects of dynamic stretching consisting of agonist muscle group contraction to the target muscle on neuromechanical muscle properties.

Proprioceptive acuity defined as an individual's ability to sense joint position, movement, and force as a means to discriminate body movement (Riemann & Lephart, 2002) could be affected by dynamic stretching. However, available research on the potential of dynamic stretching to compromise proprioceptive acuity is limited. It is suggested that changing the mechanical properties of the muscle-tendon unit may directly impair its force generating capacity (Avela et al., 1999; Fowles et al., 2000) and influence neural activation patterns (Fowles et al., 2000). As a consequence, changes in the force-length and force-velocity relationships following stretching could affect the sensation of effort and increase the error in the sense of force. It may also be reasonable to assume a reduction in muscle spindle activity after a bout of stretching since they are responsible for conveying information regarding muscle length and rate of change in length (Riemann & Lephart, 2002) causing alterations in sensory information on joint position sense.

Muscle strength and the ability to produce a high level of force and intact proprioception are suggested to play a crucial role in musculoskeletal injury, by compromising capabilities of the musculature to act synergistically and facilitate dynamic stabilisation of a joint system (Lattanzio & Petrella, 1998) making individuals more susceptible to musculoskeletal injuries by altering movement control (Sharma, Pai, Holtkamp, & Rymer, 1997). In this context, the secondary aim of this study was

to investigate the potential effect of dynamic stretching on performance and preventing muscle injury via examining its effect on the neuromuscular and sensorimotor mechanisms.

To this end, plantarflexors maximal voluntary muscle strength was assessed during isometric, as well as, both concentric and eccentric modes of contraction before and after two dynamic stretching protocols (slow dynamic stretching and fast dynamic stretching), as most injuries are believed to occur during the eccentric loading of muscle actions (Garrett, 1996). Sensorimotor performance has been defined as the ability to scale volitional force and joint position precisely. It may be expressed as the force matching error in the reproduction of a target force by the involved musculature to a given percentage of a maximum volitional force or the replication of a target joint position (Baltzopoulos & Gleeson, 2001). Exercises that maintain neuromuscular control and increase joint stability assist in injury prevention (Griffin, 2003). In addition to muscle length, ankle joint proprioceptive acuity, force matching error, and changes in muscle morphology (contributing to joint ROM) were assessed before and after dynamic stretching to achieve the aims of the study.

Materials and Methods

Participants

Eighteen healthy recreationally active participants (9 males and 9 females) from the university student and staff population (age: 28.3 ± 4.7 yrs.; height: 1.73 ± 0.10 m; body mass: 70.58 ± 11.38 kg) (Males: age 27.8 ± 2.6 years; height: 1.80 ± 0.07 m; body mass: 78.07 ± 7.69 kg; Females: age 28.7 ± 6.4 years; height: 1.65 ± 0.06 m; body mass: 63.10 ± 9.50 kg) with no recent history of traumatic lower limb injury or illness during the previous six months volunteered in the study after completing a pretest medical questionnaire and providing written and informed consent. All participants were unfamiliar with the testing protocol and were not involved in any flexibility-training program. Participants were instructed to refrain from vigorous physical activity for 48 hours before the testing sessions. Ethical approval was granted by the Research Ethics Committee of the Department of Life

Sciences at Brunel University London, and the study was completed in accordance with the Declaration of Helsinki.

As the fluctuation in female steroid hormones during the menstrual cycle does not have substantial influence on the mechanical properties of the human muscle and tendon *in vivo* (Kubo et al., 2009), and the examination of any potential effects of the menstrual cycle was beyond the scope of the current study, women with a regular menstrual cycle lasting between 28 and 32 days were included and tested at a non-specific period. Additionally, no significant effect of sex has been reported on stretching-induced changes in muscle-tendon unit stiffness and ROM (Cipriani, Terry, Haines, Tabibnia, & Lyssanova, 2012; Hoge et al., 2010), so both genders were included in the study.

Procedures

A randomised crossover controlled trial was conducted. The same participants took part in both experimental conditions, thus eliminating the influence of confounding factors. Participants visited the laboratory on two occasions separated by at least 48 hours to avoid any potential carry-over effects and promote neuromuscular recovery. A full familiarisation of the testing procedure was provided on both visits before data was collected. On the first visit, the participant underwent either a warm-up and the fast dynamic stretching protocol (100 beats/minute) or the warm-up and the slow dynamic stretching (50 beats/minute). A counterbalanced design with random assignment was used, and the dynamic stretching protocol not used on the first day was allocated on the second day. A single-blind method was used where the participant did not know the recorded scores, in order to minimise internal validity bias.

Outcome measures were taken at baseline and were re-measured after 2 minute rest post dynamic stretching protocols, which was defined as the minimum period between warm-up and start of a game/training session as used by previous researchers (Behm & Chaouachi, 2011; Chaouachi et al., 2010; Fletcher & Jones, 2004; Fletcher & Monte-Colombo, 2010; Little & Williams, 2006; Wong, Chaouachi, Lau, & Behm, 2011). An overview of the testing procedures is shown in Figure 3.1.

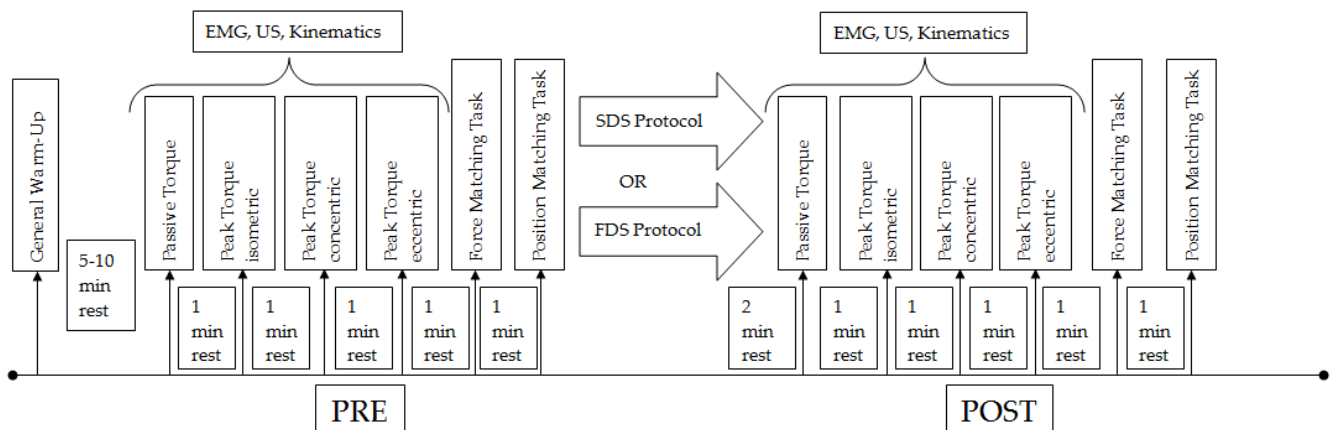

Figure 3.1. Schematic representation of the study protocol. SDS=Slow Dynamic Stretching, FDS=Fast Dynamic Stretching, EMG=Electromyography, US=Ultrasound

Warm-Up

A 5-minute standardised warm-up on a cycle ergometer (Ergonomic 874E Monark, Stockholm, Sweden) at 90W (for males) or 60W (for females) was completed by each participant. The participants then sat upright in the chair of an isokinetic dynamometer (Cybex NORM, New York, USA) with the knee fully extended (0°) to ensure that the gastrocnemius was placed under significant stretch and contributed significantly to plantarflexion moment during the test (Cresswell, Löscher, & Thorstensson, 1995; Kawakami, Ichinose, & Fukunaga, 1998). The ankle was placed in neutral position (0°) with the sole of the foot perpendicular to the shank, and the midline between the lateral and medial malleoli aligned with the centre of rotation of the dynamometer. To isolate ankle movement, stabilising straps were firmly tightened over the foot, thigh and chest, to minimise heel displacement from the dynamometer footplate during active and passive trials to provide reliable and valid ROM and passive moment during the passive trials. The participants were instructed to cross their arms over their chest, and for ankle plantarflexion to press with the ball of the foot while keeping the heel on the dynamometry foot attachment. Participant positioning is shown in Figure 3.3.

Dynamic Stretching Protocol

For performing dynamic stretching, each participant wore unrestricted clothing and was asked to stand on a step. The participants started on the balls of both feet with the heels raised and then lowering them in a controlled manner. The exercise was performed on the edge of the step to allow full dorsiflexion to be reached. The stretching exercise was performed at either 50 or 100 beats/minute controlled by a metronome (MetroTimer 3.3.2, ONYX 3 Apps, Sofia, Bulgaria) 3 sets of 20 repetitions with a 5-sec rest in between each set (Figure: 3.2a). Medial gastrocnemius was the target muscle for the stretching protocol since during the stretching active plantarflexion (concentric contraction of MG), and dorsiflexion (eccentric contraction of MG) ensured contraction of the “agonist” muscle group (ankle plantarflexors). The participants were instructed to move into full plantarflexion and dorsiflexion during the protocol.

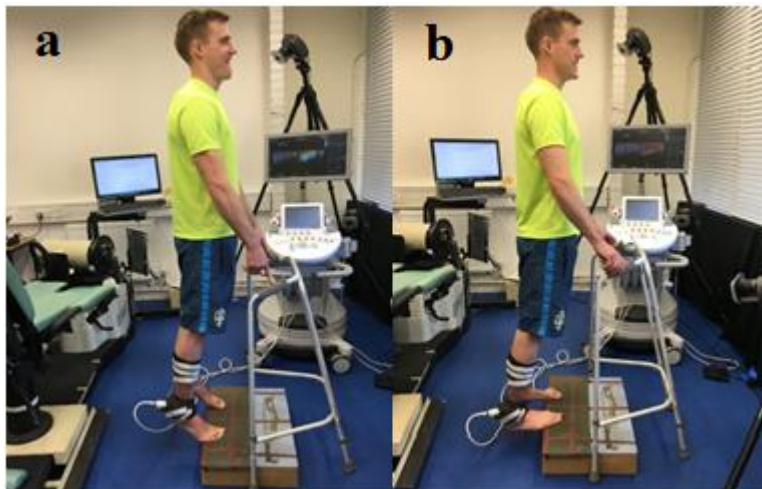

Figure 3.2 a. Start and finish position. Standing erect on the step. *b.* Position at full stretch. Participants were instructed to lower body at the desired speed and return to the starting position which was controlled by the application of an auditory cueing using a metronome.

Participant Preparation for Testing

First, 12-mm retro-reflective markers were placed on the lateral aspect of the head of the fifth metatarsal bone, first metatarsal of the foot, lateral and medial malleoli, calcaneal tuberosity, medial and lateral epicondyles of the knee joint of the dominant leg of the participants. Lower limb kinematics were captured using a seven-camera 3D motion analysis system at 120 Hz, (MAC Eagle, Motion Analysis Corporation Inc., Santa Rosa, CA., USA). The data was collected and digitised using Cortex 1.0 software (Motion Analysis Corporation Inc., Santa Rosa, CA., USA). All kinematic data were filtered using a low-pass, fourth-order, zero-lag Butterworth filter with a cut-off frequency of 6 Hz as determined by visual inspection.

The EMG and dynamometry signals (joint torque, joint angle and angular velocity) were synchronously collected with a data acquisition system, analogue-to-digital converted (CED 1401, CED Cambridge, UK) and stored on a laptop using Spike 2 v7.21 software (CED, Cambridge, UK) at a sampling rate of 2 kHz for off-line analysis.



Figure 3.3. Participant on the dynamometer for the assessment of ankle plantarflexors neuromuscular performance.

Electrode Placement

EMG was recorded using three Trigno Wireless electrode sensors (Delsys Inc., Ltd., Boston, USA), which had a predetermined bandwidth filter of 20–450 Hz with a gain of 1000, and sampled at 2000 Hz. Each interface electrode was oriented in the direction of the muscle fibre, over the MG, SOL, and TA muscles. Preferred sensor sites were chosen according to Zaheer et al. (2012). The skin of the electrode site was prepared by shaving, gentle abrasion using an abrasive gel (Nuprep, D.O. Weaver, USA), and cleansing with an alcohol tissue wipe (BSN medical GmbH, Hamburg, Germany). Specially designed double-sided tape (Delsys Inc., Ltd., Boston, USA) was applied to the electrode and attached to the muscle site. The electrodes were fixed on the skin using a hypoallergenic elastic latex-free tape. The EMG signal was collected with a data acquisition system (CED 1401, CED Cambridge, UK) and stored on a laptop using Spike 2 v7.21 software (CED, Cambridge, UK) at a sampling rate of 2 kHz for off-line analysis.

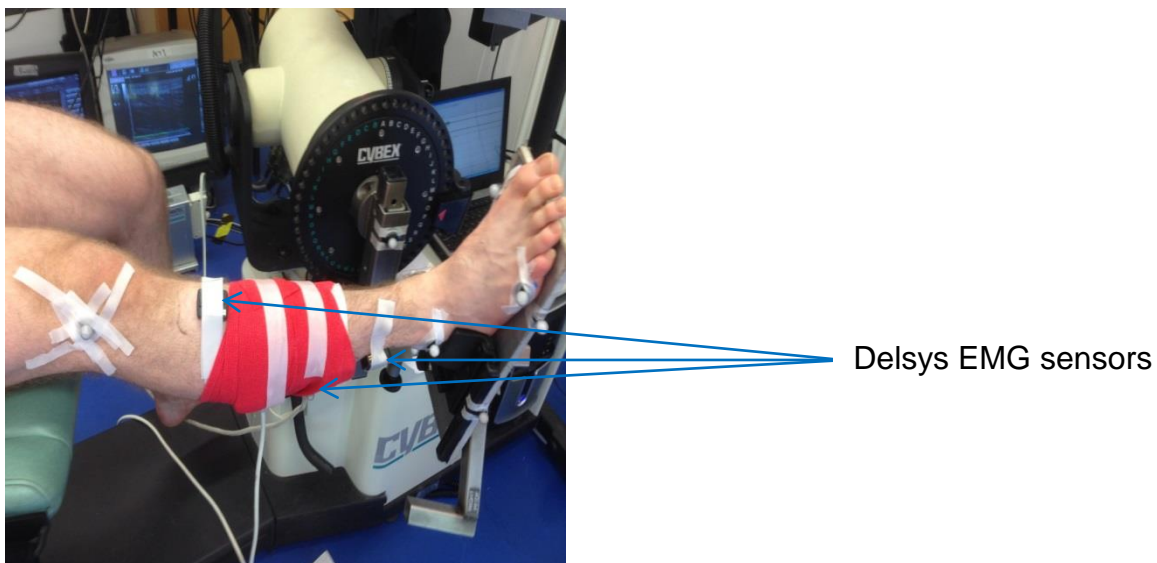

Figure 3.4. A picture of the experimental setup showing the location of the ultrasound probes, EMG sensors, and the motion analysis markers.

Assessment of Neuromechanical Performance

Passive Ankle Dorsiflexion at end ROM / Peak Passive Dorsiflexion Torque

Participants were seated in the dynamometry chair with a hip angle at $\sim 85^\circ$ and fully extended knee. The participant's foot was secured to the footplate attachment, and ankle was then manually rotated into maximum dorsiflexion end ROM through its full ROM once. A slow angular velocity ($< \sim 5^\circ/\text{s}$) was used to ensure that the stretch did not elicit any reflex mediated muscle activity which was monitored using EMG (Gajdosik, Vander Linden, & Williams, 1999). Root mean square (RMS) (measured over 2 seconds at maximum passive dorsiflexion (end ROM) was considered as being negligible if its magnitude was $\leq 10\%$ of the peak EMG amplitude during active isometric plantarflexion. Throughout the movement, the participant was encouraged to relax and not resist the passive motion of the footplate. Upon completion, the foot was released from the footplate, and the maximum passive dorsiflexion end ROM was recorded. The same tester took all flexibility measurements, to ensure reliability.

Maximum Plantarflexor Isometric Torque

The Cybex isokinetic dynamometer was used to measure maximum isometric plantarflexor torque at end ROM, before and after stretching. The participants performed a ramped isometric contraction with the ankle in the anatomical position (0°), knee in full extension (0°) and hip flexed to $\sim 85^\circ$ so that the backrest prevented the subject from moving away from the dynamometer footplate during MVIC isometric contraction. Maximal voluntary isometric contractions were thus performed with minimal calcaneal movement. Participants were instructed to keep their heel on the plate during the contraction.

Each MVIC was developed gradually over ~ 2 sec, with the maximum joint moment generated maintained for a further 1-2 sec. To aid with motivation and effort, verbal encouragement was provided for all trials and participants were able to see a real-time graph plotting the joint moment they were producing (Baltzopoulos & Kellis, 1998). The foot was released from the footplate and allowed to hang freely

with the knee flexed at $\sim 90^\circ$ after strength measurement to prevent ischaemia and stretching of the sciatic nerve which would cause limb numbness in the working limb.

Maximum Plantarflexor Isokinetic Strength

The isokinetic dynamometry strength measurement included the assessment of maximum concentric/eccentric torque of the ankle plantarflexors with a CON/ECC method. In this method, five cycles of concentric/eccentric contractions were performed at a velocity of $30^\circ/\text{s}$. The concentric and eccentric torque at neutral ankle position was collected for each of the five trials, and the maximum value was used for subsequent statistical analysis.

For the concentric/eccentric cycle, participants were encouraged to push/resist as hard as possible and to complete the full ROM. They were told to abort the test if they felt any discomfort or pain. During testing, all participants were given visual feedback from the system monitor. They were also verbally encouraged by the investigator to give their maximal effort, and the instructions were standardized by using keywords such as “push”, and “resist” and “hard and fast as possible”.

EMG Analysis

Transformation of the EMG signal from the time domain to the frequency domain was conducted with Fast Fourier Transformation. Median frequency was calculated using a script developed by CED (Cambridge, UK). A time window (epoch) (Hamming) of 1s without zero padding was used (Merletti, Farina, Frericks, & Harlaar, 1999) using 128 data points, i.e. 0.5 s either side of the maximum plantarflexor isometric torque.

Muscle Architecture

During each trial, muscle elongation was measured by tracking the alteration of the MG fascicle length from neutral to the maximum passive dorsiflexion end ROM, using B-mode ultrasonography (Echoblaster 128, UAB “Telemed”, Vilnius, Lithuania) in the sagittal plane. A layer of water-based gel (Henleys Medical Supplies Ltd., Hertfordshire, UK) was applied between the ultrasound probe and skin for enhanced acoustic transmission without depressing the dermal surface. The probe was aligned to the midline of the muscle so that it was approximately on the same plane as the muscle fascicles. The probe was fixed in position using a custom-made holder and was securely bandaged to the leg with Cohesive Bandage (CURRAGH Veterinary Supplies, Culworth, Oxfordshire). Images were collected by a personal computer (PC) and recorded in cine loop which resulted at 20 frames/second. The images were saved as a TVD file for further analysis.

Ultrasound images were digitized using routines custom-written in Matlab (MathWorks, Inc.; Natick, MA) (Lee & Piazza, 2009). The pennation angle was measured as the angle between the fascicular path and the deep aponeurosis (Abe, Fukashiro, Harada, & Kawamoto, 2001; Abe, Kumagai, & Brechue, 2000; Kumagai et al., 2000). Fascicle length (l_f) was estimated using the muscle thickness (t), the distance between the superficial and deep aponeuroses, and the pennation angle θ according to $l_f = t / \sin \theta$ (Abe et al., 2001, 2000; Kumagai et al., 2000) as shown in figure 3.5. These measurements were made at approximately the mid-belly of the muscle as changes at this site have been shown to be relatively uniform (Lichtwark, Bougoulas, & Wilson, 2007). Three optimal and identifiable fascicles were selected and identified together with the deep and superficial aponeuroses. These fascicles were tracked in each frame of the pre- and post-stretch trials and an average of the three fascicles was used for subsequent analysis (Theis, Korff, Kairon, & Mohagheghi, 2013).

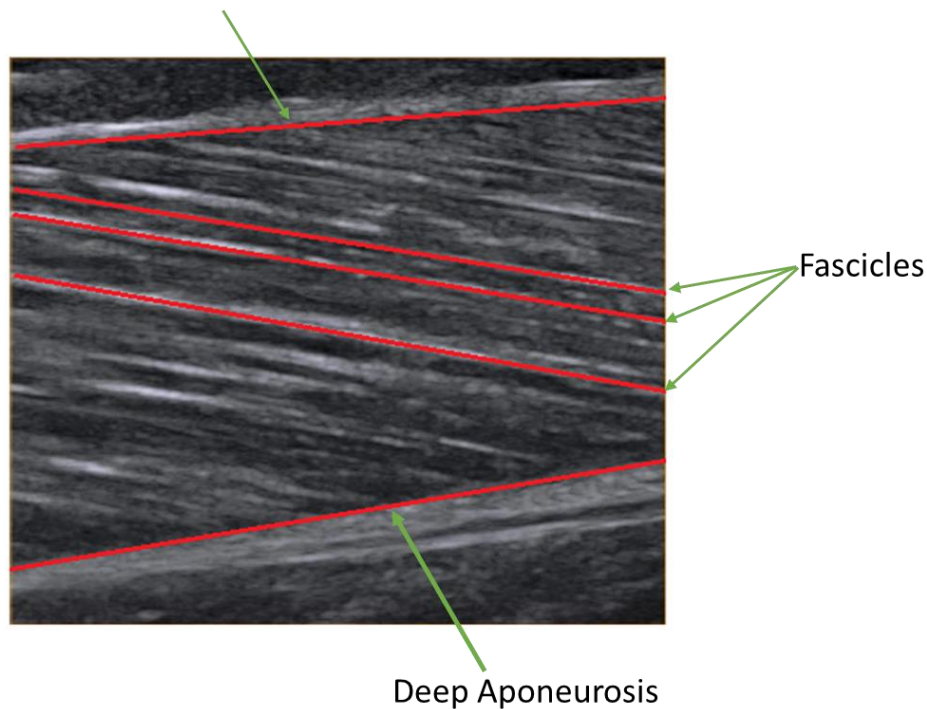

Figure 3.5. A representation of how the fascicle length, superficial and deep aponeuroses of the MG were identified using the Matlab script.

Filtered motion analysis and dynamometry data were down-sampled to 20 Hz to match the sampling frequency of the ultrasound data. The ultrasound data was then synchronised with kinematic and dynamometry data by using the cine loop synchronization output of the ultrasound system and using a Matlab script to export ultrasound frames with time stamps (Farris & Lichtwark, 2016) to match the kinematic and dynamometry data frames.

Muscle, tendon and the entire muscle-tendon unit length were calculated from a combination of motion analysis, ultrasound data, and dynamometry. The muscle-tendon unit length at each joint angle was estimated using a cadaveric regression model (Grieve, Pheasant, & Cavanagh, 1978):

$$l_g = l_{ref} + (A_0 + A_1\theta_a + A_2\theta_a^2 + K_0 + K_1\theta_k + K_2\theta_k^2) * l_s / 100$$

where l_{ref} refers to the distance between the lateral epicondyle of the femur and lateral malleolus of the fibula with the knee at full extension (0° angle) and ankle at

90°; A_0 , A_1 , A_2 , K_0 , K_1 , K_2 are coefficients found in Table 1.1; θ_a is instantaneous ankle angle, and l_s is shank length).

Table 3.1. Coefficients for gastrocnemius length (Grieve et al., 1978).

A_0	A_1	A_2	K_0	K_1	K_2
-22.18468	0.30141	-0.00061	6.46251	-0.07987	0.00011

Since the knee angle is zero throughout the testing then the formula is:

$$l_g = l_{ref} - 22.18468 + 0.30141(90 + \theta_a) + 0.00061(90 + \theta_a)^2 * l_s / 100$$

To estimate changes in the gastrocnemius muscle-tendon unit (sum of free tendon and aponeurosis lengths at distal and proximal ends) length, the fascicular length at neutral and at passive dorsiflexion end ROM was subtracted from the respective changes in the musculotendinous complex, after accounting for the pennation angles measured using Fukunaga et al. (2001) musculotendinous model (Figure 3.6):

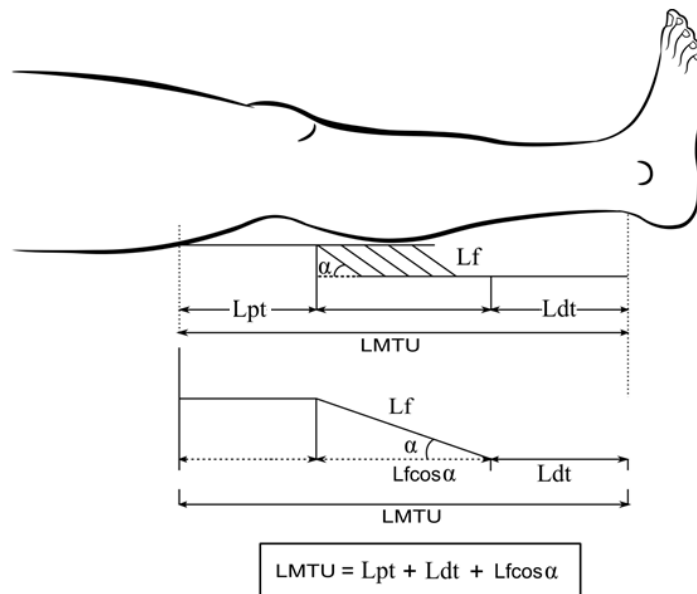

Figure 3.6. The musculotendinous model used to estimate tendon length changes. L_f is the fascicular length, α is the pennation angle, L_{pt} is the proximal tendon (free tendon and aponeurosis) length, L_{dt} is the distal tendon (free tendon and aponeurosis) length, and L_{mtu} is the musculotendon unit length. The total tendon length ($L_{pt} + L_{dt}$) equals $L_{mtu} - L_f \cos \alpha$.

Passive Muscle and Tendon Strain

Strain, designated by the Greek letter epsilon (ϵ), is defined as the percentage of the change in length to the resting length. Thus:

$$\epsilon = \frac{l - l_o}{l_o} \times 100$$

where l is the final length and l_o is the original length of the tissue.

Pennation angle

The pennation angle was determined from the mid-belly of the MG muscle. A single image was taken while the subject was on the Cybex dynamometer at neutral

ankle position as described above, while the participant was advised to relax as completely as possible. Three optimal and identifiable fascicles were selected as well as the deep and superficial aponeuroses. These fascicles were tracked in each frame of the pre- and post-stretch trials; the average angle of pennation of the three fascicles was used for subsequent analysis.

Normalised Muscle Thickness

Normalised muscle thickness was calculated as a percentage of the difference of the changes in thickness to the resting thickness.

Assessment of Sensorimotor Performance

Force Error

The participants were required to reproduce a prescribed 'target' force four times. Target force was around 50% of their maximum torque at neutral ankle angle produced during (pre- or post-stretching) measurement and was associated with the expression of maximum muscle power during dynamic muscular activations according to force–velocity and power–velocity relationships (Hill, 1938). Participants were then asked to close their eyes and produce a force at their perceived target force in a 'blinded' fashion. The aim was to match the target force as closely as possible. Participants received no verbal feedback from the test administrator to improve performance precision.

In this way, participants were blinded to both the absolute level of the prescribed target force and the magnitude of measurement. Four trials were recorded. A rest period of 10 seconds was introduced between trials (Moore & Kukulka, 1991). A target force and lower scores reflect better sensorimotor performance. For all performance trials, the force error (FE) was calculated using the following equation:

$$FE = \frac{|(\text{observed performance score}) - (\text{target performance score})|}{(\text{target performance score})} \times 100$$

The mean FE of the four trials was used for subsequent data analysis.

Positional Error

Positional Error (PE) test involved evaluating the participant's ability to reproduce specific joint angles (Lattanzio & Petrella, 1998) and has been used in clinical settings commonly. The reproduction of ankle angle was performed in a 'closed kinetic chain' manner, with the participant position as described previously. From a reference ankle angle (20° plantarflexion), the administrator passively moved the participant's ankle to the target neutral ankle angle (0°) and held this 'target' position for 3 seconds and then returned to the reference angle. Participants were then asked to reproduce the test angle passively (i.e. the assessor moved the foot platform until the participant verbally indicated positional congruence of the ankle joint with the 'target' angle) without visual-feedback in three discrete trials. The mean angular error associated with the three trials between the test angle and the participant's attempt to reproduce this angle precisely was recorded from the HUMAC NORM Testing and Rehabilitation System software (CSMi, Stoughton, MA) integrated into the dynamometer. The level of sensorimotor performance was calculated using the following equation:

$$PE = \frac{|(\text{observed performance score}) - (\text{target performance score})|}{(\text{number of trials})}$$

Statistical Analysis

Data are presented as mean \pm standard deviation (SD). Data analysis was undertaken using a post-only crossover trial with adjustment for a predictor (covariance) spreadsheet (Hopkins, 2006). Differences between trials were expressed as percentages determined from log-transformed and subsequently back-

transformed data, with 90% confidence intervals (CI) reported as estimates of uncertainty to quantify the magnitude of the difference between pre-intervention and post-intervention outcome performance measures (Hopkins, Marshall, Batterham, & Hanin, 2009). According to Hopkins et al. (2009), this is the appropriate method for quantifying changes in athletic performance. Dependent variables were analysed either as log-transformed data [torque, muscle strain, tendon strain, passive torque, force error, positional error] or raw data [ROM, pennation angle] (Hopkins, 2015). In athletic performance research, it has been argued that it is not whether an effect exists but how big the effect is that matters and the use of the P-value alone provides no information about the direction or size of the effect or the range of feasible values (Hopkins et al., 2009). The magnitude of the effect size (ES) was classified as trivial (<0.2), small (0.2-0.6), moderate (0.6-1.2) or large (2.0-4.0) and extremely large (>4.0) via standardised thresholds (Hopkins et al., 2009). The threshold value for the smallest worthwhile change was set at 0.2 between-subject standard deviation. Mechanistic inference was then based on the disposition of the 90% CI for the mean difference to this smallest worthwhile effect; the probability (percent chances) that the true population difference between trials is substantial (beneficial/detrimental) or trivial was calculated as per the magnitude-based inference approach (Batterham & Hopkins, 2006). Where the 90% CI overlapped the thresholds for the smallest worthwhile change in both positive and negative sense, the true effect was classified as unclear. In the event that a clear interpretation was possible these percent chances were qualified via probabilistic terms assigned using the following scale: <0.5%, most unlikely or almost certainly not; 0.5–5%, very unlikely; 5–25%, unlikely or probably not; 25–75%, possibly; 75–95%, likely or probably; 95–99.5%, very likely; and >99.5%, most likely or almost certainly (Hopkins et al., 2009).

Results

Performance Outcomes

Table 3.2. shows the descriptive statistics and mean differences in the slow dynamic stretching and fast dynamic stretchings measures along with effect size and qualitative inferences.

Table 3.2. Descriptive statistics and mean differences in the slow dynamic stretching (SDS) performance measures along with effect size, qualitative inferences.

Performance measures	Pre-stretch (mean± SD)	Post-stretch (mean± SD)	Mean difference (±90% C.I.)	Effect size (±90% C.I.)	Likelihood (%) of SDS being increased/trivial/decreased	Qualitative Inference
Maximum Passive Ankle Dorsiflexion ROM (°)	19.3 ± 6.3	21.0 ± 7.9	+1.8 ±1.2	+0.27 ± 0.18	75/25/0	Likely increase
Passive Dorsiflexion Torque at end ROM (Nm)	20.3 ± 6.6	23.4 ± 9.0	+13.9 ±8.2	+0.35 ± 0.19	90/10/0	Likely increase
Maximum Isometric Plantarflexion Torque (Nm)	91.1 ± 26.6	95.3 ± 26.0	+5.2 ±3.5	+0.15 ± 0.10	19/81/0	Likely trivial
Maximum Concentric Plantarflexion Torque (Nm)	77.6 ± 27.4	84.7 ± 22.9	+14.1 ±11.8	+0.26 ± 0.28	70/30/0	Possibly increase
Maximum Eccentric Plantarflexion	83.9 ± 28.2	90.8 ± 22.0	+11.4 ±9.0	+0.24 ± 0.18	65/35/0	Possibly increase

Performance measures	Pre-stretch (mean± SD)	Post-stretch (mean± SD)	Mean difference (±90% C.I.)	Effect size (±90% C.I.)	Likelihood (%) of SDS being increased/trivial/decreased	Qualitative Inference
Torque (Nm)						
Muscle Strain (%)	20.10 ± 13.78	13.03 ± 9.67	-38.0 ±19.7	-0.66 ± 0.43	0/4/96	Very likely decrease
Tendon Strain (%)	1.00 ± 2.06	2.33 ±1.41	+49.5 ±35.2	+0.77 ± 0.45	98/2/0	Very likely increase
Muscle-tendon unit Strain (%)	3.23 ±1.00	3.50 ±1.23	+5.8 ±6.9	+0.16 ± 0.18	34/65/0	Possibly increase
Resting Pennation angle (°) at neutral	15.70 ±2.84	16.00 ±3.09	+0.3 ±0.6	+0.10 ±0.20	20/79/1	Likely trivial
Normalised Muscle Thickness (%)	11.85 ± 12.20	7.84 ± 10.16	-3.3 ±3.5	-0.26 ± 0.27	0/35/65	Possibly decrease
MG EMG (Median Frequency) during MVIC	116.37 ± 31.75	112.60 ±35.49	-4.3 ±8.4	-0.14 ±0.28	3/62/35	Possibly decrease
SOL EMG (Median Frequency) during MVIC	93.26 ± 33.44	104.4 ± 31.26	+15.4 ±10.4	+0.32 ± 0.20	85/15/0	Likely increase
Force Error (%)	20.63 ± 12.30	20.82 ±12.28	-3.6 ±36.5	-0.05 ± 0.53	21/47/32	Unclear get more data
Positional Error (°)	3.2 ± 2.6	2.5 ± 3.2	-24.1 ±35.0	-0.24 ± 0.39	3/40/57	Possibly decrease

Note. Torque, EMG values, muscle strain, tendon strain, passive torque, force error and positional error are reported as log-transformed data. ROM and pennation angle are reported as raw data.

Table 3.3. Descriptive statistics and mean differences in the fast dynamic stretching (FDS) performance measures along with ES, qualitative inferences

Performance measures	Pre-stretch (mean± SD)	Post-stretch (mean± SD)	Mean difference (±90% C.I.)	Effect size (±90% C.I.)	Likelihood (%) of FDS being increased/trivial/decreased	Qualitative Inference
Maximum Passive Ankle Dorsiflexion ROM (°)	19.00 ± 6.2	21.1 ± 6.3	+2.1 ±0.8	+0.32 ± 0.19	86/14/0	Likely increase
Passive Dorsiflexion Torque at end ROM (Nm)	21.00 ± 5.5	23.5 ± 7.6	+10.5 ±8.5	+0.35 ± 0.27	83/17/0	Likely increase
Maximum Isometric Plantarflexion Torque (Nm)	93.9 ± 26.1	96.9 ± 28.3	+3.8 ±3.6	0.10 ± 0.10	5/95/0	Likely trivial
Maximum Concentric Plantarflexion Torque (Nm)	84.7 ± 23.0	90.7 ± 28.6	+8.0 ±6.4	+0.18 ± 0.14	40/60/0	Possibly increase
Maximum Eccentric Plantarflexion Torque (Nm)	90.8 ± 27.0	95.8 ± 20.7	+5.3 ±4.1	+0.12 ± 0.09	8/92/0	Unlikely positive
Muscle Strain (%)	24.67 ± 12.92	21.17 ± 13.02	-13.2 ±20.4	-0.23 ± 0.36	3/42/55	Possibly decrease

Performance measures	Pre-stretch (mean± SD)	Post-stretch (mean± SD)	Mean difference (±90% C.I.)	Effect size (±90% C.I.)	Likelihood (%) of FDS being increased/trivial/decreased	Qualitative Inference
Tendon Strain (%)	-0.81 ± 1.17	0.94 ± 1.53	+41.4 ±44.9	+ 0.73 ± 0.66	92/6/2	Likely increase
Muscle-tendon unit Strain (%)	3.20 ±1.02	3.48 ± 0.99	+10.2 ±7.4	+0.28 ± 0.19	76/24/0	Likely increase
Resting Pennation angle (°) at neutral	15.37 ±3.13	15.25 ± 3.13	-0.6 ±1.0	-0.17 ± 0.30	2/53/44	Possibly increase
Normalised Muscle Thickness (%)	8.83 ±7.42	9.58 ± 8.73	+0.7 ±3.6	+0.01 ± 0.47	35/51/14	Unclear get more data
MG EMG (Median Frequency) during MVIC	110.48 ±19.64	110.14 ± 25.13	-1.4 ±5.1	-0.08 ± 0.27	5/73/22	Unlikely decrease
SOL EMG (Median Frequency) during MVIC	94.64 ± 29.56	98.71 ± 36.16	-2.6 ±21.9	-0.08 ± 0.73	25/35/39	Unclear get more data
Force Error (%)	16.06 ± 11.61	20.18 ± 13.78	+31.4 ±82.9	+0.19 ± 0.42	49/45/6	Unclear get more data
Positional Error (°)	2.4 ± 2.9	+2.8 ± 2.8	+20.8 ±58.1	+0.16 ± 0.38	42/52/6	Unclear get more data

Note. Torque, EMG values, muscle strain, tendon strain, passive torque, force error and positional error are reported as log-transformed data. ROM and pennation angle are reported as raw data.

Neuromechanical Performance

Maximum Passive Ankle Dorsiflexion ROM

Tables 3.2 and 3.3 show before and after stretching values with mean differences, ES and qualitative non-clinical inferences based on post-only crossover trial analysis after dynamic stretching. Increase in passive ankle flexibility from pre to post intervention for slow dynamic stretching and fast dynamic stretching was small (ES = +0.27 and ES = +0.32 respectively). The main findings were that the effect of dynamic stretching on passive ankle flexibility was *possibly* beneficial for the slow dynamic stretching ($+1.8^\circ \pm 1.2$; mean difference \pm 90% CI) and *likely* beneficial for the fast dynamic stretching ($+2.1^\circ \pm 0.8$), respectively. Figure 3.7 below illustrates the effect of stretching.

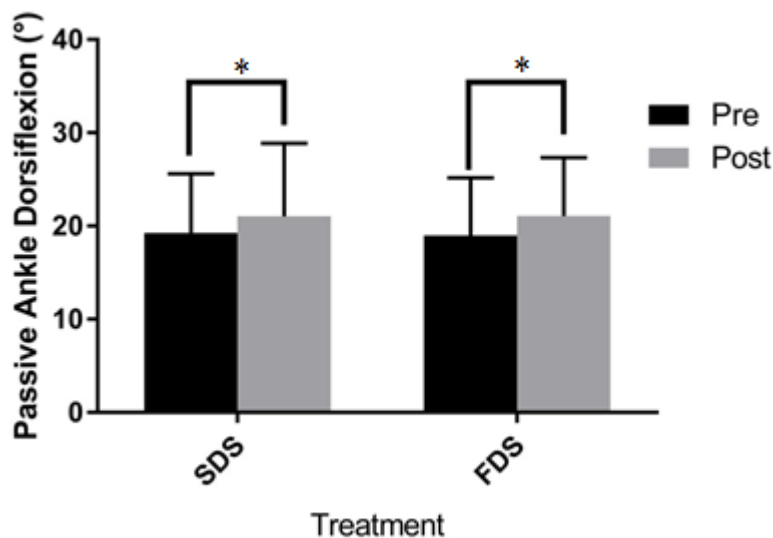

Figure 3.7. Maximum passive dorsiflexion before (pre) and after (post) slow dynamic stretching (SDS) and fast dynamic stretching (FDS); values \pm SD. + = possibly, * = likely; # = very likely; ^ = most likely.

Passive Ankle Dorsiflexion Torque at end ROM

Both slow and fast dynamic stretching protocols were *likely* beneficial for increasing passive dorsiflexion torque at end ROM: Percentage change in the passive dorsiflexion torque at end ROM was (+13.9% \pm 8.2; small effect) after the slow dynamic stretching protocol (Table 3.1), and (+10.5% \pm 8.5; small effect) after the fast dynamic stretching protocol (Table 3.2).

Maximum Plantarflexor Isometric Torque

The maximum isometric plantarflexor torque increment was *likely* trivial from pre- to post in both the slow dynamic stretching protocol (+5.2%; \pm 3.5; trivial effect) and the fast dynamic stretching protocols (+3.8 \pm 3.6; trivial effect).

Maximum Concentric / Eccentric Plantarflexor Torque

Possibly beneficial effect on increasing maximum concentric plantarflexor torque at neutral ankle position was found from pre- to post-conditioning for both slow dynamic stretching (+14.1% \pm 11.8; small effect) and fast dynamic stretching (+8.0% \pm 6.4; small effect) protocols. However, whilst the effect of slow dynamic stretching on increasing the maximum eccentric torque (+11.4% \pm 9.0; small effect) was *possibly* beneficial, fast dynamic stretching was *unlikely* to positively affect maximum eccentric torque (+5.3% \pm 4.1; trivial effect) from pre- to post-condition. Figure 3.8 below illustrates the effect of stretching on peak concentric plantarflexor torque.

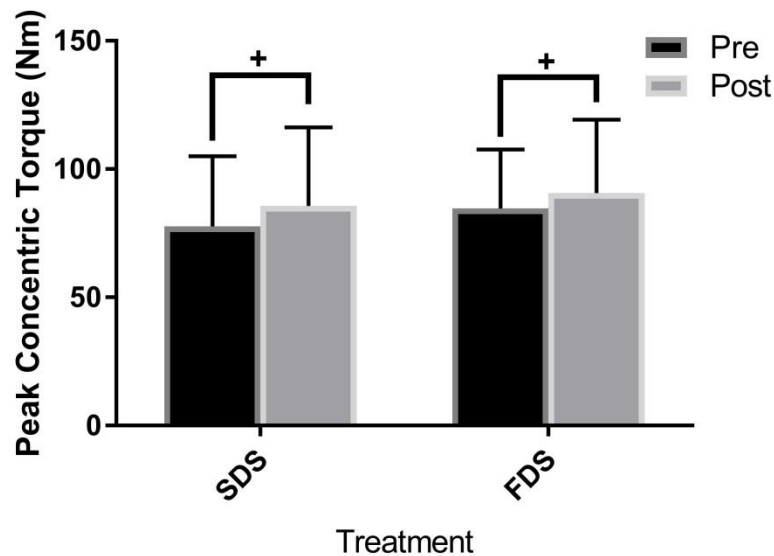

Figure 3.8. Maximum Concentric Torque before (pre) and after (post) slow dynamic stretching (SDS) and fast dynamic stretching (FDS); values \pm SD. + = possibly, * = likely; # = very likely; ^ = most likely.

Muscle and Tendon Strain

The increases in ROM were accompanied by a moderate increase in passive tendon strain for slow dynamic stretching (ES = 0.77) and fast dynamic stretching (ES = 0.73). Both slow dynamic stretching (+49.5% \pm 35.2; moderate effect), and fast dynamic stretching (+41.4% \pm 44.9; moderate effect) showed a *likely* increase in passive tendon strain. As illustrated in Figure 3.10, the effect of fast dynamic stretching on tendon strain was *likely* beneficial (-13.6% \pm 21.2; small effect). Slow dynamic stretching showed a *very likely* decrease (-38.0% \pm 19.7; moderate effect) and fast dynamic stretching showed a *possible* decrease (-13.6% \pm 20.4; small effect) on passive muscle strain. Both slow dynamic stretching and fast dynamic stretching intervention showed a *possible* increase in passive muscle-tendon strain strain (+5.8 \pm 6.9; trivial effect) (+0.28; \pm 0.19; small effect) respectively. Figures 3.9 and 3.10 below illustrate the effect of stretching on muscle and tendon strain.

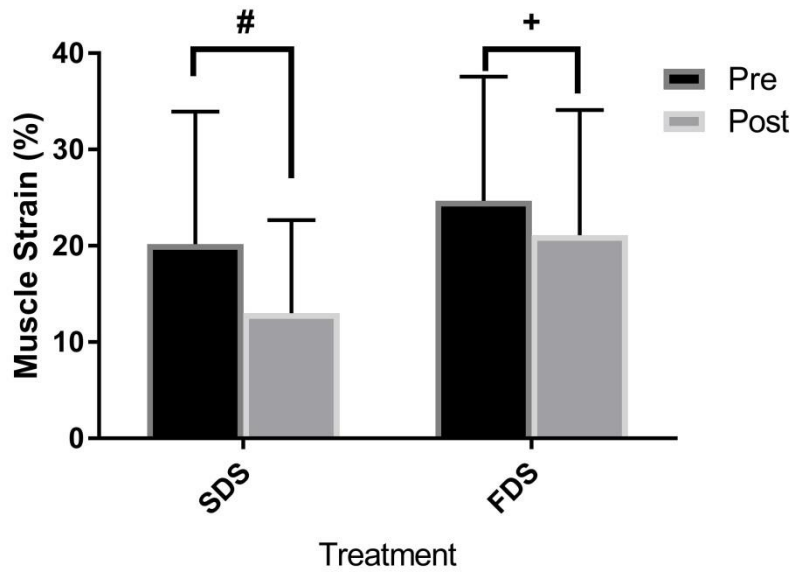

Figure 3.9. Muscle Strain before (pre) and after (post) slow dynamic stretching (SDS) and fast dynamic stretching (FDS); values \pm SD. + = possibly, * = likely; # = very likely; ^ = most likely.

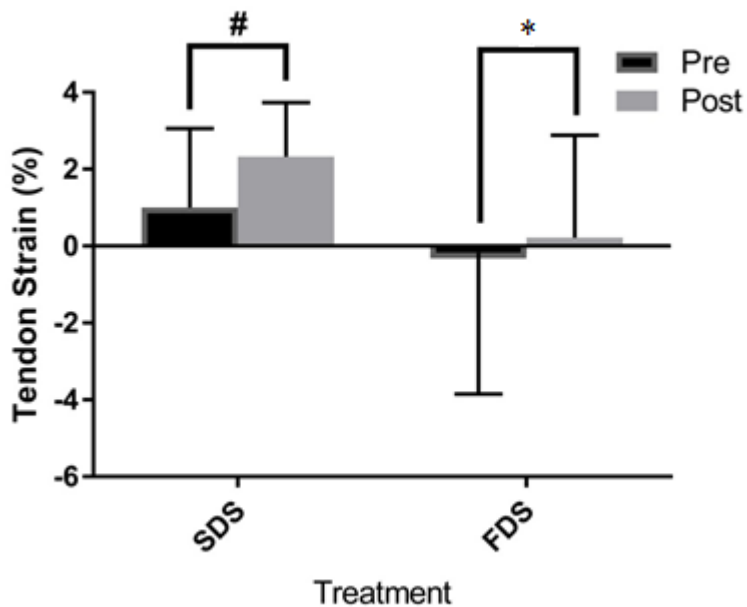

Figure 3.10. Tendon Strain before (pre) and after (post) slow dynamic stretching (SDS) and fast dynamic stretching (FDS); values \pm SD. + = possibly, * = likely; # = very likely; ^ = most likely.

Resting Pennation Angle

Likely trivial effect on pennation angle at the neutral position was found after the slow dynamic stretching protocol ($+0.3^\circ \pm 0.6$) with a trivial effect and a *possible* decrease after the fast dynamic stretching protocols ($-0.6^\circ \pm 1.0$).

Normalised Muscle Thickness

Possibly detrimental effect on the percentage change in normalised muscle thickness following the slow dynamic stretching protocol ($-3.3\% \pm 3.5$; small effect) while fast dynamic stretching on the percentage increase in normalised muscle thickness was unclear ($+0.7\% \pm 3.6$; small effect).

Electromyography

Muscle activity (median frequency of MG) *possibly* decreased after the slow dynamic stretching protocol ($-4.3\% \pm 8.4$; trivial effect) but a likely greater increase in SOL activity ($+15.4\% \pm 10.4$; small effect). An *unlikely* decrease in muscle activity of the MG following fast dynamic stretching was observed ($-1.4\% \pm 5.1$; small effect), but the effect on SOL median frequency was unclear (-2.6 ± 21.9 ; trivial effect).

Sensorimotor Performance

Force Error

Unclear effects on force-matching task following slow dynamic stretching and fast dynamic stretching were observed, a larger sample or better measures would be needed to resolve the uncertainty.

Positional Error

Slow dynamic stretching protocols showed *possibly* positive effects on the absolute error of the angle matching task: (-24.1% \pm 35.0; small effect) and unclear effect for fast dynamic stretching. Intervention leg lost the ability to replicate ankle angles passively throughout the slow dynamic stretching condition.

Discussion

The aim of the present investigation was to examine mechanisms underlying potential effects of dynamic stretching on neuromuscular and sensorimotor performance at the ankle joint. Specifically, the present study aimed to determine whether the predicted increase in passive ROM of the ankle joint in response to stretching would be accompanied by changes in the mechanical properties of the muscle-tendon unit such as gastrocnemius muscle and tendon strain. From an applied point of view, muscle strength and the ability to produce an appropriate level of force, flexibility, and intact proprioception play a crucial role in muscle strain injuries, and hence the results of the investigation could be used to determine potential effect of dynamic stretching on injury prevention.

To identify mechanisms underlying the effects of dynamic stretching on neuromechanical and sensorimotor capabilities, both neural and mechanical mechanisms associated with ankle joint movement were examined. Plantarflexors muscle strength was assessed during isometric, concentric and eccentric modes of contraction although most injuries are believed to occur during the eccentric loading of muscle actions (Garrett, 1996). Moreover, positional error, force error, and changes in muscle morphology (contributing to joint ROM) and mechanical properties of the MG muscle and tendon before and after dynamic stretching were examined.

Neuromechanical Performance

Passive Ankle Dorsiflexion ROM and Muscle and Tendon Properties

The primary finding of the study was that slow dynamic stretching and fast dynamic stretching increased passive ankle flexibility (*possibly* beneficial vs *likely* beneficial for the slow and fast dynamic stretching, respectively). This finding supports the literature that an acute bout of dynamic stretching causes an increase in ROM (Amiri-Khorasani & Sotoodeh, 2013; Bandy et al., 1998; Herda et al., 2013; O'Sullivan et al., 2009; Samukawa et al., 2011).

Findings reported here suggest that the change in passive dorsiflexion ankle ROM was due to a relatively larger increase in the strain of the tendon rather than changes to the muscle during maximum passive ankle rotation to end ROM. After both slow and fast dynamic stretching, there was a decrease in muscle strain compared to the pre-stretching situation, and increase in the overall elongation of the muscle-tendon unit was attributed to the relatively increased contribution from the tendon. This contradicted the findings of Samukawa et al. (2011) who did not find any change in the muscle fascicle length and/or pennation angle after dynamic stretching when the subject was standing, however, the ankle and knee angles were not controlled pre- and post dynamic stretching testing to make sure the postural position were identical. Acute bouts of dynamic stretching intervention at frequencies employed in the current study caused a moderate decrease for slow dynamic stretching and a small decrease for fast dynamic stretching on muscle strain which negatively affected its contribution to the increased flexibility (passive end ROM). It can be argued that increased elongation of the tendon in response to dynamic stretching contributed to the increased flexibility of the joint compared to the pre-stretching situation. This finding might have important applications during functional activities by altering length-tension properties of the muscle-tendon unit. A shift in the length-tension curve at the neutral position suggests that the fascicle operating length at mid-range muscle length might have changed. It can be speculated that there might be a shift in the optimum angle for force and torque generation at more extended joint positions limiting the potential for muscle damage (Brockett, Morgan, & Proske, 2001).

Two important and novel findings of the present study as indicated above were that an acute bout of either slow or fast dynamic stretching (1) decreased the contribution of muscle strain to the joint flexibility by 35% and 14%, respectively, and (2) increased the contribution of tendon strain to the passive joint flexibility by 1% and 2% respectively during maximum passive rotation at end ROM. A thorough search of the relevant literature yielded only one related article which examined the effect of stretch training (static stretching 3 weeks twice daily 4 x 30 s) of muscle and tendon extensibility, with Blazevich et al. (2014) reporting an increase of 13% for muscle length at end ROM without a change in tendon elongation. The present results are important because they show that different changes in acute muscle vs tendon mechanical function can be achieved through different stretch training types, which might have implications for dynamic muscle-tendon unit function and movement performance either in a sports or clinical related setting.

The decrease in muscle strain caused by the dynamic stretching protocols may indicate microtrauma to the cytoskeleton, which might possibly affect the excitation-contraction coupling process (Armstrong et al., 1993; Bruton, Lännergren, & Westerblad, 1996; Lamb, Junankar, & Stephenson, 1995; Yeung, Balnave, Ballard, Bourreau, & Allen, 2002). Armstrong et al. (1993), studying the effects of passive stretch of the rat SOL muscle, found evidence to support the idea that stretch plays a role in elevations of resting intracellular muscle Ca^{2+} and resulted in the activation of Ca^{2+} sensitive degradative enzymes which occur during eccentric exercise. However, Fredsted et al. (2008) has shown that step exercise induces muscle damage, as evidenced by increased plasma levels of muscle enzymes and increased T2 relaxation time (measure of water content of the tissue (Foley, Jayaraman, Prior, Pivarnik, & Meyer, 1999) in specific muscles which has been shown to increase after intense exercise and reflects exercise-induced damage. A study by L. Smith et al. (1993) has shown that a repeated static or ballistic stretching protocol resulted in an increase in delayed onset muscle soreness (DOMS) and serum CK levels. It can be speculated that as a result of myofibrillar disruption after the dynamic stretching intervention, structural filaments such as titin, nebulin and desmin are affected. However, this reversible muscle damage may have been not to a level to compromise the excitation-contraction coupling and subsequently affect force generation during the MVIC.

The dynamic stretching related increase in ROM is linked to the increased tendon strain. While the resting contractile elements have been shown to be more compliant than the tendon for a particular length, the much greater length of the tendon attached to the plantar flexor muscles *in vivo* means that when these muscles are stretched, much greater strains are observed in the tendon than in the contractile elements (Herbert, Moseley, Butler, & Gandevia, 2002). It may be that these larger strains induce an acute adaptation in the collagen fibres within the tendon, and this adaptation may require a repetitive/continuous changing stimulus (applied force), such as the dynamic stretching protocols employed in this study compared to the sustained steady force associated with static stretching.

Another possible mechanism that may explain the increase in tendon strain and decrease in muscle strain during passive ROM after dynamic stretching is increased tonic muscle activity. Static stretching involves a slow, controlled lengthening of a relaxed muscle. By contrast, active (static) stretching (a slower-speed version of classic dynamic stretching) causes facilitation of the stretch reflex, which is mediated by muscle spindles type Ia and II receptors affecting homonymous motor neurons excitability (Cuissard, Duchateau, & Hainaut, 1988). This activation of the stretch reflex causes a contraction in the muscle being stretched and increase in tonic muscle activity. As a result, the static stretch will have a greater influence on the relaxed (and thus more compliant) muscle tissue, whereas the active (static) stretching or dynamic stretching deals with a slightly contracted (and thus stiffer) muscle, and as a result, the relative contribution of tendon strain to the overall elongation of the muscle-tendon unit increases. However, further research is needed to identify the exact working neurological mechanism of dynamic stretching.

Theoretically, an eccentric exercise programme can lead to decreased tendon stiffness (similar to the dynamic stretching protocols in this study). This would lead to an increased ability of the tendon to store strain energy (energy absorbing capacity) and contribute to the mechanical work done by the plantarflexors during running. Cadaveric studies have also shown that the substantial capacity to store elastic strain energy can reduce muscle fibre work and metabolic energy expenditure (Alexander, 1987; Alexander & Bennet-Clark, 1977; Ker, Bennett, Bibby, Kester, & Alexander, 1987). Additionally, sports with high-intensity SSC movements have a

higher incidence of tendon injuries because they impose high loads to tendons. In these high SSC sports, muscle-tendon unit acts as an elastic-like spring during the SSC motions. To store and release these high loads without tendon tissue damage, tendons require a great energy-absorbing capacity. If this capacity is insufficient, the demands in energy absorption and release may rapidly exceed the tendon capacity. This may lead to an increased risk of tendon overload leading to an injury, increasing the energy storage capacity of tendons may be one of the key points in the prevention and treatment of tendon injuries. Increasing the tendon strain by dynamic stretching may increase its energy storing capacity and be used in injury prevention in specific types of exercise which impose high loads on the tendon.

Maximum Strength

The results of this study showed no stretch-induced impairment in MVIC following an acute dynamic stretching protocol consisting of 3 sets of 20 reps of either 50 or 100 beats/minute, as for both slow and fast dynamic stretching the effect on MVIC was likely to be trivial and almost certainly not harmful. The absence of differences between pre- and post- dynamic stretching measurements of the MVIC in the current study is in accordance with those of Herda et al. (2008), Ayala et al. (2014) and Ayala et al. (2013) who found that dynamic stretching stretching may not have any detrimental effect on the isometric strength of the leg flexors.

Median frequency is frequently used for the assessment of muscle fatigue through surface EMG signals (Cifrek, Medved, Tonković, & Ostojić, 2009), where a decrease in the median frequency of the agonist muscles with fatigue has been reported in the literature during sustained fatiguing contraction (Arendt-Nielsen & Mills, 1988; Kallenberg, Schulte, Disselhorst-Klug, & Hermens, 2007; Lloyd, 1971; Moritani, Nagata, Muro, & Moritani, 1982). The effect of slow dynamic stretching protocol on MG median frequency during MVIC was *possibly* detrimental (reflecting a possible drop in median frequency), and the effect of fast dynamic stretching was *unlikely* detrimental (reflecting an *unlikely* drop in median frequency). Slow dynamic stretching was likely to increase the median frequency of the SOL muscles and almost certainly did not reduce it. The effect of the fast dynamic stretching on SOL

median frequency was however unclear. The decrease in EMG median frequency of the MG may be attributed to the fatigability of type II muscle fibres (around 50% of MG is composed of type II fibres). The metabolic and physiological profile of the slow twitch (Type I) fibre gives it the capacity to sustain an isometric contraction maintaining the tension that is greater than that of type II fibres (Rall, 1985). A muscle with a predominance of Type I fibres would be expected to accumulate metabolic by-products (e.g. H^+ , lactate, H_2PO_4 , adenosine diphosphate) at a lower rate than one with type II fibre types accumulation of which is strongly correlated with the decline in the median frequency of the power spectrum, and subsequently could resist fatigue (Bouissou, Estrade, Goubel, Guezennec, & Serrurier, 1989; Laurent, Portero, Goubel, & Rossi, 1993; Vestergaard-Poulsen et al., 1992). It was expected to observe a higher drop in MG median frequency during fast dynamic stretching. It is possible that faster rate of fast dynamic stretching resulted in participants not stretching the muscles fully and muscle force was not produced at higher values compared to the slow dynamic stretching situation. Therefore, the level of muscle fatigue during fast dynamic stretching could have been lower compared to the slow dynamic stretching condition.

Although the slow dynamic stretching protocol employed in the current study did result in some degree of fatigue in the early stages of recovery (i.e. 2 minutes post stretching) in the MG, the performance of subsequent contractions measured by maximum isometric torque was unchanged. At least two mechanisms can be involved in preserving muscle strength after stretching: first, it can be speculated that a potentiation of subsequent performance during the 2-minute recovery period for isometric contraction occurred (Tillin & Bishop, 2009). Second, it has been suggested that with smaller pennation angles the muscle has a mechanical advantage for force transmission to the tendon (Folland & Williams, 2007; Fukunaga, Ichinose, Ito, Kawakami, & Fukashiro, 1997). Measuring the pennation angle immediately after slow dynamic stretching at neutral angle showed no change from pre-stretching values while fast dynamic stretching resulted in a decrease in the resting pennation angle 2 minutes following the intervention. However, conditioning contractions may increase tendon compliance (Kubo et al., 2001a) and this may counter any increase in the force transmission caused by a decrease in pennation

angle especially during fast dynamic stretching since no detrimental effect was found.

Another important finding of the current study is the *possibly* beneficial and *almost certainly* not detrimental effects of slow dynamic stretching on maximum concentric torque, and *possibly* trivial and *almost certainly* not detrimental effect of fast dynamic stretching on maximum concentric torque. The effect of slow dynamic stretching was *possibly* beneficial and *almost certainly not* detrimental, and the effect of fast dynamic stretching was *possibly* trivial and *almost certainly not* detrimental on maximum eccentric torque. Perhaps the angular velocity used (i.e. 30 deg/s) was more similar to the speed employed in the slow dynamic stretching protocol and hence was possibly beneficial to the isokinetic strength measured at slow velocity. In other words, application of dynamic stretching speeds similar to the speed of contraction during movement possibly benefits torque production during dynamic movements, and it is certainly not harmful.

These findings contradict a study by Costa et al. (2014) who found a significant decrease in knee flexors concentric and eccentric strength at speeds of 60 deg/s and 180 deg/s in women (4 sets of 4 dynamic exercises of the anterior and posterior thigh muscles each lasting 30 s with 15 s rest periods between sets). Two exercises targeted the anterior muscles of the thigh, and two targeted the posterior muscles of the thigh. This different result can be attributed to the effect of methodology (e.g. additional sub-maximal isometric contractions) which was performed as part of the warm-up. Repeated isometric contraction alone can induce changes in the mechanical properties of the muscle-tendon unit (Kubo et al., 2001c; Maganaris, Baltzopoulos, & Sargeant, 2006). As such, subsequent stretching may have had a little extra effect (D. Taylor, Brooks, & Ryan, 1997). On the other hand, Sekir et al. (2010) found a significant increase in concentric and eccentric maximum torque of the hamstrings and the quadriceps at 60 deg/s and 180 deg/s which is in agreement with the findings of Manoel et al. (2008) who again found significant increase in knee extension strength for the same speeds. Boyle (2004) found similar results for the quadriceps but at a lower speed of ~30 deg./s (0.52 rad/s). Aguilar et al. (2012) found significant improvements in eccentric quadriceps strength at 60 deg/s but not statistically significant increase in concentric torque.

The discrepancy between the above studies and the results of this study might be attributed to the different stretching/experimental protocols (intensity, volume, duration of rest intervals between the consecutive sets) before the execution of the performance activity, gender (Tsolakis, Bogdanis, Nikolaou, & Zacharogiannis, 2011) and the different muscle groups utilised. Costa et al. (2014) study used dynamic stretching that involved controlled repetitions for 30 s while not counting the number of repetitions within the 30 s period, Sekir et al. (2010) stretched slowly at first (5 repetitions) and then “as quickly and powerfully as possible” (10 repetitions) which may be more synonymous with a traditional warm-up whereas in this study a metronome was used in order to control the pace of the stretching protocols at either 50 or 100 beats/minute as well as the number of repetitions. Additionally, Costa et al. (2014) testing took place approximately 5 min after stretching whereas the testing in this study was done after 2 min while the muscle was pre-conditioned. So the time elapsed between stretching and testing might have allowed small changes in torque development capacity to dissipate, whereas a longer delay might have allowed torque producing capacity to return to baseline between the end of the dynamic stretching intervention and strength assessment. Ayala et al. (2013) found no strength changes in eccentric maximum torque of the hamstrings muscles at speeds of ~ 60 deg/s and ~ 180 deg/s stretched at a speed of one stretch cycle every 2 s (0.5 Hz) after stretching. However, the stretching of this study was one-quarter of the duration of the dynamic stretching protocol used by Costa et al. (2014) – 16.1 ± 2.6 min as well as a slower stretching speed which might be one of the reasons the protocol did not affect muscle eccentric strength. Additionally, the participants in the Ayala et al. (2013) study were homogenous based on age and physical status, which could limit the external validity of the results.

The effects of stretching may be muscle specific. The SOL is predominately composed of slow twitch muscle fibres (89%), the gastrocnemius is of mixed muscle type (44-51%), rectus femoris (30-43%), vastus medialis (44-62%) and hamstrings (67%) of slow twitch fibres (Johnson, Polgar, Weightman, & Appleton, 1973). Animal models have revealed that fast and slow twitch fibres respond differently to stretch, with slow twitch fibres showing a stiffer short range elastic response (Mutungi & Ranatunga, 1996). *In vivo* evidence for this has also been demonstrated in humans, with the SOL demonstrating a greater short-range stiffness than the gastrocnemius

(Babic & Lenarcic, 2004). Furthermore, the viscoelastic properties of muscle have been shown to be related somewhat to the properties of the titin protein (Ranatunga, 2001; Tskhovrebova, Trinick, Sleep, & Simmons, 1997), and particularly the I-band region (Linke & Leake, 2004). Titin isoforms tend to vary in muscles of different fibre types (Horowitz, 1992), and these possess different magnitudes of I-band extensibility (Mutungi & Ranatunga, 1996). It may be that dynamic stretching acts differently on muscles with different intrinsic stiffness. As such, the possibility that the effects of dynamic stretching are dependent on fibre type cannot be discounted. Furthermore, participants with a higher percentage of fast twitch fibres would have a greater number of higher order motor units in reserve, which could be activated via decreased transmitter failure and a greater increase in higher-order motor unit recruitment. This would result in a greater PAP response.

Therefore, current results could not be generalised to all muscle groups because of the muscle specificity or adaptability to imposed demands, i.e. type of stretching. Additionally, the findings of the current study do not support claims (Shrier, 1999; Weldon & Hill, 2003) which have suggested that an acute bout of stretching as part of a warm-up procedure may increase the relative risk of injury because it induces a reduction in eccentric strength and alters absorption and release of tensile energy capacity of the muscle-tendon unit when stretched. Therefore, dynamic stretching is safe to be used as part of a warm-up.

Sensorimotor Performance

Acuity of the sensorimotor performance is considered fundamental to the successful control of movement. The findings of this study are unclear regarding the effect of either slow or fast dynamic stretching on the force matching task, and a larger number of participants are probably needed to get meaningful results. An acute bout of slow dynamic stretching had a *possibly* beneficial effect on the positional error while the effect of fast dynamic stretching on the positional error is unclear and again more data is needed to reach a conclusion.

The results are in partial disagreement with Larsen et al. (2005) and Björklund et al. (2006) who suggested that an acute bout of stretching had no effect on

positional error performance. The major finding of the present study was that the selected indices of sensorimotor performance were found to be affected following an acute bout of slow dynamic stretching: the effect of stretching was *possibly* beneficial to the absolute error associated with a passive angle-matching task. This suggests that the capability of the ankle joint system to respond precisely at vulnerable positions (neutral) was not compromised (Babic & Lenarcic, 2004).

Perhaps the development of some levels of fatigue during slow dynamic stretching, and the fact that few of the participants complained of muscle soreness on the day post exercise, may be associated with accumulation of muscle metabolite, which is suggested to activate/or sensitize mechanoreceptor (type III) and nociceptor (type IV) afferent neural fibres (Babault, Desbrosses, Fabre, Michaut, & Pousson, 2006; Gandevia, 2001; J. Taylor, Butler, & Gandevia, 2000). Group III and IV afferents are sensitised in the presence of joint inflammation/perception of pain (Coggeshall, Ah Park Hong, Langford, Schaible, & Schmidt, 1983; Grigg, Schaible, & Schmidt, 1986; Schaible & Schmidt, 1985), suggesting that they may have a proprioceptive function (Ferrell, 1980). Although they are no true mechanoreceptors, movement activates some group IV neural receptors, albeit providing a poor sense of joint position (Schaible & Grubb, 1993) which could have resulted in slight improvement in joint position sense after slow dynamic stretching reflected by a drop in absolute error in joint position.

Reduced sensorimotor performance, including the inability to match volitional force and joint position precisely, has been associated with increased risk of musculoskeletal injury, if the capabilities of the musculature to act synergistically and facilitate dynamic stabilisation of the joint system are impaired (Lattanzio, Petrella, Sproule, & Fowler, 1997). This may be attributed to the properties of some of the peripheral receptors (proprioceptors) whose firing depends on physical variables such as muscle length, the velocity of contraction, and/or rate of alteration in muscle length, force, joint, skin temperature, and pressure. For example, muscle spindle fibres provide information about body position, while Golgi tendon organs monitor degrees of tension within the skeletal unit (Lattanzio & Petrella, 1998). The physical interpretation comes from the level of activation, and the length and elasticity of the muscle, which along with exteroceptors, contributes to the capability of the synovial

joint to respond quickly to a potential damaging stimuli (Latash, 1998). This study does not entirely disapprove the notion that an acute bout of dynamic stretching alters joint position sense in healthy individuals due to the small number of participants although the slow dynamic stretching has a *possibly* beneficial effect on positional error, however, it falls short of explaining whether the observed effects were due to altered muscle spindle and other receptors output and therefore joint position sense.

Conclusion

The purpose of the present study was to determine whether an acute bout of either slow or fast dynamic stretching, likely to be used before exercise, could alter the ability of the plantarflexors to generate torque about the ankle and musculotendinous properties of the gastrocnemius. It was found that performing either slow or fast dynamic stretching increased muscle-tendon unit flexibility and was not detrimental to and sometimes augmented neuromechanical performance as measured by dynamometry. It is suggested that incorporation of a dynamic stretching protocol that closely matches the kinematics of the activity would be more likely to deliver these benefits although assessment of performance outcomes after 2 minutes of dynamic stretching may have provided more useful information for practice.

Results of sensorimotor performance (represented by the positional error and force error test) were mainly unclear. The study findings suggest that the slow dynamic stretching protocol does not compromise the sensorimotor performance of the ankle joint on the positional error test; however, a larger sample size was needed to reach sufficient conclusions. Findings from the present study show preservation of the ability and certainly not a detrimental effect on the ability to produce torque at the appropriate level, and proprioception after dynamic stretching and hence dynamic stretching (in the form employed in the present study) can be used in warmup routines.

Chapter 4 Effects of an Acute Bout of Dynamic Stretching on Biomechanical Properties of the Gastrocnemius Muscle Determined by Shear Wave Elastography

Introduction

Stretching is a fundamental component of warm-up exercises. Different types of stretching (e.g. ballistic, dynamic, static and PNF) are all effective, although not to the same extent, in acutely increasing maximum ROM (Behm & Chaouachi, 2011). From a functional point of view, however, it is more important to determine whether and in what way the mechanical properties of the muscle and tendon components of the muscle-tendon unit, which are the determinants of the muscle-tendon unit functional capacity and performance, are affected by the stretching technique. Alteration in the maximum ROM cannot identify differential modifications in the properties of the muscle and tendon, and therefore, suitability of the stretching technique to the type of exercise to be performed (Magnusson, 1998).

Similar to static stretching, increases in passive ROM following dynamic stretching correlate not only with a decrease in the passive muscle-tendon unit stiffness (Herda et al., 2013), but also with a decrease in muscle stiffness along the longitudinal axis of the muscle. The latter effect has been attributed to the decreased muscle tension after stretching (Kay & Blazevich, 2009; Morse et al., 2008; Nakamura et al., 2011, 2013; Nordez, Cornu, & McNair, 2006).

In vivo assessment of muscle properties remains a challenge that needs to be met in order to quantify individual muscle mechanical properties independent of its tendon properties and the mechanisms responsible for muscle adaptations following acute or chronic interventions (Caiozzo, 2002; Goubel & Linsel-Corbeil, 2003). To monitor such adaptation in clinical practice, practical, quantitative and sensitive techniques for assessing stretch-induced decrease in muscle stiffness are essential.

Longitudinal muscle-tendon unit and muscle stiffness have been traditionally measured either by measuring the relationship between the joint angle and passive torque developed as resistance to motion (Gajdosik, 2001; Magnusson, 1998;

McNair, Hewson, Dombroski, & Stanley, 2002; Nordez, Casari, & Cornu, 2008; Nordez, McNair, Casari, & Cornu, 2009) or by measuring the muscle-tendon junction displacement using ultrasonography from a neutral to a fully stretched position (Morse et al. 2008; Nakamura et al. 2011; Kay & Blazevich 2009; Nakamura et al. 2013). However, passive torque measurements and muscle-tendon junction displacement are influenced by several in-series and in-parallel factors such as properties of the synergistic muscles, aponeurosis, tendon, joint capsules and ligaments around a joint (Maïsetti, Hug, Bouillard, & Nordez, 2012; Riemann, DeMont, Ryu, & Lephart, 2001). Additionally, the measurement of muscle-tendon junction displacement is not possible in all muscles. The stiffness of the gastrocnemius muscle-tendon unit has also been evaluated by numerical optimisation of the measurement of passive ankle torque over ankle angle (Hoang, Gorman, Todd, Gandevia, & Herbert, 2005; Nordez et al., 2010). This method has low reliability for some parameters and cannot be used to evaluate a single muscle (Dubois et al., 2015).

A quick-release method for the evaluation of elasticity of the muscle-tendon unit was investigated by Cornu, Goubel, and Fardeau (2001), but this technique could not isolate the behaviour of one muscle either. Magnetic resonance elastography has been used to evaluate muscle stiffness as shear modulus in three dimensions (Basford et al., 2002; Bensamoun et al., 2007; Ringleb et al., 2007). However, the measurement can only be performed with the participant lying down, and the acquisition cost remains a limitation.

The problems faced with measuring single muscle stiffness can be partially resolved using shear wave elastography which is a novel ultrasound-based technique. Shear wave elastography has been used to assess the localised mechanical properties of soft tissue for about ten years. The concept of shear wave elastography imaging using acoustic radiation force was proposed by Sarvazyan et al. (1998). More recently, Bercoff et al. (2004) coupled this concept with ultrafast ultrasound imaging to provide a specific technique called supersonic shear imaging. This technique provides a quick measurement of the muscle shear modulus by analysing propagation velocity of induced shear waves in a region of interest within soft tissue in real time. On-site immediate assessment of the stiffness is possible in

a defined area in a muscle belly or tendon using a standard ultrasonic probe (Gennisson et al., 2010). Because of the assessment of the average shear wave speed within the region of interest defined on a targeted muscle, shear wave elastography allows the measurement of specific mechanical properties of the fascicles without the influence of muscle volume and from other nearby anatomical structures under specific testing conditions. When performed under well-controlled conditions, shear wave elastography has been shown to be a reliable technique for investigating muscle biomechanical properties (Akagi & Takahashi 2014; Gennisson et al. 2010; Kot et al. 2012; Lacourpaille et al. 2012; Koo et al. 2014; Dubois et al. 2015; Masetti et al. 2012) and as it does not require external manual compression applied by the operator, it has the advantage of providing also more objective outcomes (Correas et al., 2014).

Shear waves are generated in the tissue by focusing ultrasound pushing beams at different depths; then by using high-frame rate imaging (up to 20000 images/s), a movie of the shear wave propagating is recorded. B-mode images and shear wave velocity movies are acquired. The shear wave speed is retrieved from a time of flight algorithm over the acquired movie. Assuming a linear elastic behaviour (Bercoff et al., 2004), the muscle shear elastic modulus (μ) is calculated as follows (Gennisson, Catheline, Chaffaï, & Fink, 2003; Gennisson, Cornu, Catheline, Fink, & Portero, 2005):

$$\mu = \rho V_s^2 \quad (1)$$

where ρ is the density of soft tissues (1,000 kg/m³) and V_s is the shear wave speed (m/s). Muscle is highly anisotropic (Gennisson et al., 2010), thus acquisitions are performed with the probe in the plane parallel to the muscle fibres and perpendicular to the skin; this position is determined when several fibres are continuously visible on the B-mode image. The preceding relationship is valid in tissues that are infinite (or large in extent), isotropic, homogenous, linear and elastic (Sarvazyan, Urban, & Greenleaf, 2013). Since muscles do not have these characteristics this “stiffness” is reported in terms of shear wave speed (m/s) which requires few assumptions about the tissue geometry and mechanical coupling of tissue regions when measured at comparable joint angle or contraction state.

Research using elastography has been conducted to assess the effect of treatment and rehabilitation interventions on myofascial structures (Akagi & Takahashi, 2014; Kubo, Kanehisa, & Fukunaga, 2002; Luomala, Pihlman, Heiskanen, & Stecco, 2014). Whilst six previous studies which investigated the immediate effect of static stretching, ranging from 2-10 minutes duration, on gastrocnemius muscle stiffness (Akagi & Takahashi, 2013; Freitas, Andrade, Larcoupaille, Mil-homens, & Nordez, 2015; Hirata, Miyamoto-Mikami, Kanehisa, & Miyamoto, 2016; Nakamura et al., 2014; Taniguchi, Shinohara, Nozaki, & Katayose, 2015) reported a decrease in muscle shear modulus/speed, Nordez et al. (2008) reported no decrease in MG muscle belly stiffness after 10 min of static stretching.

In the above previous studies, muscle stiffness was examined only in the resting or slack muscle position. Akagi et al. (2012) found out that muscle stiffness was significantly correlated with muscle size in a resting position (i.e. with no passive tension), whereas the corresponding correlation was not significant in the stretched position. Therefore, Akagi et al. (2012) concluded that muscle stiffness in a stretched position may not depend on the muscle size.

To the best of my knowledge, no previous study has examined the effects of dynamic stretching on muscle belly stiffness. The primary goal of this study was to evaluate the effects of dynamic stretching on shear wave speed as an indirect indicator of stiffness of the MG muscle belly at three ankle positions and during standing. It was speculated that shear wave speed would (1) substantially increase after dynamic stretching at resting neutral ankle position; (2) muscle fascicle strain will decrease at end ROM, and there was going to be a positive relationship between shear wave speed and muscle fascicle strain and shear wave speed and passive ankle angle (ROM).

Methods

Participants

Seventeen healthy men [age: 35.4 ± 12.1 years; height: 1.78 ± 0.06 m; body mass: 79.41 ± 14.20 kg] and six healthy women [age: 31.2 ± 11.1 years; height: 1.61

± 0.05 m; body mass: 60.50 ± 7.04 kg] volunteered to participate in this study after reading the information sheet and signing the informed written consent form. All participants were drawn from the Brunel University London student and staff population and were unfamiliar with the testing and stretching protocol. They were informed that they could withdraw from the study at any time.

Participants were included in this study if they were healthy and did not have a history of traumatic hip or knee injury in the dominant leg during the previous six months. As the fluctuation in female steroid hormones during the menstrual cycle do not have substantial influence on the mechanical properties of the human muscle and tendon *in vivo* (Kubo et al., 2009), and the examination of any potential effects of the menstrual cycle was beyond the scope of the current study, women with a regular menstrual cycle lasting between 28 and 32 days were included and tested at a non-specific period. Additionally, no significant effect of sex has been reported on stretching-induced changes in muscle-tendon unit stiffness and ROM (Cipriani, Terry, Haines, Tabibnia, & Lyssanova, 2012; Hoge et al., 2010), so both genders were included in the study. Participants were instructed to refrain from vigorous physical activity for 48 hours before the testing sessions. The study was approved by the Research Ethics Committee of the Department of Life and Health Sciences at Brunel University London.

Study Design

A crossover controlled study (single group, repeated measures experimental design) was used for this study, eliminating issues of inter-group variability such as individual differences, strength, prior stretching knowledge, and experience. Participants acted both as a control and treatment condition, thus eliminating the influence of confounding variables. The latter control was used to eliminate the extent of random biological variations (age, sex, etc.) together with intrusions from systematic effects such as learning and lessen any type II errors that could occur. Outcome measures were assessed before and after the dynamic stretching protocol.

Time and ankle positions were the independent variables with two (pre-stretching and post-stretching) and four (fully stretched position, fully shortened and

neutral position, standing) levels, respectively. Passive ROM, shear wave speed measured by shear wave elastography, and architectural parameters (fascicle length, muscle thickness) were the dependent variables.

Experimental Procedures

A 5-minute standardised warm-up on a stationary cycle ergometer (Ergomedic 818E Monark, Stockholm) with a pedalling cadence of 60 rpm (Cramer et al., 2007) was used. Participants were asked to adjust the seat to the correct height so that the knee was slightly flexed when the foot was parallel to the ground at the lowest pedal position (Powers & Howley, 2012). This was implemented to avoid muscle injury and enhance the reliability of the measure (Semenick, 1994). All measurements were performed before dynamic stretching (pre- dynamic stretching) and after approximately 2 min of dynamic stretching (post- dynamic stretching). The participants were familiarised with the procedure and instructed to relax during the measurements.

Dynamic Stretching Protocol

For performing dynamic stretching, each participant wore unrestricted clothing and was asked to stand on a step. The participants started on the balls of both feet with the heels raised, lowering the heels in a controlled manner. The exercise was performed on the edge of the step to allow full dorsiflexion to be reached. The stretching exercise was performed at 100 beats/minute controlled by a metronome (MetroTimer 3.3.2, ONYX 3 Apps, Sofia, Bulgaria). Three sets of twenty repetitions were performed with a 5-second rest in between each set. Instructions were given to the participants to move into full plantarflexion (Figure: 1a) and dorsiflexion (Figure: 1b) during the protocol.

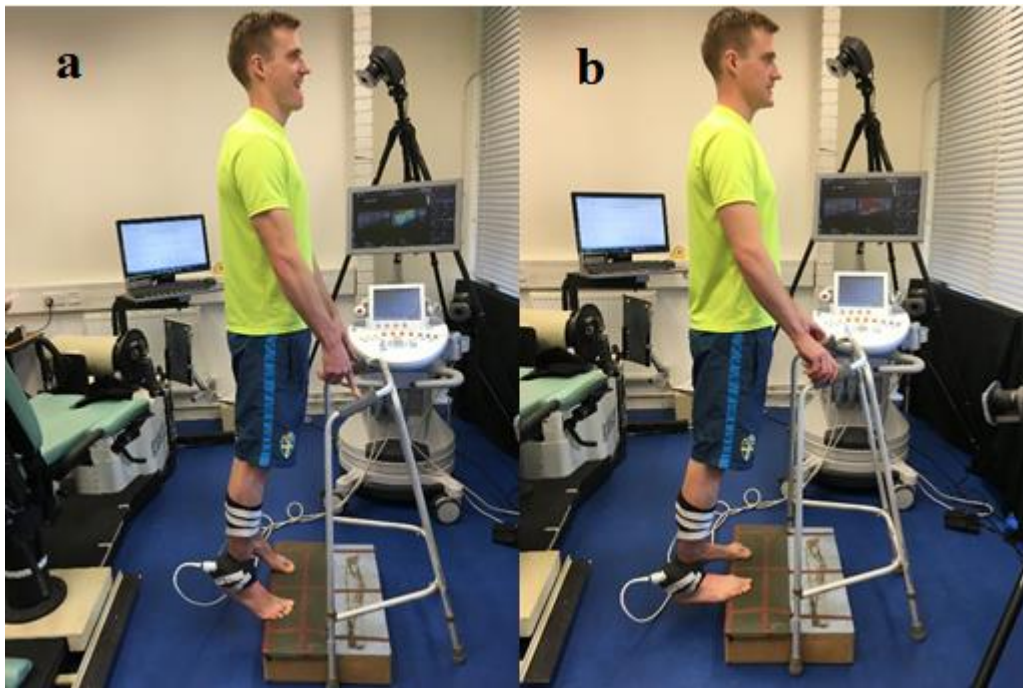

Figure 4.1 a. Dynamic stretching start position of exercises: Standing erect on a step. b. Dynamic stretching final position at full stretch: participant allows gravity to drop body at the desired speed and range (20 reps x 3 sets)

Dynamometer Testing of ROM

Participants adopted a supine position on an isokinetic dynamometer (Cybex NORM, New York, USA) with their knee in full extension and foot strapped to a foot plate to prevent the heel from lifting from the footplate. The rotational axes of the ankle joint and the dynamometer were visually aligned as closely as possible. Maximum dorsiflexion and plantarflexion passive ROM positions were determined by manually moving the footplate. A slow angular velocity was used to ensure that the stretch did not elicit any reflex mediated muscle activity ($< \sim 5^\circ/\text{s}$) (Gajdosik, Vander Linden, & Williams, 1999). Participants were instructed to advise the researcher to stop at the point of discomfort. Throughout the movement, the participants were encouraged to relax and not resist the passive motion of the footplate. Ankle angle was measured at the maximum tolerated dorsiflexion and plantarflexion positions. The perpendicular position between the foot and the leg was considered the neutral position. (i.e. 0°). Angle data was recorded from the Cybex software.

Muscle Shear Wave Speed and Fascicle Strain

An Aixplorer ultrasound scanner (version 7.0; Supersonic Imagine, Aix-en-Provence, France) and a 50-mm linear array transducer (4-15 MHz, SL15-4, Vermon, Tours France) in supersonic shear imaging mode (musculoskeletal pre-set) were used to assess MG shear elastic speed as previously described. Simultaneous B-mode images were taken to assess the muscle architecture (Bercoff et al., 2004; Tanter, Bercoff, Athanasiou, & Deffieux, 2008). The ultrasound probe was placed longitudinally on the skin surface at 30% of the lower leg length measured distal to the lateral joint line of the knee (Akagi & Takahashi, 2014; Chino & Takahashi, 2015; Kubo et al., 2015; Kumagai et al., 2000) over the gastrocnemius muscle belly. The transducer was secured with a custom-made cast and placed on the skin according to the orientation of the muscle fascicles and was securely bandaged to the leg with Cohesive Bandage (CURRAGH Veterinary Supplies, Culworth, Oxfordshire) to minimise undesired translation of the transducer. Water-soluble transmission gel (Henleys Medical Supplies Ltd., Hertfordshire, UK) was applied onto the contact surface to avoid any air gaps between the ultrasound probe and the dermal surface during the measurements.

The maps of the shear elastic speed were collected at 1 Hz within a 1 x 1 cm square and with a spatial resolution of 1 x 1 mm. A good intra-day reliability of MG shear modulus/speed has been previously reported (Brandenburg et al., 2014; Dubois et al., 2015; Lacourpaille et al., 2012; Lee, Gaebler-Spira, Zhang, Rymer, & Steele, 2016; Lee, Spear, & Rymer, 2015; Maisetti et al., 2012; Miyamoto, Hirata, Kanehisa, & Yoshitake, 2015).

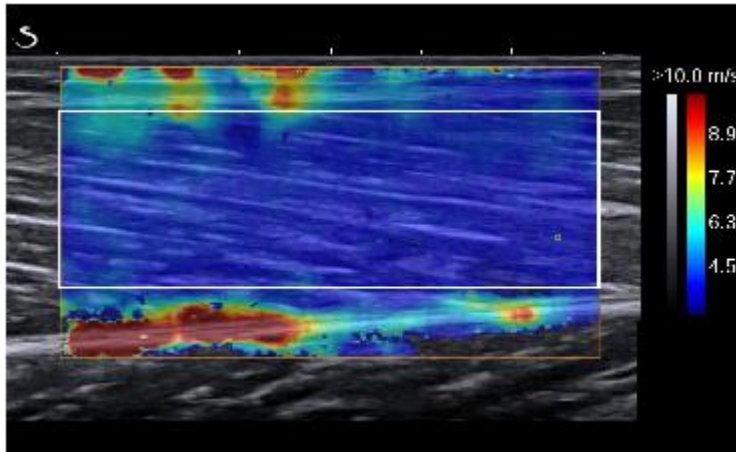

Figure 4.2. Ultrasound image of shear wave speed measurement by shear-wave elastography at the neutral ankle position.

Ultrasound Processing

For the assessment of muscle stiffness, supersonic shear imaging images were exported from the Aixplorer scanner software (Q Box) (version 7.0; Supersonic Imagine, Aix-en-Provence, France) in DICOM format. A custom-written software developed in Matlab (MathWorks, Natick, USA), was used to manually select rectangular sub-regions between the superficial and deep aponeurosis using a region of interest ROI as large as possible, avoiding the inclusion of artefacts for the muscle. The ROI of the first image was then automatically tracked on the following images and RGB value of each pixel was converted into a shear wave speed value by using the colour barcode embedded in the original DICOM image. All elastography movies were processed by the same operator. Good reliability of the supersonic shear imaging technique has been demonstrated previously (Lacourpaille et al., 2012). The shear wave speed was measured at three muscle lengths (relaxed, neutral and stretched) in prone and at a standing position. Participants were asked to relax during each recording that lasted approximately 10 seconds (i.e. ~244 frames). For each position, the 3rd up to the 8th second (i.e. a total of ~146 frames) shear elastic measurements of the ROI were computed as the mean to obtain a representative value.

For the assessment of architectural parameters, ultrasound images were digitized using a custom-written routine in Matlab (MathWorks, Inc.; Natick, MA).

Medial gastrocnemius architecture was assessed at neutral, at maximum plantarflexion and dorsiflexion end ROM positions, with the probe positioned approximately over the muscle belly. At this site changes in muscle architecture have been shown to be relatively uniform (Lichtwark, et al., 2007) in B-mode ultrasound images. The upper and lower aponeuroses were manually identified in the custom written Matlab script by setting reference points along the aponeuroses that were approximated by a linear least-square fitting. Visible features of multiple fascicles were digitized, and a representative reference fascicle was then calculated on the basis of the orientation of the digitized fascicle portions. The fascicle length was determined as the Euclidean distance between intersection points of the reference fascicle with the two aponeuroses. Muscle thickness was calculated as the distance between the two aponeuroses at the intersections points with the reference fascicle and averaged from these two values.

Passive Muscle Fascicle Strain

Strain (ϵ) of the MG muscle fascicles and tendon was defined as the percentage of the change in length to the resting length. Thus:

$$\epsilon = \frac{l - l_o}{l_o} \times 100$$

where l is the final length and l_o is the original length of the tissue. Fascicle strain was defined as the change from neutral to maximum plantarflexed or dorsiflexed position

Statistical Analysis

Descriptive statistics were reported as means and SDs. Data analysis was undertaken using a post-only crossover trial with adjustment for a predictor spreadsheet (Hopkins, 2006). Differences between trials were expressed as percentages determined from log-transformed and subsequently back-transformed data, with 90% CI reported as estimates of uncertainty to quantify the magnitude of

the difference between pre-intervention and post-intervention outcome performance measures (Hopkins, Marshall, Batterham, & Hanin, 2009). This is the appropriate method for quantifying changes in athletic performance (Hopkins et al., 2009). Dependent variables were analysed either as log-transformed data [shear wave speed at neutral, maximum plantarflexion, maximum dorsiflexion and standing positions, muscle thickness] or raw data [ROM, fascicle strain] according to Hopkins (2015) definitions. In athletic performance research, it has been argued that it is not whether an effect exists but how big the effect is that matters and the use of the P-value alone provides no information about the direction or size of the effect or the range of feasible values (Hopkins et al., 2009). The magnitude of the ES was classified as trivial (<0.2), small (0.2-0.6), moderate (0.6-1.2) or large (2.0-4.0) and extremely large (>4.0) via standardised thresholds (Hopkins et al., 2009). The threshold value for the smallest worthwhile change was set at 0.2 between-subject standard deviation. Non-clinical inference was based on the disposition of the 90% CII for the mean difference to this smallest worthwhile effect; the probability (percent chances) that the true population difference between trials is substantial (beneficial/detrimental) or trivial was calculated as per the magnitude-based inference approach (Batterham & Hopkins, 2006). Where the 90% CI overlapped the thresholds for the smallest worthwhile change in both positive and negative sense, the true effect was classified as unclear. In the event that a clear interpretation was possible, these percent chances were qualified via probabilistic terms assigned using the following scale: <0.5%, most unlikely or almost certainly not; 0.5–5%, very unlikely; 5–25%, unlikely or probably not; 25–75%, possibly; 75–95%, likely or probably; 95–99.5%, very likely; and >99.5%, most likely or almost certainly (Hopkins et al., 2009).

The magnitudes of the relationships were interpreted using Pearson's product moment correlation coefficient (r), which were converted into 90% confidence limits using a spreadsheet (Hopkins, 2007). The magnitude of r was interpreted using an adapted Cohen's scale (Hopkins, 2002): 0.00-0.10, trivial; 0.10-0.29, small; 0.30-0.49, moderate; 0.50-0.69, large; 0.7-0.89; very large, 0.90-1.00 almost perfect (Hopkins et al., 2009). An inference about the true (large sample) value of a correlation was based on uncertainty in its magnitude (Batterham & Hopkins, 2006): if the 90% confidence limits overlapped small positive and negative values, the

magnitude was deemed unclear; otherwise, the magnitude was deemed to be the observed magnitude. The CI was derived via the Fisher z transformation (Fisher, 1921). Inferences about the correlation between shear wave speed and ankle angle and shear wave speed and muscle fascicle strain were made with respect to the smallest worthwhile correlation of 0.10 (Cohen, 1977).

Reliability of Measurements

The repeatability/reproducibility of the muscle shear wave speed was determined from the values obtained from the 3rd up to the 8th second (i.e. a total of ~146 frames) shear elastic measurements for the reliability analysis. To this end, the interclass correlation coefficient (ICC), and coefficient of variation (CV) were calculated across the 3rd to the 8th second performed across the 4 ankle positions using a spreadsheet (Hopkins, 2000). To derive this within-subject variation as a CV, data was log-transformed (100 x natural algorithm) before analysis (Hopkins, 2000). To describe absolute reliability, typical error (TE) of measurement in raw units was expressed as CV (%) using Hopkins (2000) spreadsheet. Coefficients of variation of $\leq 10\%$, 10-25%, and $\geq 25\%$ were considered of good, moderate and poor reliability, respectively (Tew et al., 2011). To interpret the magnitude of a CV representing typical differences or changes in performance times, we doubled the CV before assessing it on the above scale (T. Smith & Hopkins, 2011). Absolute reliability expressed as CV for direct comparison with relevant reliability studies and TE as an indicator to aid practitioners to determine whether the observed shear wave speed changes are true physiological responses or measurements errors (Atkinson & Nevill, 1998; Hopkins, 2000). For a description of relative reliability, ICCs were determined using the same spreadsheet, with ICCs >0.75 , 0.40-0.75 and <0.40 being considered of good, moderate and poor reliability, respectively (Landis & Koch, 1977). Uncertainty in all estimates is set at 90% CI.

Results

Table 4.1. Shows descriptive statistics and mean differences in the dynamic stretching (DS) performance measures along with effect size and qualitative inferences.

Performance measure	Pre-stretching (mean± SD)	Post-stretching (mean± SD)	Mean difference (±90% C.I.)	Effect size (±90% C.I.)	Likelihood (%) of DS being beneficial/trivial/detrimental	Qualitative Inference
SWS at Neutral (m/s)	3.81 ± 0.82	4.20 ± 0.89	+11.4 ±7.3	+0.48 ±0.29	94/6/0	Likely increase
SWS at Maximum Plantarflexion (m/s)	2.34 ± 0.42	2.45 ± 0.40	+4.9 ±6.0	+0.28 ±0.33	66/33/0	Possibly increase
SWS at Maximum Dorsiflexion (m/s)	7.66 ± 1.26	6.66 ± 1.08	-12.9 ±7.5	-0.78 ±0.49	0/2/97	Very likely decrease
SWS at Standing (m/s)	4.12 ± 0.79	4.70 ± 0.16	+16.0 ±8.10	+0.74 ±0.35	99/1/0	Very likely increase
ROM at Maximum Plantarflexion (°)	45.8 ± 7.0	48.0 ± 6.4	+2.3 ±1.80	+0.31 ±0.25	78/22/0	Likely increase
ROM at Maximum Dorsiflexion (°)	17.6 ± 6.0	19.1 ± 6.11	+1.5 ± 0.5	+0.24 ±0.24	61/39/0	Possibly increase
Total ankle ROM (°)	64.9 ± 13.7	68.7 ± 12.4	3.9 ±2.2	0.27 ±0.15	78/22/0	Likely increase
Fascicle strain (%) [dorsiflexion]	16.20 ± 11.67	14.21 ± 8.08	-2.6 ±4.4	-0.21 ±0.37	3/44/52	Possibly decrease

Performance measure	Pre-stretching (mean± SD)	Post-stretching (mean± SD)	Mean difference (±90% C.I.)	Effect size (±90% C.I.)	Likelihood (%) of DS being beneficial/trivial/detrimental	Qualitative Inference
Fascicle strain (%) [plantarflexion]	-38.52 ± 13.04	-35.78 ± 10.16	+2.9 ±4.2	+0.21 ±0.31	52/46/2	Possibly increase
Thickness at Neutral (mm)	19.19 ± 3.41	19.79 ± 3.22	+4.1 ±2.0	+0.21 ±0.10	56/44/0	Possibly increase

Note. Sear wave speed (SWS) at neutral, maximum plantarflexion, maximum dorsiflexion, standing positions, and muscle thickness are reported as log-transformed data. ROM, total ROM, and fascicle strain are reported as raw data.

Passive Ankle Flexibility

Increase in passive ankle plantarflexion ROM after dynamic stretching was small (ES = +0.31). The changes (mean ± 90% CI) are shown in Table 4.1. The main finding was that the effect of dynamic stretching on passive ankle plantarflexion was *likely* greater (+2.3° ±1.8; mean difference ± 90% CI) from pre- to post.

Increase in passive ankle dorsiflexion ROM from pre- to post intervention for dynamic stretching was small (ES = +0.24). The main finding was that the effect of dynamic stretching on passive ankle flexibility was *possibly* greater (+1.5° ±1.5) from pre- to post.

Total ROM

The total ankle ROM was *likely* greater after dynamic stretching (3.9°±2.2 small effect).

Shear Wave Speed

It is *likely* that shear wave speed increased at neutral ankle joint position after dynamic stretching (+11.4% \pm 7.3; small effect). The effect of dynamic stretching on shear wave speed at maximum plantarflexion position is possibly greater (+4.9% \pm 6.0; small effect), but very likely declined (-12.9% \pm 7.5; moderate effect) at maximum dorsiflexion position from pre- to post.

Very likely greater effect on shear wave speed at standing position was found after the dynamic stretching protocol (+16.0% \pm 8.1; moderate effect).

Muscle Fascicle Strain

The muscle fascicle strain (for dorsiflexion) was *possibly* reduced after the dynamic stretching protocol (-2.6% \pm 4.4; small effect). Similarly, muscle fascicle strain (for plantarflexion) was *possibly* less after the dynamic stretching protocol (+2.9% \pm 4.2; small effect).

As demonstrated in Figures 4.3-4.6, shear wave speed was larger in the MG for larger fascicle strains and at larger dorsiflexion angles. Figures 4.1 and 4.3 show that MG shear wave speed increased as fascicle strain increased: cubic fit with a very large positive correlation $r = 0.75 \pm 0.09$; mean difference \pm 90% CI (almost certain beneficial effect) pre- dynamic stretching and very large positive correlation $r = 0.85 \pm 0.06$ (almost certain beneficial effect) post dynamic stretching. Figures 4.2 and 4.4 show that MG shear wave speed increased as ankle angle increased: quadratic fit with positive very large correlation $r = 0.87 \pm 0.05$ (almost certain beneficial effect) pre-dynamic stretching and positive very large correlation $r = 0.89 \pm 0.04$ (almost certain beneficial effect) post-dynamic stretching.

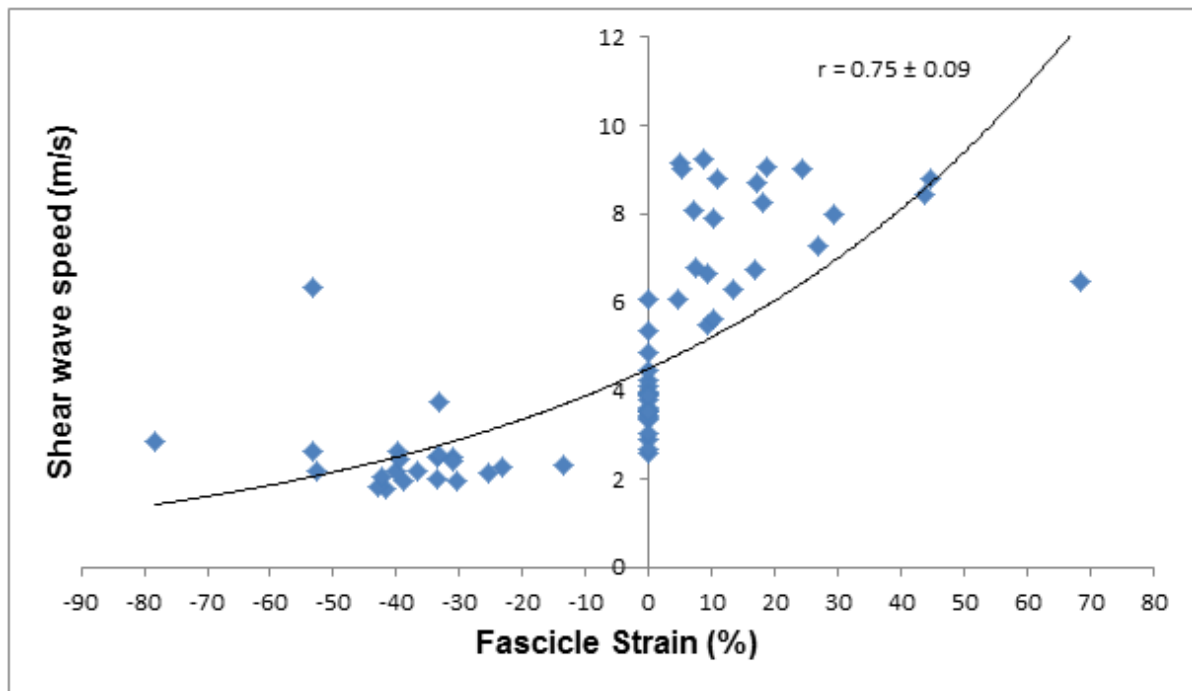

Figure 4.1. Shear wave speed of the MG plotted against fascicle strain pre-dynamic stretching.

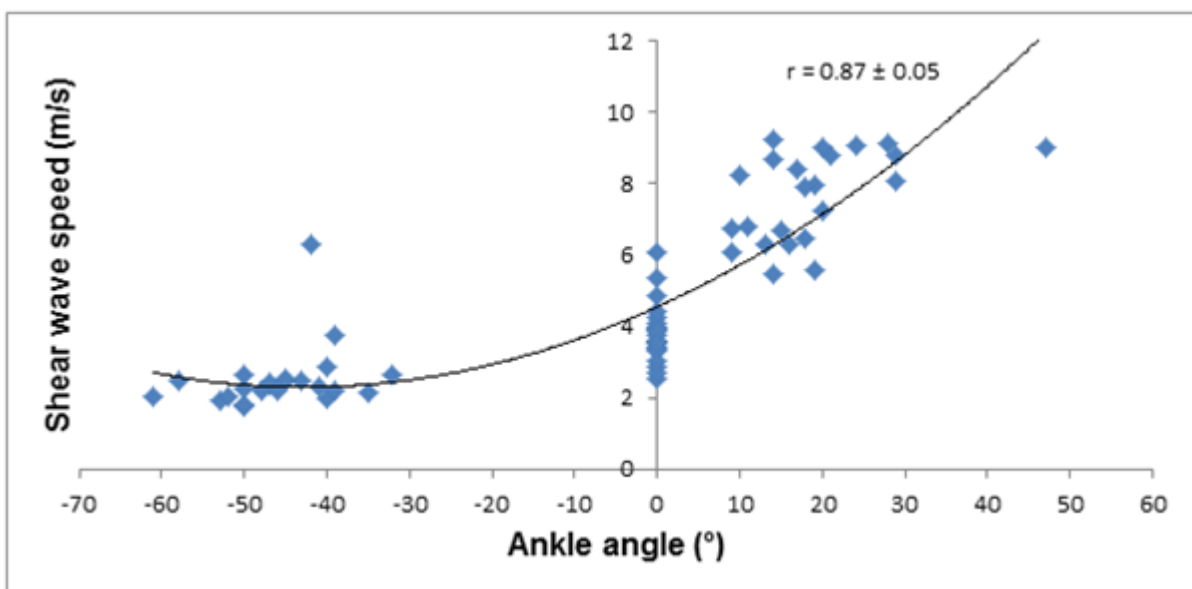

Figure 4.2. Shear wave speed of the MG plotted against ankle angle pre-dynamic stretching.

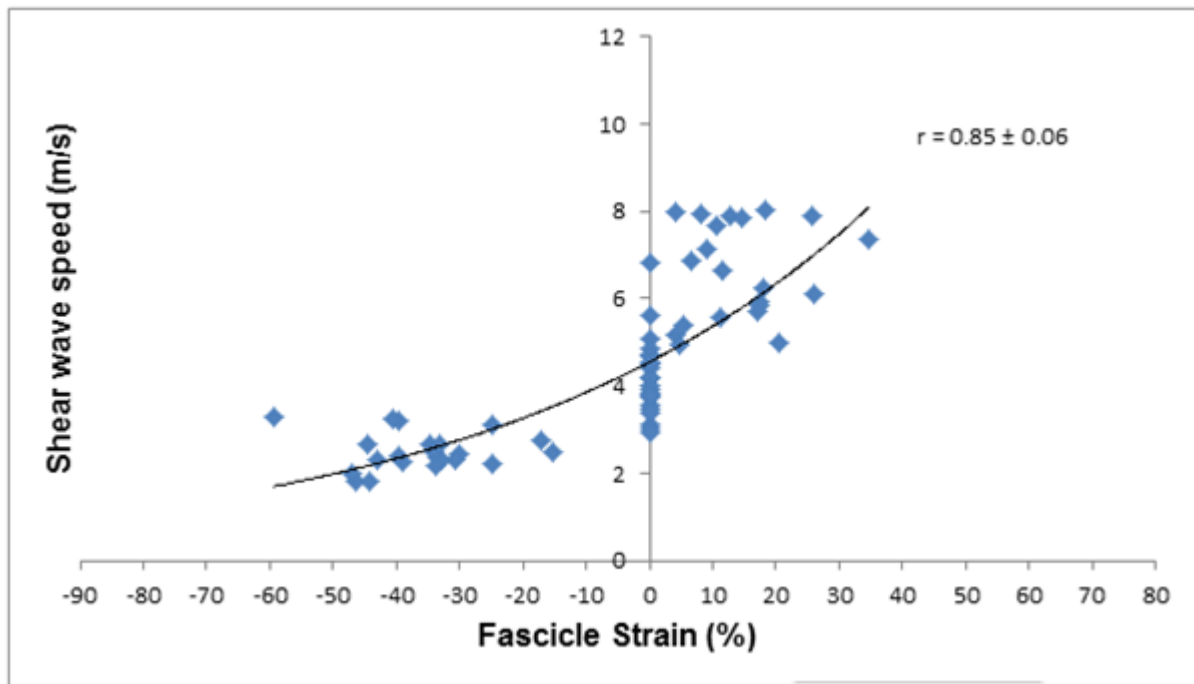

Figure 4.3. Shear wave speed of the MG plotted against fascicle strain post-dynamic stretching.

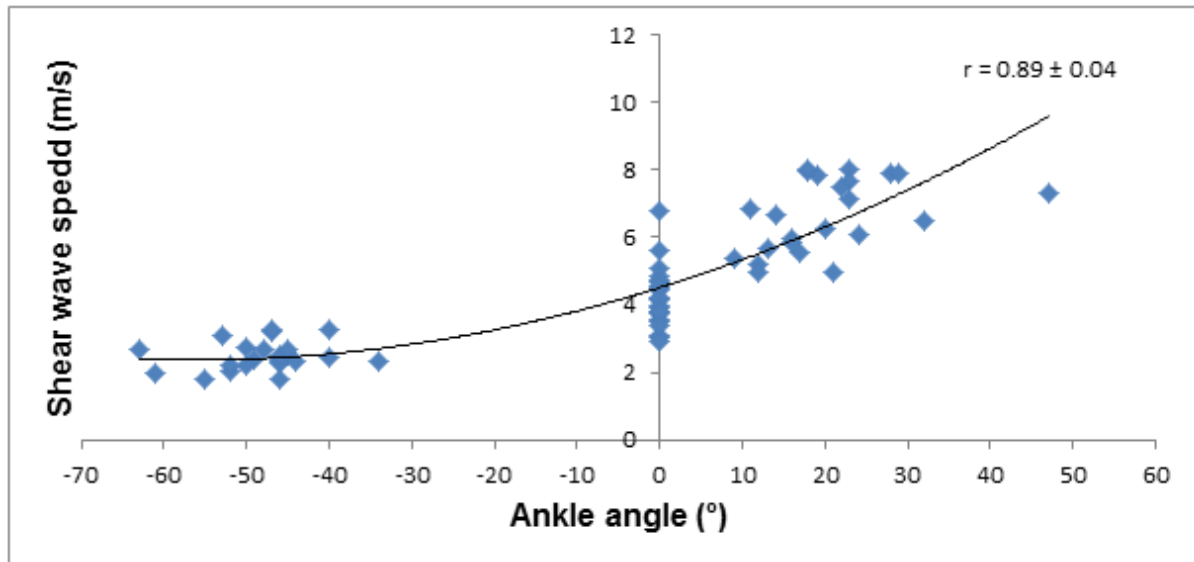

Figure 4.4. Shear wave speed of the MG plotted against fascicle strain post-dynamic stretching.

Muscle Thickness

Muscle thickness at neutral position *possibly* increased from pre- to post measurement in the dynamic stretching protocol ($+4.1\% \pm 2.0$ small effect).

Reliability of Measurements

Overall, the results showed a very good reproducibility (relative and absolute) of this technique at all testing ankle positions (Table 4.4). Neutral position was observed to have the highest relative and absolute reliability than the other three positions (higher ICC and/or lower TE/CV).

Table 4.4. Reproducibility results for n=23. Results for shear wave speed (SWS) at 3 ankle positions and standing

SWS				
Ankle position	Plantarflexion	Neutral	Dorsiflexion	Standing
Mean \pm SD (m/s)	2.51 \pm 0.93	3.81 \pm 0.80	7.66 \pm 1.3	4.19 \pm 0.84
ICC (90% CI)	1.00	1.00	1.00	1.00
TE (m/s) (90% CI)	0.02	0.01	0.02	0.04
CV (%) (90% CI)	1.00	0.40	0.60	2.20

Note: ICC: intraclass correlation coefficient; TE: typical error; CV: coefficient of variation.

Discussion

Joint angle, muscle shear wave speed (at three different positions plus standing) and fascicle strain were assessed *in vivo* before and after an acute dynamic stretching protocol. We found very good reliability of the shear wave speed technique.

Effect of Dynamic Stretching on Flexibility

The acute increase in dorsiflexion angle after the dynamic stretching protocol was 1.5° on average. Recently, an acute increase in dorsiflexion ROM after an acute dynamic stretching protocol was reported to be between 3.1 to 7.3° (Mizuno & Umemura, 2016; Samukawa, Hattori, Sugama, & Takeda, 2011). Interestingly, the acute increase in plantarflexion was 2.3° *likely* beneficial compared to the *possibly* beneficial for dorsiflexion, indicating that the dynamic stretching protocol (contraction of the agonist muscle group-plantarflexors) employed in this study had a greater effect on dorsiflexion in terms of increasing flexibility.

Effect of Dynamic Stretching on Muscle Mechanical Properties

The *likely* beneficial increase in the shear wave speed by 10%, immediately after acute stretching of the MG, may imply that muscle stiffness at neutral position of the ankle increased due to dynamic stretching. A number of previous studies investigated the immediate effect of static stretching only on muscle stiffness of the gastrocnemius (Akagi & Takahashi 2013; Freitas et al. 2015; Taniguchi et al. 2015; Hirata et al. 2016; Nakamura et al. 2014) showing that static stretching decreased the muscle shear modulus, while Nordez et al. (2008) reported no decrease in the MG muscle belly hardness after 10 min of static stretching. Findings suggest that a different mechanism/effect may be responsible for the increased ROM after dynamic stretching. We can speculate that there might be a decrease in tendon stiffness after dynamic stretching which has caused the *possibly* increased passive dorsiflexion ROM. In other words, opposite effects of dynamic stretching on the muscle and

tendon tissues might occur in response to dynamic stretching and result in an overall increase in the muscle-tendon unit compliance.

Additionally, our results differ from those reported in previous studies in which dynamic stretching was employed as a treatment intervention (Herda et al., 2013; Mizuno & Umemura, 2016). Mizuno and Umemura (2016) found that dynamic stretching (contraction of the antagonist) did not change the mechanical properties of the muscle-tendon unit (stiffness) and attributed the change in ROM to enhanced stretch tolerance, whereas Herda et al. (2013) reported that the increase in the ROM after four 30 s sets of dynamic stretching, consisting of contraction of the agonist muscle group (knee flexors) was due to a decrease in the muscle-tendon unit stiffness. These results differ from the above where muscle stiffness was inferred from the passive torque-angle curve and a combination of dynamometry and ultrasonography. These discrepancies may be explained by the fact that passive torque recorded via dynamometry technique is influenced not only by muscular but also by non-muscular structures. The connective tissue, and in particular the perimysium, is considered to be a major extracellular contributor to the overall recorded passive stiffness (Purslow, 1989) in those studies. The ultrasound shear wave elastography scanner used in the present study can quantify localised tissue stiffness, and we excluded the effect of outside connective tissues (epimysium, fascia, and aponeurosis) from the analysis of shear wave speed data. Additionally, measurement of individual muscle properties is difficult using dynamometry and measurement of the passive torque is also affected by the synergistic muscle activity, tissue composition and articular structure (Maïsetti et al., 2012). The method employed in the present study, i.e. shear wave elastography, allows quick and easy evaluation of the passive properties of individual muscles *in vivo* (Lacourpaille et al., 2012).

After the dynamic stretching, there was a decrease in muscle fascicle strain compared to the pre-stretching situation, and the increase in the overall elongation of the muscle-tendon unit may be attributed to the relatively increased contribution from the tendon. It should be emphasised that we did not measure tendon properties directly, but since the tendon strain is dependent on the muscle fascicle strain considering that the muscle fascicle and the tendon are aligned in series (Kay &

Blazevich, 2009; Morse et al., 2008), therefore a decrease in fascicle strain will imply an increase in the tendon strain. This agrees with findings of our first study of decreased muscle strain and increased tendon strain after two acute bouts of dynamic stretching of different velocities. A future study should consider simultaneous measurements of the tendon properties to clarify the present results.

Importantly, the present results suggest different changes in the acute muscle vs. tendon mechanical properties through different stretch types, which might have implications for dynamic muscle function and movement performance either in a sports or clinical settings. The decrease in muscle strain caused by the dynamic stretching protocols may indicate microtrauma to the cytoskeleton-membrane and accompanying sarcomere disruption during eccentric exercise giving rise to Ca^{2+} levels in muscle fibres (Whitehead, Weerakkody, Gregory, Morgan, & Proske, 2001). This, in turn, can trigger low-level activation and produces 'contracture clots', which increase muscle passive tension (Morgan & Allen, 1999) by increasing cross-bridge formation and may lead to high (resting) stiffness.

A recent study suggested that early increases in muscle shear wave speed after exercise could reflect the perturbation of calcium homeostasis induced by cytoskeletal alterations (Lacourpaille et al., 2014). Although a direct relationship with the increase in shear wave speed is not clearly established, a 28% increase in MG shear wave speed after eccentric exercise suggests that the MG might have been damaged by the eccentric exercise protocol (Guilhem et al., 2016).

Several studies have reported increased muscle stiffness immediately after repeated eccentric muscle contractions (Chleboun, Howell, Conatser, & Giesey, 1998; Howell, Chleboun, & Conatser, 1993). Agten et al. (2017) reported an immediate increase in shear wave speed after eccentric exercise which was explained by extracellular muscle oedema and increased blood flow due to the exercise rather than DOMS. Increased perfusion with exercise in our study might have produced 'pseudohypertrophy' of the muscle as indicated by the *possible* increased muscle thickness post-dynamic stretching. Metabolic factors may contribute to this because ATP is required to detach myosin from actin during cycles of muscle contraction (Spudich, 2001). With ATP loss during exercise, this detachment capacity decreases and the two proteins remain connected. Therefore,

ATP loss may be another reason for the increased stiffness observed in shear wave speed.

This work supports current evidence that shear wave speed for the MG is positively associated with the ankle angle and fascicle strain (Chernak, DeWall, Lee, & Thelen, 2013; Lee et al., 2016; Maïsetti et al., 2012). However, such increase in shear wave speed with increasing joint angle and fibre strain does not imply increased stiffness *per se*, and for such conclusion to be made, shear wave speed should be recorded pre- and post-intervention at comparable joint angle.

There are some limitations to consider when interpreting the results of the study. We did not directly measure muscle activity throughout the passive dorsiflexion and plantarflexor movement to ensure that the muscles remained passive. However, the fact that the participants were instructed to stay relaxed throughout the testing procedures, and that we monitored fascicle length using B-mode ultrasonography and made sure that it stayed constant at the end ROM of passive ankle movements indicated that the muscle was quiet during the shear wave speed passive measurements. In isotropic homogenous materials, shear wave speed is directly related to Young's modulus (Royer, Gennisson, Deffieux, & Tanter, 2011), but this is not necessarily true in tissue which is transversely anisotropic (Royer et al., 2011), i.e. muscle. It is shown that shear wave speed is related to the Young modulus in muscle (Eby et al., 2013) and provides a reliable measurement of the resting state muscle (Lacourpaille et al., 2012) but such relationship is unclear in passive and active measurements. Muscle is also anisotropic, viscoelastic and heterogeneous, which violates common assumptions needed to convert shear wave speed to shear modulus and Young's modulus (Equation 1). Therefore, we decided to report our values in shear wave speed. Furthermore, shear wave speed cannot differentiate which factors may contribute to the increased stiffness such as the extracellular matrix, intracellular proteins, or reflexively mediated activity (Lee et al., 2016). A recent publication has shown that skin is the main contributor (among the tissues covering skeletal muscle) to the maintenance of muscle mechanical properties, contributing up to 50% to muscle shear modulus and that epimysium has no effect on muscle stiffness (Yoshitake, Miyamoto, Taniguchi, Katayose, & Kanehisa, 2016). We can speculate that with any intervention we can change no

more than 50% of the factors influencing muscle stiffness. Another limitation is that shear wave speed measurement was only performed at only one region of the muscle. Therefore, it is unclear whether the current findings can be generalised for the entire muscle region. Further research is needed to clarify this.

Reproducibility of Shear Wave Speed Measurements Using Ultrasound Shear-Wave Elastography

The reproducibility of measuring shear wave speed in the gastrocnemius was determined to be excellent because the ICC was 1.00, with TE 0.01-0.04 m/s and CV 0.40-2.20% respectively. Previous studies have suggested that shear wave elastography could be considerably affected by the pennation angle (Gennisson et al., 2010; Maïsetti et al., 2012). Nevertheless, Miyamoto et al. (2015) showed that the effect of pennation angle on shear wave speed was negligible when the pennation angle was 20° or less.

Conclusions

Using shear wave elastography, we have demonstrated that dynamic stretching increases shear wave speed in the MG resting muscle at the neutral ankle position. This suggests that mechanical properties of the MG may have altered, as evidenced by the greater stiffness but also decreased muscle fascicle strain, and increased thickness measured using B-mode ultrasound. Results of the present study suggest a differential effect of dynamic stretching on muscle and tendon tissues which can be beneficial to not only athletes and trainers but also to clinicians in choosing which treatment interventions might be ideal depending on the underlying muscle-tendon impairment or requirement of the sport.

Chapter 5 Influence of Dynamic Stretching on Ankle Joint Stiffness, Vertical Stiffness, and Running Economy during Treadmill Running

Introduction

Pre-warm-up activities are widely used in sports events to prepare the body for optimum performance (Bishop, 2003b). Active warm-up, such as dynamic stretching, is one of the most commonly used techniques by distance runners because it is likely to induce cardiovascular changes contributing to distance running performance (Bishop, 2003b). Recently, research has been focused on various other factors which can be affected by dynamic stretching and may alter oxygen uptake $\dot{V}O_2$ kinetic responses, lactate threshold and running economy (i.e., rate of oxygen uptake at any given velocity) (Moore, 2016) which can affect performance. Running economy has been shown to be a useful predictor of endurance running performance (Alexander, 1977; Anderson, 1996; Conley & Krahenbuhl, 1980; Costill, Thomason, & Roberts, 1973; Daniels, 1985; Morgan, Baldini, Martin, & Kohrt, 1989), especially in athletes homogeneous for $\dot{V}O_{2\max}$ (Conley & Krahenbuhl, 1980; Costill et al., 1973; Morgan et al., 1989). Accordingly, biomechanical and physiological properties of the muscle-tendon unit, such as muscle morphology and elastic elements, and joint mechanics which can be affected by dynamic stretching, and affect running economy (Joyner & Coyle, 2008; Saunders, Pyne, Telford, & Hawley, 2004) may have a role in improving endurance performance.

Running economy can be affected by the way the body segments move (running biomechanics) (Novacheck, 1998) which in turn may determine how effectively muscles consume available energy (Saunders et al., 2004). In general, smaller vertical oscillation of the centre of mass (COM), greater leg stiffness, smaller lower limb moment of inertia, alignment of the ground reaction force (GRF) and leg axis vectors, smaller leg extension at toe-off, larger stride angles (achieved by either increasing swing time or decreasing stride length), maintenance of the arm swing, lower muscle activation during propulsion, lower antagonist–agonist co-activation of the thigh muscles (Moore, 2016), lower energy cost of trunk muscles to maintain stability of the trunk during running (Craib et al., 1996), and greater storage and

return of the elastic energy (Jones, 2002) during SSCs are all associated with higher running economy. Furthermore, a strong association between running economy and long-distance performance has been reported as a key factor in the great success of African runners in endurance events (Saltin et al., 1995). As the running biomechanics are greatly determined during the ground contact, factors that affect the propulsion phase may have the strongest links with running economy. Therefore, training routines that can modify the mechanics of running during the propulsion phase may alter the energy cost of running.

During forward propulsion, large moments are generated at the major joints of the lower limb, but ankle plantar flexor moment plays a more prominent role in achieving better running performance (Novacheck, 1998). During running, the ankle joint generates and transfers the mechanical power required for forward propulsion. Hence, mechanical and morphological properties of the ankle musculature are likely to be related to running economy and endurance performance (Arampatzis et al., 2006; Fletcher, Pfister, & Macintosh, 2013; Hunter, Katsoulis, & McCarthy, 2011; Kubo, Miyazaki, Yamada, et al., 2015; Kubo, Tabata, Ikebukuro, Igarashi, Yata, et al., 2010; Kubo, Miyazaki, Shimoju, & Tsunoda, 2015; Kubo, Tabata, Ikebukuro, Igarashi, & Tsunoda, 2010). For example, increased stiffness of the musculotendinous unit has been considered a desirable trait for long distance runners through the higher use of elastic energy during the SSC (Wilson & Flanagan, 2008), although it also has the potential to increase the risk of injury and inhibit an athlete's performance in the early stages of a race. However, there is evidence both for and against increased muscle-tendon unit stiffness and running economy when comparing runners with similar $\dot{V}O_2\text{max}$ values (Arampatzis et al., 2006; Kubo, Tabata, Ikebukuro, Igarashi, Yata, et al., 2010), as explained below.

According to some studies (Albracht & Arampatzis, 2013; Arampatzis et al., 2006), more economical runners (i.e., those with higher running economy) display a greater plantarflexor muscle strength and triceps surae tendon stiffness due to a reduced energy consumption by the muscles. If tendon-aponeurosis stiffness affects the metabolic energy cost during running, it could be due to the improved energy storage and release of the in-series elastic component (Blickhan, 1989; McMahon & Cheng, 1990). A higher energy storage and release would reduce the work done by

the contractile element during the propulsion phase (Alexander & Bennet-Clark, 1977; Roberts, 1997). Kyröläinen and Komi (1994) found that stiffer muscles surrounding the ankle and knee joints caused a force potentiation when transitioning from the braking to the propulsion phase of running, thereby improving running economy.

During the eccentric (absorption) phase of ground contact (initial contact to mid-stance phase), an athlete stores mechanical energy in the elastic tissues of the leg (Alexander & Bennet-Clark, 1977). During this phase, the tendon is stretched, and stores strain energy. A portion of this energy is returned during the subsequent shortening (acceleration) phase (from mid-stance to terminal stance and through the initial swing), thereby reducing the work required during the muscle contraction (Cavagna, Dusman, & Margaria, 1968; Voigt, Bojsen-Møller, Simonsen, & Dyhre-Poulsen, 1995). In the subsequent (concentric) period, stored elastic energy is released and contributes to the body's next movement, reducing overall energy expenditure (J. Fletcher, Esau, & MacIntosh, 2010; Pearson & McMahon, 2012). Accordingly, it may be argued that a more compliant tendon will store more elastic energy and, conversely, that a stiffer tendon and aponeurosis would increase the metabolic energy cost during the propulsion phase of running. Indeed, a number of studies (Kubo, Tabata, Ikebukuro, Igarashi, Yata, et al., 2010; Kubo, Miyazaki, Shimoju, et al., 2015; Kubo, Tabata, Ikebukuro, Igarashi, & Tsunoda, 2010) reported that a lower leg stiffness was related to superior running performance as assessed by personal best time and running economy.

Stiffness of the muscle-tendon unit is, however, determined by the relative stiffness of its constituent components, i.e., muscle and tendon. In addition to increasing flexibility (range of motion), dynamic stretching decreases passive joint stiffness (Herda et al., 2013) and causes proximal displacement of the musculotendinous junction of the head of the medial gastrocnemius when the participants are standing still (Samukawa, Hattori, Sugama, & Takeda, 2011) indicating lengthening of the tendon tissues which subsequently may affect the running economy of a person. Alterations in ROM and muscle-tendon unit mechanical properties in response to dynamic stretching, therefore, affect running economy in a way which is not easy to predict. For a task involving the SSC, an

optimal tendon stiffness for power output and efficiency exists (Alexander & Bennet-Clark, 1977; Butler, Crowell, & Davis, 2003). Subsequently, stretching to increase flexibility may result in less than optimal joint mechanical properties, i.e., whereby muscle energy requirement is minimised (J. Fletcher, Groves, Pfister, & MacIntosh, 2013). Another possible mechanism for a lower flexibility contributing to higher running economy is when running economy is associated with shorter muscle fascicles and shorter muscles which use less energy when the velocity of shortening is not important (J. Fletcher & MacIntosh, 2017). Therefore, there is a delicate balance between flexibility of the muscle-tendon unit and its mechanical properties (muscle and tendon components) after dynamic stretching, and physiological response of the performer as determined by the running economy.

Dynamic stretching by definition consists of controlled, rhythmic, repeated movements through the active range of motion to the point of tension and return to full inner position incorporating sports-specific movements which prepares the athlete's body for activity (I. Fletcher & Jones, 2004). It is known that dynamic stretching decreases passive joint stiffness (Herda et al., 2013) and/or increases motor unit activation (Cramer et al., 2004; I. Fletcher, 2013; Hough, Ross, & Howatson, 2009; Torres et al., 2008), thereby altering the SSC performance, but dynamic stretching does not change vertical stiffness during running (Pappas et al., 2017). Furthermore, dynamic stretching induces post- PAP. Post-activation potentiation increases the efficiency of muscle contraction by lowering the threshold for recruitment of motor units (Katch, McArde, & Katch, 2011), by increasing the rate of cross-bridge formation (Haff & Triplett, 2016) and firing frequency (Layec et al., 2009) inducing acute improvements during running, sprinting and weightlifting activities (Hodgson, Docherty, & Robbins, 2005; Tillin & Bishop, 2009).

Despite the common belief among athletes that greater flexibility may result in greater running economy, the effect of stretching and subsequent increased flexibility on running economy is equivocal. An acute static stretching protocol was reported not to affect running economy (Allison, Bailey, & Folland, 2008; Hayes & Walker, 2007; Lowery et al., 2014; Mojock, Kim, Eccles, & Panton, 2011), although both beneficial (Godges, MacRae, Longdon, Tinberg, & Macrae, 1989) and detrimental effects of static stretching on endurance performance have also been reported

(Wilson et al., 2010). On the other hand, fewer studies have investigated the effect of dynamic stretching on endurance performance.

To date, only three studies, have examined the effects of dynamic stretching on running economy. Hayes and Walker (2007) compared the acute effects of controlled velocity dynamic stretching on running economy at an intensity of 75% $\dot{V}O_2\text{max}$ in well-trained distance runners. They found that slow velocity dynamic stretching did not acutely change running economy. Zourdos, Wilson and Sommer (2012) studied how dynamic stretching affected male runners over a 60-min run. The researchers found that dynamic stretching of the lower extremities was correlated with a statistically significant increase in the energy (caloric) expenditure during treadmill running for 30 min at 65% $\dot{V}O_2\text{max}$ compared to a non-stretch condition. Yamaguchi and Takizawa (2015) recently investigated the effects of dynamic stretching at a velocity equivalent to 90% $\dot{V}O_2\text{max}$. Dynamic stretching acutely prolonged the time to exhaustion but did not affect running economy. Yamaguchi and Takizawa (2015) considered that the differences between the findings in these three studies (Hayes & Walker, 2007; Yamaguchi et al., 2015; Zourdos et al., 2012) were attributed firstly to differences in the dynamic stretching protocols and exercise intensities during the assessment of performance. However, it is not known whether a change in muscle-tendon unit stiffness or improvement in neuromuscular activation was altered by dynamic stretching and caused the above effects in running economy. A dynamic warm-up may increase flexibility due to an increase in muscle compliance, whereas static stretching increases flexibility due to a decrease in muscle-tendon unit stiffness, causing an increase in the slack of the muscle-tendon unit caused by muscle and tendon creep, which impairs subsequent performance (Carter & Greenwood, 2015).

Based on the previously reported links between muscle-tendon unit stiffness and running economy, and the influence that a specific intervention such as stretching may have on stiffness, the aim of this study was to determine whether stiffness (derived using inverse dynamics) and PAP (assessed by EMG) could positively or negatively influence running economy during an incremental treadmill exercise test (evaluated by online gas analysis). While dynamic stretching decreases passive muscle-tendon unit joint stiffness assessed using dynamometry,

its influence on joint stiffness and vertical stiffness, and kinematic and kinetic variables during actual running as possible mechanisms which can affect running economy has not been thoroughly investigated. Therefore, the purpose of the study was to examine the acute effect of a dynamic stretching protocol on running economy, in order to inform future warm-up protocols. It is speculated that that dynamic stretching will acutely decrease the joint and vertical stiffness, and hence, increase running economy measured as $\dot{V}O_2$ during treadmill running.

Methods

Participants

Twelve male recreational runners (age: 27.3 ± 4.4 years; height: 1.80 ± 0.05 m; body mass: 70.0 ± 0.1 kg) volunteered to participate after reading an information sheet and signing an informed consent form. They were given detailed information about the purpose and methods used in the present study. All participants were Brunel University London student or staff and were unfamiliar with the testing protocol. They were informed that they could withdraw from the study at any time. The study was approved by the Ethics Committee for Undertaking Research Projects of Brunel University London. Each participant was tested at a consistent time of the day (± 1 h) and was asked to maintain a consistent lifestyle (similar diet and no unaccustomed exercise) between the visits. Participants were informed to finish their meals 2 hours before the experiments. They were instructed to report to the laboratory well hydrated, rested, and having completed no strenuous exercise within the previous 48 hours before the testing sessions and were prohibited from drinking alcohol and caffeine within the last 24 hours and 6 hours respectively. Participants were included in this study if they were healthy and did not have a history of musculoskeletal injury during the previous six months.

Study Design

A crossover/repeated measures experimental design was used, thereby eliminating issues of inter-group variability such as strength, prior stretching knowledge and experience. Participants acted in both control and treatment conditions, thus eliminating the influence of confounding variables which could affect the outcomes such as the extent of random biological variations (age, etc.) together with effects such as learning. Furthermore, the design reduced the chance of type II errors that could occur. The participants visited the laboratory on two occasions, separated by 2-14 days in order to avoid any potential carry-over effects. At the first visit, the participants undertook either the dynamic stretching (treatment condition) or the control condition (no stretching). The pre-runs period involved either dynamic stretching or no stretching in a randomised counterbalanced order. Each participant was tested at the same time of the day and wore the same shoes for both the dynamic stretching and control conditions. The independent variables were two conditions (dynamic stretching and control). The dependent variables were joint stiffness, vertical stiffness, joint moments, joint angles and $\dot{V}O_2$.

Anthropometry

Body mass was measured using an analogue balance scale (Seca Vogel & Halke GmbH & Co, Hamburg, Germany) to the nearest 0.1 kg, and height was recorded to the nearest 1 cm using a stadiometer (Marsden Leicester Height Measure, Marsden Weighing Group, Rotherham, UK).

Dynamic Stretching and Control Condition Interventions

For the dynamic stretching condition, each participant wore unrestricted clothing and stood on a step. The participants started on the balls of both feet with the heels raised and then lowering them in a controlled manner. The exercise was performed on the edge of the step to allow full dorsiflexion to be reached. The stretching exercise was performed at 100 beats per min (MetroTimer 3.3.2, ONYX 3

Apps, Sofia, Bulgaria) 3 sets of 20 repetitions with a 5-sec rest in between each set (Figure 5.1). Medial gastrocnemius was the target muscle for the stretching protocol since during the stretching active plantarflexion (concentric contraction of MG), and dorsiflexion (eccentric contraction of the MG) ensured contraction of the “agonist” muscle group (ankle plantarflexors). The participants were instructed to move into full plantarflexion and dorsiflexion during the protocol. The control condition involved participants sitting quietly for additional 50 s, which was equal to the duration of the dynamic stretching protocol, after collecting the heart rate and breath-by-breath gas-exchange at rest.

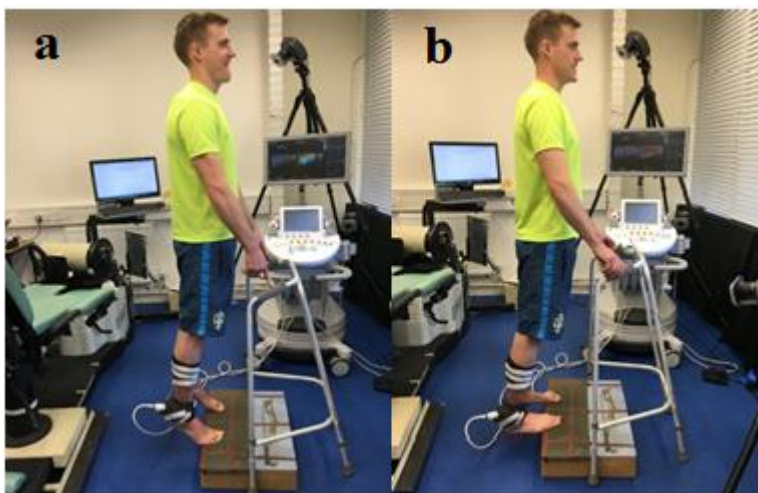

Figure 5.1. a. Start and finish position standing erect on the step. b. Position at full stretch. Participants were instructed to lower their body at the desired speed and return to the starting position which was controlled by the application of an auditory cueing using a metronome.

Motion Analysis

Joint kinematics and kinetics during running were measured using a 10-camera motion capture system (Motion Analysis Corporation Inc., Santa Rosa, CA., USA) synchronised with a treadmill with dual integrated force plates capable of capturing X, Y and Z force components (Bertec Corporation, Columbus, OH, USA). The experimental set up used is illustrated in Figure 5.2.



Figure 5.2. Laboratory set-up with the lab-coordinate system during participant testing.

Spherical retro-reflective markers were placed on the sacrum (mid-posterior superior iliac spine (PSIS), and bilaterally on the anterior superior iliac spine (ASIS), greater trochanter, lateral femoral epicondyle, medial femoral epicondyle, lateral malleolus, medial malleolus, on the shoe at the location of the heel (calcaneus), and the 2nd and 5th metatarsal heads. Tracking markers were placed on thighs (2) and shanks (2). The skeletal model defined has a precise definition that can be followed to create any number of segments within a model. Two rules should be followed to allow Visual3D to calculate the six-degrees of freedom motion of every segment using optimal techniques. The two basic rules are: (a) at least 3 tracking markers must be attached to each segment and recorded during the movement trial; and (b) a standing trial must identify four static markers that represent medial and lateral locations at the proximal end of the segment and the medial and lateral locations at the distal end of the segment.

The standing calibration trial was collected during quiet standing with the arms horizontally abducted with the feet pointed forward such that the long axes of the feet were parallel to the “X-axis” of the laboratory coordinate system.

The foot model for the foot segment was defined as a single rigid body. Three non-collinear markers were attached directly to the shoe to define the motion of the foot segment reflective markers were placed at the following points: the first metatarsal head, the fifth metatarsal head; and the posterior aspect of the heel counter of the shoe (proximal calcaneus).

The centre of the ankle joint was taken to be the midpoint between the apices of the lateral and medial malleolus. The calcaneus, the first metatarsal head and the fifth metatarsal head were used as anatomical points to represent the skin cluster for dynamic motion tracking for the foot segment.

The shank segment model was adopted from that described by Cappozzo, Catani, Della Croce, and Leardini (1995). The centre of the knee joint was taken to be the midpoint between the femoral epicondyles. The shank segment was defined as a rigid body structure. The proximal knee joint position was defined by lateral and medial epicondyle markers. The distal end of the shank was defined by the lateral and medial malleolus positions. Markers placed on the shank, the lateral epicondyle, lateral and medial malleolus were used as anatomical points to represent the skin cluster for dynamic motion tracking for the shank segment during the movement trials.

The thigh segment was defined by the position of the thigh anatomical markers relative to the knee joint centre. The proximal anatomical landmark was the hip joint centre. To locate the greater trochanter, it was required to detect movement of one segment relative to another segment - in this case, the thigh relative to the pelvis. The distal end of the thigh was defined as the centre of the knee joint (based on the position of the lateral and medial epicondyles). Hip joint landmark markers placed on the leg, lateral epicondyle, were used as anatomical points to represent the skin cluster for dynamic motion tracking for the shank segment during the movement trials.

Pelvis was created according to the CODA coordinate system using markers which were placed on the anterior superior iliac spine (ASIS) and the sacrum (mid-PSIS). The hip joint centre was automatically calculated using CODA pelvis. For dynamic motion tracking of the pelvic segment, calibration targets were used. Figure 5.3 illustrates the lower body model which was built in Visual3D using this method.

The definition of the anatomical-segment coordinate system used to determine the 3D position, and orientation of the lower extremity and pelvic segments was a combination of anatomical-frame conventions proposed previously (Cappozzo et al., 1995).

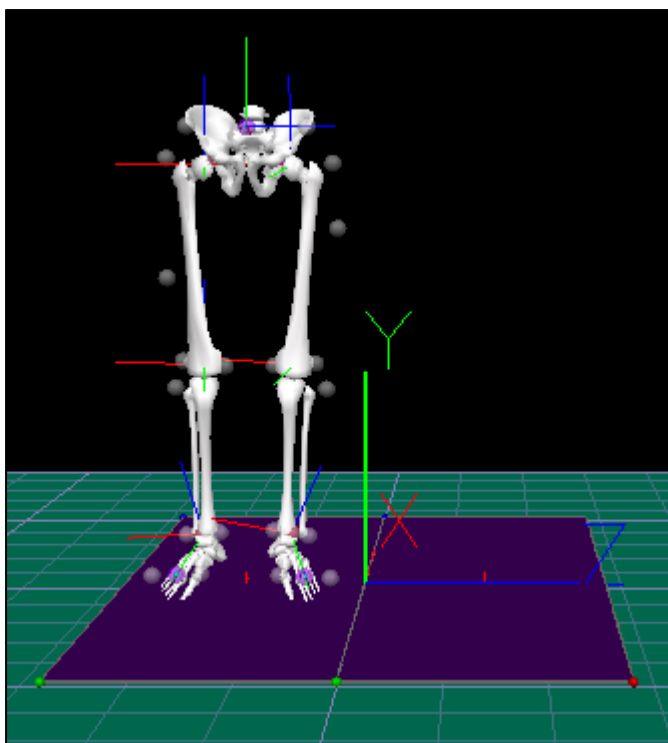

Figure 5.3. An example of the lower body model in Visual3D used for this research

Motion data were collected at 150 Hz, and ground reaction forces were obtained from the force plate at 2100 Hz. Participants run at set speeds according to the maximum incremental exercise test. Five running trials were collected, and the average of these trials was used in the analysis. Joint angles were calculated using a right-hand rule with Cardan rotational X-Y-Z sequence to describe the motions of the distal segment relative to the proximal segment. Rotations about the X-axis

corresponded to flexion/extension, about the Y-axis corresponded to abduction/adduction, and about the Z-axis corresponded to the internal/external rotation. This convention is frequently used to describe lower extremity rotation (Cappozzo et al., 1995).

Ankle sagittal joint angle was calculated as the deviation from the anatomical position, normalised to standing posture to be able to define plantarflexion/dorsiflexion by subtracting the ankle angle value at the standing position from the raw kinematic data.

Joint kinematics were calculated using inverse kinematics and net joint moments were calculated using a standard inverse-dynamics approach and were normalised to body mass using Visual 3D software (C-motion, Germantown, MD, USA). The external moments acting on the ankle joint were expressed in the ankle joint coordinate system of the anatomical model as this has been suggested to be the best option for a standardised system as it represents what a joint moment actually is (Schache & Baker, 2007). Gait events were determined using force platform data from heel strike [otherwise known as initial contact] to toe off to enable calculation of kinematics, ankle moments and EMG data during the stance phase of gait. The force platform system used was factory-calibrated, but manual zeroing was also performed before each testing session by pressing the calibration button when there was no load acting on the force plates to ensure that the reading was equal to zero.

The force platform was used to measure the GRF or body's response to gravitational forces as participants ran across it. The ground reaction vector (GRV) magnitude was calculated as:

$$\text{GRV} = \sqrt{F_x^2 + F_y^2 + F_z^2}$$

The gait laboratory coordinate system was different from that recommended by The International Society of Biomechanics (ISB). For the purpose of this study, the gait laboratory was set up as follows (see Figure 5.2):

- X-axis in the anterior-posterior and positive pointing backwards

- Y-axis in the axial (vertical) direction and positive pointing upwards
- Z-axis in the medial-lateral direction and positive pointing to the left.

Marker trajectories were low pass filtered at 6 Hz, and ground reaction force data were filtered at 30 Hz using a 4th order zero-lag Butterworth low pass filter as determined by visual inspection. Each stance phase of the gait cycle (the time points between heel strike to toe-off) was time normalised to 101 points (Zeni, Richards, & Higginson, 2008). Heel strike events were determined when the vertical ground reaction force crossed a threshold of 20 N for a period of at least 0.05 s while toe-off was defined as the point after initial contact at which the vertical ground reaction force fell below 20 N for a period of at least 0.05 s. All kinematic and kinetic variables of interest for the ankle, including peak angles, maximum ROM and peak joint moments, were calculated for the right leg for all participants.

Dynamic Joint Stiffness

Calculation of vertical stiffness is based on the assumption that the human body can be modelled as a global spring-mass system (Butler et al., 2003), which does not take into consideration the properties of individual joints that contribute to the summative stiffness (Pearson & McMahon, 2012). Therefore, it is important to consider the contribution of the stiffness of individual joints which may be affected by the dynamic stretching protocol.

Dynamic joint stiffness of the ankle joint was calculated during the running cycle. Dynamic joint stiffness (DJS) was defined as the change in joint moment (ΔM) normalised to body mass divided by the change in joint angle ($\Delta\theta$):

$$DJS = \frac{\Delta M}{\Delta\theta}$$

Dynamic joint stiffness was determined using a torsional spring model (Butler, Davis, & Hamill, 2006; Gabriel et al., 2008; Lamontagne, Malouin, & Richards, 2000; Lark, Buckley, Bennett, Jones, & Sargeant, 2003), and calculated as the slope of the ankle moment-angle plot during the propulsion phase of stance (loading response to toe-

off). For all biomechanical variables, the average of 5 running cycles at the initial running speed collected after 30 s into the first running stage was used in the statistical analysis.

Vertical Stiffness

Vertical stiffness is a representative measure of the summative musculoskeletal stiffness of the lower limb, approximating how the lower limb-spring deforms in response to force during a vertical displacement (Butler et al., 2003). It is a quick and easy method by which to assess the viscoelastic properties of the lower limb (Butler et al., 2003).

Vertical stiffness (K_{vert}) was calculated as the peak vertical ground reaction force (F_{max}) divided by the vertical displacement of the pelvis between initial contact and peak vertical ground reaction force (Δy).

$$K_{vert} = \frac{F_{max}}{\Delta y}$$

Vertical stiffness was corrected by multiplying the calculated values by a correction factor of 1.0496 (Coleman, Cannavan, Horne, & Blazeovich, 2012).

Custom-made software (Matlab 2013a, MathWorks, Natick, MA, USA) was used to calculate dynamic joint stiffness and vertical stiffness using the original dataset (i.e., not time normalised) as described by Farley and Morgenroth (1999) and Powell, Williams, Windsor, Butler, and Zhang (2014).

Exercise Protocol

Participants started running on the treadmill after 2 minutes from dynamic stretching, which was defined as the minimum period between warm-up and start of a game/training session, used by previous authors (Chaouachi et al., 2010; I. Fletcher & Jones, 2004; I. Fletcher & Monte-Colombo, 2010; Little & Williams, 2006; Wong, Chaouachi, Lau, & Behm, 2011). The participants performed a submaximal

incremental ramp protocol to the limit of tolerance on a motorised treadmill (Bertec Corporation, Columbus, OH, USA). The initial speed was 2.3 m/s, followed by increments in speed of 0.2 m/s every 3 min. To determine peak oxygen uptake ($\dot{V}O_{2peak}$), two of the following criteria were met: (a) voluntary exhaustion, and (b) heart rate within ± 10 beats of age-predicted maximum.

Online Gas Analysis

Pulmonary gas exchange was measured at rest for 6 min and continuously during the exercise protocol via a portable metabolic system (Cosmed K5, Rome, Italy). The system consists of a mask, heart rate monitor, and a collection unit that wirelessly transmits data to a laptop where it can be observed in real time. The Cosmed K5 gas analysers (O_2 and CO_2) were calibrated before each session by using ambient air and a gas mixture of known concentration (5% CO_2 , 16% O_2 , balance N_2) according to the manufacturer's recommendations. The turbine flow meter, a bidirectional turbine with an optoelectronic reader, was calibrated with a 3-L syringe (Cosmed Srl, Rome, Italy). The volume and concentration signals were time aligned, accounting for the transit delay in capillary gas and analyser rise time relative to the volume signal. The wearable equipment was positioned on the participant, and the bidirectional turbine was attached to a facemask (Hans Rudolph Inc., Shawnee, KS, USA) covering both the mouth and the nose (Figure 5.4). Participants breathed through the low-dead-space mask, with air sampled at $200 \text{ ml}\cdot\text{min}^{-1}$. Breath-by-breath $\dot{V}O_2$ data were initially examined to exclude errant breaths caused by coughing, swallowing, etc. and breath-by-breath data were averaged over 5 breaths. Those values lying more than 3 SD from the local mean were removed. $\dot{V}O_2$, carbon dioxide output ($\dot{V}CO_2$), and respiratory exchange ratio (RER) values were quantified over the final 30 s of each stage of the submaximal protocol.



Figure 5.4. Attaching the Cosmed K5 on one of the participants for pulmonary gas collection.

Calculation of Running Economy

First, participants were asked to remain seated and still to obtain metabolic cost measures for seated rest. The 30 s average $\dot{V}O_2$ was determined during the final minute of each stage. Running economy was established by plotting oxygen uptake on the y-axis and speed on the x-axis, then the method of least squares was used to establish the extent to which the data conform to the expected linear relationship, with the production of linear regression equation (Cooke, 2001). For each participant, the minimum number of stages completed before $\dot{V}O_{2peak}$ between the two conditions (dynamic stretching and control) was used. The number of stages used to construct individual participant regression equations ranged from 4 to 8. This has been found to be accurate (Control: R^2 , 0.96; SEE, 0.088 ml.kg⁻¹.min⁻¹; Dynamic stretching: R^2 , 0.94; SEE, 0.097 ml. kg⁻¹.min⁻¹). To investigate the time course of changes in $\dot{V}O_2$ values over the range of speeds/numbers of stages in maximum incremental exercise test, we have included the stages that were completed by all participants.

Electromyography

Electromyography (EMG) was recorded using three Trigno Wireless electrode sensors (Delsys Inc., Ltd., Boston, USA), which had a predetermined bandwidth filter of 20–450 Hz, a gain of 1000, a common mode rejection ratio of > 80 dB, and a sampling rate of 2000 Hz. Each wireless EMG electrode contains a built-in pre-amplifier and two sets of parallel silver contact bars with a fixed distance of 1 cm between the recording sites. One set of contact bars served as a reference electrode. Each interface electrode was oriented in the direction of the muscle fibre, over the MG, SOL and TA muscles according to SENIAM guidelines for electrode positions (Hermens et al., 1999; Merletti, Farina, Frericks, & Harlaar, 1999; Stegeman & Hermens, 1998). The skin of the electrode site was prepared by shaving, gentle abrasion using an abrasive gel (Nuprep, D.O. Weaver, USA), and cleansing with an alcohol tissue wipe (Robinson Healthcare, Worksop, UK). Specially designed double-sided tape (Delsys Inc., Ltd., Boston, USA) was applied to the electrodes and attached to the muscle sites. The electrodes were fixed on the skin using a hypoallergenic elastic latex-free tape. The EMG signal was collected at a sampling rate of 2100 Hz and stored for off-line analysis. All EMG data were visually inspected prior to analysis. EMG signals that were not usable were excluded from the analysis. EMG data for each gait cycle were exported from Visual 3D and imported into Spike2 software (Cambridge Electronic Design, Cambridge, UK) for further analysis. EMG raw signal was notch filtered at 50 Hz (to remove ambient noise from power supply), rectified and smoothed using a 5-data point moving average window (Spike2, Cambridge Electronic Design, Cambridge, UK). The EMG amplitude for each muscle was calculated as the RMS value over the 5 stance cycles (from initial contact to toe-off).

Statistical Analysis

Descriptive statistics are reported as means and SDs. Data analysis was undertaken using a post-only crossover trial with adjustment for a predictor spreadsheet (Hopkins, 2006). The effect size, which represents the differences between conditions, was calculated from log-transformed and subsequently back-

transformed data, with 90% CI reported as estimates of uncertainty to quantify the magnitude of the difference between pre-intervention and post-intervention outcome performance measures (Hopkins, Marshall, Batterham, & Hanin, 2009). This is suggested to be the appropriate method for quantifying changes in athletic performance (Hopkins et al., 2009). Dependent variables were analysed either as log-transformed data [All physiological measures, ankle joint stiffness, vertical stiffness, moments and EMG amplitudes] or raw data [ROM, angles] (Hopkins, 2015). In athletic performance research, it has been argued that it is not whether an effect exists but how big the effect is that matters and the use of the P-value alone provides no information about the direction or size of the effect or the range of feasible values (Hopkins et al., 2009). The threshold value for the smallest worthwhile change was set at 0.2 of the between-subject deviation for all measures and the probability that the true value of the effect was greater than the SWC was calculated and interpreted qualitatively. To assess the real-world relevance of the data, the magnitude of the effect size for the measures was classified as trivial (<0.2), small (0.2-0.6), moderate (0.6-1.2) or large (1.2-2.0), very large (2.0-4.0) and extremely large (>4.0) via standardised thresholds (Hopkins et al., 2009). Non-clinical inference was based on the disposition of the 90% CI for the mean difference to this smallest worthwhile effect; the probability (percent chances) that the true population difference between trials was substantial (beneficial/detrimental) or trivial was calculated as per the magnitude-based inference approach (Batterham & Hopkins, 2006). Where the 90% CI overlapped the thresholds for the smallest worthwhile change in both positive and negative sense, the true effect was classified as unclear. In the event that a clear interpretation was possible, these percent chances were qualified via probabilistic terms assigned using the following scale: <0.5%, most unlikely or almost certainly not; 0.5–5%, very unlikely; 5–25%, unlikely or probably not; 25–75%, possibly; 75–95%, likely or probably; 95–99.5%, very likely; and >99.5%, most likely or almost certainly (Hopkins et al., 2009).

Reliability of Measurements

The repeatability/reproducibility of ankle joint stiffness and vertical stiffness was determined from the values obtained from 5 gait cycles. To this end, the intraclass correlation coefficient ICC, and the TE of joint stiffness and vertical stiffness were calculated for 5 gait cycles using a reliability spreadsheet (Hopkins, 2015). This spreadsheet provides pairwise analyses of consecutive trials (Trial 1 v Trial 2, Trial 2 v Trial 3, Trial 3 v Trial 4, Trial 4 v Trial 5) to assess habituation and measurement reliability properly. To derive the within-subject variation as a CV, data were log-transformed (100 x natural logarithm) before analysis using the Hopkins' (2000) spreadsheet. In order to interpret the magnitude of the TE, TE was doubled before assessing it on the scale below (Atkinson & Batterham, 2015; T. Smith & Hopkins, 2011). Typical error was calculated and interpreted using a modified Cohen's scale where < 0.2 = trivial, $0.2-0.6$ = small, $0.6-1.2$ = moderate, $1.2 - 2.0$ = large and > 2.0 = very large error) (Hopkins et al., 2009). For a description of relative reliability, intraclass correlation coefficients (ICC_{3,1}; Shrout & Fleiss, 1979) were determined using the same spreadsheet, with ICCs with qualitative inference based on the following thresholds: >0.99 , extremely high; $0.99-0.90$, very high; $0.75-0.90$, high; $0.50-0.75$, moderate; $0.20-0.50$, low; <0.20 , very low respectively (Malcata, Vandenberghe, & Hopkins, 2014). Uncertainty in all estimates was set at 90% confidence limits throughout.

The usefulness of the tests was determined by comparing TE to the smallest worthwhile change for the ankle joint and vertical stiffness (Hopkins, 2004). It is important to understand that in tests where the TE is greater than the SWC, the test is considered as not sensitive, as the detection of biological change is not possible due to the associated error in measuring the test. If the TE was below the SWC, the test was rated "good"; if the TE was similar to SWC, the test was rated "acceptable"; and if the TE was higher than the SWC, the test was rated "marginal".

Results

The before and after stretching values with mean differences, effect size and qualitative non-clinical inferences based on post-only crossover trial analysis are shown in Table 5.1.

Table 5.1. Descriptive statistics and mean differences in the Control and dynamic stretching (DS) performance measures along with effect size and qualitative inferences.

	Control	DS	Mean Change; 90%CL	Effect Size	Likelihood (%) of DS being beneficial/trivial/detrimental	Qualitative Inference
Physiological Measures						
Overall Running Economy – regression equation gradient (mL/min/kg/m/s)	3.46 ± 0.87	3.34 ± 0.96	-4.0 ± 8.3	-0.15 ± 0.32	4/58/39	Possibly beneficial
$\dot{V}O_2$ – y-intercept (m·kg ⁻¹ ·min ⁻¹)	35.24 ± 5.52	35.30 ± 3.99	+0.8 ± 3.3	+0.04 ± 0.18	7/91/2	Likely trivial
$\dot{V}O_2$ (1 st stage) (mL·kg ⁻¹ ·min ⁻¹)	39.53 ± 4.29	38.59 ± 4.23	-2.0 ± 4.3	-0.16 ± 0.36	5/52/43	Possibly beneficial
$\dot{V}O_2$ (2 nd stage) (mL·kg ⁻¹ ·min ⁻¹)	42.95 ± 5.41	42.85 ± 5.36	0.0 ± 2.6	0.0 ± 0.19	4/91/4	Likely trivial
$\dot{V}O_2$ (3 rd stage) (mL·kg ⁻¹ ·min ⁻¹)	46.65 ± 5.32	46.52 ± 5.62	4.0 ± 26.2	0.31 ± 2.00	54/14/32	Unclear

	Control	DS	Mean Change; 90%CL	Effect Size	Likelihood (%) of DS being beneficial/trivial/detrimental	Qualitative Inference
$\dot{V}O_2$ (4 th stage) (mL·kg ⁻¹ ·min ⁻¹)	49.11 ± 5.50	48.57 ± 5.81	4.7 ± 31.6	0.38 ± 2.45	55/11/34	Unclear
Biomechanical Measures						
Joint Stiffness (Nm·kg ⁻¹ ·deg. ⁻¹)	0.067 ± 0.030	0.060 ± 0.033	-10.7 ± 16.1	-0.20 ± 0.31	2/49/49	Possibly decrease
Vertical Stiffness (N·m ⁻¹)	23195 ± 2483	22708 ± 2990	-2.3 ± 4.3	-0.20 ± 0.37	4/46/50	Possibly decrease
Peak Plantarflexion Moment (Nm·kg ⁻¹)	1.62 ± 0.14	1.68 ± 0.18	+2.1 ± 5.7	+0.22 ± 0.60	53/36/12	Unclear
Dynamic ROM (deg.)	32.18 ± 3.65	31.88 ± 3.82	-0.3 ± 1.0	-0.08 ± 0.27	5/54/21	Unlikely decrease
Peak Plantarflexion Angle (deg.)	-14.00 ± 4.16	-15.36 ± 5.27	-1.4 ± 2.2	-0.30 ± 0.49	5/31/64	Possibly increase
Peak Dorsiflexion Angle (deg.)	18.16 ± 2.84	16.81 ± 4.83	-1.4 ± 2.4	-0.44 ± 0.78	8/21/71	Unclear
Ankle Angle at Initial Contact (deg.)	5.37 ± 3.59	3.24 ± 5.77	-2.1 ± 2.5	-0.55 ± 0.66	3/15/82	Likely decrease
Ankle Angle at Toe-Off (deg.)	-13.93 ± 4.27	-14.79 ± 5.55	-0.9 ± 2.2	-0.19 ± 0.48	9/43/48	Unclear

	Control	DS	Mean Change; 90%CL	Effect Size	Likelihood (%) of DS being beneficial/trivial/detrimental	Qualitative Inference
EMG RMS (MGM) (V)	0.18 ± 0.25	0.10 ± 0.04	-27.1 ± 39.2	-0.38 ± 0.15	0/3/97	Very likely decrease
EMG RMS (SOL) (V)	0.12 ± 0.06	0.11 ± 0.04	-16.3 ± 20.9	-0.23 ± 0.49	7/39/54	Unclear
EMG RMS (TA) (V)	0.08 ± 0.03	0.07 ± 0.04	-8.6 ± 19.6	-0.19 ± 0.40	6/49/44	Unclear

Note. Physiological measures and Biomechanical measures are reported as log-transformed data except for peak plantarflexion moment dynamic ROM, peak ankle and dorsiflexion angles, ankles at initial contact and toe-off which are reported as raw data.

Physiological Measures

Dynamic stretching resulted in a *possible* benefit in overall running economy (economy over a wide range of running speeds) (gradient) (-4.0% ± 8.3; trivial effect) and a *likely* trivial change in the y-intercept of the running economy graph (0.04% ± 0.18, trivial effect). There was a *likely* trivial effect in $\dot{V}O_2$ during the first stage of the protocol (-2.0% ± 4.3; trivial effect) indicating increased running economy, a *likely* trivial change (0.0% ± 2.6, trivial effect) indicating no change in running economy at the second stage, and unclear effects at the third and fourth stage between the dynamic stretching and the control condition (Figure 5.5).

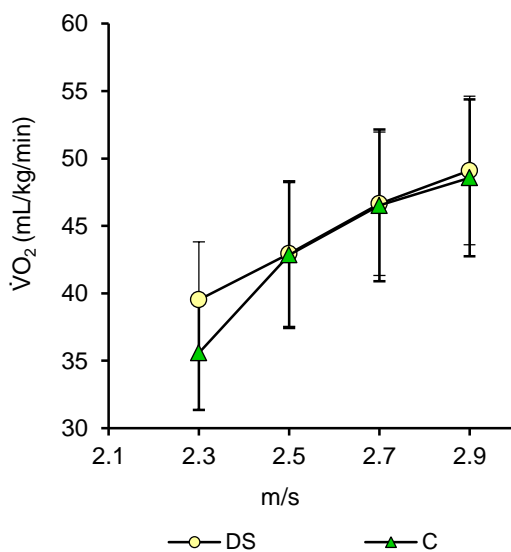

Figure 5.5. $\dot{V}O_2$ ($\text{mL kg}^{-1} \text{min}^{-1}$) to running speed relationships, for the Dynamic stretching (DS) and Control (C) condition for the first four stages.

Biomechanical Measures

Dynamic stretching resulted in a *possible* decrease in joint stiffness ($-10.7\% \pm 16.1$; small effect) and a *possible* decrease in vertical stiffness ($-2.3\% \pm 4.3$; small effect). The effects of dynamic stretching on plantarflexion moment normalised to body mass were unclear, although there was a 2.1% increase. The dynamic stretching intervention showed an *unlikely* decrease in dynamic ROM ($-0.3^\circ \pm 1.0$; trivial effect).

From a kinematic point of view, there was a very likely decrease in ankle angle at the initial contact ($-2.1^\circ \pm 2.5$; moderate effect) while the effect on ankle angle at toe-off was unclear (Table 5.1). Dynamic stretching resulted in a *possible* increase in peak ankle plantarflexion angle ($-1.4^\circ \pm 2.2$; small effect) and an unclear effect on peak ankle dorsiflexion angle.

There was a *very likely decrease* in MG RMS ($-27.1\% \pm 9.2$; small effect) while there was a decrease in both SOL and TA RMS, although this result was unclear.

Repeatability of Stiffness Measures

ICCs analysis revealed high values for dynamic joint stiffness and vertical stiffness relationships, but moderate TE. The TE was below the SWC for joint stiffness and vertical stiffness indicating good reliability. Table 3.2 shows mean, SD, TE and 90% lower and upper confidence limits and SWC.

Table 5.2. Repeatability results for Joint Stiffness and Vertical Stiffness* (n = 12 participants).

	Joint	Vertical
Mean ± SD	0.070 ± 0.035	22042 ± 2630
ICC (90% CI)	0.76 (0.59 – 0.90)	0.83 (0.69 – 0.93)
Qualitative Inference	High	High
TE (90% CI)	1.06 (0.44 – 0.66)	0.90 (0.38 – 0.56)
Qualitative Inference	Moderate	Moderate
SWC	10.65	1.53
Rating	Good	Good

Note. *TE reflects noise in test scores generated from biological and technological sources. SWC represents the smallest change that is of benefit to athletic performance.

Discussion

This study aimed to understand potential effects of an acute dynamic stretching protocol during a maximum incremental test on running economy, ankle joint dynamic and vertical stiffness in recreational athletes. The primary finding was that dynamic stretching elicited *possibly* better overall running economy (gradient of $\dot{V}O_2$ – speed graph; -4.2%) and reduction of $\dot{V}O_2$ during the first stage (-2.0%) indicating better running economy, and likely trivial change during the second stage (0.0%), while during the third stage and fourth stage the effect on $\dot{V}O_2$ was unclear. This suggests that the time course of the effect of dynamic stretching has occurred during the first stage. However, the effect of dynamic stretching protocol was enough to *possibly* decrease the gradient of the regression line. The data also revealed that dynamic stretching *possibly* decreased ankle joint and vertical stiffness running at a speed of 2.3 m/s (first stage). The dynamic ankle and vertical stiffness decreased after dynamic stretching. During running after dynamic stretching, the ankle plantarflexion ROM was higher than control. This higher ankle ROM provides a mechanistic explanation for the lower dynamic ankle joint stiffness in dynamic stretching. These results are in agreement with the findings of (Kubo, Tabata, Ikebukuro, Igarashi, & Tsunoda, 2010) who found that those participants with decreased lower limb properties (tendon stiffness) had better running economy. These findings suggest that an acute dynamic stretching protocol altered lower extremity joint kinematics and kinetics and physiology of neuromuscular functions (EMG RMS) during running.

Up to now, the detail mechanisms of changes in running economy because of a stretching protocol are unknown. To our knowledge, this is the first study to demonstrate an improvement in running economy following a dynamic stretching protocol by exploring the possible mechanisms behind it such as reducing lower limb stiffness using a maximum incremental $\dot{V}O_2$ protocol. However, this study did not aim to establish a relationship between dynamic joint stiffness, vertical stiffness and running economy since physiological and biomechanical data were not collected synchronously during the protocol at the same time point in the current study.

Physiological findings were in contrast with other studies (Hayes & Walker, 2007; Yamaguchi et al., 2015; Zourdos et al., 2012). Hayes & Walker (2007)

compared the effects of 5 exercises of dynamic stretching of the lower extremities for 2 sets of 30 seconds at a controlled slow velocity, to static and progressive static stretching for 2 sets of 30 seconds and non-stretching, on running economy ($\dot{V}O_2$) during constant-speed treadmill running for 10 min at 75% $\dot{V}O_{2max}$. They found no change in running economy, suggesting that different stretching techniques did not acutely affect running economy. However, the authors attributed the inconsistent change in performance to the addition of a 10-min submaximal warm-up run prior to performance testing which could have reversed the reductions in neuromuscular performance and therefore not impacting running economy. Additionally, the number of participants was small ($n=7$) and the running economy was measured during the last 3 minutes of a 10-minute run.

Submaximal running or a general warm-up has been previously shown to reverse the reduction in neuromuscular performance after a period of static stretching (Hayes & Walker, 2007; Taylor, Sheppard, Lee, & Plummer, 2017). Additionally, Zourdos et al. (2012) found that by performing 2 sets of 4 repetitions of 10 dynamic stretching exercises of the lower extremity muscles acutely increased energy expenditure by 4.4% during treadmill running at an intensity of 65% $\dot{V}O_{2max}$ for 30 min compared to non-stretching. The dynamic stretching raised the participants' resting heart rate, $\dot{V}O_2$, and metabolism before the run. However, this increase in the temperature and metabolic demand may not be beneficial to endurance performance (Bishop, 2003b). It has been suggested that an effective endurance activity warm-up supplements or maintains body temperature increases prior to exercise (Bishop, 2003b). In this study, (Zourdos et al., 2012), therefore, the dynamic stretching protocol may have been too long thereby negatively affecting the results. If the intensity and duration are too high or too long (>10 min), the warm-up can be detrimental to performance (Bishop, 2003b). The warm-up must increase $\dot{V}O_2$ while also avoiding premature fatigue and increase in body temperature (Zourdos et al., 2017). Yamaguchi et al. (2015) examined the effect of dynamic stretching on 5 lower limb muscles of one set of 10 repetitions performed as quickly as possible and found no effect on oxygen uptake at 90% $\dot{V}O_{2max}$. Two reasons for the differences in the outcomes of the above studies compared to this study need to be considered.

First, the dynamic stretching protocols used in the above studies (Hayes & Walker, 2007; Yamaguchi et al., 2015; Zourdos et al., 2012) were considerably different than the current study in terms of repetitions, sets and the velocity of dynamic stretching, which might have an effect on $\dot{V}O_2$. Secondly, there were differences in the exercise intensities when assessing running economy. In the current study, for each participant, all of the stages completed before $\dot{V}O_{2peak}$ was chosen for analysis. Comparing baseline $\dot{V}O_2$ (y-intercept) at the start of the incremental treadmill exercise test between the dynamic stretching and the control condition, it is *likely* trivial that the dynamic stretching condition caused a change in the baseline oxygen consumption thus rejecting that elevated oxygen consumption before the task as one of the factors contributing to the improved performance as suggested by Bishop (2003b).

The other mechanism(s) causing the change in running economy is thought to be a change in the properties of the muscle-tendon unit and/or a change in motor unit activation as a consequence of the stretching procedure (Fletcher & Anness, 2007). This is supported by the current results which suggest a small decrease in joint and vertical stiffness as a contributor to the *possibly* improved running economy. Recently, Pappas et al. (2017) investigated the effects of dynamic stretching on vertical stiffness during running and showed that vertical stiffness was not altered, which contradicts the current findings. Herda et al. (2013) reported a decrease in muscle-tendon unit stiffness following four 30 s sets of dynamic stretching which agrees with the current findings. One possible reason for the discrepancy in the stiffness between the present study and Pappas et al. (2017) may be the inclusion of a different dynamic stretching protocol in their study (5-min warm-up at 2.22 m/s, number of lower leg muscles stretched, duration of stretching on each muscle- two 20 s bouts, and the higher running speed 4.44 m/s).

The increased joint and vertical stiffness following dynamic stretching may be attributed to the physiological factors associated with a more active warm-up (Fletcher, 2010). Another possible reason for the enhanced performance following dynamic stretching may be the rehearsal of more task-specific movement patterns of our protocol, such as dorsiflexion-plantarflexion, which match the movement patterns and velocity of the running task (Fletcher & Jones, 2004). Results from the EMG

analysis indicated that dynamic stretching caused a small decrease in MG RMS during the gait cycle, and although the effects on Sol and TA RMS values were unclear, there was a tendency for a decrease. Activation of more motor units in a given condition of the lower limbs is one potential mechanism for increasing $\dot{V}O_2$ and would be expected, therefore, to be detrimental to running economy (Kyröläinen, Belli, & Komi, 2001). Greater muscle activation requires more oxygen to activate, control movement patterns and stabilise joints, thus a higher $\dot{V}O_2$ and worsening running economy (Moore, 2016) which did not happen in this study. A decrease in joint stiffness allows for improved energy storage and return (Cavagna, Citterio, & Jacini, 1981). Also, the less muscle activation for running at a given speed could theoretically result in a reduction in energy expenditure (Kyröläinen et al., 2001; Moore, 2016).

Caution should be exercised when extrapolating the findings of this study to trained male athletes because we only tested male recreational runners. Even though the participants were of above-average aerobic fitness ($\dot{V}O_{2\max} \geq 40$ ml/kg/min) (Jackson et al., 1995; Riebe, Ehrman, Liguori, & Magal, 2018), and as indicated by Shellock & Prentice (1985) elite athletes may need longer warm-ups to prepare properly, suggesting that more trained individuals will need a longer warm-up because of their thermoregulatory centre would be more efficient to responding to exercise-generated heat. Additionally, the negative relationship between energy cost and flexibility in men does not seem to be present in female athletes (Beaudoin & Whatley Blum, 2005). Furthermore, stiffness values are 29% lower in women compared to men (Granata, Wilson, & Padua, 2002). As stiffness plays a major role in performance and energy (oxygen cost) and is a major variable affected acutely by stretching, it is conceivable that men and women may respond differently to our measured variables.

Stiffness of the muscle-tendon unit is determined by the relative stiffness of its constituent components, i.e., muscle and tendon. The findings of musculoskeletal modeling studies (Hof, Elzinga, Grimmius, & Halbertsma, 2002; Sasaki & Neptune, 2006) and cadaveric studies (Alexander & Bennet-Clark, 1977; Ker, Bennett, Bibby, Kester, & Alexander, 1987) showed that the lower metabolic energy expenditure by muscle fibers during walking and running was associated with the elastic energy

stored in the Achilles tendon, we may assume that our protocol may have affected tendon stiffness. During the concentric phase (propulsion phase) of running, the rapid shortening of tendon structures plays a role in lowering the velocity of muscle fibres (Kawakami, Muraoka, Ito, Kanehisa, & Fukunaga, 2002; Kubo, Kanehisa, Kawakami, & Fukunaga, 2000), and having lower stiffness in the plantar flexors after dynamic stretching is suitable for storing higher elastic energy at the stance phase during running, which can further contribute to achieving higher performance.

Limitations

Oxygen uptake of the whole body was measured during our maximum incremental test and examined the changes in dynamic joint and vertical stiffness. However, it can be argued that the differences found in the mechanical properties of the muscle-tendon units are caused by dynamic stretching; stiffness may be responsible for the differences in running economy between the two conditions. It was assumed that the triceps surae muscles are the main contributors to the energy expenditure while running. Early studies (Arampatzis, Knicker, Metzler, & Brüggemann, 2000; Winter, 1983) that have analysed submaximal running by inverse dynamics reported that during running the muscles acting around the ankle joint contribute <60% to the total mechanical work. Based on these studies, which rely on inverse dynamic analyses, it is reasonable to assume that the ankle joint muscle-tendon unit may be representative of the energy expenditure of submaximal running. It cannot be excluded that individual differences in the moments/forces between participants could exist and could influence the calculated stiffness values.

Daily variation of running economy could have an impact on the results. However, our testing protocol was similar to the suggestions by Morgan, Martin, Krahenbuhl, and Baldini (1991) who demonstrated that group measures of running economy are reliable across two treadmill running sessions of male non-elite runners are tested the same time of the day, wear the same footwear and are not fatigued when testing occurs. Inter-subject variability for both control and dynamic stretching was found to be very good.

Conclusion

The results of this study suggest that dynamic stretching of 3 sets of 20 repetitions at a velocity of 100 beats/min may enhance running economy in recreational runners, possibly by decreasing joint and vertical stiffness. The effect of dynamic stretching has a short time course, but it can improve the overall running economy. Taken together, these results implied that dynamic stretching could be recommended as part of the warm-up. Future research should focus on optimising the dynamic stretching protocol to further influence subsequent performance and test its implications in other participant groups (i.e. elite level athletes, women athletes).

Chapter 6 Neural Correlates of Pain Threshold during Passive Stretching. Is there a Relationship between Pain Tolerance and Increased Range of Motion? – A Pilot Study

Introduction

Stretching is a common practice worldwide in both sports and clinical related settings; used with an aim to improve muscle function, performance and avoid injury (Behm et al., 2015; Magnusson & Renström, 2006). The use of stretching in any form has been shown to result in an increased ROM (McNair & Stanley, 1996), regardless of whether an acute or chronic intervention is used (Behm et al., 2015). Static stretching would seem the most prudent mode of stretching for health-based training within the general non-athletic population and clinical populations since it is considered a safe and effective method to improve overall flexibility (Buckley, 2008). Static stretching consisting of an acute protocol of short stretch duration (5-30 s) (Bandy, Irion, & Briggler, 1997; Kay & Blazevich, 2008) lasting up to a longer, chronic, duration of 12-weeks (180 s for 3 days per week) (Sainz De Baranda & Ayala, 2010) were found to increase ROM in the general sport population. Also, an acute short-term stretching protocol of 100 s duration (Theis et al., 2013) and a chronic of 6 weeks duration (15 min for 4 days per week) (Theis, Korff, & Mohagheghi, 2015) were found to increase ROM in a clinical population with cerebral palsy.

Currently, theories to explain the effects of short or long-term stretching, and the associated increase in ROM, fail to identify the exact mechanism underlying the improvement in flexibility. At present, two mechanisms are proposed in the literature: a mechanical mechanism through a decrease of joint resistance to stretch (joint passive torque at a given angle) that could be due to structural adaptations and a sensory mechanism involving spinal and supraspinal pathways which inhibit α -motoneurons of the stretched muscles (Weerapong, Hume, & Kolt, 2004). Studies that suggest a decrease in the overall muscle-tendon unit stiffness (Kay, Husbands-Beasley, & Blazevich, 2015; Konrad, Stafilidis, & Tilp, 2017), associated passive joint resistive torque (Konrad et al., 2017; Nakamura et al., 2013) and muscle-tendon

elongation (Blazevich et al., 2014) are among the contributing factors to the increased flexibility. Other studies have attributed the increase in ROM after stretching to changes in pain perception, pain tolerance, or a combination of both (Halbertsma, Van Bolhuis, & Göeken, 1996; Magnusson, Simonsen, Aagaard, Dyhre-Poulsen, et al., 1996; Magnusson, Simonsen, Aagaard, & Kjaer, 1996). Stretch tolerance corresponds to the level of discomfort, pain, or feeling of tightness a person is willing to tolerate while stretching (Folpp, Deall, Harvey, & Gwinn, 2006; Law et al., 2009). For example, Magnusson, Simonsen, Aagaard, Dyhre-Poulsen, et al., (1996) assumed adaptations of nociceptive nerve endings may be a possible explanation for the altered stretch tolerance.

From existing studies support for changes to the sensory mechanism that underlie increased flexibility can be observed. Such studies showed that an increase in ROM without changes in the joint resistance to stretch in response to both acute (Halbertsma et al., 1996) (a single stretch training) and chronic short-term interventions (repeated stretching training for 2-8 weeks) (Harvey et al., 2003; Magnusson, Simonsen, Aagaard, Sørensen, et al., 1996). With Björklund et al. (2001) showing that decreased sensation to stretch tolerance was evident after a 2-week stretching protocol of the rectus femoris muscle. Direct measurements of muscle spindle afferents by the same researchers showed reduced activity immediately after large amplitude stretching of the cat hindlimb muscle which may have had an impact on sensory adaptations at the spinal level. At a segmental (spinal) level, inhibition of the stretch reflex would allow a joint to be moved within a wider ROM. Additionally, stretching might cause inhibition or disfacilitation of a muscle via inputs from afferent fibres originating from different non-muscular structures (e.g. tendons, ligaments, joint capsules, skin, nerves, blood vessels etc.) (Nordez et al., 2017).

Stretch reflex is invoked by stimulation of the intrafusal muscle spindles and the inverse stretch reflex is invoked via stimulation of Golgi tendon organs which act as protective mechanisms against joint and musculotendinous injury. Muscle spindle fibres are positioned in parallel with the muscle fibres (Jelvéus, 2011) and are innervated by large group Ia (primary endings) and smaller group II (secondary endings) afferent fibres (Prochazka & Ellaway, 2012). The primary and secondary

muscle spindle endings can sense both dynamic and static changes in muscle length (Prochazka & Ellaway, 2012). When a muscle is rapidly stretched the muscle spindle signals the muscle to contract to prevent it going too far, too quickly in the stretch, and inhibit the opposing muscle, causing it to relax (reciprocal inhibition) allowing the opposing muscle to be stretched.

Golgi tendon organs are located predominantly at the myotendinous junction and are innervated by group Ib afferent fibres (Jami, 1992). These afferent fibres are primarily responsible for detecting changes in the muscle-tendon unit tension. Golgi tendon organs respond as a feedback monitor and discharge impulses under one of two conditions: (1) in response to the tension created in the muscle when it contracts and shortens and (2) in response to tension when the muscle-tendon unit is passively stretched putting the tendon under excessive tension or stretch. In either situation, when Golgi tendon organs receptors are activated they cause an inhibition of the contracting muscles (autogenic inhibition) so muscle-tendon unit stretch can be facilitated. However, in humans, it has been demonstrated that the autogenic inhibition has a duration of just approximately 60 ms which would be insufficient to explain the longer duration inhibitory effects caused by passive stretch (Khan & Burne, 2009; Rogasch, Burne, Binboğa, & Türker, 2011). Thus, presently there is a lack of evidence for the assumption of a significant influence of Golgi tendon organs and muscle spindles to the increased ROM due to their short-term duration.

Notably, different stretching techniques exist, while all have main aim to increase ROM, in both sport and clinical practice, their influence on stretch receptors may be in fact quite different. The application of stretching ranges from slow and sustained static stretching, where a joint is taken to the point of discomfort where tension is felt for a period of time (Garber et al., 2011), to ballistic stretching where the joint is rapidly and repeatedly moved beyond its normal joint ROM. The receptor most likely to mediate the inhibitory effect during static stretching is the muscle spindle type II afferent (Burke, Andrews, & Ashby, 1971) whereas the most likely candidate for the inhibition to the α -motoneuron during the ballistic stretching are the Golgi tendon organs (Eccles, Eccles, & Lundberg, 1957). However, the effect of stretching, as measured by the H-reflex within 2 s after the stretch, showed a considerably depressed H-reflex which fully recovered after 15 s (Budini & Markus,

2016). Therefore, another central mechanism may be responsible for the increased ROM. Recently, Apostolopoulos et al. (2015) suggested that stretching leads to a decrease in muscle-tendon unit stiffness together with adaptations of proprioceptive organs increasing the person's tolerance to stretch.

Although the neural effects of stretching are mostly attributed to structures like muscle spindles, and Golgi tendon organs, the perception and control of pain involving central mechanisms (Vujnovich & Dawson, 1994) may also be likely candidates to explain the increased ROM due to their perspective mechanism of action, as explained below, but such mechanisms appear not to have been studied extensively in humans to date.

Alterations in the supra-spinal drive can affect joint ROM by adjusting the pain threshold and/or pain tolerance level. Pain threshold is typically defined as the minimum noxious stimulus a person perceives as painful mediated by A δ fibres, while pain tolerance is maximum noxious stimulation an individual can tolerate, mediated by C-fibres (IASP Taxonomy Working Group, 2012; Serpell, 2006). Pain impulses are transmitted to secondary afferent neurons in the dorsal horn (peripheral afferent fibres), lateral spinothalamic tract and then to the thalamic nucleus. Third order neurons then ascend from the thalamus to terminate in the somatosensory cortex. Cortical and sub-cortical regions involved in acute pain perception included the primary and secondary somatosensory cortices (S1, S2), anterior cingulate (ACC), insula, thalamus and prefrontal cortex (Figure 6.1) (Apkarian, Bushnell, Treede, & Zubieta, 2005). Alteration in the activity of these regions, which may indicate adaptations to pain in response to stretching, can be identified using non-invasive brain imaging techniques.

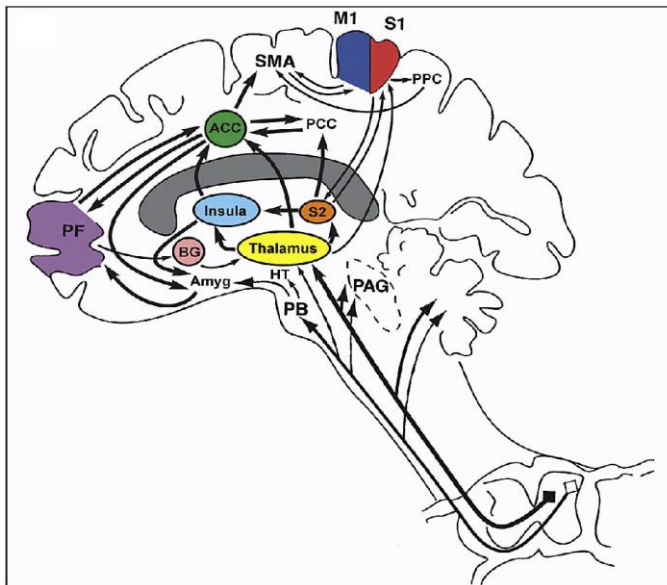

Figure 6.1. Cortical and sub-cortical regions involved in pain perception, their inter-connectivity and ascending pathways. The six areas are the primary and secondary somatosensory cortices (S1, S2, red and orange), anterior cingulate (ACC, green), insula (blue), thalamus (yellow), and prefrontal cortex (PF, purple). Other regions indicated include primary and supplementary motor cortices (M1 and SMA), posterior parietal cortex (PPC), posterior cingulate (PCC), basal ganglia (BG, pink), hypothalamus (HT), amygdala (AMYG), parabrachial nuclei (PB), and periaqueductal gray (PAG). From “Human brain mechanisms of pain perception and regulation in health and disease,” by A. Apkarian, M. Bushnell, R. Treede, and J. Zubieta, 2005, *European Journal of Pain*, 9 (4), p.473. Copyright 2005 by John Wiley and Sons.

Functional magnetic resonance imaging (fMRI) is a tool used to indirectly measure neural activity in the brain that underlies behaviour by measuring changes in the blood-oxygen-level-dependent (BOLD) signal. As a technique fMRI relies on the fact that cerebral blood flow and neuronal activation are closely coupled, such that when neurons in an area of the brain become more active, blood flow to that region increases respectively generating a measurable change in the blood-oxygen-level-dependent (BOLD) signal. This brain-based haemodynamic response function (HRF), serve as a measure of the underlying cognitive, sensory or motor processes.

Studies using fMRI to investigate the effects of stretching upon cortical structures are currently sparse within the literature. Malisza et al. (2003) used fMRI to assess the supraspinal region in anaesthetised rats injected with capsaicin in the ankle joint, and the hind paw followed by ankle joint mobilisation and tried to quantify the response of the hind paw to light touch. A tendency was reported towards decreased activation in brain areas associated with pain processing (anterior cingulate, frontal and somatosensory cortices). Using fMRI Sparks et al. (2013), investigated how pain-free volunteers processed thermal stimuli applied to the hand before and after thoracic spinal manipulation. They observed that after thoracic manipulation, several brain regions demonstrated a reduction in peak blood-oxygen-level-dependent (BOLD) activity – brain regions included the anterior cingulate cortex, insular, amygdala, motor cortex and somatosensory cortices, and the periaqueductal gray.

The possibility of involvement of different brain regions in changing the activity of the α -motoneurons in response to stretching is shown by studies that have used transcranial magnetic stimulation (TMS). Transcranial magnetic stimulation is often used to investigate brain regions where a pulsed magnetic field from a small coil is used to create localised neuron depolarising currents in the cerebral cortex (Barker, Jalinous, & Freeston, 1985). The difference between fMRI and TMS is that TMS can tell us if a specific activation is necessary for a given task. Transcranial magnetic stimulation can also be used to temporarily perturb or disrupt a brain region by turning a targeted or specific area “offline” for a small fraction of a second. In human experiments, it has been demonstrated that changes in muscle length (i.e. towards longer muscle length) of the flexor carpi radialis (FCR) and extensor carpi radialis (ECR) muscles by passively moving the wrist have shown to reduce corticospinal excitability as assessed using TMS (Coxon et al. 2005), suggesting the input from stretch-sensitive afferents might modulate corticospinal excitability (Trajano et al. 2017). It is shown that cortical motor outflow can be influenced by sensory inflow (Matthews, 1991). For example, changes in limb position during a dorsiflexion-plantarflexion task of the ankle using a custom-made manipulandum, have been shown to influence cortical and subcortical structures in a sample of sixteen healthy subjects, all right-foot dominant (Ciccarelli et al., 2005). EMG activity was controlled to make sure the muscle was relaxed during the passive movements. Patterns of

activation during active and passive movements and differences between fMRI responses were assessed. Common activations were found in the contralateral primary and secondary somatosensory cortices. Additionally, it has been observed that the premotor cortical regions (e.g., the bilateral rolandic operculum and contralateral supplementary motor area) and the subcortical regions (e.g., the ipsilateral cerebellum and contralateral putamen) also participate in sensorimotor integration for ankle movements.

In the present study, the effect of static stretching upon the ankle plantarflexor muscles and its associated change in brain activations were investigated, by using an acute stretching protocol in an attempt to identify those sensory mechanisms involved in increasing flexibility. Based on previous studies that used fMRI and TMS for similar purpose, it was hypothesized that structures typically associated with motor execution are likely to show the largest change due to stretching. The brain regions pertinent to this study are the motor cortex, the cerebellum, the basal ganglia, insular cortex, pedunculo-pontine nucleus and the red nucleus, as well as other subcortical motor nuclei. Additionally, it was hypothesized that brain activity both during and following stretching will result in changes in activation of the regions typically associated and most fully described as involved in the processing of pain and perception, such as the insular cortex, the amygdala, periaqueductal grey (PAG), dorsolateral pontine tegmentum (DLPT) and rostroventral medulla (RVM) in the brain stem.

The primary outcome was to measure the immediate change in peak blood-oxygen-level-dependent (BOLD) contrast imaging across brain regions specifically the motor cortex cerebellum and basal ganglia and identify if there were any change in pain perception by using the visual analogue scale (VAS). A priori regions of interest were areas involved in passive movement (contralateral primary motor and sensory cortex (M1, S1), premotor cortex (bilateral rolandic, contralateral SMA), subcortical regions (ipsilateral cerebellum, contralateral putamen), cortical associative areas (bilateral insula, ipsilateral temporal gyrus) (Ciccarelli et al., 2005) and pain perception (primary and secondary somatosensory cortices (S1, S2), anterior cingulate (ACC), insula, thalamus and prefrontal cortex) (Apkarian et al., 2005).

Materials and Methods

Participants

Eleven healthy participants (9 males and 2 females, age 27 ± 3 years, range 22-35 years) were recruited to participate in the experiment. All participants had no history of pain, orthopaedic or systemic conditions; were free of neurological or psychiatric disorders; were not taking medications known to alter brain activity; and had no known history of drug or alcohol abuse. Participants had no contraindication to manual stretching or to undergoing an MRI exam, these included claustrophobia, the presence of a cardiac pacemaker, cochlear implants, metal implants, implanted hearing aids, previous injuries caused by bullets or shrapnel, pregnancy, or thinking that they might be pregnant.

All participants gave their written informed consent prior to participation in the study recognizing that they could withdraw at any time without prejudice. This research was approved by Brunel University Research Ethics Committee and was in accordance with the ethical standards established by the 1964 Declaration of Helsinki.

Experimental Setup

Each participant lay in the supine position in the scanner while instructions were back-projected using a PowerPoint presentation shown through a small mirror directly in front of the participant. Instructions presented were information about the stretching procedure with stretching angles and durations on the scanner screen. Participants were required to lie down on a wooden board modified to accommodate an adjustable incline calf stretch, offering different stretch angles. The right leg was fastened onto the board with the knee joint fully extended, using straps positioned on the thigh, shank and ankle. Two straps were also placed over the foot in order to secure and fixate the foot position and minimise unwanted limb and joint movement during the experiment. Participants were provided earplugs, and their head was positioned inside the head coil, comfortably secured and partially restrained with

padded headrests to provide support and minimise head movement throughout the experiment (Figure 6.2).



Figure 6.2 The experimental set-up used in the study before inserting the straps on the lower legs to secure the participant.

Experimental Design and Timing

The experimental paradigm consisted of a single event-related design with two different stretch durations of 30 or 60 s. Each stretching period was followed by a 15 s-readjustment period so that the experimenter could manually readjust the stretch angle. The position of the right foot at the start of the task was neutral. The PowerPoint presentation gave specific instructions to when the experimenter was to adjust the angle manually.

fMRI data were continuously acquired through the experiment while participants viewed a PowerPoint presentation with instructions. Participants were instructed to stay relaxed throughout the experiment. The participant was not able to see what was happening during the experiment other than the information displayed on the presentation screen via the head coil mirror system. Tactile information was

given to the participant by the experimenter as he was manually adjusting the ankle angle. The ankle joint was stretched at each of the following ankle joint angles of 0°, 15° and maximum stretch tolerance were taken according to our protocol (see diagram below).

Before starting the experimental MRI session, a practise session was conducted to familiarise participants with the experimental paradigm and setup. Then the experimental procedures were performed as follows:

Stretch at 90° degrees ankle joint position for 60 s, readjustment of the foot plate (15 s), foot plate at 15° (60 s), foot plate readjustment (15 s), maximum ROM stretch (30 s), foot plate readjustment (15 s), stretch at maximum ROM (60 s), foot plate readjustment (15 s), stretch at 90° degrees ankle joint position (60 s), readjustment of the foot plate (15 s), foot plate at 15° (60 s), foot plate readjustment (15 s), maximum ROM stretch (30 s), foot plate readjustment (15 s). Scanning procedure is shown in figure 6.3.

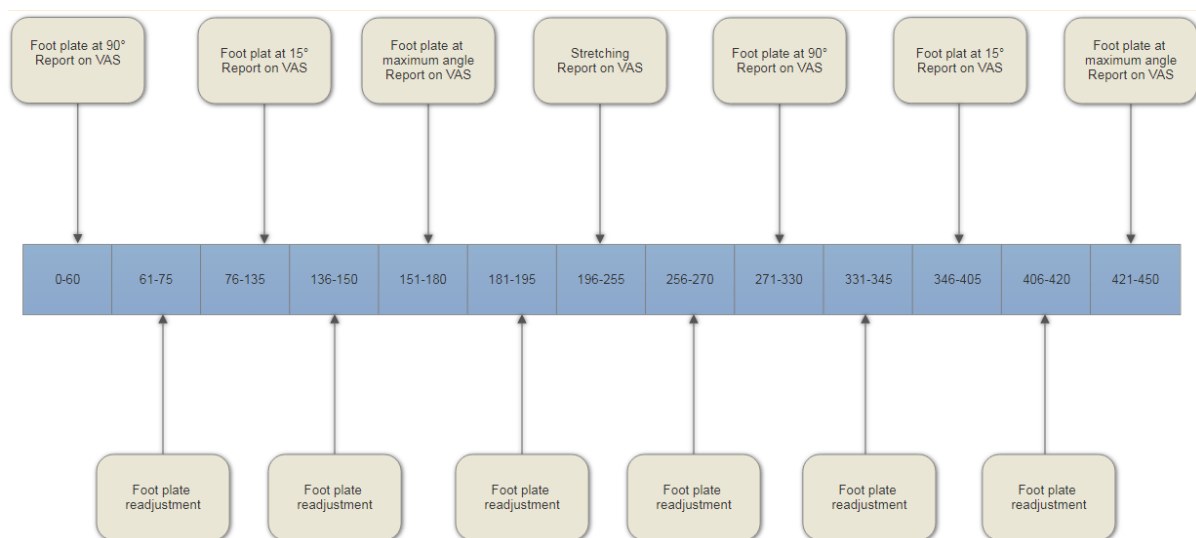

Figure 6.3. Schematic of the data collection procedure. Information about the stretch timings and the progress of the protocol was shown through a small screen directly in front of the participant. Judgments of the participants perceived pain discomfort for the 3 stretching angle settings was assessed using the visual analogue scale of

pain (VAS) using a control with buttons (1 = “no pain”, 9 = “strongest pain imaginable”) during the brain scans.

Pain Perception

During the experiment, participants were asked to rate pain perception discomfort they experience during each of the 3 stretching angle settings using the visual analogue scale of pain (VAS) by using a control with buttons during the brain scans (1 = “no pain”, 9 = “strongest pain imaginable”. Information was displayed on the back-projected screen. Participants gave feedback once the question was displayed.

MRI Data Acquisition

The experiment was conducted using a 3T MRI scanner (Magnetom Trio, Siemens, Erlangen, Germany) with an 8-channel array head coil system. The run consisted of 270 T2*-weighted EPI volumes (slice thickness = 3 mm, 44 slices ascending acquisition, TR = 3.00 s, TE = 30 ms, flip angle = 85°, FOV= 64 mm × 64 mm, 64 × 64 matrix) acquired in transverse orientation for blood-oxygen-level-dependent (BOLD)-based imaging and an acceleration factor of 2 with generalized autocalibrating partially parallel acquisitions reconstruction (GRAPPA). Each volume comprised 32 contiguous (no gap) slices acquired with a roughly parallel alignment with respect to the anterior-to-posterior commissure (ACPC) line. For anatomical reference, an anatomical image was collected for each participant using a high-resolution T1-weighted MP-RAGE sequence (TR = 1.9 s, TE = 30.03 ms, flip angle: 11°, FOV = 256 mm × 256 mm, 256 × 256 matrix, 176 sagittal slices, slice thickness 1 mm).

fMRI Data Analysis

Pre-processing and whole brain analysis

Image analysis was performed using Statistical Parametric Mapping software (SPM12, Wellcome Department of Imaging Neuroscience, London, UK; <http://www.fil.ion.ucl.ac.uk/spm/>) implemented in MATLAB 2016b (MathWorks, Inc.; Natick, MA) and WFU Pickatlas (Wake Forest University, Winston-Salem, NC; <http://www.ansir.wfubmc.edu/>). Statistical tests were corrected for whole brain multiple comparisons using a Family Wise Error (FWE) rate of $p < 0.05$. When FWE correction was not possible, whole brain comparisons were corrected on the cluster level using a whole brain threshold of $p < 0.001$ and a cluster size as specified by SPM.

Each EPI volume was realigned to the first image in the sequence to correct for head movements during the experiment; the anatomical T1 volume was then co-registered to the mean EPI image. The anatomical T1 was then manually co-registered with the Montreal Neurological Institute template (MNI-T1) to accommodate the tilted head position, the same manipulation was applied to all functional images; subsequently, the T1 scan was segmented and spatially normalized to match the MNI-T1 template distributed with SPM12 using the unified segmentation and normalization procedure; the resulting transformation parameters were applied to the functional images. The normalised EPI images were smoothed with an isotropic 6 mm full width at half maximum (FWHM) Gaussian filter.

The fixed-effects first-level analysis of the individual participants' imaging data included the removal of low-frequency drifts in the data using a high pass filter with a cut-off period of 128 s and a correction for temporal autocorrection in the data was applied using an autoregressive AR (1) process as implemented in SPM12.

The first and last 5-10 s of each condition were discarded in an effort to ensure the attainment of stable signal level but also to ensure synchronization between the manual adjustment of the ankle and the PowerPoint Presentation. The timings of the six experimental conditions were identified using time intervals Pre 0° (10-54 s), Pre 15° (84-128 s) Pre Max (158-182 s), Post 0° (277-321 s), Post 15° (351-395 s) and Post Max (425-449 s). Contrast images of Pre 15° > Pre 0°, Pre

Max > Pre 0°, Post 15° > 0°, Post Max > 0°, Pre 15° > Post 15°, and Pre > Post Max were calculated for all participants.

After estimation of the general linear model (GLM), specific effects of the experimental conditions within each participant were tested by applying linear contrasts to the parameter estimates of the events of interest. Contrast images obtained from the first level analysis were used for paired t-tests for a voxel-wise whole brain analysis between conditions.

We constructed a group mean brain by calculating a voxel-wise average of all normalized T1-weighted brain volumes for the illustration and anatomical localization of the results. Then group level statistics were used to reveal significant activations over the total group of the 11 participants. All findings and regions of interest coordinates are reported in a standard stereotactic reference space (MNI, Montreal Neurological Institute).

Group statistics were calculated:

1. One sample t-tests were used to investigate main effects across the six conditions on the group level.
2. The T-contrast images of Pre 15° > Pre 0°, Pre Max > Pre 0°, Post 15° > Post 0°, Post Max > Post 0°, Pre 15° > Post 15°, and Pre > Post Max were used to calculate a T-test on group level (results at $p < 0.001$, cluster-wise correction).

Brodmann's areas (BAs), in which significant clusters were identified using the Wake Forest University Pickatlas (Maldjian, Laurienti, & Burdette, 2004; Maldjian, Laurienti, Kraft, & Burdette, 2003) using coordinates of the most significant voxel (x,y,z mm). For illustration, we plotted FWE corrected activation maps onto the canonical Montreal Neuroimaging Institute (MNI) 152 template brain image (Evans, Collins, & Milner, 1992), and onto a three-dimensional-rendered template brain image using MRICron software (www.mccauslandcenter.sc.edu/crnl/mricron/) (Rorden & Brett, 2000).

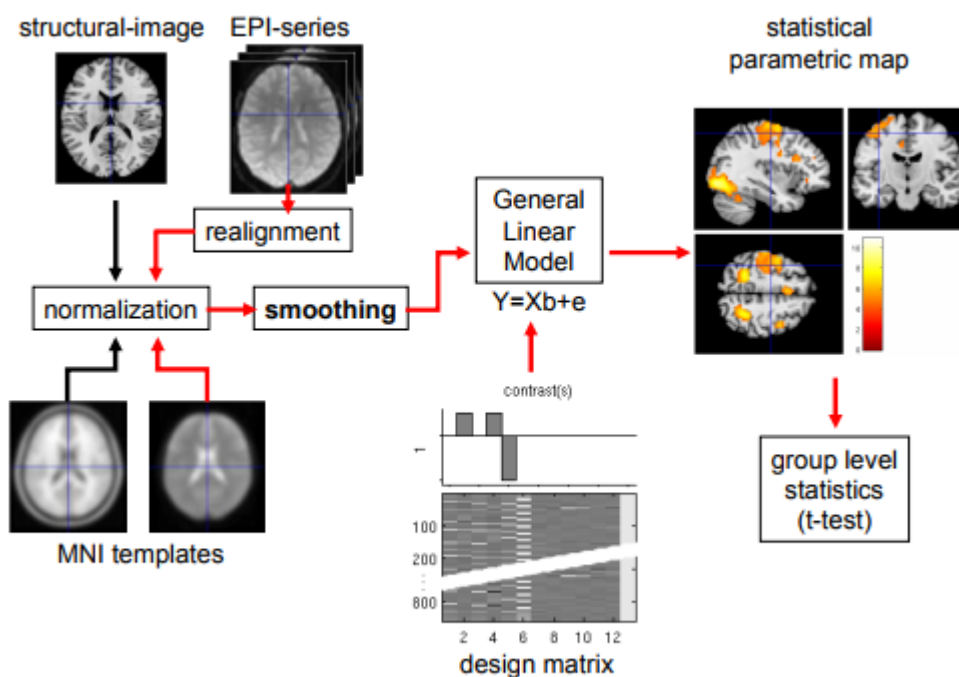

Figure 6.4. Stages of image processing: Preprocessing and statistical analyses of the functional MRI data. fMRI images were realigned to correct for head motion, normalised to the Montreal Neurological Institute (MNI) template brain, smoothed. These realigned smoothed images were then entered into a first level general linear model to specify single subject behavioural events. SPM T-contrasts from the single subject analyses were then used to perform group level statistics.

Statistical Analyses

Behavioural data are presented as mean \pm SD. Pain tolerance data were analysed using IBM SPSS Statistics version 20 (IBM Corp., New York, NY, USA). Shapiro-Wilk test indicated that the data were not normally distributed, so Friedman's test was used. Where significant results were found, follow-up Wilcoxon signed-rank with a Bonferroni adjustment was applied to perform pairwise comparisons between conditions (Pre 0° vs Post 0°, Post 15° vs Post 15° and Post Max vs Pre Max) with the significance level set at $p < 0.017$. In addition, Cohen's d was used to evaluate the magnitude of the effect with $0.2 \leq |d| < 0.5$, small effect; $0.5 \leq |d| < 0.8$, moderate effect; and $0.8 \leq |d|$, large effect.

Results

fMRI Data

Main Effects Analysis

Across the whole brain, the voxel-wise independent samples t-test revealed significant main effects of condition (FWE corrected $p < .05$). These activations are shown in table 6.2-6.7 and Figure 6.5.

Significant activation in the primary somatosensory cortex (BA 3) was found at Pre 0° condition ($p = 0.003$), basal ganglia (putamen) ($p = 0$), pars triangularis (BA 45) ($p = 0.026$), cingulate region of cerebral cortex (BA 32) ($p = 0.01$) at Pre15° condition, and cingulate region of the cerebral cortex (BA 31) and temporal cortex (BA 21) at Post Max condition.

Comparisons between conditions

A voxel-wise repeated measures t-test was conducted in order to determine whether regions between the 6 conditions were statistically different by direct contrast.

The data from the Pre 15° > Pre 0° contrast did not show any significant change. The data from the Pre Max > Pre 0° contrast showed significantly larger activation in frontal cortex includes frontal eye fields (BA 8) ($p = 0.009$) (Table 6.8 and Figure 6.6).

The data from the Post 15° > Post 0° contrast revealed significantly higher activations in temporal cortex (BA 21) ($p = 0.042$) and significantly greater activation in supramarginal gyrus (BA 40) in the Post Max > Post 0° contrast (Table 6.9 and Figure 6.6).

The data from the Post 15° > Pre 15° angle generated no statistically significant activation in BAs. The data from the Post Max > Pre Max contrast there was greater activation in premotor cortex (BA 6) ($p = 0.004$) (Table 6.10 and Figure 6.7).

Realignment parameters for all participants revealed that 9 out of 11 participants had head translations higher than 2mm which is less than desirable. Moreover, the head movement of these participants was mostly associated with the

stretch condition. The consequences of such head movement during scanning will be discussed. Figure 6.8 shows realignment parameters for each participant.

Pain Tolerance

There was a significant interaction (time x angle) effect for the VAS, $\chi^2(5) = 44.397$, $p = 0.00$. Post hoc analyses revealed no significant interaction between all conditions pre to post; (Pre 0° vs Post 0° : $z = -1.841$, $p = 0.066$, $d = -0.56$, Post 15° vs Post 15° : $z = -1.382$, $p = 0.167$, $d = -0.42$ and Post Max vs Pre Max: $z = -1.876$, $p = 0.061$, $d = -0.57$. See table 6.1 below.

Table 6.1. Mean associated with the VAS at pre-and post-intervention at the three ankle angles. Data are mean \pm SD.

		Angles		
		0°	15°	Max
Time	Pre	0 ± 0	2 ± 2	4 ± 2
	Post	1 ± 2	1 ± 1	5 ± 2

Table 6.2. Loci of Activation for the condition Main Effects for Pre 0°. Data were thresholded at a Family-Wise Error-Corrected Threshold of $p < .001$ and cluster correction.

Condition	Lobes	Labels	BA	Cluster p(FWE- corr)	cluster equivk	peak p(FWE- corr)	peak T	peak equivZ	x	y	z
Pre 0°	Parietal Lobe	Postcentral Gyrus	3	0.003	87	0.864	6.13	3.87	-39	-22	47
	Frontal Lobe	Middle Frontal Gyrus	-	0.005	80	0.976	5.41	3.62	33	-10	50

Table 6.3 Loci of Activation for the condition Main Effects for Pre15°. Data were thresholded at a Family-Wise Error-Corrected Threshold of $p < .001$ and cluster correction.

Condition	Lobes	Labels	BA	Cluster p(FWE- corr)	cluster equivk	peak p(FWE- corr)	peak T	peak equivZ	x	y	z
Pre 15°	Frontal Lobe	Precentral Gyrus	-	0	1271	0.048	9.85	4.77	30	-31	56
	Parietal Lobe	Inferior Parietal Lobule	-	0.004	65	0.389	7.79	4.33	51	-43	50
	Sub-lobar	Extra-Nuclear	-	0.024	46	0.473	7.61	4.29	21	23	5
	Sub-lobar	Lentiform Nucleus	Putamen	0	113	0.806	6.69	4.03	21	-10	5
	Frontal Lobe	Inferior Frontal Gyrus	45	0.026	45	0.869	6.42	3.96	-51	38	5
	Parietal Lobe	Sub-Gyral	-	0.022	47	0.879	6.38	3.94	24	-46	44
	Limbic Lobe	Anterior Cingulate	32	0.01	55	0.906	6.24	3.9	-18	35	20

Table 6.4 Loci of Activation for the condition Main Effects for Pre Max. Data were thresholded at a Family-Wise Error-Corrected Threshold of $p < .001$ and cluster correction.

Condition	Lobes	Labels	BA	Cluster p(FWE- corr)	cluster equivk	peak p(FWE- corr)	peak T	peak equivZ	x	y	z
Pre Max	Limbic Lobe	Posterior Cingulate	30	0.796	10	0.953	5.79	3.75	3	-67	8
	Occipital Lobe	Cuneus	-	0.985	4	0.973	5.6	3.69	-27	-88	26
	-	-	-	0.994	3	0.988	5.37	3.6	12	-34	-13
	Temporal Lobe	Sub-Gyral	-	0.994	3	0.999	4.84	3.4	0	-31	-31
	Pons	-	-	0.998	2	0.999	4.82	3.39	-36	-70	-7
	-	-	-	0.947	6	0.999	4.77	3.37	12	-7	-16
	Cerebellum Anterior Lobe	Culmen	-	1	1	1	4.75	3.36	-27	-34	-28
	Limbic Lobe	Parahippocampa Gyrus	-	0.998	2	1	4.67	3.33	18	-19	-22
	Sub-lobar	Extra-Nuclear	-	1	1	1	4.47	3.24	24	-19	-4
	Occipital Lobe	Cuneus	18	0.994	3	1	4.4	3.21	-3	-91	8
	Occipital Lobe	Cuneus	-	1	1	1	4.25	3.14	-21	-70	5
	Midbrain	-	-	0.998	2	1	4.24	3.13	-6	-13	-4

Table 6.5. Loci of Activation for the condition Main Effects for Post 0°. Data were thresholded at a Family-Wise Error-Corrected Threshold of $p < .001$ and cluster correction.

Condition	Lobes	Labels	BA	Cluster p(FWE- corr)	cluster equivk	peak p(FWE- corr)	peak T	peak equivZ	x	y	z
Post 0°	Sub-lobar	Lateral Ventricle	-	1	1	0.825	6.47	3.97	6	20	2
	Temporal Lobe	Sub-Gyral	-	0.999	2	0.989	5.37	3.6	27	-55	2
	Cerebellum Anterior Lobe	Culmen	-	0.999	2	0.99	5.35	3.6	-45	-46	-31
	Occipital Lobe	Cuneus	-	0.697	12	0.991	5.31	3.58	-21	-85	11
	Frontal Lobe	Inferior Frontal Gyrus	-	1	1	0.994	5.22	3.55	36	26	-16
	Sub-lobar	Lateral Ventricle	-	0.985	4	0.996	5.14	3.52	-9	17	11
	Frontal Lobe	Precentral Gyrus	6	0.999	2	0.996	5.14	3.52	42	-19	65
	Frontal Lobe	Precentral Gyrus	-	0.917	7	0.999	4.95	3.44	30	-16	65
	Occipital Lobe	Middle Occipital Gyrus	-	1	1	0.999	4.88	3.41	30	-76	11
	Frontal Lobe	Middle Occipital Gyrus	-	1	1	1	4.58	3.29	54	23	29
	Parietal Lobe	Postcentral Gyrus	-	0.999	2	1	4.56	3.28	-36	-28	41
	Parietal Lobe	Supramarginal Gyrus	-	0.999	2	1	4.55	3.27	-57	-49	29
	Occipital Lobe	Cuneus	18	1	1	1	4.46	3.23	-12	-88	14
	Parietal Lobe	Superior Parietal Lobule	7	1	1	1	4.43	3.22	-33	-52	53
	Parietal Lobe	Inferior Parietal Lobule	40	1	1	1	4.36	3.19	-42	-58	47
	Parietal Lobe	Postcentral Gyrus	3	1	1	1	4.21	3.12	-48	-22	44
	Parietal Lobe	Precuneus	-	1	1	1	4.2	3.12	-21	-73	50
	Sub-lobar	Extra-Nuclear	-	1	1	1	4.15	3.09	21	-34	5
	Frontal Lobe	Middle Frontal Gyrus	-	1	1	1	4.15	3.09	-27	38	-13

Table 6.6. Loci of Activation for the condition Main Effects for Post 15°. Data were thresholded at a Family-Wise Error-Corrected Threshold of $p < .001$ and cluster correction.

Condition	Lobes	Labels	BA	Cluster p(FWE- corr)	cluster equivk	peak p(FWE- corr)	peak T	peak equivZ	x	y	z
Post 15°	Frontal Lobe	Precentral Gyrus	-	0.999	2	0.236	8.24	4.44	-30	-19	59
	Temporal Lobe	Superior Temporal Gyrus	-	0.741	10	0.74	7.08	4.15	-48	17	-19
	Midbrain	-	Medial Geniculum Body	1	1	0.854	6.64	4.02	15	-25	-4
	Limbic Lobe	Parahippocampa Gyrus	Amygdala	0.969	5	0.922	6.3	3.92	-18	-4	-19
	Frontal Lobe	Middle Frontal Gyrus	10	0.741	10	0.977	5.83	3.76	27	50	23
	Sub-lobar	Insula	-	0.987	4	0.991	5.59	3.68	-36	-4	-7
	Frontal Lobe	Sub-Gyral	-	0.147	25	0.992	5.54	3.67	15	-1	59
	Frontal Lobe	Superior Frontal Gyrus	6	0.996	3	0.992	5.54	3.66	-18	-1	71
	Frontal Lobe	Medial Frontal Gyrus	-	0.969	5	0.993	5.53	3.66	12	41	32
	Frontal Lobe	Middle Frontal Gyrus	6	0.996	3	0.997	5.34	3.59	-24	8	65
	Frontal Lobe	Precentral Gyrus	6	0.969	5	0.997	5.32	3.59	33	-10	62
	Sub-lobar	-	Amygdala	0.987	4	0.997	5.31	3.58	24	-10	-10
	Limbic Lobe	Uncus	28	0.987	4	0.997	5.31	3.58	27	5	-22
	Frontal Lobe	Sub-Gyral	-	0.996	3	0.998	5.23	3.55	-30	23	-10
	-	-	-	0.51	14	0.999	5.16	3.52	21	-13	74
	Limbic Lobe	Parahippocampa Gyrus	-	1	1	0.999	5.15	3.52	24	-40	2
	Frontal Lobe	Precentral Gyrus	6	1	1	1	5	3.46	-30	-25	71
	Cerebellum Posterior Lobe	Declive	-	0.999	2	1	4.93	3.43	42	-70	-22
	Frontal Lobe	Precentral Gyrus	6	0.996	3	1	4.87	3.41	42	-19	62
	Parietal Lobe	Precuneus	7	0.999	2	1	4.85	3.4	-24	-73	47

Condition	Lobes	Labels	BA	Cluster p(FWE- corr)	cluster equivk	peak p(FWE- corr)	peak T	peak equivZ	x	y	z
	Frontal Lobe	Middle Frontal Gyrus	-	0.996	3	1	4.82	3.39	-27	2	53
	Frontal Lobe	Precentral Gyrus	6	1	1	1	4.6	3.3	-45	-7	32
	Frontal Lobe	Precentral Gyrus	-	0.996	3	1	4.6	3.3	-51	-13	38
	-	-	-	1	1	1	4.59	3.29	-3	56	32
	Limbic Lobe	Uncus	28	0.987	4	1	4.57	3.28	-27	5	-22
	Frontal Lobe	Precentral Gyrus	-	0.969	5	1	4.54	3.27	-51	-13	29
	Frontal Lobe	Sub-Gyral	-	0.996	3	1	4.53	3.27	-30	44	11
	Frontal Lobe	Superior Frontal Gyrus	-	0.996	3	1	4.47	3.24	15	-7	71
	Parietal Lobe	Superior Parietal Lobule	-	1	1	1	4.45	3.23	-21	-52	62
	Frontal Lobe	Superior Frontal Gyrus	-	1	1	1	4.39	3.21	15	56	29
	Frontal Lobe	Medial Frontal Gyrus	-	1	1	1	4.35	3.18	12	2	53
	Temporal Lobe	Precentral Gyrus	-	1	1	1	4.33	3.18	66	-7	14
	Frontal Lobe	Precentral Gyrus	4	0.999	2	1	4.27	3.15	45	-19	47
	Frontal Lobe	Precentral Gyrus	6	1	1	1	4.26	3.14	57	5	-13
	Frontal Lobe	Sub-Gyral	-	1	1	1	4.24	3.13	36	26	14
	Frontal Lobe	Medial Frontal Gyrus	6	0.999	2	1	4.23	3.13	-12	2	68
	Sub-lobar	Extra-Nuclear	-	1	1	1	4.22	3.13	21	-1	-19
	Frontal Lobe	Sub-Gyral	-	1	1	1	4.22	3.13	-18	35	-13
	Frontal Lobe	Middle Frontal Gyrus	6	1	1	1	4.19	3.11	27	8	68
	Sub-lobar	Extra-Nuclear	0	1	1	1	4.19	3.11	-18	2	23
	Parietal Lobe	Inferior Parietal Lobule	40	1	1	1	4.19	3.11	60	-43	44
	Parietal Lobe	Angular Gyrus	-	1	1	1	4.17	3.1	45	-70	32

Table 6.7. Loci of Activation for the condition Main Effects for Post Max. Data were thresholded at a Family-Wise Error-Corrected Threshold of $p < .001$ and cluster correction.

Condition	Lobes	Labels	BA	Cluster p(FWE- corr)	cluster equivk	peak p(FWE- corr)	peak T	peak equivZ	x	y	z
Post Max	Occipital Lobe	Precuneus	31	0.011	49	0.033	10.25	4.85	15	-64	26
	Temporal Lobe	Inferior Temporal Gyrus	21	0	92	0.363	7.85	4.35	60	-4	-22
	Sub-lobar	White Matter	-	0	104	0.479	7.6	4.28	33	-4	-1

Table 6.8. Loci of Activation for comparisons between the pre-conditions contrasts, determined at a Family-Wise Error-Corrected Display Threshold $p < .001$ and cluster correction.

Conditions	Lobes	Labels	BA	cluster p(FWE-corr)	cluster equivk	peak p(FWE- corr)	peak T	peak equivZ	x	y	z
Pre 15° > vs Pre 0°	Occipital Lobe	Cuneus	-	0	21532	0	1.79E+16	Inf	21	-85	5
	Temporal Lobe	Superior Temporal Gyrus	-	0.023	27	0	1.4E+16	Inf	-66	-19	5
Pre Max vs Pre 0°	Limbic Lobe	Cingulate Gyrus	-	0	22454	0	1.82E+16	Inf	-21	-25	41
	Parietal Lobe	Postcentral Gyrus	-	0.003	38	0	1.37E+16	Inf	-63	-28	41
	Frontal Lobe	Gray Matter	8	0.009	31	0	1.27E+16	Inf	-54	5	44

Table 6.9. Loci of Activation for comparisons between the post-conditions contrasts, determined at a Family-Wise Error-Corrected Display Threshold $p < .001$ and cluster correction.

Conditions	Lobes	Labels	BA	cluster p(FWE-corr)	Cluster equivk	peak p(FWE- corr)	peak T	Peak equivZ	x	y	z
Post 15 > Post 0°	-	Uvula	-	NaN	48586	0	1.78E+16	Inf	-27	-70	-34
	-	-	-	0.007	33	0	1.5E+16	Inf	30	53	-43
	Temporal Lobe	Middle Temporal Gyrus	21	0.042	23	0	1.31E+16	Inf	39	-4	-40
Post Max > Post 0°	Parietal Lobe	Inferior Parietal Lobule	40	NaN	55860	0	1.82E+16	Inf	57	-46	47
	Cerebellum Posterior Lobe	Cerebellar Tonsil	-	0.049	31	0	1.5E+16	Inf	-15	-37	-49

Table 6.10 Loci of Activation for comparisons between the pre-and post-conditions contrasts, Determined at a Family-Wise Error-Corrected Display Threshold $p < .001$ and cluster correction.

Conditions	Lobes	Labels	BA	cluster p(FWE- corr)	cluster equivk	peak p(FWE- corr)	peak T	peak equivZ	x	y	z
Post 15° > Pre15°	Frontal Lobe	Inferior Frontal Gyrus	-	0	22520	0	1.83E+16	Inf	-45	35	2
	-	-	-	0.018	28	0	1.31E+16	Inf	-18	-37	80
Post Max > Pre Max	Limbic Lobe	Uncus	-	0	0	0	Inf	0	-27	5	-34
	Parietal Lobe	Precentral Gyrus	-	0	0	0	Inf	0	-66	-10	23
	-	-	-	0	0	0	Inf	0	27	-55	68
	Frontal Lobe	Middle Frontal Gyrus	-	0.004	0	0	Inf	0	-33	32	50
	Frontal Lobe	Precentral Gyrus	6	0	0	0	Inf	0	-60	-10	41
	-	-	-	0	0	0	Inf	0	48	-25	65
	Cerebellum Posterior Lobe	Tuber	-	0	0	0	Inf	0	51	-70	-34
	Frontal Lobe	Precentral Gyrus	6	0.004	0	0	Inf	0	12	-22	77
	Frontal Lobe	Medial Frontal Gyrus	-	0	0	0	Inf	0	-9	59	-10
	-	-	-	0.008	0.001	0	Inf	0	-18	-34	83
	-	-	-	0.009	0.001	0	Inf	0	36	59	-43
	Frontal Lobe	-	-	0.001	0	0	Inf	0	-45	-19	65
	Parietal Lobe	Sub-Gyral	-	0.008	0.001	0	Inf	0	33	-58	29
	Frontal Lobe	-	-	0.008	0.001	0	Inf	0	18	65	26

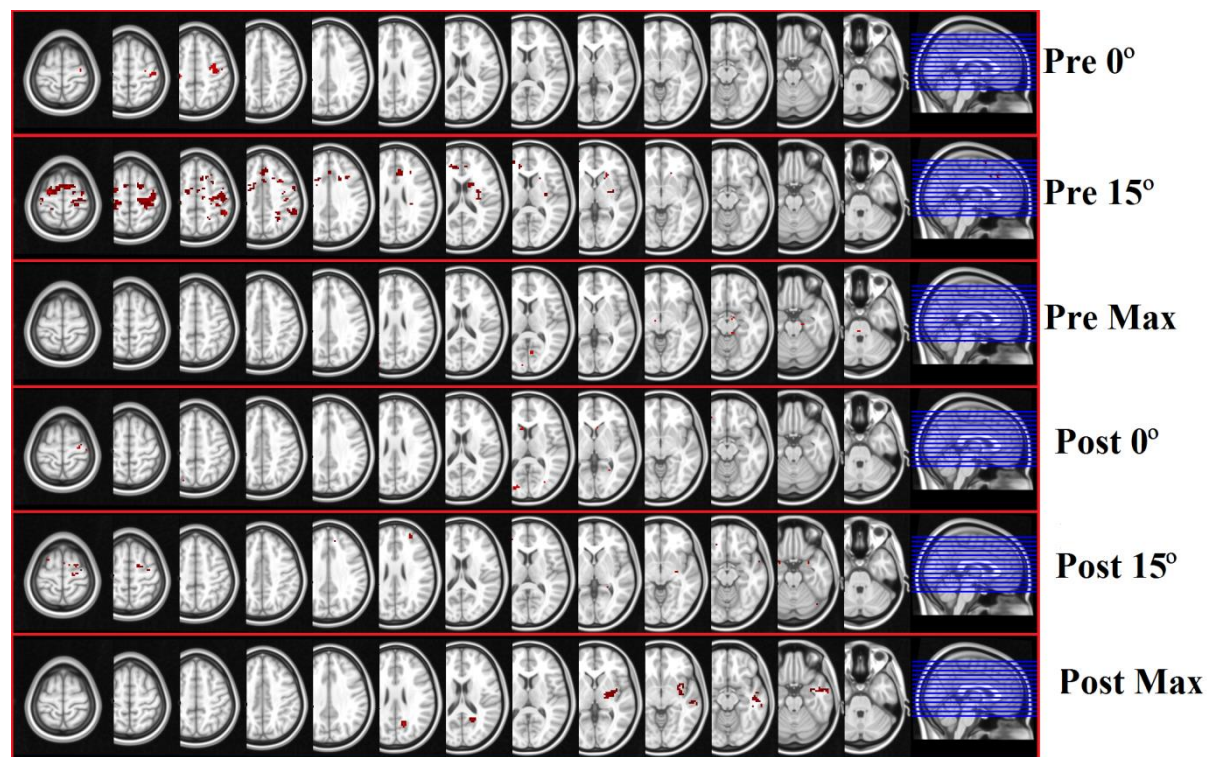

Figure 6.5. Thresholded signal increases (red) of the group main effect contrasts for Pre 0°, Pre 15°, Pre Max, Post 0°, Post 15°, Post Max. All maps thresholded at $p < 0.001$; 0.05 FWE-corrected critical cluster size was 80 for Pre 0°, 45 for Pre 15° and 49 for Post Max. Overlays were created using MRIcron software (www.mccauslandcenter.sc.edu/crnl/mricron/).

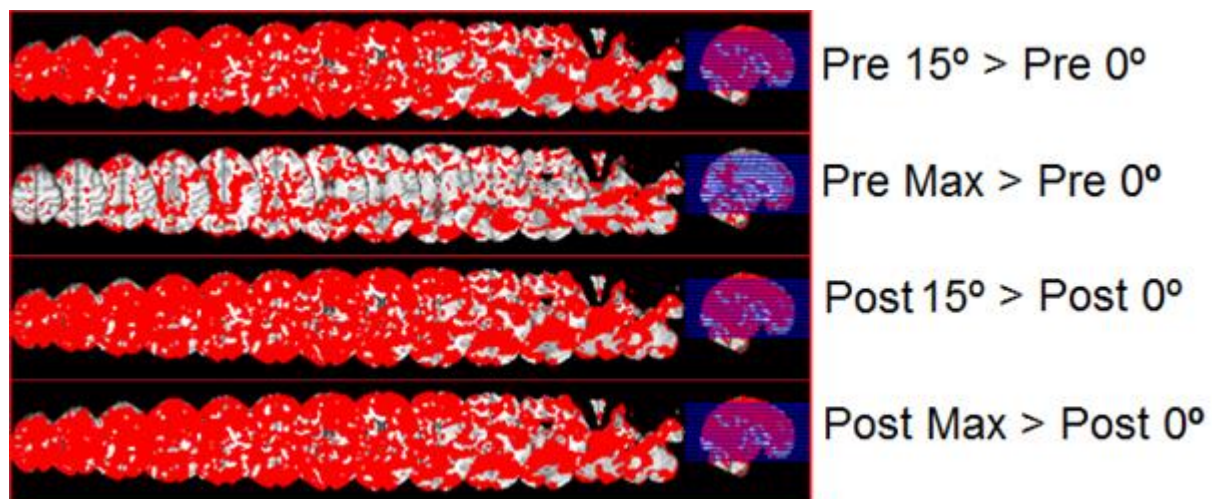

Figure 6.6. Thresholded signal increases (red) of the between pre-and between post condition contrasts for Pre 15° > Pre 0°, Pre Max > Pre 0°, Pre 15° > Pre 0° and Post Max > Post 0°. All maps thresholded at $p < 0.001$; 0.05 FWE-corrected critical cluster size was 27 for Pre 15° > Pre 0°, 31 for Pre Max > Pre 0°. Overlays were created using MRIcron software (www.mccauslandcenter.sc.edu/cnrl/mricron/).

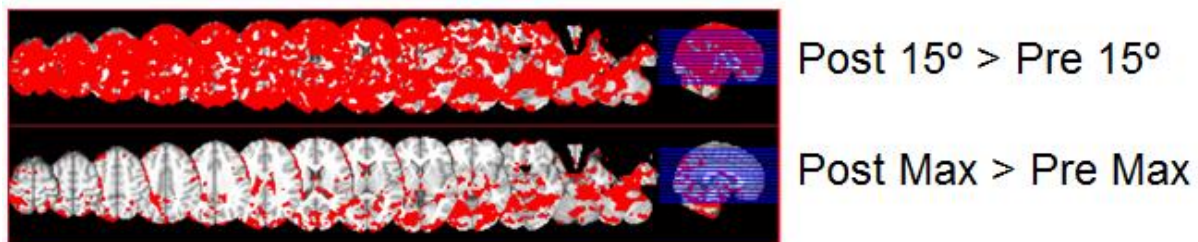
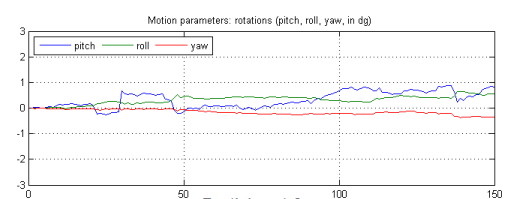
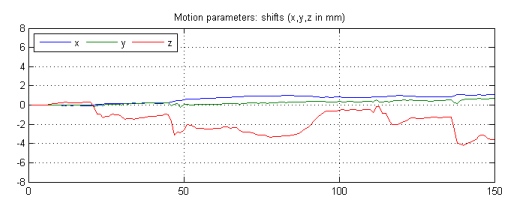
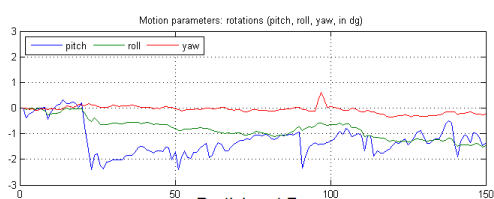
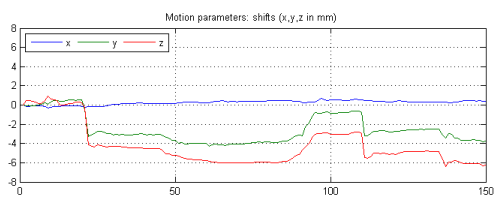
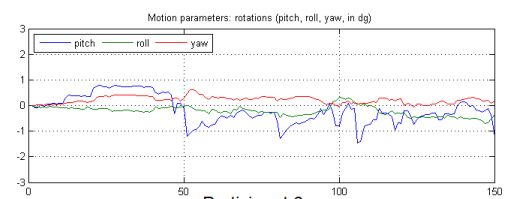
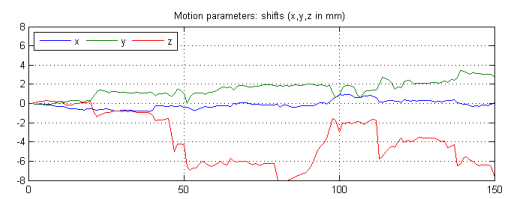
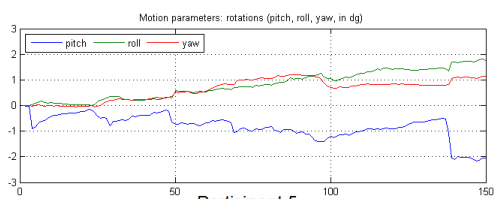
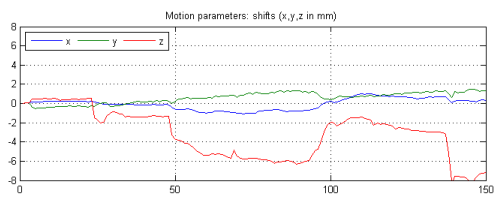
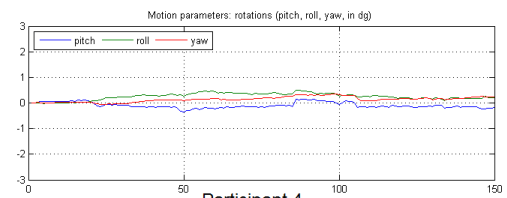
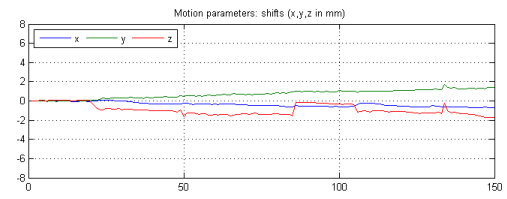
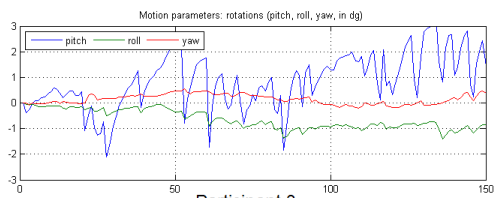
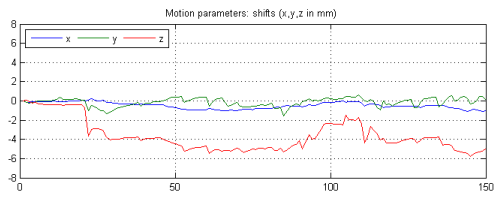
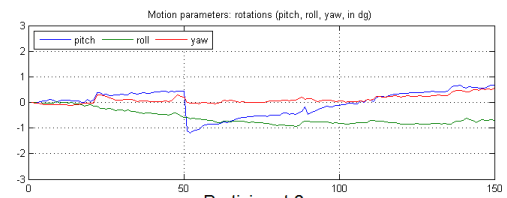
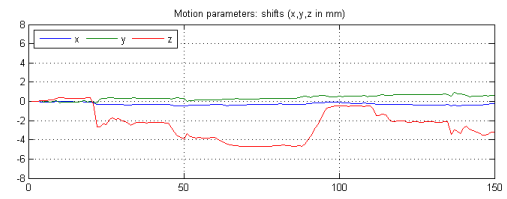
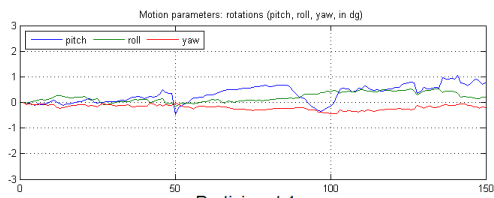
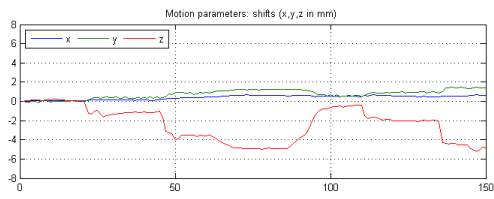

Figure 6.7. Thresholded signal increases (red) of the between pre-and post-condition contrasts for Post 15° > Pre 15° and Post Max > Pre Max. All maps thresholded at $p < 0.001$; FWE-corrected critical cluster size was 28 for Post 15° > Pre 15° and 35 for Post Max > Pre Max. Overlays were created using MRIcron software (www.mccauslandcenter.sc.edu/crnl/mricron/).



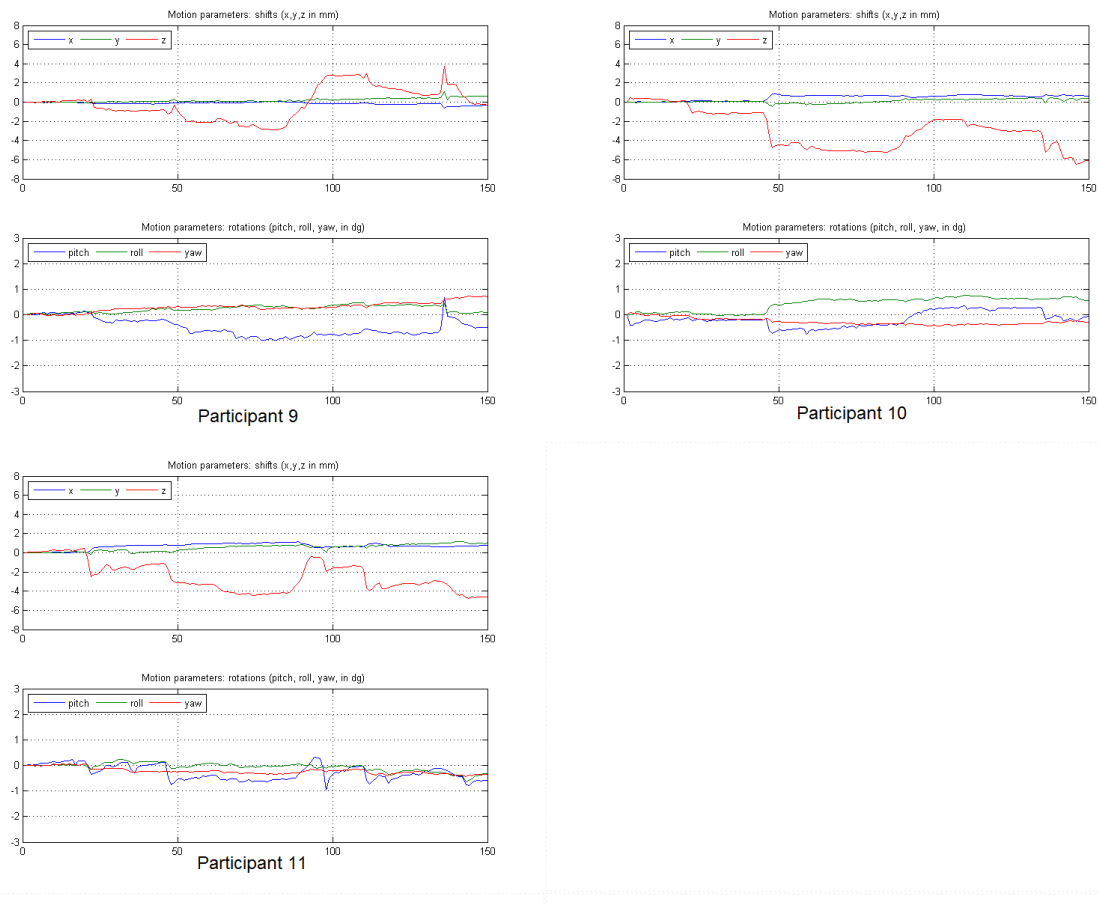

Figure 6.8. Realignment parameters for participants 1-11. Three translation parameters which code movement in the directions of the three-dimensional axes, movement along the X, Y, or Z axes; and three rotation parameters which code rotation about those axes, rotation centred on each of the X, Y, and Z axes).

Discussion

The present study aimed to investigate the effect of static stretching upon the ankle plantarflexor muscles and its associated change in brain activations. The primary hypothesis was that structures typically associated with motor execution are likely to show the largest change due to stretching. A secondary hypothesis was that brain activity both during and following stretching would result in changes in activation for brain regions typically involved in the processing of pain and perception, such as the insular cortex, the amygdala, periaqueductal grey (PAG), dorsolateral pontine tegmentum (DLPT) and rostroventral medulla (RVM) in the brain stem.

The whole brain main effects analysis for each of the stretch conditions did not show convincing significant behavioural activations for all conditions. Pre 0° showed significant activation in the primary somatosensory cortex (BA 3) and Pre 15° showed significant activation in basal ganglia (putamen), pars triangularis (BA 45), cingulate region of cerebral cortex (BA 32). Significant main effect activation was observed in the cingulate region of the cerebral cortex (BA 31) and temporal cortex (BA 21) for Post Max only.

These activation patterns were in line with previous evidence on the functional neuroanatomical correlates of passive movement (Ciccarelli et al., 2005; Guzzetta et al., 2007) and the assumption that the efferent feedback produced by passive movement during the stretching not only targets somatosensory but also motor areas (Ciccarelli et al., 2005) and also activation of areas of pain perception (Apkarian et al., 2005).

Beyond the main behavioural effects, the between-condition fMRI comparisons revealed an extremely large extent of relative difference in cortical activations. For all between condition comparisons (Pre 15° > Pre 0°, Pre Max > Pre 0°, Pre 15° > Post 0° and Post Max > Post 0°) the range and extent of significant differences were pervasive across the whole brain in multiple brain regions. Such an amount of significant difference is unfortunately not a sensible answer and highlights a number of potential problems in the current experimental design.

Unfortunately, if this experiment is considered only as a behavioural experiment – the behavioural results for pain perception as rated using the visual analogue scale (VAS) scale also showed no significant difference between stretch

conditions. One possibility is that the manual stretching of the ankle plantarflexors was not sufficient to cause a sufficient increase in pain perception as well as a significant increase in joint ROM post stretching. However, measurement of joint ROM was not recorded. Since VAS score has high variability in addition to the participants perception of stretching determined by the degree of tissues extensibility (i.e. joint angle) and not by the tissue's tension (i.e. joint passive torque) (Freitas et al., 2015) a measure of joint angle pre and post stretching would have indicated if our stretching protocol was effective.

After troubleshooting the analyses, inspection of the realignment parameters for the fMRI data revealed that the problem is likely due to the noise/movement artefacts in our time series. Despite taking every caution to minimise participant head movement by strapping the legs and using a head supporting cushions, the realignment parameters showed that the actual head movement for most participants was more than 2 mm in the z-direction (9 out of 11 participants: refer to Figure 6.8). Moreover, these head movements were very much associated with the behavioural element of the fMRI experiment (i.e. the stretch routine). Such an association between head movements and behaviour is a very undesirable factor to have in fMRI because they can induce substantial spin-history and slice-readout artefacts, and cause geometric deformation of the brain (Friston, Williams, Howard, Frackowiak, & Turner, 1996; Hajnal et al., 1994). At the beginning of the scan session voxel x could be in another location than at the end of the experiment. Moreover, motion can lead to edge artefacts that will show up as intense activations at the end of the brain or near the ventricles. The brain tissue near the edges or ventricles moves into a part of the image that has very low signal strength (the area outside of the brain or the cerebrospinal fluid of the ventricles). This change from brain tissue to outside the brain or the ventricles is very large; it will show up as a large increase in signal (Willems & Cristia, 2017).

Movement artefacts in fMRI degrade image quality and lead to misinterpretation of fMRI data (Havsteen et al., 2017). During visual inspection of the fMRI sequence (Figures 6.6-6.7) motion artefacts were identified causing signal changes that may severely confound statistical analysis rendering results unreliable (Satterthwaite et al., 2012; Van Dijk, Sabuncu, & Buckner, 2012).

Furthermore, the experimental design of a single behavioural stretch, which was used, is also undesirable in fMRI experiments. Typically, the blood-oxygen-level-dependent (BOLD) signal is very small (~1.5% or often less) and as such requires a number of experimental stimuli repetitions in order to achieve a good signal to noise ratio and allow a single robust estimation. Often in fMRI experiments, a small number of participants is used to pilot a study, but larger participant numbers (i.e. 20+) are required to have a statistical analysis that can be considered robust (Desmond & Glover, 2002). In the design used in this experiment, a single event for three separate angles of stretch was used. Due to the associated movement, the low number of event repetitions and low participant number it was unable to successfully find meaningful brain activation signal differences. It is suggested that fMRI studies require repetition (multiple trials) to help obtain statistically significant brain activations (Dimoka, 2012).

The testing procedure/protocol by showing PowerPoint slides and asking the participant to rate the level of pain perception/stretch tolerance have activated BAs involved with visual processing and thinking (BA 17). Additionally, manual rotation of the foot by touching the foot, so activation of the BAs involved with tactile information may have been activated (BAs 1-3).

Another potential limitation of the current study is the lack of electromyographic data collected from the TA, SOL and gastrocnemius muscles during the fMRI protocol. The potential exists that the speed of rotation of the ankle joint might have elicited any reflex mediated muscle activity, thereby affecting the results (Gottlieb & Agarwal, 1979). Furthermore, the duration of the conditions might have led to insufficient behaviours.

Additionally, the results of this study are further confounded by the lack of any behavioural difference pre and post stretching. Such a lack of a behavioural difference makes it even more unlikely that we would be able to observe meaningful, significant differences in brain activation.

Ways that future studies would be able to improve on this study presented here would be to:

1. A protocol should be employed with sufficient trial behaviours, i.e. longer time periods for each condition (larger number of blocks). Ideally in the range of 30-40 repetitions.
-

2. Limit head motion, using a custom-made body fixation and head of each participant making sure the movement artefacts/noise is kept to a minimum (<2 mm). Further, there should be a goal to avoid rapid head movement of 2 mm or more between each scan particularly during any stretch manipulation or participant relaxation after stretching.
3. Use a foot pedal manipulandum where each participant can manually adjust the stretch up to the point of discomfort so that each participant can find his/her individual point of discomfort.
4. A simpler alternating block design with a single behaviour event, i.e. stretching to the point of discomfort for at least a minute followed by a minute of rest for at least 10 repetitions. However, a longer stretching period may cause different mechanisms contributing to the increased ROM such as creep deformation/force relaxation. To counteract these effects, it is suggested that the use of foot manipulandum that will actively move the foot into dorsiflexion and the participants should have a button to manually stop it once it reaches to the point of discomfort. This should be repeated for each repetition.
5. Increase the number of repetitions in order to achieve a good signal to noise ratio and allow a single robust estimation.
6. Recruit a larger number of participants to have a statistical analysis that can be considered robust.
7. To avoid activation in the visual cortex, participants should have been told to keep their eyes closed throughout.

Conclusion

Although this study failed to answer the hypothesis due to a number of inherent difficulties with performing a stretch experiment within an MRI environment, it can be seen as a good basis on which future studies can build. A number of simple changes to the experimental setup and overall experimental design could easily be employed that allow a better understanding of the neuronal changes that underpin an improvement in flexibility.

Chapter 7 General Discussion

The beneficial effect of pre-exercise static stretching on different aspects of performance has recently been questioned. Numerous studies have reported that acute static stretching can induce significant decrements in muscular performance (maximal voluntary strength, muscle power, sprint time and jump height) (Behm et al., 2015). Both mechanical and neural mechanisms have been suggested as possible contributors to the performance deficits (Behm et al., 2001). This has resulted in a shift from static stretching to dynamic stretching and recommendation that dynamic stretching may be included in the stretching component of warm-ups to increase task-specific ROM, and facilitate SSC when a full pre-activity routine is not completed (Behm et al., 2015).

Several studies have shown that there is no stretch-induced strength loss after dynamic stretching (Herda et al., 2008; Hough, Ross, & Howatson, 2009) and that dynamic stretching may improve isometric and isotonic contractions (Manoel et al., 2008; Yamaguchi & Ishii, 2005). Recent evidence also indicates that dynamic stretching could facilitate power production (Manoel et al., 2008; Yamaguchi & Ishii, 2005), and improve sprint time (Little & Williams, 2006) and jump height (Holt & Lambourne, 2008; Hough et al., 2009). Despite the growing number of studies examining the acute effects on muscular performance following dynamic stretching, the mechanisms that explain the potential beneficial effects of dynamic stretching on short-term performance remain largely speculative.

The suggested mechanisms for the effect of dynamic stretching on performance include increased heart rate, elevation of core and muscle temperature (Bishop, 2003b; Fletcher & Jones, 2004; Yamaguchi & Ishii, 2005), and increased transmission rate of nerve impulses and metabolism (Bishop, 2003a). Moreover, specific rehearsal of movement patterns may enhance proprioception (Fletcher & Jones, 2004), and increase neuromuscular activity (Behm & Chaouachi, 2011; Faigenbaum et al., 2005). This is possibly linked to PAP (Yamaguchi & Ishii, 2005), which in turn may lead to performance enhancement. Despite the considerable amount of evidence for improved muscular performance following dynamic stretching, these mechanisms remain essentially theoretical and poorly understood.

One possible effect of the elevated muscle temperature resulting from dynamic stretching is a decrease in its viscosity (Bishop, 2003a; Buchthal, Kaiser, & Knappeis, 1944). Decrease in muscle viscosity can decrease passive torque at end ROM and increase joint ROM (Kubo et al., 2002; Magnusson et al., 1995; Magnusson, Simonsen, Aagaard, & Kjaer, 1996). Thus, one would expect a change in the muscle-tendon unit mechanical properties as a result of dynamic stretching. Herda et al. (2013) used dynamometry to show the effects of dynamic stretching on reducing passive muscle-tendon unit stiffness as a possible mechanism of the increased ROM of the target muscle by measuring the relationship between the joint angle and passive resistive torque during motion. Samukawa et al. (2011), using B-mode ultrasonography, observed an increased proximal displacement of the muscle-tendon unit of the medial head of the gastrocnemius while standing suggesting that this contributed to the observed increased ankle ROM. Nevertheless, this study did not employ the commonly used method of measuring passive mechanical properties of the muscle-tendon unit (i.e. measuring the muscle-tendon unit displacement using ultrasonography from a neutral to a fully stretched position (Kay & Blazevich, 2009; Morse et al., 2008; Nakamura, et al., 2011, 2013)) that has been shown to correlate with the reduction in muscle strength after static stretching (Bouvier, Opplert, Cometti, & Babault, 2017). In contrast, Mizuno and Umemura (2016) reported that dynamic stretching did not alter the mechanical properties of the muscle-tendon unit, attributing the change in ROM to enhanced stretch tolerance. A reason for such inconsistency in the results of the studies above could be the employment of varied dynamic stretching techniques.

Building on the above studies which investigated the effect on muscular performance, the possibility of the existence of a relationship between dynamic stretching and running economy, as a physiological determinant of endurance performance, is not a new concept. In fact, some researchers have already shown that dynamic stretching has no effect on endurance runners (Hayes & Walker, 2007; Yamaguchi, Takizawa, & Shibata, 2015) or increases in energy (caloric) expenditure (Zourdos et al., 2012). In general, running economy appears to be trainable; however, the key factors that result in improved running economy remain elusive. Recently, there is an increased interest in the lower limb stiffness and how this is related to enhanced performance. Since improving strength and power was shown

to improve running economy and performance in previous research, it has been proposed that improvement in running economy may occur through changes in muscle-tendon unit stiffness (Kubo et al., 2006, 2007). Both muscle and tendon properties may be important for the transfer of energy during locomotion. Stored energy in these physiological springs (muscle and tendon) could conceivably reduce muscle activation and spare energy expenditure, thus improving running economy. Overall leg and muscle-tendon unit stiffness may be considered as essential contributors to running economy (Dalleau, Belli, Bourdin, & Lacour, 1998; Lichtwark & Wilson, 2008; Saunders, Pyne, Telford, & Hawley, 2004).

The present research investigated the acute effect of dynamic stretching at two (system and activity) levels. A combination of different techniques such as ultrasonography, dynamometry, motion analysis, elastography, and electromyography were used to monitor the acute effects of dynamic stretching on the passive ankle joint ROM, plantarflexion torque-generating capacity, passive mechanical and sensorimotor properties of the gastrocnemius muscle and tendon, and dynamic and vertical stiffness and running economy. To further probe into the neural mechanisms involved in the altered flexibility after stretching, an attempt to examine whether altered perception of pain (i.e. increased tolerance to the stretching pain) may be a contributing factor to the increased joint ROM. Different samples of participants of both sexes took part in these series of studies.

Effect of Different Dynamic Stretching Velocities on Plantarflexor Muscles Neuromechanical and Sensorimotor Performance

In chapter 3, alterations in the mechanical properties of the muscle-tendon unit, in terms of changes in the muscle and tendon strain as one of the mechanisms contributing to the increased joint ROM after dynamic stretching, were assessed *in vivo*. Both slow dynamic stretching and fast dynamic stretching conditions revealed that the increased ROM was due to the increase in tendon strain. An increase in tendon strain could decrease the fibre length at which the muscle works at a given joint angle. This could compromise plantarflexor torque production by placing the sarcomere at a sub-optimal position on the force-length curve, however, the

decrease in muscle length may have compensated for this suboptimal length since the shorter and stiffer muscle could help to develop higher force due to a slower shortening velocity of the muscle fibre (Kubo et al., 2010). In the present research, ultrasonography and motion analysis were combined with muscle modelling to calculate muscle-tendon unit, muscle and tendon strain at end plantarflexion ROM. The results indicated that the magnitude of increase in tendon strain was one of the contributing factors to the increased passive ROM. Although a change was found in the muscle-tendon unit mechanical properties, our dynamic stretching protocols did not cause any increased strength losses and in some cases augmented strength at neutral ankle position. Results of the sensorimotor performance assessment were mainly unclear. As such, findings from the present study show preservation of the ability, and certainly not a detrimental effect, on the ability to produce force at the appropriate level and on proprioception after dynamic stretching. Hence, dynamic stretching can be recommended (as used in the present study) in warm-up routines.

Effects of an Acute Bout of Dynamic Stretching on Biomechanical Properties of the Gastrocnemius Muscle Determined by Shear Wave Elastography

Single muscle localised properties can be assessed *in vivo* using shear wave elastography, a novel technique in which shear waves are generated in the tissue. The speed of these shear waves is related to material properties, such that shear waves travel faster through stiffer tissues. Shear wave elastography is a direct quantitative and sensitive method that enables the assessment of localised single muscle's mechanical properties. In shear wave elastography, an acoustic radiation force (ARF) push non-invasively generated shear waves in the tissue, while ultrasonic methods are used to measure the shear wave propagation speed. The speed of the propagating shear wave is proportional to the shear modulus of the tissue, which is considered to be synonymous with tissue stiffness. Previous studies evaluated stiffness either by measuring the relation between joint angle and passive torque developed as resistance to joint movement (i.e. torque-joint angle relationship; using a numerical optimisation technique (Hoang et al., 2005; Nordez et al., 2010) or by measuring the muscle-tendon unit displacement from a neutral to a

fully stretched position (Kay & Blazevich, 2009; Morse et al., 2008; Nakamura et al., 2011, 2013) (i.e. force-displacement relationship). Whilst five studies (Akagi & Takahashi, 2013; Freitas et al., 2015; Hirata et al., 2016; Nakamura et al., 2014; Taniguchi et al., 2015) employing shear wave elastography reported decreased shear wave speed in response to static stretching of the plantarflexor muscles, this study showed an increase in muscle stiffness, decrease in fascicle strain and increase in thickness after dynamic stretching, suggesting an increase in tendon compliance as a contributing factor to the increased ankle flexibility.

Influence of Dynamic Stretching on Ankle Joint Stiffness, Vertical Stiffness, and Running Economy during Treadmill Running

The oxygen cost of running influences running performance where an increased (oxygen) energy cost results in rapid fatigue. Inverse dynamics were used to calculate ankle dynamic joint and vertical stiffness and online gas analysis to assess running economy measured as oxygen uptake during a maximum incremental exercise test after an acute dynamic stretching protocol. The results indicated that dynamic stretching improved running economy possibly via decreasing dynamic and joint stiffness which is in agreement with (Herda et al., 2013). However, the present findings were not in agreement with previous studies; which found no change in running economy (Hayes & Walker, 2007; Yamaguchi et al., 2015) or increase in energy (caloric) expenditure (Zourdos et al., 2012) after a dynamic stretching protocol. Additionally, previously reported results on vertical stiffness found no significant difference in vertical stiffness after dynamic stretching (Pappas et al., 2017). The dynamic stretching protocol implemented decreased running economy in a sample of recreationally active runners and may be attributable to reduced muscle activation, decreasing dynamic joint and vertical stiffness.

Neural Correlates of Pain Threshold during Passive Stretching. Is there a Relationship between Pain Tolerance and Increased Range of Motion? – A Pilot Study

In this study using fMRI, the aim was to investigate whether modification of pain tolerance as a potential mechanism for the improved ankle joint ROM after an acute static stretching protocol of 1 min duration. Activation patterns were expected to be found in the somatosensory but also in motor areas (Dechaumont-Palacin et al., 2008) and areas of pain perception (Apkarian et al., 2005). However, due to methodological issues after inspection of the data, it was concluded that the results were not sensible and hence, no conclusions were made.

Limitations

- Due to the frequent inclusion of a warm-up routine by sports/clinical population and considering the application based nature of the present research and the fact that Study 1 protocol included maximal contractions, a 5-min warm-up was included in both studies 1 and 2, to decrease the risk of injury. The inclusion of this warm-up period might have confounded the results of dynamic stretching in the first and second studies (Chapters 3 and 4). However, because a decrease in dynamic joint stiffness was also found in study 3, where dynamic stretching was the warm-up, it can be concluded that the dynamic stretching alone had an impact on the muscle-tendon unit properties.
 - Ankle peak torque was measured isokinetically, similar to some other studies (Arampatzis et al., 2005; Magnusson, Aagaard, Rosager, Dyhre-Poulsen, & Kjaer, 2001; Rosager et al., 2002). However, it is recommended that training studies should be based on performance changes, such as jump heights and not changes in muscle function scores (Murphy & Wilson, 1997). Peak torque values are reliable measures of muscle function, as long as strict experimental parameters are observed in the isokinetic test (Baltzopoulos, 2008). The isokinetic test was designed to stabilise limbs to isolate specific muscle actions and minimise calcaneal movement, but the effect on peak force production in a more
-

ecologically valid performance test, such as a 1 repetition squat test, would be interesting to investigate.

- A limitation of study 1 was the method employed to measure the length of the muscle tendon unit, we used a cadaveric model (Grieve et al., 1978) and a combination of motion analysis (distance between the epicondyle and the calcanei) and dynamometry (ankle ROM) techniques. The muscle and tendon strain was calculated using a combination of ultrasonography and the model proposed by Fukunaga et al. (2001). However, the maximum elongation of the muscle and tendon, as well as the corresponding strain at passive dorsiflexion at end ROM, exceeded the maximum elongation and maximum strain of the muscle and tendon that could be determined during isometric contractions. As such, we modelled muscle and tendon lengths to be straight lines, which would have likely underestimated the muscle and tendon elongation. However, since this method was used for all participants, a systematic error which might have occurred would not change the results and conclusions of the study.
 - The findings of the current studies may apply to recreationally active but not elite athletes. Since highly trained long-distance runners show higher distribution of slow twitch fibres (Costill et al., 1976) which are stiffer than fast twitch fibres (Petit, Filippi, Emonet-Denand, Hunt, & Laporte, 1990; Proske & Rack, 1976), the result cannot be generalised to different groups of athletes.
 - During pilot testing due to laboratory restriction, it was found out that only situ stretches could be reproduced at the required set velocity/rate reliably. Participants found it difficult to coordinate the dynamic stretch movement at the set rate through the designated active ROM while moving but found it easy to keep the metronome pace when stationary, although it was found that stationary stretches have less effect on performance (Fletcher & Anness, 2007; Fletcher & Jones, 2004).
 - Not a direct measure of muscle activity (i.e. EMG) throughout the passive dorsiflexion and plantarflexor movement was made to ensure that the muscles remained passive in study 2. However, the fact that the participants were instructed to stay relaxed throughout the testing procedures, and that we monitored fascicle length using B-mode ultrasonography and made sure that it
-

stayed constant at the end ROM of passive ankle movements indicate that the muscle was quiet during the shear wave speed passive measurements.

- A lower body model was used for study 3 instead of a full body one as it is a common practice to collect data from only the pelvis and the lower limbs during running (Franz, Paylo, Dicharry, Riley, & Kerrigan, 2009; L. Smith, Preece, Mason, & Bramah, 2015). One might question that although the arms act to counteract the angular momentum by the lower limbs about the vertical axis (Hamner, Seth, & Delp, 2010), the contribution of the arms and head to linear COM motion, in each plane is not clear. However, recently it has been shown that a full body model is not required if COM motion is to be measured in the anterior-posterior or vertical directions (Gill, Preece, Young, & Bramah, 2017) as in the case of calculating vertical stiffness.

Conclusion

Several significant findings have been reported in this thesis and provide a better understanding how neuromechanical adaptations and knowledge of muscle-tendon mechanics can be implemented in athletic practice. The results showed that the properties of the muscle-tendon unit can be manipulated by dynamic stretching. The associated changes in the passive ROM (flexibility) were attributed to the increased strain in the tendon, although we cannot refute that increased pain tolerance might have an additional effect. The findings also revealed that dynamic stretching does not compromise strength performance when assessed by isokinetic dynamometry. Results for proprioception should be treated with caution. The findings also showed that muscle stiffness assessed using shear wave elastography was increased with dynamic stretching contributing to the decrease in muscle strain and increased tendon strain. The effects of dynamic stretching on a subsequent endurance test suggested that the improved running economy might be attributable to decreased dynamical joint stiffness, vertical stiffness and motor unit activation.

Practical Implications

Based on the findings of this series of studies, one could suggest the following recommendations, to athletes and coaches who wish to employ dynamic stretching as part of a warm-up strategy, to maximise acute performance:

- Dynamic stretching can increase ROM via increasing tendon strain.
- Dynamic stretching may not compromise strength performance.
- Dynamic stretching may increase running economy assessed by decreasing $\dot{V}O_2$ via decreasing joint stiffness, vertical stiffness and motor unit activation.

Directions for Future Research

The current thesis investigated some of the mechanisms through which dynamic stretching may affect flexibility and performance. Future research may explore other mechanisms which may contribute to the effects of dynamic stretching on the mechanical properties of the muscle-tendon unit and different aspects of performance:

- Muscle temperature – this could be done *in vivo* with a muscle temperature probe used to ascertain increases in internal muscle temperature. This will help answer the question whether increased temperature of the muscle fibre during contraction through ATP turnover or stimulating the nervous system can increase shortening velocity.
 - Dynamic strain rate could be assessed for its effect on strength performance.
 - Assessment of strength during the concentric/eccentric/isometric contractions at different angles/length to assess whether dynamic stretching affects the force-length and force-velocity relationship.
 - The rate of force development, time to peak force and electromechanical delay can be assessed both volitionally and by electrical stimulation as measures of performance. It is interesting to examine if any of these variables can be enhanced by dynamic stretching.
 - It would be interesting to see how dynamic stretching affects other dynamic activities such as sprint running or jumping that include faster SSCs.
-

-
- Post-activation potentiation – Two primary mechanisms are put forward to explain whether PAP affects performance. Phosphorylation of myosin regulatory light chains making actin and myosin more sensitive to the intracellular Ca^{2+} signal, increasing cross-bridge formation for the same Ca^{2+} concentration (Batista et al., 2007; Chiu et al., 2003; Comyns, Harrison, Hennessy, & Jensen, 2006), and/or neuromuscular excitation by increasing activation of α motoneurons (Esformes, Cameron, & Bampouras, 2010; Güllich & Sehmtdbleicher, 1996; Trimble & Harp, 1998; Tubman, MacIntosh, & Maki, 1996). Post-activation potentiation can be measured by either muscle twitch response (twitch potentiation) and H-reflex (reflex potentiation) (Grange, Cory, Vandenboom, & Houston, 1995; Güllich & Sehmtdbleicher, 1996; Sweeney, Bowman, & Stull, 1993; Trimble & Harp, 1998).
-

Chapter 8 References

- Aagaard, P., Andersen, J., Dyhre-Poulsen, P., Leffers, A., Wagner, A., Magnusson, S., ... Simonsen, E. (2001). A mechanism for increased contractile strength of human pennate muscle in response to strength training: Changes in muscle architecture. *The Journal of Physiology*, *534*(2), 613–623.
<https://doi.org/10.1111/j.1469-7793.2001.t01-1-00613.x>
- Aagaard, P., Simonsen, E., Andersen, J., Magnusson, S., & Dyhre-Poulsen, P. (2002). Neural adaptation to resistance training: changes in evoked V-wave and H-reflex responses. *Journal of Applied Physiology*, *92*(6), 2309–2318.
<https://doi.org/10.1152/japplphysiol.01185.2001>
- Abbate, F., Sargeant, A., Verdijk, P., & de Haan, A. (2000). Effects of high-frequency initial pulses and posttetanic potentiation on power output of skeletal muscle. *Journal of Applied Physiology*, *88*(1), 35–40. Retrieved from
<http://jap.physiology.org/content/88/1/35>
- Abe, T., Fukashiro, S., Harada, Y., & Kawamoto, K. (2001). Relationship between sprint performance and muscle fascicle length in female sprinters. *Journal of Physiological Anthropology and Applied Human Science*, *20*(2), 141–147.
<https://doi.org/10.2114/jpa.20.141>
- Abe, T., Kumagai, K., & Brechue, W. (2000). Fascicle length of leg muscles is greater in sprinters than distance runners. *Medicine and Science in Sports and Exercise*, *32*(6), 1125–1129. <https://doi.org/10.1097/00005768-200006000-00014>
- Abe, D., Muraki, S., Yanagawa, K., Fukuoka, Y., & Niihata, S. (2007). Changes in EMG characteristics and metabolic energy cost during 90-min prolonged running. *Gait and Posture*, *26*(4), 607–610.
<https://doi.org/10.1016/j.gaitpost.2006.12.014>
- Agre, J. (1985). Hamstring injuries: proposed aetiological factors, prevention, and treatment. *Sports Medicine*. Springer International Publishing.
<https://doi.org/10.2165/00007256-198502010-00003>
-

- Agten, C., Dyer, L., Flück, M., Pfirrmann, C., & Roskopf, A. (2017). Delayed-onset muscle soreness: Temporal assessment with quantitative MRI and shear-wave ultrasound elastography. *American Journal of Roentgenology*, *208*(2), 402–412. <https://doi.org/10.2214/AJR.16.16617>
- Aguilar, A., DiStefano, L., Brown, C., Herman, D., Guskiewicz, K., & Padua, D. (2012). A dynamic warm-up model increases quadriceps strength and hamstring flexibility. *Journal of Strength and Conditioning Research*, *26*(4), 1130–1141. <https://doi.org/10.1519/JSC.0b013e31822e58b6>
- Akagi, R., Chino, K., Dohi, M., & Takahashi, H. (2012). Relationships between muscle size and hardness of the medial gastrocnemius at different ankle joint angles in young men. *Acta Radiologica*, *53*, 307–311. <https://doi.org/10.1258/ar.2011.110481>
- Akagi, R., & Takahashi, H. (2013). Acute effect of static stretching on hardness of the gastrocnemius muscle. *Medicine and Science in Sports and Exercise*, *45*(7), 1348–1354. <https://doi.org/10.1249/MSS.0b013e3182850e17>
- Akagi, R., & Takahashi, H. (2014). Effect of a 5-week static stretching program on hardness of the gastrocnemius muscle. *Scandinavian Journal of Medicine and Science in Sports*, *24*(6), 950–957. <https://doi.org/10.1111/sms.12111>
- Albracht, K., & Arampatzis, A. (2013). Exercise-induced changes in triceps surae tendon stiffness and muscle strength affect running economy in humans. *European Journal of Applied Physiology*, *113*(6), 1605–1615. <https://doi.org/10.1007/s00421-012-2585-4>
- Alegre, L., Jiménez, F., Gonzalo-Orden, J., Martín-Acero, R., & Aguado, X. (2006). Effects of dynamic resistance training on fascicle length and isometric strength. *Journal of Sports Sciences*, *24*(5), 501–508. <https://doi.org/10.1080/02640410500189322>
- Alexander, R. (1977). Muscle energetics and animal locomotion. In R. Alexander & G. Goldspink (Eds.), *Mechanics and energetics of animal locomotion* (pp. 57–
-

81). London: Chapman and Hall.

Alexander, R. (1987). The spring in your step. *New Scientist*, 114, 42–44.

Alexander, R., & Bennet-Clark, H. (1977). Storage of elastic strain energy in muscle and other tissues. *Nature*, 265(5590), 114–117.

<https://doi.org/10.1038/265114a0>

Allison, S., Bailey, D., & Folland, J. (2008). Prolonged static stretching does not influence running economy despite changes in neuromuscular function. *Journal of Sports Sciences*, 26(14), 1489–1495.

<https://doi.org/10.1080/02640410802392715>

Alter, M. (2004). *Science of flexibility* (3rd ed.). Champaign, IL: Human Kinetics.

Amiri-Khorasani, M., Abu Osman, N., & Yusof, A. (2011). Acute effect of static and dynamic stretching on hip dynamic range of motion during instep kicking in professional soccer players. *Journal of Strength and Conditioning Research*, 25(6), 1647–1652. <https://doi.org/10.1519/JSC.0b013e3181db9f41>

Amiri-Khorasani, M., Sahebozamani, M., Tabrizi, K., & Yusof, A. (2010). Acute effect of different stretching methods on Illinois agility Test in soccer players. *Journal of Strength and Conditioning Research*, 24(10), 2698–2704.

<https://doi.org/10.1519/JSC.0b013e3181bf049c>

Amiri-Khorasani, M., & Sotoodeh, V. (2013). The acute effects of combined static and dynamic stretch protocols on fitness performances in soccer players. *The Journal of Sports Medicine and Physical Fitness*, 53(5), 559–565. Retrieved from <http://europepmc.org/abstract/med/23903537>

Anderson, B. (1980). *Stretching*. Bolinas, CA: Shelter Publications.

Anderson, T. (1996). Biomechanics and running economy. *Sports Medicine*, 22(2), 76–89. <https://doi.org/10.2165/00007256-199622020-00003>

Apkarian, A., Bushnell, M., Treede, R., & Zubieta, J. (2005). Human brain

-
- mechanisms of pain perception and regulation in health and disease. *European Journal of Pain*, 9(4), 463–484. <https://doi.org/10.1016/j.ejpain.2004.11.001>
- Apostolopoulos, N., Metsios, G., Flouris, A., Koutedakis, Y., & Wyon, M. (2015). The relevance of stretch intensity and position—a systematic review. *Frontiers in Psychology*, 6(August), 1128. <https://doi.org/10.3389/fpsyg.2015.01128>
- Arampatzis, A., De Monte, G., Karamanidis, K., Morey-Klapsing, G., Stafilidis, S., & Brüggemann, G. (2006). Influence of the muscle-tendon unit's mechanical and morphological properties on running economy. *The Journal of Experimental Biology*, 209(17), 3345–3357. <https://doi.org/10.1242/jeb.02340>
- Arampatzis, A., Knicker, A., Metzler, V., & Brüggemann, G. (2000). Mechanical power in running: a comparison of different approaches. *Journal of Biomechanics*, 33(4), 457–463. [http://doi.org/https://doi.org/10.1016/S0021-9290\(99\)00187-6](http://doi.org/https://doi.org/10.1016/S0021-9290(99)00187-6)
- Arampatzis, A., Stafilidis, S., DeMonte, G., Karamanidis, K., Morey-Klapsing, G., & Brüggemann, G. (2005). Strain and elongation of the human gastrocnemius tendon and aponeurosis during maximal plantarflexion effort. *Journal of Biomechanics*, 38(4), 833–841. <http://doi.org/10.1016/j.jbiomech.2004.04.031>
- Arendt-Nielsen, L., & Mills, K. (1988). Muscle fibre conduction velocity, mean power frequency, mean EMG voltage and force during submaximal fatiguing contractions of human quadriceps. *European Journal of Applied Physiology and Occupational Physiology*, 58(1–2), 20–25. <https://doi.org/10.1007/BF00636598>
- Armstrong, R., Duan, C., Delp, M., Hayes, D., Glenn, G., & Allen, G. (1993). Elevations in rat soleus muscle [Ca²⁺] with passive stretch. *Journal of Applied Physiology*, 74(6), 2990–2997. Retrieved from <http://jap.physiology.org/content/jap/74/6/2990.full.pdf>
- Aruin, A., Prilutskii, B., Raitsin, L., & Savel'ev, I. (1979). Biomechanical properties of muscles and efficiency of movement. *Human Physiology*, 5(4), 426–434.
- Astrand, P., Rodahl, K., Dahl, H., & Stromme, S. (2003). *Textbook of work*
-

physiology: Physiological basis of exercise (4th ed.). Champaign, IL: Human Kinetics.

- Ateş, F., Hug, F., Bouillard, K., Jubeau, M., Frappart, T., Couade, M., ... Nordez, A. (2015). Muscle shear elastic modulus is linearly related to muscle torque over the entire range of isometric contraction intensity. *Journal of Electromyography and Kinesiology*, *25*(4), 703–708. <https://doi.org/10.1016/j.jelekin.2015.02.005>
- Atkinson, G., & Batterham, A. (2015). True and false interindividual differences in the physiological response to an intervention. *Experimental Physiology*, *100*(6), 577–588. <https://doi.org/10.1113/EP085070>
- Atkinson, G., & Nevill, A. (1998). Statistical methods for assessing measurement error (reliability) in variables relevant to sports medicine. *Sports Medicine*, *26*(4), 217–238. <https://doi.org/10.2165/00007256-199826040-00002>
- Avela, J., Finni, T., Liikavainio, T., Niemelä, E., & Komi, P. (2004). Neural and mechanical responses of the triceps surae muscle group after 1 h of repeated fast passive stretches. *Journal of Applied Physiology*, *96*, 2325–2332. <https://doi.org/10.1152/japplphysiol.01010.2003>
- Avela, J., Kyröläinen, H., & Komi, P. (1999). Altered reflex sensitivity after repeated and prolonged passive muscle stretching. *Journal of Applied Physiology*, *86*(4), 1283–1291. Retrieved from <http://jap.physiology.org/content/jap/86/4/1283.full.pdf>
- Ayala, F., Croix, M., Baranda, P., & Santonja, F. (2013). Acute effects of static and dynamic stretching on hamstring eccentric isokinetic strength and unilateral hamstring to quadriceps strength ratios. *Journal of Sports Sciences*, *31*(8), 831–839. <https://doi.org/10.1080/02640414.2012.751119>
- Ayala, F., De Ste Croix, M., Sainz de Baranda, P., & Santonja, F. (2014). Acute effects of static and dynamic stretching on hamstrings' response times. *Journal of Sports Sciences*, *32*(9), 817–825. <https://doi.org/10.1080/02640414.2013.861606>
-

- Babault, N., Desbrosses, K., Fabre, M., Michaut, A., & Pousson, M. (2006). Neuromuscular fatigue development during maximal concentric and isometric knee extensions. *Journal of Applied Physiology*, *100*(3), 780–785. <https://doi.org/10.1152/jappphysiol.00737.2005>
- Babault, N., Kouassi, B., & Desbrosses, K. (2010). Acute effects of 15 min static or contract-relax stretching modalities on plantar flexors neuromuscular properties. *Journal of Science and Medicine in Sport*, *13*(2), 247–252. <https://doi.org/10.1016/j.jsams.2008.12.633>
- Babic, J., & Lenarcic, J. (2004). In vivo determination of triceps surae muscle-tendon complex viscoelastic properties. *European Journal of Applied Physiology*, *92*(4–5), 477–484. <https://doi.org/10.1007/s00421-004-1107-4>
- Bacurau, R., Monteiro, G., Ugrinowitsch, C., Tricoli, V., Cabral, L., & Aoki, M. (2009). Acute effect of a ballistic and a static stretching exercise bout on flexibility and maximal strength. *Journal of Strength and Conditioning Research*, *23*(1), 304–308. <https://doi.org/10.1519/JSC.0b013e3181874d55>
- Baltzopoulos, V. (2008). Isokinetic dynamometry. In C. J. Payton & R. M. Bartlett (Eds.), *Biomechanical evaluation of movement in sport and exercise: The British Association of Sport and Exercise Sciences Guidelines* (pp. 103–128). London: Routledge. <http://doi.org/10.4324/9780203935750>
- Baltzopoulos, V., & Gleeson, N. (2001). Skeletal muscle function. In R. G. Eston & T. Reilly (Eds.), *Kinanthropometry and exercise physiology laboratory manual: Tests, procedures and data: physiology* (pp. 3–40). London: Routledge.
- Baltzopoulos, V., & Kellis, E. (1998). Isokinetic strength during childhood and adolescence. In E. Van Praagh (Ed.), *Pediatric anaerobic performance*. (pp. 225–240). Champaign, IL.: Human Kinetics.
- Baltzopoulos, V., & Maganaris, C. (2009). Biomechanics of human movement and muscle-tendon function. In *Olympic textbook of science in sport* (pp. 213–229). Oxford, UK: Wiley-Blackwell. <https://doi.org/10.1002/9781444303315.ch14>
-

- Bandy, W., & Irion, J. (1994). The effect of time on static stretch on the flexibility of the hamstring muscles. *Physical Therapy, 74*(9), 845–850.
<https://doi.org/10.1093/ptj/74.9.845>
- Bandy, W., Irion, J., & Briggler, M. (1997). The effect of time and frequency of static stretching on flexibility of the hamstring muscles. *Physical Therapy, 77*(10), 1090–1096. <https://doi.org/10.1093/ptj/77.10.1090>
- Bandy, W., Irion, J., & Briggler, M. (1998). The effect of static stretch and dynamic range of motion training on the flexibility of the hamstring muscles. *The Journal of Orthopaedic and Sports Physical Therapy, 27*(4), 295–300.
<https://doi.org/10.2519/jospt.1998.27.4.295>
- Barker, A., Jalinous, R., & Freeston, I. (1985). Non-invasive magnetic stimulation of human motor cortex. *The Lancet, 325*(8437), 1106–1107.
[https://doi.org/10.1016/S0140-6736\(85\)92413-4](https://doi.org/10.1016/S0140-6736(85)92413-4)
- Barnes, K., & Kilding, A. (2015a). Running economy: measurement, norms, and determining factors. *Sports Medicine - Open, 1*(1), 8.
<https://doi.org/10.1186/s40798-015-0007-y>
- Barnes, K., & Kilding, A. (2015b). Strategies to improve running economy. *Sports Medicine, 45*(1), 37–56. <https://doi.org/10.1007/s40279-014-0246-y>
- Barnes, K., Mcguigan, M., Barnes, K., Hopkins, W., Mcguigan, M., & Kilding, A. (2013). Effects of different uphill interval-training programs on running economy and performance. *International Journal of Sports Physiology and Performance, 8*(November), 639–647. <https://doi.org/10.1016/j.jsams.2012.11.035>
- Barnes, K., Mcguigan, M., & Kilding, A. (2014). Lower-body determinants of running economy in male and female distance runners. *Journal of Strength and Conditioning Research, 28*(5), 1289–1297.
<https://doi.org/10.1519/JSC.0000000000000267>
- Barry, P., Scott, G., John, A., & William, E. (2000). Mechanisms of anterior cruciate ligament injury. *Orthopedics, 23*(6), 573–578. <https://doi.org/10.3928/0147->
-

7447-20000601-15

- Basford, J., Jenkyn, T., An, K., Ehman, R., Heers, G., & Kaufman, K. (2002). Evaluation of healthy and diseased muscle with magnetic resonance elastography. *Archives of Physical Medicine and Rehabilitation*, 83(11), 1530–1536. <https://doi.org/10.1053/apmr.2002.35472>
- Batista, M., Ugrinowitsch, C., Roschel, H., Lotufo, R., Ricard, M., & Tricoli, V. (2007). Intermittent exercise as a conditioning activity to induce postactivation potentiation. *The Journal of Strength and Conditioning Research*, 21(3), 837–840. <http://doi.org/10.1519/R-20586.1>
- Batterham, A., & Hopkins, W. (2006). Making meaningful inferences about magnitudes. *International Journal of Sports Physiology and Performance*, 1(1), 50–57. <https://doi.org/10.1123/ijsp.1.1.50>
- Beaudoin, C., & Whatley Blum, J. (2005). Flexibility and running economy in female collegiate track athletes. *Journal of Sports Medicine and Physical Fitness*, 45(3), 295–300. <https://doi.org/10.1097/00005768-200105001-00128>
- Beedle, B., Rytter, S., Healy, R., & Ward, T. (2008). Pretesting static and dynamic stretching does not affect maximal strength. *Journal of Strength and Conditioning Research*, 22(6), 1838–1843. <https://doi.org/10.1519/JSC.0b013e3181821bc9>
- Behm, D., Bambury, A., Cahill, F., & Power, K. (2004). Effect of acute static stretching on force, balance, reaction time, and movement time. *Medicine and Science in Sports and Exercise*, 36(8), 1397–1402. <https://doi.org/10.1249/01.MSS.0000135788.23012.5F>
- Behm, D., Blazevich, A., Kay, A., & McHugh, M. (2015). Acute effects of muscle stretching on physical performance, range of motion, and injury incidence in healthy active individuals: a systematic review. *Applied Physiology, Nutrition, and Metabolism*, 41(1), 1–11. <https://doi.org/10.1139/apnm-2015-0235>
- Behm, D., Button, D., & Butt, J. (2001). Factors affecting force loss with prolonged
-

stretching. *Canadian Journal of Applied Physiology*, 26(3), 261–272.

<https://doi.org/10.1139/h01-017>

Behm, D., & Chaouachi, A. (2011). A review of the acute effects of static and dynamic stretching. *European Journal of Applied Physiology*, 111(11), 2633–2651. <https://doi.org/10.1007/s00421-011-1879-2>

Behm, D., Plewe, S., Grage, P., Rabbani, A., Beigi, H., Byrne, J., & Button, D. (2011). Relative static stretch-induced impairments and dynamic stretch-induced enhancements are similar in young and middle-aged men. *Applied Physiology, Nutrition, and Metabolism*, 36(6), 790–797. <https://doi.org/10.1139/h11-107>

Belkhiria-Turki, L., Chaouachi, A., Turki, O., Hammami, R., Chtara, M., Amri, M., ... Behm, D. (2014). Greater volumes of static and dynamic stretching within a warm-up do not impair star excursion balance performance. *Journal of Sports Medicine and Physical Fitness*, 54(3), 279–288. <https://doi.org/R40Y2014N03A0279> [pii]

Ben, M., & Harvey, L. (2010). Regular stretch does not increase muscle extensibility: A randomized controlled trial. *Scandinavian Journal of Medicine and Science in Sports*, 20(1), 136–144. <https://doi.org/10.1111/j.1600-0838.2009.00926.x>

Benetazzo, L., Bizzego, A., De Caro, R., Frigo, G., Guidolin, D., & Stecco, C. (2011). 3D reconstruction of the crural and thoracolumbar fasciae. *Surgical and Radiologic Anatomy*, 33(10), 855–862. <https://doi.org/10.1007/s00276-010-0757-7>

Benjamin, M. (2009). The fascia of the limbs and back - A review. *Journal of Anatomy*, 214(1), 1–18. <https://doi.org/10.1111/j.1469-7580.2008.01011.x>

Benjamin, M., & Ralphs, J. (1997). Tendons and ligaments - An overview. *Histology and Histopathology*, 12(4), 1135–1144. <https://doi.org/10.1016/B978-0-323-09138-1.00007-3>

Bensamoun, S., Ringleb, S., Chen, Q., Ehman, R., An, K., & Brennan, M. (2007). Thigh muscle stiffness assessed with magnetic resonance elastography in

-
- hyperthyroid patients before and after medical treatment. *Journal of Magnetic Resonance Imaging*, 26(3), 708–713. <https://doi.org/10.1002/jmri.21073>
- Bercoff, J., Tanter, M., & Fink, M. (2004). Supersonic shear imaging : A new technique. *IEEE Transactions on Ultrasonics, Ferroelectrics and Frequency Control*, 51(4), 396–409. <https://doi.org/10.1109/TUFFC.2004.1295425>
- Biewener, A. (1997). Effects of elastic energy storage on muscle work and efficiency. *Journal of Applied Biomechanics*, 13(4), 422–426. <https://doi.org/10.1123/jab.13.4.422>
- Biewener, A., & Baudinette, R. (1995). In vivo muscle force and elastic energy storage during steady-speed hopping of tammar wallabies (*Macropus eugenii*). *The Journal of Experimental Biology*, 198(9), 1829–1841. Retrieved from <http://jeb.biologists.org/content/198/9/1829.abstract>
- Bishop, D. (2003a). Warm up I: Potential mechanisms and the effects of passive warm up on exercise performance. *Sports Medicine*, 33(6), 439–454. <https://doi.org/10.2165/00007256-200333060-00005>
- Bishop, D. (2003b). Warm up II: Performance changes following active warm up and how to structure the warm up. *Sports Medicine*, 33(7), 483–498. <https://doi.org/10.2165/00007256-200333070-00002>
- Björklund, M., Djupsjöbacka, M., & Crenshaw, A. (2006). Acute muscle stretching and shoulder position sense. *Journal of Athletic Training*, 41(3), 270–274. [https://doi.org/10.1016/S0162-0908\(08\)70082-5](https://doi.org/10.1016/S0162-0908(08)70082-5)
- Björklund, M., Hamberg, J., & Crenshaw, A. (2001). Sensory adaptation after a 2-week stretching regimen of the rectus femoris muscle. *Archives of Physical Medicine and Rehabilitation*, 82(9), 1245–1250. <https://doi.org/10.1053/apmr.2001.24224>
- Blazevich, A. (2011). The stretch-shortening cycle (SSC). In M. Cardinale, R. Newton, & K. Nosaka (Eds.), *Strength and conditioning: Biological principles and practical applications* (pp. 209–222). Chichester, England: Wiley-Blackwell.
-

- Blazevich, A., Cannavan, D., Horne, S., Coleman, D., & Aagaard, P. (2009). Changes in muscle force–length properties affect the early rise of force in vivo. *Muscle and Nerve*, 39(4), 512–520. <https://doi.org/10.1002/mus.21259>
- Blazevich, A., Cannavan, D., Waugh, C., Miller, S., Thorlund, J., Aagaard, P., & Kay, A. (2014). Range of motion, neuromechanical, and architectural adaptations to plantar flexor stretch training in humans. *Journal of Applied Physiology*, 117(5), 452–462. <https://doi.org/10.1152/jappphysiol.00204.2014>
- Blazevich, A., Gill, N., Bronks, R., & Newton, R. (2003). Training-specific muscle architecture adaptation after 5-wk training in athletes. *Medicine and Science in Sports and Exercise*, 35(12), 2013–2022. <https://doi.org/10.1249/01.MSS.0000099092.83611.20>
- Blazevich, A., & Giorgi, A. (2001). Effect of testosterone administration and weight training on muscle architecture. *Medicine and Science in Sports and Exercise*, 33(10), 1688–1693. <https://doi.org/10.1097/00005768-200110000-00012>
- Blazevich, A., Horne, S., Cannavan, D., Coleman, D., & Aagaard, P. (2008). Effect of contraction mode of slow-speed resistance training on the maximum rate of force development in the human quadriceps. *Muscle and Nerve*, 38(3), 1046–1133. <https://doi.org/10.1002/mus.21021>
- Blickhan, R. (1989). The spring-mass model for running and hopping. *Journal of Biomechanics*, 22(11–12), 1217–1227. [https://doi.org/10.1016/0021-9290\(89\)90224-8](https://doi.org/10.1016/0021-9290(89)90224-8)
- Bonacci, J., Chapman, A., Blanch, P., & Vicenzino, B. (2009). Neuromuscular adaptations to training, injury and passive interventions. *Sports Medicine*, 39(11), 903–921. <https://doi.org/10.2165/11317850-000000000-00000>
- Bouillard, K., Hug, F., Guével, A., & Nordez, A. (2012). Shear elastic modulus can be used to estimate an index of individual muscle force during a submaximal isometric fatiguing contraction. *Journal of Applied Physiology*, 113(9), 1353–1361. <https://doi.org/10.1152/jappphysiol.00858.2012>
-

- Bouillard, K., Nordez, A., & Hug, F. (2011). Estimation of individual muscle force using elastography. *PLoS ONE*, 6(12), e29261. <https://doi.org/10.1371/journal.pone.0029261>
- Bouissou, P., Estrade, P., Goubel, F., Guezennec, C., & Serrurier, B. (1989). Surface EMG power spectrum and intramuscular pH in human vastus lateralis muscle during dynamic exercise. *Journal of Applied Physiology*, 67(3), 1245–1249. Retrieved from <http://jap.physiology.org/content/67/3/1245.full.pdf>
- Bouvier, T., Opplert, J., Cometti, C., & Babault, N. (2017). Acute effects of static stretching on muscle-tendon mechanics of quadriceps and plantar flexor muscles. *European Journal of Applied Physiology*, 117(7), 1309–1315. <http://doi.org/10.1007/s00421-017-3618-9>
- Boyle, P. (2004). The effect of static and dynamic stretching on muscle force production. *Journal of Sports Sciences*, 22(3), 273–274.
- Brandenburg, J., Eby, S., Song, P., Zhao, H., Brault, J., Chen, S., & An, K. (2014). Ultrasound elastography: The new frontier in direct measurement of muscle stiffness. *Archives of Physical Medicine and Rehabilitation*, 95(11), 2207–2219. <https://doi.org/10.1016/j.apmr.2014.07.007>
- Brenner, B., & Eisenberg, E. (1987). The mechanism of muscle contraction. Biochemical, mechanical, and structural approaches to elucidate cross-bridge action in muscle. In R. Jacob, H. Just, & C. Holubarsch (Eds.), *Cardiac Energetics: Basic Mechanisms and Clinical Implications* (pp. 3–16). Heidelberg: Steinkopff. https://doi.org/10.1007/978-3-662-11289-2_1
- Brockett, C., Morgan, D., & Proske, U. (2001). Human hamstring muscles adapt to eccentric exercise by changing optimum length. *Medicine and Science in Sports and Exercise*, 33(5), 783–790. <https://doi.org/10.1097/00005768-200105000-00017>
- Brown, P., Hughes, M., & Tong, R. (2008). The effect of warm-up on high-intensity, intermittent running using nonmotorized treadmill ergometry. *Journal of Strength and Conditioning Research*, 22(3), 801–808.
-

<https://doi.org/10.1519/JSC.0b013e31816a5775>

- Brughelli, M., & Cronin, J. (2007). Altering the length-tension relationship with eccentric exercise. *Sports Medicine*, 37(9), 807–826.
<https://doi.org/10.2165/00007256-200737090-00004>
- Bruton, J., Lännergren, J., & Westerblad, H. (1996). Effects of repetitive tetanic stimulation at long intervals on excitation-contraction coupling in frog skeletal muscle. *The Journal of Physiology*, 495(1), 15–22.
<https://doi.org/10.1113/jphysiol.1996.sp021570>
- Buchthal, F., Kaiser, E., & Knappeis, G. (1944). Elasticity, viscosity and plasticity in the cross striated muscle fibre. *Acta Physiologica Scandinavica*, 8(1), 16–37.
<http://doi.org/10.1111/j.1748-1716.1944.tb03048.x>
- Buckley, J. (2008). *Exercise physiology in special populations*. (N. Spurway, Ed.). Philadelphia, PA: Churchill Livingstone/Elsevier.
- Budini, F., & Markus, T. (2016). Changes in H-reflex amplitude to muscle stretch and lengthening in humans. *Reviews in the Neurosciences*, 27(5), 511–522.
<https://doi.org/10.1515/revneuro-2016-0001>
- Burke, D., Andrews, C., & Ashby, P. (1971). Autogenic effects of static muscle stretch in spastic man. *Archives of Neurology*, 25(4), 367–372.
<https://doi.org/10.1001/archneur.1971.00490040093011>
- Burke, D., Culligan, C., & Holt, L. (2000). The theoretical basis of proprioceptive neuromuscular facilitation. *Journal of Strength and Conditioning Research*, 14(4), 496–500. <https://doi.org/10.1519/00124278-200011000-00020>
- Butler, R., Crowell, H., & Davis, I. (2003). Lower extremity stiffness: Implications for performance and injury. *Clinical Biomechanics*, 18(6), 511–517.
[https://doi.org/10.1016/S0268-0033\(03\)00071-8](https://doi.org/10.1016/S0268-0033(03)00071-8)
- Butler, R., Davis, I., & Hamill, J. (2006). Interaction of arch type and footwear on running mechanics. *The American Journal of Sports Medicine*, 34(12), 1998–
-

2005. <https://doi.org/10.1177/0363546506290401>

Byrne, P., Kenny, J., & O' Rourke, B. (2014). Acute potentiating effect of depth jumps on sprint performance. *Journal of Strength and Conditioning Research*, 28(3), 610–615. <https://doi.org/10.1519/JSC.0b013e3182a0d8c1>

Caiozzo, V. (2002). Plasticity of skeletal muscle phenotype: Mechanical consequences. *Muscle and Nerve*, 26(6), 740–768. <https://doi.org/10.1002/mus.10271>

Calve, S., Dennis, R., Kosnik, P., Baar, K., Grosh, K., & Arruda, E. (2004). Engineering of functional tendon. *Tissue Engineering*, 10(5–6), 755–761. <https://doi.org/10.1089/1076327041348464>

Caplan, N., Rogers, R., Parr, M., & Hayes, P. (2009). The effect of proprioceptive neuromuscular facilitation and static stretch training on running mechanics. *Journal of Strength and Conditioning Research*, 23(4), 1175–1180. <https://doi.org/10.1519/JSC.0b013e318199d6f6>

Cappozzo, A., Catani, F., Della Croce, U., & Leardini, A. (1995). Position and orientation in space of bone during movement: anatomical frame definition and determination. *Clinical Biomechanics*, 10(4), 171–178. [https://doi.org/http://dx.doi.org/10.1016/0268-0033\(95\)91394-T](https://doi.org/http://dx.doi.org/10.1016/0268-0033(95)91394-T)

Carter, J., & Greenwood, M. (2015). Does flexibility exercise affect running economy? A brief review. *Strength and Conditioning Journal*, 37(3), 12–21. <https://doi.org/10.1519/SSC.0000000000000127>

Carvalho, F., Carvalho, M., Simão, R., Gomes, T., Costa, P., Neto, L., ... Dantas, E. (2012). Acute effects of a warm-up including active, passive, and dynamic stretching on vertical jump performance. *Journal of Strength and Conditioning Research*, 26(9), 2447–2452. <https://doi.org/10.1519/JSC.0b013e31823f2b36>

Cavagna, G., Citterio, G., & Jacini, P. (1981). Effects of speed and extent of

-
- stretching on the elastic properties of active frog muscle. *Journal of Experimental Biology*, 91(1), 131–143. Retrieved from <http://jeb.biologists.org/content/91/1/131>
- Cavagna, G., Dusman, B., & Margaria, R. (1968). Positive work done by a previously stretched muscle. *Journal of Applied Physiology*, 24(1), 21–32. Retrieved from <http://jap.physiology.org/content/jap/24/1/21.full.pdf>
- Cavagna, G., & Kaneko, M. (1977). Mechanical work and efficiency in level walking and running. *The Journal of Physiology*, 268(2), 467–481. <https://doi.org/10.1113/jphysiol.1977.sp011866>
- Cavanagh, P., & Komi, P. (1979). Electromechanical delay in human skeletal muscle under concentric and eccentric contractions. *European Journal of Applied Physiology and Occupational Physiology*, 42(3), 159–163. <https://doi.org/10.1007/BF00431022>
- Cavanagh, P., & Kram, R. (1985). The efficiency of human movement—a statement of the problem. *Medicine and Science in Sports and Exercise*, 17(3), 304–308. <https://doi.org/10.1249/00005768-198506000-00002>
- Chalmers, G. (2004). Re-examination of the possible role of Golgi tendon organ and muscle spindle reflexes in proprioceptive neuromuscular facilitation muscle stretching. *Sports Biomechanics*, 3(1), 159–183. <https://doi.org/10.1080/14763140408522836>
- Chan, S., Hong, Y., & Robinson, P. (2001). Flexibility and passive resistance of the hamstrings of young adults using two different static stretching protocols. *Scandinavian Journal of Medicine and Science in Sports*, 11(1990), 81–86. <https://doi.org/10.1034/j.1600-0838.2001.011002081.x>
- Chaouachi, A., Castagna, C., Chtara, M., Brughelli, M., Turki, O., Galy, O., ... Behm, D. (2010). Effect of warm-ups involving static or dynamic stretching on agility, sprinting, and jumping performance in trained individuals. *Journal of Strength*
-

and Conditioning Research, 24(8), 2001–2011.

<https://doi.org/10.1519/JSC.0b013e3181aeb181>

Chapman, A. (1974). The relation between length and the force-velocity curve of a single equivalent linear muscle during flexion of the elbow. In R. C. Nelson & C. A. Morehouse (Eds.), *Biomechanics IV: Proceedings of the Fourth International Seminar on Biomechanics, University Park, Pennsylvania* (pp. 434–439). London: Macmillan Education UK. https://doi.org/10.1007/978-1-349-02612-8_65

Charvet, B., Ruggiero, F., & Le Guellec, D. (2012). The development of the myotendinous junction. A review. *Muscles, Ligaments and Tendons Journal*, 2(2), 53–63. Retrieved from <https://www.mltj.org/common/php/portiere.php?ID=deeea62ff7e2661d148f895cc39dfc3a>

Chatton, C., Brown, L., Coburn, J., & Noffal, G. (2010). Effect of a dynamic loaded warm-up on vertical jump performance. *Journal of Strength and Conditioning Research*, 24(7), 1751–1754. <https://doi.org/10.1519/JSC.0b013e3181ddf665>

Chatzopoulos, D., Galazoulas, C., Patikas, D., & Kotzamanidis, C. (2014). Acute effects of static and dynamic stretching on balance, agility, reaction time and movement time. *Journal of Sports Science and Medicine*, 13(2), 403–409. <https://doi.org/10.1080/02640414.2013.861606>

Chatzopoulos, D., Michailidis, C., Giannakos, A., Alexiou, K., Patikas, D., Antonopoulos, C., & Kotzamanidis, C. (2007). Postactivation potentiation effects after heavy resistance exercise on running speed. *Journal of Strength and Conditioning Research*, 21(4), 1278–1281. <https://doi.org/10.1519/R-21276.1>

Chaudhry, H., Schleip, R., Ji, Z., Bukiet, B., Maney, M., & Findley, T. (2008). Three-dimensional mathematical model for deformation of human fasciae in manual therapy. *The Journal of the American Osteopathic Association*, 108(8), 379–390. <https://doi.org/10.7556/jaoa.2008.108.8.379>

Chernak, L., DeWall, R., Lee, K., & Thelen, D. (2013). Length and activation

dependent variations in muscle shear wave speed. *Physiological Measurement*, 34(6), 713–721. <https://doi.org/10.1088/0967-3334/34/6/713>

Chino, K., & Takahashi, H. (2015). The association of muscle and tendon elasticity with passive joint stiffness: In vivo measurements using ultrasound shear wave elastography. *Clinical Biomechanics*, 30(10), 1230–1235. <https://doi.org/10.1016/j.clinbiomech.2015.07.014>

Chiu, L., Fry, A., Weiss, L., Schilling, B., Brown, L., & Smith, S. (2003). Postactivation potentiation response in athletic and recreationally trained individuals. *Journal of Strength and Conditioning Research*, 17(4), 671–677. [https://doi.org/10.1519/1533-4287\(2003\)017<0671:ppriaa>2.0.co;2](https://doi.org/10.1519/1533-4287(2003)017<0671:ppriaa>2.0.co;2)

Chleboun, G., Howell, J., Conatser, R., & Giesey, J. (1998). Relationship between muscle swelling and stiffness after eccentric exercise. *Medicine and Science in Sports and Exercise*, 30(4), 529–535. <https://doi.org/10.1097/00005768-199804000-00010>

Christensen, B., & Nordstrom, B. (2008). The effects of proprioceptive neuromuscular facilitation and dynamic stretching techniques on vertical jump performance. *Journal of Strength and Conditioning Research*, 22(6), 1826–1831. <https://doi.org/10.1519/JSC.0b013e31817ae316>

Chtourou, H., Aloui, A., Hammouda, O., Chaouachi, A., Chamari, K., & Souissi, N. (2013). Effect of static and dynamic stretching on the diurnal variations of jump performance in soccer players. *PLoS ONE*, 8(8), 1–6. <https://doi.org/10.1371/journal.pone.0070534>

Ciccarelli, O., Toosy, A., Marsden, J., Wheeler-Kingshott, C., Sahyoun, C., Matthews, P., ... Thompson, A. (2005). Identifying brain regions for integrative sensorimotor processing with ankle movements. *Experimental Brain Research*, 166(1), 31–42. <https://doi.org/10.1007/s00221-005-2335-5>

Cifrek, M., Medved, V., Tonković, S., & Ostojić, S. (2009). Surface EMG based muscle fatigue evaluation in biomechanics. *Clinical Biomechanics*, 24(4), 327–340. <https://doi.org/10.1016/j.clinbiomech.2009.01.010>

- Cipriani, D., Terry, M., Haines, M., Tabibnia, A., & Lyssanova, O. (2012). Effect of stretch frequency and sex on the rate of gain and rate of loss in muscle flexibility during a hamstring-stretching program: a randomized single-blind longitudinal study. *Journal of Strength and Conditioning Research*, 26(8), 2119–2129. <https://doi.org/10.1519/JSC.0b013e31823b862a>
- Coggeshall, R., Ah Park Hong, K., Langford, L., Schaible, H., & Schmidt, R. (1983). Discharge characteristics of fine medial articular afferents at rest and during passive movements of inflamed knee joints. *Brain Research*, 272(1), 185–188. [https://doi.org/10.1016/0006-8993\(83\)90379-7](https://doi.org/10.1016/0006-8993(83)90379-7)
- Cohen, J. (1977). *Statistical power analysis for the behavioral sciences* (2nd ed.). Hillsdale, NJ: Lawrence Erlbaum. <https://doi.org/10.1016/c2013-0-10517-x>
- Coleman, D., Cannavan, D., Horne, S., & Blazeovich, A. (2012). Leg stiffness in human running: Comparison of estimates derived from previously published models to direct kinematic-kinetic measures. *Journal of Biomechanics*, 45(11), 1987–1991. <https://doi.org/10.1016/j.jbiomech.2012.05.010>
- Comyns, T., Harrison, A., Hennessy, L., & Jensen, R. (2006). The optimal complex training rest interval for athletes from anaerobic sports. *Journal of Strength and Conditioning Research*, 20(3), 471–476. <http://doi.org/10.1519/18445.1>
- Conley, D., & Krahenbuhl, G. (1980). Running economy and distance running performance of highly trained athletes. *Medicine and Science in Sports and Exercise*, 12(5), 357–360. <https://doi.org/10.1249/00005768-198012050-00010>
- Cooke, C. (2001). Maximal oxygen uptake, economy and efficiency. In R. Eston & T. Reilly (Eds.), *Kinanthropometry and exercise physiology laboratory manual: Tests, procedures and data, Vol. 2: Exercise physiology* (pp. 161–191). London: Routledge.
-

- Cornelius, W., & Hinson, M. (1980). The relationship between isometric contractions of hip extensors and subsequent flexibility in males. *The Journal of Sports Medicine and Physical Fitness*, 20(1), 75–80.
- Cornu, C., Goubel, F., & Fardeau, M. (2001). Muscle and joint elastic properties during elbow flexion in Duchenne muscular dystrophy. *Journal of Physiology*, 533(2), 605–616. <https://doi.org/10.1111/j.1469-7793.2001.0605a.x>
- Cornwell, A., Nelson, A., & Sidaway, B. (2002). Acute effects of stretching on the neuromechanical properties of the triceps surae muscle complex. *European Journal of Applied Physiology*, 86(5), 428–434. <https://doi.org/10.1007/s00421-001-0565-1>
- Correas, J., Drakonakis, E., Isidori, A., Hélénon, O., Pozza, C., Cantisani, V., ... D'Ambrosio, F. (2014). Reprint of update on ultrasound elastography: Miscellanea. Prostate, testicle, musculo-skeletal. *European Journal of Radiology*, 83(3), 442–449. <https://doi.org/10.1016/j.ejrad.2014.01.018>
- Costa, P., Herda, T., Herda, A., & Cramer, J. (2014). Effects of dynamic stretching on strength, muscle imbalance, and muscle activation. *Medicine and Science in Sports and Exercise*, 46(3), 586–593. <https://doi.org/10.1249/MSS.0000000000000138>
- Costa, P., Ryan, E., Herda, T., Walter, A., Hoge, K., & Cramer, J. (2009). Acute effects of passive stretching on the electromechanical delay and evoked twitch properties. *European Journal of Applied Physiology*, 108(2), 301–310. <https://doi.org/10.1007/s00421-009-1214-3>
- Costill, D., Daniels, J., Evans, W., Fink, W., Krahenbuhl, G., & Saltin, B. (1976). Skeletal muscle enzymes and fiber composition in male and female track athletes. *Journal of Applied Physiology*, 40(2), 149–154. Retrieved from <http://jap.physiology.org/content/40/2/149>
- Costill, D., Thomason, H., & Roberts, E. (1973). Fractional utilization of the aerobic capacity during distance running. *Medicine and Science in Sports and Exercise*,
-

- Covert, C., Alexander, M., Petronis, J., & Davis, D. (2010). Comparison of ballistic and static stretching on hamstring muscle length using an equal stretching dose. *Journal of Strength and Conditioning Research*, *24*(11), 3008–3014. <https://doi.org/10.1519/JSC.0b013e3181bf3bb0>
- Craib, M., Mitchell, V., Fields, K., Cooper, T., Hopewell, R., & Morgan, D. (1996). The association between flexibility and running economy in sub-elite male distance runners. *Medicine and Science in Sports and Exercise*, *28*(6), 737–743. <https://doi.org/10.1017/CBO9781107415324.004>
- Cramer, J., Beck, T., Housh, T., Massey, L., Marek, S., Danglemeier, S., ... Egan, A. (2007). Acute effects of static stretching on characteristics of the isokinetic angle - torque relationship, surface electromyography, and mechanomyography. *Journal of Sports Sciences*, *25*(6), 687–698. <https://doi.org/10.1080/02640410600818416>
- Cramer, J., Housh, T., Johnson, G., Miller, J., Coburn, J., & Beck, T. (2004). Acute effects of static stretching on peak torque in women. *Journal of Strength and Conditioning Research*, *18*(2), 236–241. <https://doi.org/10.1519/R-13303.1>
- Cramer, J., Housh, T., Johnson, G., Weir, J., Beck, T., & Coburn, J. (2007). An acute bout of static stretching does not affect maximal eccentric isokinetic peak torque, the joint angle at peak torque, mean power, electromyography, or mechanomyography. *Journal of Orthopaedic & Sports Physical Therapy*, *37*(3), 130–139. [https://doi.org/10.1016/S0162-0908\(08\)79124-4](https://doi.org/10.1016/S0162-0908(08)79124-4)
- Cresswell, A., Löscher, W., & Thorstensson, A. (1995). Influence of gastrocnemius muscle length on triceps surae torque development and electromyographic activity in man. *Experimental Brain Research*, *105*(2), 283–290. <https://doi.org/10.1007/BF00240964>
- Cuissard, N., Duchateau, J., & Hainaut, K. (1988). Muscle stretching and motoneuron excitability. *European Journal of Applied Physiology and Occupational Physiology*, *58*(1–2), 47–52. <https://doi.org/10.1007/BF00636602>
-

- Curry, B., Chengkalath, D., Crouch, G., Romance, M., & Manns, P. (2009). Acute effects of dynamic stretching, static stretching, and light aerobic activity on muscular performance in women. *Journal of Strength and Conditioning Research*, 23(6), 1811–1819. <https://doi.org/10.1519/JSC.0b013e3181b73c2b>
- Cutts, A. (1988). The range of sarcomere lengths in the muscles of the human lower limb. *Journal of Anatomy*, 160, 79–88. Retrieved from <http://www.ncbi.nlm.nih.gov/pubmed/3253264>
- Dale, W., Baer, E., Keller, A., & Kohn, R. (1972). On the ultrastructure of mammalian tendon. *Experientia*, 28(11), 1293–1295. <https://doi.org/10.1007/BF01965303>
- Dalleau, G., Belli, A., Bourdin, M., & Lacour, J. (1998). The spring-mass model and the energy cost of treadmill running. *European Journal of Applied Physiology and Occupational Physiology*, 77(3), 257–263. <http://doi.org/10.1007/s004210050330>
- Dalrymple, K., Davis, S., Dwyer, G., & Moir, G. (2010). Effect of static and dynamic stretching on vertical jump performance in collegiate women volleyball players. *Journal of Strength and Conditioning Research*, 24(1), 149–155. <https://doi.org/10.1519/JSC.0b013e3181b29614>
- Daniels, J. (1985). A physiologist's view of running economy. *Medicine and Science in Sports and Exercise*, 17(3), 332–338.
- Daniels, J., & Daniels, N. (1992). Running economy of elite male and elite female runners. *Medicine and Science in Sports and Exercise*. <https://doi.org/10.1249/00005768-199204000-00015>
- Daniels, J., Yarbrough, R., & Foster, C. (1978). Changes in VO₂ max and running performance with training. *European Journal of Applied Physiology and Occupational Physiology*, 39(4), 249–254. <https://doi.org/10.1007/BF00421448>
- De-Doncker, L., Picquet, F., Petit, J., & Falempin, M. (2003). Effects of hypodynamia-hypokinesia on the muscle spindle discharges of rat soleus muscle. *Journal of Neurophysiology*, 89(6), 3000–3007.
-

<https://doi.org/10.1152/jn.00875.2002>

De Felipe, C., Herrero, J., O'Brien, J., Palmer, J., Doyle, C., Smith, A., ... Hunt, S. (1998). Altered nociception, analgesia and aggression in mice lacking the receptor for substance P. *Nature*, 392(6674), 394–397.

<https://doi.org/10.1038/32904>

Dechaumont-Palacin, S., Marque, P., De Boissezon, X., Castel-Lacanal, E., Carel, C., Berry, I., ... Loubinoux, I. (2008). Neural correlates of proprioceptive integration in the contralesional hemisphere of very impaired patients shortly after a subcortical stroke: An fMRI study. *Neurorehabilitation and Neural Repair*, 22(2), 154–165. <http://doi.org/10.1177/1545968307307118>

Decoster, L., Cleland, J., Altieri, C., & Russell, P. (2005). The effects of hamstring stretching on range of motion: A systematic literature review. *The Journal of Orthopaedic and Sports Physical Therapy*, 35(6), 377–387.

<https://doi.org/10.2519/jospt.2005.35.6.377>

Dee, K., Puleo, D., & Bizios, R. (2002). *An introduction to tissue-biomaterial interactions* (Vol. 4). New York, USA: John Wiley & Sons, Inc.

<https://doi.org/10.1002/0471270598>

Denadai, B., Ortiz, M., Greco, C., & de Mello, M. (2006). Interval training at 95% and 100% of the velocity at VO₂ max: effects on aerobic physiological indexes and running performance. *Applied Physiology, Nutrition and Metabolism*, 31(6), 737–743. <https://doi.org/10.1139/h06-080>

Desmond, J., & Glover, G. (2002). Estimating sample size in functional MRI (fMRI) neuroimaging studies: Statistical power analyses. *Journal of Neuroscience Methods*, 118(2), 115–128. [https://doi.org/10.1016/S0165-0270\(02\)00121-8](https://doi.org/10.1016/S0165-0270(02)00121-8)

Diamant, J., Keller, A., Baer, E., Litt, M., & Arridge, R. (1972). Collagen; Ultrastructure and Its Relation to Mechanical Properties as a Function of Ageing. *Proceedings of the Royal Society of London. Series B, Biological Sciences*, 180(1060), 293–315. Retrieved from <http://www.jstor.org/stable/76283>

- Dimoka, A. (2012). How to conduct a functional magnetic resonance (fMRI) study in social science research. *MIS Quarterly*, 36(3), 811–840.
<https://doi.org/10.2110/jsr.2005.053>
- Doroski, D., Brink, K., & Temenoff, J. (2007). Techniques for biological characterization of tissue-engineered tendon and ligament. *Biomaterials*, 28(2), 187–202. <https://doi.org/10.1016/j.biomaterials.2006.08.040>
- Dubois, G., Kheireddine, W., Vergari, C., Bonneau, D., Thoreux, P., Rouch, P., ... Skalli, W. (2015). Reliable protocol for shear wave elastography of lower limb muscles at rest and during passive stretching. *Ultrasound in Medicine and Biology*, 41(9), 2284–2291. <https://doi.org/10.1016/j.ultrasmedbio.2015.04.020>
- Duchateau, J., & Baudry, S. (2014). Insights into the neural control of eccentric contractions. *Journal of Applied Physiology*, 116(11), 1418–1425.
<https://doi.org/10.1152/jappphysiol.00002.2013>
- Eby, S., Song, P., Chen, S., Chen, Q., Greenleaf, J., & An, K. (2013). Validation of shear wave elastography in skeletal muscle. *Journal of Biomechanics*, 46(14), 2381–2387. <https://doi.org/10.1016/j.jbiomech.2013.07.033>
- Eccles, J., Eccles, R., & Lundberg, A. (1957). Synaptic actions on motoneurons caused by impulses in Golgi tendon organ afferents. *The Journal of Physiology*, 138(2), 227–252. <https://doi.org/10.1113/jphysiol.1957.sp005849>
- Edman, K. (1988). Double-hyperbolic force-velocity relation in frog muscle fibres. *The Journal of Physiology*, 404, 301–321.
<https://doi.org/10.1113/jphysiol.1988.sp017291>
- Edman, K., Grieve, D., & Nilsson, E. (1966). Studies of the excitation-contraction mechanism in the skeletal muscle and the myocardium. *Pflügers Archiv Für Die Gesamte Physiologie Des Menschen Und Der Tiere*, 290(4), 320–334.
<https://doi.org/10.1007/BF00363311>
- Edman, P. (2003). Contractile performance of skeletal muscle fibres. In P. V Komi (Ed.), *Strength and Power in Sport* (2nd ed., pp. 114–133). Oxford, UK: Blackwell
-

Science Ltd. <https://doi.org/10.1002/9780470757215.ch7>

- Elliott, D. (1965). Structure and function of mammalian tendon. *Biological Reviews*, 40(3), 392–421. <https://doi.org/10.1111/j.1469-185X.1965.tb00808.x>
- Enoka, R. (1994). *Neuromechanical basis of kinesiology*. Champaign, IL: Human Kinetics.
- Enoka, R. (2015). *Neuromechanics of human movement* (5th ed.). Champaign, IL: Human Kinetics.
- Esformes, J., Cameron, N., & Bampouras, T. (2010). Postactivation potentiation following different modes of exercise. *Journal of Strength and Conditioning Research*, 24(7), 1911–1916. <http://doi.org/10.1519/JSC.0b013e3181dc47f8>
- Etnyre, B., & Abraham, L. (1986a). Gains in range of ankle dorsiflexion using three popular stretching techniques. *American Journal of Physical Medicine*, 65(4), 189–196.
- Etnyre, B., & Abraham, L. (1986b). H-reflex changes during static stretching and two variations of proprioceptive neuromuscular facilitation techniques. *Electroencephalography and Clinical Neurophysiology*, 63(2), 174–179. [https://doi.org/10.1016/0013-4694\(86\)90010-6](https://doi.org/10.1016/0013-4694(86)90010-6)
- Evans, A., Collins, D., & Milner, B. (1992). An MRI-based stereotactic brain atlas from 300 young normal subjects. In *Proceedings of the 22nd Symposium of the Society for Neuroscience* (p. 408). Anaheim.
- Faigenbaum, A., Bellucci, M., Bernieri, A., Bakker, B., & Hoorens, K. (2005). Acute effects of different warm-up protocols on fitness performance in children. *The Journal of Strength and Conditioning Research*, 19(2), 376–381. <https://doi.org/10.1519/R-15344.1>
- Faigenbaum, A., Kang, J., McFarland, J., Bloom, J., Magnatta, J., Ratamess, N., & Hoffman, J. (2006). Acute effects of different warm-up protocols on anaerobic performance in teenage athletes. *Pediatric Exercise Science*, 18(1), 64–75. <https://doi.org/10.1123/pes.18.1.64>
-

- Farley, C., & Morgenroth, D. (1999). Leg stiffness primarily depends on ankle stiffness during human hopping. *Journal of Biomechanics*, 32(3), 267–273. [https://doi.org/10.1016/S0021-9290\(98\)00170-5](https://doi.org/10.1016/S0021-9290(98)00170-5)
- Farris, D., & Lichtwark, G. (2016). UltraTrack: Software for semi-automated tracking of muscle fascicles in sequences of B-mode ultrasound images. *Computer Methods and Programs in Biomedicine*, 128, 111–118. <https://doi.org/10.1016/j.cmpb.2016.02.016>
- Fayed, M. (2010). Architecture and functional specifications of the muscles of the antibrachium and manus regions of the African Ass. *Advances in Biological Research*, 4(1), 45–64.
- Feland, J., Myrer, J., Schulthies, S., Fellingham, G., & Measom, G. (2001). The effect of duration of stretching of the hamstring muscle group for increasing range of motion in people aged 65 years or older. *Physical Therapy*, 81(5), 1100–1117. <https://doi.org/10.1093/ptj/81.5.1110>
- Ferrauti, A., Bergermann, M., & Fernandez-Fernandez, J. (2010). Effects of a concurrent strength and endurance training on running performance and running economy in recreational marathon runners. *Journal of Strength and Conditioning Research*, 24(10), 2770–2778. <https://doi.org/10.1519/JSC.0b013e3181d64e9c>
- Ferrell, W. (1980). The adequacy of stretch receptors in the cat knee joint for signalling joint angle throughout a full range of movement. *The Journal of Physiology*, 299, 85–99. <https://doi.org/10.1113/jphysiol.1980.sp013112>
- Findley, T., Chaudhry, H., & Dhar, S. (2015). Transmission of muscle force to fascia during exercise. *Journal of Bodywork and Movement Therapies*, 19(1), 119–123. <https://doi.org/10.1016/j.jbmt.2014.08.010>
- Finni, T., Peltonen, J., Stenroth, L., & Cronin, N. (2013). Viewpoint: On the hysteresis in the human Achilles tendon. *Journal of Applied Physiology*, 114(4), 515–517. <https://doi.org/10.1152/jappphysiol.01005.2012>
-

- Fisher, R. (1921). On the probable error of a coefficient of correlation deduced from a small sample. *Metron*, (1), 3–32. Retrieved from <http://www.citeulike.org/group/894/article/2344770>
- Fletcher, I. (2010). The effect of different dynamic stretch velocities on jump performance. *European Journal of Applied Physiology*, 109(3), 491–498. <https://doi.org/10.1007/s00421-010-1386-x>
- Fletcher, I. (2013). An investigation into the effect of a pre-performance strategy on jump performance. *Journal of Strength and Conditioning Research*, 27(1), 107–115. <https://doi.org/10.1519/JSC.0b013e3182517ffb>
- Fletcher, I., & Anness, R. (2007). The acute effects of combined static and dynamic stretch protocols on fifty-meter sprint performances in track-and-field athletes. *Journal of Strength and Conditioning Research*, 21(3), 784–787. <https://doi.org/10.1519/r-19475.1>
- Fletcher, I., & Jones, B. (2004). The effect of different warm-up stretch protocols on 20 meter sprint performance in trained rugby union players. *Journal of Strength and Conditioning Research*, 18(4), 885–888. <https://doi.org/10.1017/CBO9781107415324.004>
- Fletcher, I., & Monte-Colombo, M. (2010a). An investigation into the effects of different warm-up modalities on specific motor skills related to soccer performance. *Journal of Strength and Conditioning Research*, 24(8), 2096–2101. <https://doi.org/10.1519/JSC.0b013e3181e312db>
- Fletcher, I., & Monte-Colombo, M. (2010b). An investigation into the possible physiological mechanisms associated with changes in performance related to acute responses to different preactivity stretch modalities. *Applied Physiology, Nutrition, and Metabolism*, 35(1), 27–34. <https://doi.org/10.1139/H09-125>
- Fletcher, J., Esau, S., & MacIntosh, B. (2010). Changes in tendon stiffness and running economy in highly trained distance runners. *European Journal of Applied Physiology*, 110(5), 1037–1046. <https://doi.org/10.1007/s00421-010->
-

- Fletcher, J., Groves, E., Pfister, T., & MacIntosh, B. (2013). Can muscle shortening alone, explain the energy cost of muscle contraction in vivo? *European Journal of Applied Physiology*, 113(9), 2313–2322. <https://doi.org/10.1007/s00421-013-2665-0>
- Fletcher, J., & MacIntosh, B. (2017). Running economy from a muscle energetics perspective. *Frontiers in Physiology*, 8(June), 433. <https://doi.org/10.3389/fphys.2017.00433>
- Fletcher, J., Pfister, T., & Macintosh, B. (2013). Energy cost of running and Achilles tendon stiffness in man and woman trained runners. *Physiological Reports*, 1(7), e00178. <https://doi.org/10.1002/phy2.178>
- Foley, J., Jayaraman, R., Prior, B., Pivarnik, J., & Meyer, R. (1999). MR measurements of muscle damage and adaptation after eccentric exercise. *Journal of Applied Physiology*, 87(6), 2311–2318. <https://doi.org/10.1097/00005768-199805001-00390>
- Folpp, H., Deall, S., Harvey, L., & Gwinn, T. (2006). Can apparent increases in muscle extensibility with regular stretch be explained by changes in tolerance to stretch? *Australian Journal of Physiotherapy*, 52(1), 45–50. [https://doi.org/10.1016/S0004-9514\(06\)70061-7](https://doi.org/10.1016/S0004-9514(06)70061-7)
- Folland, J., & Williams, A. (2007). The adaptations to strength training: Morphological and neurological contributions to increased strength. *Sports Medicine*, 37(2), 145–168. <https://doi.org/10.2165/00007256-200737020-00004>
- Fowles, J., Sale, D., & MacDougall, J. (2000). Reduced strength after passive stretch of the human plantarflexors. *Journal of Applied Physiology*, 89(3), 1179–1188. Retrieved from <http://jap.physiology.org/content/jap/89/3/1179.full.pdf>
-

- Fox, S. (2006). Mechanisms of contraction and neural control. In S. I. Fox (Ed.), *Human physiology* (9th ed., pp. 338–379). New York: McGraw-Hill.
- Franz, J., Paylo, K., Dicharry, J., Riley, P., & Kerrigan, D. (2009). Changes in the coordination of hip and pelvis kinematics with mode of locomotion. *Gait and Posture*, 29(3), 494–498. <http://doi.org/10.1016/j.gaitpost.2008.11.011>
- Franch, J., Madsen, K., Djurhuus, M., & Pedersen, P. (1998). Improved running economy following intensified training correlates with reduced ventilatory demands. *Medicine and Science in Sports and Exercise*, 30(8), 1250–1256.
- Frankel, V., & Burstein, A. (1970). *Orthopaedic Biomechanics*. Philadelphia, PA: Lea & Febiger.
- Franklin, D., Burdet, E., Osu, R., Kawato, M., & Milner, T. (2003). Functional significance of stiffness in adaptation of multijoint arm movements to stable and unstable dynamics. *Experimental Brain Research*, 151(2), 145–157. <https://doi.org/10.1007/s00221-003-1443-3>
- Fredsted, A., Clausen, T., & Overgaard, K. (2008). Effects of step exercise on muscle damage and muscle Ca²⁺ content in men and women. *Journal of Strength and Conditioning Research*, 22(4), 1136–1146.
- Freitas, S., Andrade, R., Larcoupaille, L., Mil-homens, P., & Nordez, A. (2015). Muscle and joint responses during and after static stretching performed at different intensities. *European Journal of Applied Physiology*, 115(6), 1263–1272. <https://doi.org/10.1007/s00421-015-3104-1>
- Freitas, S., Vilarinho, D., Vaz, J., Bruno, P., Costa, P., & Mil-homens, P. (2015). Responses to static stretching are dependent on stretch intensity and duration. *Clinical Physiology and Functional Imaging*, 35(6), 478–484. <https://doi.org/10.1111/cpf.12186>
- Friston, K., Williams, S., Howard, R., Frackowiak, R., & Turner, R. (1996). Movement-Related effects in fMRI time-series. *Magnetic Resonance in Medicine*, 35(3), 346–355. <https://doi.org/10.1002/mrm.1910350312>
-

- Froese, E., & Houston, M. (1985). Torque-velocity characteristics and muscle fiber type in human vastus lateralis. *Journal of Applied Physiology*, 59(2), 309–314. Retrieved from <http://jap.physiology.org/content/59/2/309.short>
- Fukunaga, T., Ichinose, Y., Ito, M., Kawakami, Y., & Fukashiro, S. (1997). Determination of fascicle length and pennation in a contracting human muscle in vivo. *Journal of Applied Physiology*, 82(1), 354–358. Retrieved from <http://jap.physiology.org/content/jap/82/1/354.full.pdf>
- Fukunaga, T., Kawakami, Y., Kuno, S., Funato, K., & Fukashiro, S. (1997). Muscle architecture and function in humans. *Journal of Biomechanics*, 30(5), 457–463. [https://doi.org/10.1016/S0021-9290\(96\)00171-6](https://doi.org/10.1016/S0021-9290(96)00171-6)
- Fukunaga, T., Kubo, K., Kawakami, Y., Fukashiro, S., Kanehisa, H., & Maganaris, C. (2001). In vivo behaviour of human muscle tendon during walking. *Proceedings of the Royal Society B: Biological Sciences*, 268(1464), 229–233. <https://doi.org/10.1098/rspb.2000.1361>
- Fulton, A., & Isaacs, W. (1991). Titin, a huge, elastic sarcomeric protein with a probable role in morphogenesis. *Bioessays*, 13(4), 157–161. <https://doi.org/10.1002/bies.950130403>
- Fung, Y. (1993). *Mechanical properties of living tissues*. *Biomechanics* (2nd ed.). New York: Springer.
- Gabriel, R., Abrantes, J., Granata, K., Bulas-Cruz, J., Melo-Pinto, P., & Filipe, V. (2008). Dynamic joint stiffness of the ankle during walking: Gender-related differences. *Physical Therapy in Sport*, 9(1), 16–24. <https://doi.org/10.1016/j.ptsp.2007.08.002>
- Gajdosik, R. (2001). Passive extensibility of skeletal muscle: Review of the literature with clinical implications. *Clinical Biomechanics*, 16(2), 87–101. [https://doi.org/10.1016/S0268-0033\(00\)00061-9](https://doi.org/10.1016/S0268-0033(00)00061-9)
- Gajdosik, R., Vander Linden, D., & Williams, A. (1999). Influence of age on length
-

-
- and passive elastic stiffness characteristics of the calf muscle-tendon unit of women. *Physical Therapy*, 79(9), 827–838. <https://doi.org/10.1093/ptj/79.9.827>
- Gambetta, V. (1997). Stretching the truth. *Training and Conditioning*, 7(2), 25–31.
- Gandevia, S. (2001). Spinal and supraspinal factors in human muscle fatigue. *Physiological Reviews*, 81(4), 1725–1789. <https://doi.org/10.1113/jphysiol.1996.sp021164>
- Gandevia, S., McCloskey, D., & Burke, D. (1992). Kinaesthetic signals and muscle contraction. *Trends in Neurosciences*, 15(2), 62–65. [https://doi.org/10.1016/0166-2236\(92\)90028-7](https://doi.org/10.1016/0166-2236(92)90028-7)
- Gans, C. (1982). Fiber architecture and muscle function. *Exercise and Sport Sciences Reviews*, 10(1), 160–207. <https://doi.org/10.1037/0013248>
- Garber, C., Blissmer, B., Deschenes, M., Franklin, B., Lamonte, M., Lee, I., ... Swain, D. (2011). Quantity and quality of exercise for developing and maintaining cardiorespiratory, musculoskeletal, and neuromotor fitness in apparently healthy adults: Guidance for prescribing exercise. *Medicine and Science in Sports and Exercise*, 43(7), 1334–1359. <https://doi.org/10.1249/MSS.0b013e318213fefb>
- Garrett, W. (1990). Muscle strain injuries: clinical and basic aspects. / Les claquages musculaires: aspects cliniques et fondamentaux. *Medicine and Science in Sports and Exercise*, 22(4), 436–443. <https://doi.org/10.1249/00005768-199008000-00003>
- Garrett, W. (1996). Muscle strain injuries. *The American Journal of Sports Medicine*, 24(6 Suppl), S2-8. [https://doi.org/10.1016/S1440-2440\(99\)80088-7](https://doi.org/10.1016/S1440-2440(99)80088-7)
- Gautel, M., Mues, A., & Young, P. (1999). Control of sarcomeric assembly: The flow of information on titin. In *Reviews of Physiology, Biochemistry and Pharmacology* (pp. 97–137). Berlin, Heidelberg: Springer Berlin Heidelberg. <https://doi.org/10.1007/BFb0119625>
- Gelen, E. (2010). Acute effects of different warm-up methods on sprint, slalom
-

dribbling, and penalty kick performance in soccer players. *Journal of Strength and Conditioning Research*, 24(4), 950–956.

<https://doi.org/10.1519/JSC.0b013e3181cb703f>

Gennisson, J., Catheline, S., Chaffai, S., & Fink, M. (2003). Transient elastography in anisotropic medium: application to the measurement of slow and fast shear wave speeds in muscles. *The Journal of the Acoustical Society of America*, 114(1), 536–541. <https://doi.org/10.1121/1.1579008>

Gennisson, J., Cornu, C., Catheline, S., Fink, M., & Portero, P. (2005). Human muscle hardness assessment during incremental isometric contraction using transient elastography. *Journal of Biomechanics*, 38(7), 1543–1550. <https://doi.org/10.1016/j.jbiomech.2004.07.013>

Gennisson, J., Deffieux, T., Macé, E., Montaldo, G., Fink, M., & Tanter, M. (2010). Viscoelastic and anisotropic mechanical properties of in vivo muscle tissue assessed by supersonic shear imaging. *Ultrasound in Medicine and Biology*, 36(5), 789–801. <https://doi.org/10.1016/j.ultrasmedbio.2010.02.013>

Gill, N., Preece, S., Young, S., & Bramah, C. (2017). Are the arms and head required to accurately estimate centre of mass motion during running? *Gait and Posture*, 51(Supplement C), 281–283. <http://doi.org/10.1016/j.gaitpost.2016.11.001>

Gleeson, N. (2001). Assessment of neuromuscular performance using electromyography. In R. G. Eston & T. Reilly (Eds.), *Kinanthropometry and exercise physiology laboratory manual: Tests, procedures and data* (Vol. 2, pp. 37–63). London: Routledge.

Gleeson, N., Minshull, C., Eston, R., & Bailey, A. (2008). Effects of mode of flexibility conditioning on neuromechanical performance in males. In *XVIIth Congress of the International Society of Electrophysiology and Kinesiology Annual Conference*. Niagara Falls, Ontario, Canada.

Gleim, G., & McHugh, M. (1997). Flexibility and its effects on sports injury and performance. *Sports Medicine*, 24(5), 289–299. <https://doi.org/10.2165/00007256-199724050-00001>

- Gleim, G., & Nicholas, J. (1990). The influence of flexibility on the economy of walking and jogging. *Journal of Orthopaedic Research*, 8(6), 814–823. <https://doi.org/10.1002/jor.1100080606>
- Godges, J., MacRae, H., Longdon, C., Tinberg, C., & Macrae, P. (1989). The effects of two stretching procedures on hip range of motion and gait economy. *Journal of Orthopaedic and Sports Physical Therapy*, 10(9), 350–357. <https://doi.org/10.2519/jospt.1989.10.9.350>
- Godges, J., MacRae, P., & Engelke, K. (1993). Effects of exercise on hip range of motion, trunk muscle performance, and gait economy. *Physical Therapy*, 73(7), 468–477. Retrieved from <http://ptjournal.apta.org/content/73/7/468.short>
- Gollhofer, A., & Rapp, W. (1993). Recovery of stretch reflex responses following mechanical stimulation. *European Journal of Applied Physiology and Occupational Physiology*, 66(5), 415–420. <https://doi.org/10.1007/BF00599614>
- Gordon, A., Huxley, A., & Julian, F. (1966). The variation in isometric tension with sarcomere length in vertebrate muscle fibres. *The Journal of Physiology*, 184(1), 170–192. <https://doi.org/5921536>
- Gottlieb, G., & Agarwal, G. (1979). Response to sudden torques about ankle in man: myotatic reflex. *Journal of Neurophysiology*, 42(1), 91–106. Retrieved from <http://jn.physiology.org/content/42/1/91>
- Goubel, F., & Lensele-Corbeil, G. (2003). *Biomécanique : éléments de mécanique musculaire*. Masson.
- Goulding, D., Bullard, B., & Gautel, M. (1997). A survey of in situ sarcomere extension in mouse skeletal muscle. *Journal of Muscle Research and Cell Motility*, 18(4), 465–472. <https://doi.org/10.1023/A:1018650915751>
- Gourgoulis, V., Aggeloussis, N., Kasimatis, P., Mavromatis, G., & Garas, A. (2003). Effect of a submaximal half-squats warm-up program on vertical jumping ability. *Journal of Strength and Conditioning Research*, 17(2), 342–344. [https://doi.org/10.1519/1533-4287\(2003\)017<0342:eoashw>2.0.co;2](https://doi.org/10.1519/1533-4287(2003)017<0342:eoashw>2.0.co;2)
-

- Gowitzke, B. (1984). Muscles alive in sport. In M. Adrian & H. Deutch (Eds.), *Biomechanics* (pp. 3–19). Eugene, OR: Microform Publications.
- Granata, K., Wilson, S., & Padua, D. (2002). Gender differences in active musculoskeletal stiffness. Part I.: Quantification in controlled measurements of knee joint dynamics. *Journal of Electromyography and Kinesiology*, *12*(2), 119–126. [https://doi.org/10.1016/S1050-6411\(02\)00002-0](https://doi.org/10.1016/S1050-6411(02)00002-0)
- Grange, R., Cory, C., Vandenboom, R., & Houston, M. (1995). Myosin phosphorylation augments force-displacement and force-velocity relationships of mouse fast muscle. *American Journal of Physiology - Cell Physiology*, *269*(3), C713–C724. Retrieved from <http://ajpcell.physiology.org/content/269/3/C713>
- Gregor, R., Edgerton, V., Perrine, J., Champion, D., & DeBus, C. (1979). Torque-velocity relationships and muscle fiber composition in elite female athletes. *Journal of Applied Physiology*, *47*(2), 388–392. Retrieved from <http://jap.physiology.org/content/47/2/388.short>
- Grieve, D., Pheasant, S., & Cavanagh, P. (1978). Prediction of gastrocnemius length from knee and ankle joint posture. *Biomechanics Vi-A*, *2*, 405–412. Retrieved from http://www.myobase.org/index.php?lvl=notice_display&id=16426
- Griffin, L. (2003). Neuromuscular training and injury prevention in sports. *Clinical Orthopaedics and Related Research*, *409*(409), 53–60. <https://doi.org/10.1097/01.blo.0000057788.10364.aa>
- Grigg, P., Schaible, H., & Schmidt, R. (1986). Mechanical sensitivity of group III and IV afferents from posterior articular nerve in normal and inflamed cat knee. *Journal of Neurophysiology*, *55*(4), 635–643. Retrieved from <http://jn.physiology.org/content/jn/55/4/635.full.pdf>
- Grosset, J., Piscione, J., Lambertz, D., & Pérot, C. (2008). Paired changes in electromechanical delay and musculo-tendinous stiffness after endurance or plyometric training. *European Journal of Applied Physiology*, *105*(1), 131–139. <https://doi.org/10.1007/s00421-008-0882-8>
-

- Guglielmo, L., Greco, C., & Denadai, B. (2009). Effects of strength training on running economy. *International Journal of Sports Medicine*, 30(1), 27–32. <https://doi.org/10.1055/s-2008-1038792>
- Guilhem, G., Doguet, V., Hauraix, H., Lacourpaille, L., Jubeau, M., Nordez, A., & Dorel, S. (2016). Muscle force loss and soreness subsequent to maximal eccentric contractions depend on the amount of fascicle strain in vivo. *Acta Physiologica*, 217(2), 152–163. <https://doi.org/10.1111/apha.12654>
- Guissard, N., & Duchateau, J. (2006). Neural aspects of muscle stretching. *Exercise and Sport Sciences Reviews*, 34(4), 154–158. <https://doi.org/10.1249/01.jes.0000240023.30373.eb>
- Güllich, A., & Schmidtbleicher, D. (1996). MVC-induced short-term potentiation of explosive force. *New Studies in Athletics*, 11(4), 67–84.
- Guzzetta, A., Staudt, M., Petacchi, E., Ehlers, J., Erb, M., Wilke, M., ... Cioni, G. (2007). Brain representation of active and passive hand movements in children. *Pediatric Research*, 61(4), 485–490. <https://doi.org/10.1203/pdr.0b013e3180332c2e>
- Haddad, M., Dridi, A., Chtara, M., Chaouachi, A., Wong, D., Behm, D., & Chamari, K. (2014). Static Stretching Can Impair Explosive Performance for At Least 24 Hours. *Journal of Strength and Conditioning Research*, 28(1), 140–146. <https://doi.org/10.1519/JSC.0b013e3182964836>
- Haff, G., & Triplett, N. (2016). *Essentials of strength training and conditioning* (4th ed.). Champaign, IL: Human Kinetics.
- Hajnal, J., Myers, R., Oatridge, A., Schwieso, J., Young, I., & Bydder, G. (1994). Artifacts due to stimulus correlated motion in functional imaging of the brain. *Magnetic Resonance in Medicine*, 31(3), 283–291. <https://doi.org/10.1002/mrm.1910310307>
- Halbertsma, J., & Göeken, L. (1994). Stretching exercises: effect on passive extensibility and stiffness in short hamstrings of healthy subjects. *Archives of*
-

Physical Medicine and Rehabilitation, 75(9), 976–981.

<https://doi.org/10.1016/j.pmrj.2009.04.009>

Halbertsma, J., Mulder, I., Göeken, L., & Eisma, W. (1999). Repeated passive stretching: Acute effect on the passive muscle moment and extensibility of short hamstrings. *Archives of Physical Medicine and Rehabilitation*, 80(4), 407–414. [https://doi.org/10.1016/S0003-9993\(99\)90277-0](https://doi.org/10.1016/S0003-9993(99)90277-0)

Halbertsma, J., Van Bolhuis, A., & Göeken, L. (1996). Sport stretching: Effect on passive muscle stiffness of short hamstrings. *Archives of Physical Medicine and Rehabilitation*, 77(7), 688–692. [https://doi.org/10.1016/S0003-9993\(96\)90009-X](https://doi.org/10.1016/S0003-9993(96)90009-X)

Hamada, T., Sale, D., MacDougall, J., & Tarnopolsky, M. (2000). Postactivation potentiation, fiber type, and twitch contraction time in human knee extensor muscles. *Journal of Applied Physiology*, 88(6), 2131–2137. Retrieved from <http://jap.physiology.org/content/88/6/2131>

Hamill, J., Knutzen, K., & Derrick, T. (2015). *Biomechanical basis of human movement* (4th ed.). Philadelphia, PA: Lippincott Williams & Wilkins. <https://doi.org/10.1017/CBO9781107415324.004>

Hamner, S., Seth, A., & Delp, S. (2010). Muscle contributions to propulsion and support during running. *Journal of Biomechanics*, 43(14), 2709–2716. <http://doi.org/10.1016/j.jbiomech.2010.06.025>

Hardy, L. (1985). Improving active range of hip flexion. *Research Quarterly for Exercise and Sport*, 56(2), 111–114. <https://doi.org/10.1080/02701367.1985.10608444>

Hartig, D., & Henderson, J. (1999). Increasing hamstring flexibility decreases lower extremity overuse injuries in military basic trainees. *The American Journal of Sports Medicine*, 27(2), 173–176. <https://doi.org/10.1177/03635465990270021001>

Harvey, L., Byak, A., Ostrovskaya, M., Glinsky, J., Katte, L., & Herbert, R. (2003). Randomised trial of the effects of four weeks of daily stretch on extensibility of

-
- hamstring muscles in people with spinal cord injuries. *Australian Journal of Physiotherapy*, 49(3), 176–181. [https://doi.org/10.1016/S0004-9514\(14\)60237-3](https://doi.org/10.1016/S0004-9514(14)60237-3)
- Havsteen, I., Ohlhues, A., Madsen, K., Nybing, J., Christensen, H., & Christensen, A. (2017). Are movement artifacts in magnetic resonance imaging a real problem?—A narrative review. *Frontiers in Neurology*, 8, 232. <https://doi.org/10.3389/fneur.2017.00232>
- Hayes, P., & Walker, A. (2007). Pre-exercise stretching does not impact upon running economy. *Journal of Strength and Conditioning Research*, 21(4), 1227–1232. <https://doi.org/10.1519/R-19545.1>
- He, Z., Bottinelli, R., Pellegrino, M., Ferenczi, M., & Reggiani, C. (2000). ATP consumption and efficiency of human single muscle fibers with different myosin isoform composition. *Biophysical Journal*, 79(2), 945–961. [https://doi.org/10.1016/S0006-3495\(00\)76349-1](https://doi.org/10.1016/S0006-3495(00)76349-1)
- Hedrick, A. (2000). Dynamic flexibility training. *Strength and Conditioning Journal*, 22, 33–38.
- Heise, G., Shinohara, M., & Binks, L. (2008). Biarticular leg muscles and links to running economy. *International Journal of Sports Medicine*, 29(8), 688–691. <https://doi.org/10.1055/s-2007-989372>
- Henriksson-Larsen, K., Wretling, M., Lorentzon, R., & Öberg, L. (1992). Do muscle fibre size and fibre angulation correlate in pennated human muscles? *European Journal of Applied Physiology and Occupational Physiology*, 64(1), 68–72. <https://doi.org/10.1007/BF00376443>
- Herbert, R., & Gandevia, S. (1995). Changes in pennation with joint angle and muscle torque: in vivo measurements in human brachialis muscle. *The Journal of Physiology*, 484(Pt2), 523–532. <https://doi.org/10.1113/jphysiol.1995.sp020683>
- Herbert, R., Moseley, A., Butler, J., & Gandevia, S. (2002). Change in length of relaxed muscle fascicles and tendons with knee and ankle movement in
-

humans. *The Journal of Physiology*, 539(Pt 2), 637–645.

<https://doi.org/10.1113/jphysiol.2001.012756>

Herda, T., Cramer, J., Ryan, E., Eric, D., McHugh, M., & Stout, J. (2008). Acute effects of static versus dynamic stretching on isometric peak torque, electromyography, and mechanomyography of the biceps femoris muscle. *Journal of Strength and Conditioning Research*, 22(3), 809–817.

<https://doi.org/10.1519/JSC.0b013e31816a82ec>

Herda, T., Herda, N., Costa, P., Walter-Herda, A., Valdez, A., & Cramer, J. (2013). The effects of dynamic stretching on the passive properties of the muscle-tendon unit. *Journal of Sports Sciences*, 31(5), 479–487.

<https://doi.org/10.1080/02640414.2012.736632>

Hermens, H., Freriks, B., Merletti, R., Stegeman, D., Blok, J., Rau, G., ... Hägg, G. (1999). *European recommendations for surface electromyography: Results of the SENIAM project. Roessingh Research and Development*.

[https://doi.org/10.1016/S1050-6411\(00\)00027-4](https://doi.org/10.1016/S1050-6411(00)00027-4)

Hertling, D., & Kessler, R. (2006). *Management of common musculoskeletal disorders: Physical therapy principles and methods*. Lippincott Williams & Wilkins.

Hewett, T., Lindenfeld, T., Riccobene, J., & Noyes, F. (1999). The effect of neuromuscular training on the incidence of knee injury in female athletes. A prospective study. *The American Journal of Sports Medicine*, 27(6), 699–706.

<https://doi.org/doi.org/10.1177/03635465990270060301>

Hill, A. (1938). The heat of shortening and the dynamic constants of muscle. *Proceedings of the Royal Society B: Biological Sciences*, 126(843), 136–195.

<https://doi.org/10.1098/rspb.1938.0050>

Hirata, K., Miyamoto-Mikami, E., Kanehisa, H., & Miyamoto, N. (2016). Muscle-specific acute changes in passive stiffness of human triceps surae after stretching. *European Journal of Applied Physiology*, 116(5), 911–918.

<https://doi.org/10.1007/s00421-016-3349-3>

Hoang, P., Gorman, R., Todd, G., Gandevia, S., & Herbert, R. (2005). A new method for measuring passive length-tension properties of human gastrocnemius muscle in vivo. *Journal of Biomechanics*, *38*(6), 1333–1341.

<https://doi.org/10.1016/j.jbiomech.2004.05.046>

Hodgson, M., Docherty, D., & Robbins, D. (2005). Post-activation potentiation.

Sports Medicine, *35*(7), 585–595. <https://doi.org/10.2165/00007256-200535070-00004>

Hof, A., Elzinga, H., Grimmius, W., & Halbertsma, J. (2002). Speed dependence of averaged EMG profiles in walking. *Gait and Posture*, *16*(1), 78–86.

[https://doi.org/10.1016/S0966-6362\(01\)00206-5](https://doi.org/10.1016/S0966-6362(01)00206-5)

Hoge, K., Ryan, E., Costa, P., Herda, T., Walter, A., Stout, J., & Cramer, J. (2010). Gender differences in musculotendinous stiffness and range of motion after an acute bout of stretching. *Journal of Strength and Conditioning Research*, *24*(10), 2618–2626. <https://doi.org/10.1519/JSC.0b013e3181e73974>

Holt, B., & Lambourne, K. (2008). The impact of different warm-up protocols on vertical jump performance in male collegiate athletes. *Journal of Strength and Conditioning Research*, *22*(1), 226–229.

<https://doi.org/10.1519/JSC.0b013e31815f9d6a>

Hopkins, W. (2000). Measures of reliability in sports medicine and science. *Sports Medicine*, *30*(1), 1–15. <https://doi.org/10.2165/00007256-200030010-00001>

Hopkins, W. (2002). New view of statistics: Effect magnitudes. *Sportscience*. Retrieved from <http://www.sportsci.org/resource/stats/effectmag.html>

Hopkins, W. (2004). How to interpret changes in an athletic performance test.

Sportscience, *8*, 1–7. Retrieved from

<http://axne.sportsci.org/jour/04/wghtests.htm>

- Hopkins, W. (2006). Spreadsheets for analysis of controlled trials, with adjustment for a subject characteristic. *Sportscience*, 10, 46–50. Retrieved from <http://sportsci.org/2006/wghcontrial.htm>
- Hopkins, W. (2007). A spreadsheet for deriving a confidence interval, mechanistic inference and clinical inference from a p value. *Sportscience*, 11, 16–20. Retrieved from www.sportsci.org
- Hopkins, W. (2015). Spreadsheets for analysis of validity and reliability. *Sportscience*, 19, 36–42. Retrieved from <http://www.sportsci.org/2015/ValidRely.htm>
- Hopkins, W., Marshall, S., Batterham, A., & Hanin, J. (2009). Progressive statistics for studies in sports medicine and exercise science. *Medicine and Science in Sports and Exercise*, 41(1), 3–12. <https://doi.org/10.1249/MSS.0b013e31818cb278>
- Hoppeler, H., & Billeter, R. (2003). Structure and function of skeletal muscle | Struktur und funktion der skelettmuskulatur. *Therapeutische Umschau*, 60(7), 363–370. <https://doi.org/10.1024/0040-5930.60.7.363>
- Horowitz, R. (1992). Passive force generation and titin isoforms in mammalian skeletal muscle. *Biophysical Journal*, 61(2), 392–398. [https://doi.org/10.1016/S0006-3495\(92\)81845-3](https://doi.org/10.1016/S0006-3495(92)81845-3)
- Horowitz, R. (1999). The physiological role of titin in striated muscle. In *Reviews of Physiology, Biochemistry and Pharmacology* (pp. 57–96). Berlin, Heidelberg: Springer Berlin Heidelberg. <https://doi.org/10.1007/BFb0119624>
- Horowitz, R., & Podolsky, R. (1987). The positional stability of thick filaments in activated skeletal muscle depends on sarcomere length: Evidence for the role of titin filaments. *Journal of Cell Biology*, 105(5), 2217–2223. <https://doi.org/10.1083/jcb.105.5.2217>
- Hough, P., Ross, E., & Howatson, G. (2009). Effects of dynamic and static stretching on vertical jump performance and electromyographic activity. *Journal of*
-

Strength and Conditioning Research, 23(2), 507–512.

<https://doi.org/10.1519/JSC.0b013e31818cc65d>

Houk, J. (1991). Outline for a theory of motor learning. In *Tutorials in Motor Neuroscience* (pp. 253–268). Dordrecht: Springer Netherlands.

https://doi.org/10.1007/978-94-011-3626-6_21

Howell, J., Chleboun, G., & Conatser, R. (1993). Muscle stiffness, strength loss, swelling and soreness following exercise-induced injury in humans. *The Journal of Physiology*, 464, 183–96. <https://doi.org/10.1113/jphysiol.1993.sp019629>

Huijng, P. (1992). Elastic potential of muscle. In P. V Komi (Ed.), *Strength and Power in Sport* (pp. 151–168). Oxford, UK: Blackwell Science.

Hultborn, H., Jankowska, E., & Lindström, S. (1971). Recurrent inhibition of interneurons monosynaptically activated from group Ia afferents. *The Journal of Physiology*, 215(3), 613–636. <https://doi.org/10.1113/jphysiol.1971.sp009488>

Hunter, G., Katsoulis, K., McCarthy, J., Ogard, W., Bamman, M., Wood, D., ... Newcomer, B. (2011). Tendon length and joint flexibility are related to running economy. *Medicine and Science in Sports and Exercise*, 43(8), 1492–1499. <https://doi.org/10.1249/MSS.0b013e318210464a>

Hutton, R. (1992). Neuromuscular basis of stretching exercises. In P. V. Komi (Ed.), *Strength and Power in Sport. The encyclopaedia of Sports Medicine* (pp. 29–38). Oxford, UK: Blackwell Scientific.

Huxley, A., & Niedergerke, R. (1954). Structural changes in muscle during contraction; interference microscopy of living muscle fibres. *Nature*, 173(4412), 971–973. <https://doi.org/10.1038/173971a0>

Huxley, H. (1967). Recent X-ray diffraction and electron microscope studies of striated muscle. *The Journal of General Physiology*, 50(6), Suppl:71-83. <https://doi.org/10.1085/jgp.50.6.71>

Huxley, H., & Hanson, J. (1954). Changes in the Cross-Striations of Muscle during Contraction and Stretch and their Structural interpretation. *Nature*, 173(4412),

973–976. <https://doi.org/10.1038/173973a0>

- Hyman, J., & Rodeo, S. (2000). Injury and repair of tendons and ligaments. *Physical Medicine and Rehabilitation Clinics of North America*, 11(2), 267–288.
- Iaizzo, P., & Poppele, R. (1990). Twitch relaxation of the cat soleus muscle at different lengths and temperatures. *Muscle and Nerve*, 13(12), 1105–1112. <https://doi.org/10.1002/mus.880131204>
- IASP Taxonomy Working Group. (2012). Classification of Chronic Pain. Retrieved September 13, 2017, from <https://www.iasp-pain.org/Taxonomy>
- Ichinose, Y., Kawakami, Y., & Fukunaga, T. (1995). In vivo measurement of fascicle arrangement of human vastus lateralis muscle using ultrasound. In *XVth Congress of the International Society of Biomechanics* (pp. 412–413).
- Isabelle, M., Sylvie, Q., & Chantal, P. (2003). Electromechanical assessment of ankle stability. *European Journal of Applied Physiology*, 88(6), 558–564. <https://doi.org/10.1007/s00421-002-0748-4>
- Jackson, A., Beard, E., Wier, L., Ross, R., Stuteville, J., & Blair, S. (1995). Changes in aerobic power of men, ages 25-70 yr. *Medicine and Science in Sports and Exercise*, 27(1), 113–120. <https://doi.org/10.1249/00005768-199501000-00020>
- Jaggers, J., Swank, A., Frost, K., & Lee, C. (2008). The acute effects of dynamic and ballistic stretching on vertical jump height, force, and power. *Journal of Strength and Conditioning Research*, 22(6), 1844–1849. <https://doi.org/10.1519/JSC.0b013e3181854a3d>
- Jami, L. (1992). Golgi tendon organs in mammalian skeletal muscle: functional properties and central actions. *Physiological Reviews*, 72(3), 623–666. Retrieved from <http://physrev.physiology.org/content/72/3/623.long>
- Järvinen, T., Järvinen, T., Kannus, P., Józsa, L., & Järvinen, M. (2004). Collagen fibres of the spontaneously ruptured human tendons display decreased thickness and crimp angle. *Journal of Orthopaedic Research*, 22(6), 1303–1309.
-

<https://doi.org/10.1016/j.orthres.2004.04.003>

- Jelvéus, A. (2011). Soft tissue stretching in sports massage. In A. Jelvéus (Ed.), *Integrated Sports Massage Therapy* (pp. 75–95). Edinburgh: Churchill Livingstone. <https://doi.org/10.1016/B978-0-443-10126-7.00006-X>
- Johnson, M., Polgar, J., Weightman, D., & Appleton, D. (1973). Data on the distribution of fibre types in thirty-six human muscles. An autopsy study. *Journal of the Neurological Sciences*, 18(1), 111–129. [https://doi.org/10.1016/0022-510X\(73\)90023-3](https://doi.org/10.1016/0022-510X(73)90023-3)
- Johnson, R., Quinn, T., Kertzer, R., & Vroman, N. (1997). Strength training in female distance runners: impact on running economy. *Journal of Strength and Conditioning Research*, 11(4), 224–229. [https://doi.org/10.1519/1533-4287\(1997\)011<0224:stifdr>2.3.co;2](https://doi.org/10.1519/1533-4287(1997)011<0224:stifdr>2.3.co;2)
- Jones, A. (2002). Running economy is negatively related to sit-and-reach test performance in international-standard distance runners. *International Journal of Sports Medicine*, 23(1), 40–43. <https://doi.org/10.1055/s-2002-19271>
- Joyner, M., & Coyle, E. (2008). Endurance exercise performance: the physiology of champions. *The Journal of Physiology*, 586(1), 35–44. <https://doi.org/10.1113/jphysiol.2007.143834>
- Józsa, L., & Kannus, P. (2007). Histopathological findings in spontaneous tendon ruptures. *Scandinavian Journal of Medicine and Science in Sports*, 7(2), 113–118. <https://doi.org/10.1111/j.1600-0838.1997.tb00127.x>
- Jung, A. (2003). The impact of resistance training on distance running performance. *Sports Medicine*. <https://doi.org/10.2165/00007256-200333070-00005>
- Kafka, V., Jírová, J., & Smetana, V. (1995). On the mechanical function of tendon. *Clinical Biomechanics*, 10(1), 50–56. [https://doi.org/10.1016/0268-0033\(95\)90437-E](https://doi.org/10.1016/0268-0033(95)90437-E)
- Kallenberg, L., Schulte, E., Disselhorst-Klug, C., & Hermens, H. (2007). Myoelectric
-

manifestations of fatigue at low contraction levels in subjects with and without chronic pain. *Journal of Electromyography and Kinesiology*, 17(3), 264–274. <https://doi.org/10.1016/j.jelekin.2006.04.004>

Kallerud, H., & Gleeson, N. (2013). Effects of stretching on performances involving stretch-shortening cycles. *Sports Medicine*, 43(8), 733–750. <https://doi.org/10.1007/s40279-013-0053-x>

Kandel, E., Schwartz, J., & Jessell, T. (2000). *Principles of neural science* (4th ed.). New York: McGraw-Hill.

Kanehisa, H., Nagareda, H., Kawakami, Y., Akima, H., Masani, K., Kouzaki, M., & Fukunaga, T. (2002). Effects of equivolume isometric training programs comprising medium or high resistance on muscle size and strength. *European Journal of Applied Physiology*, 87(2), 112–119. <https://doi.org/10.1007/s00421-002-0604-6>

Kaneko, M. (1990). Mechanics and energetics in running with special reference to efficiency. *Journal of Biomechanics*, 23(SUPPL. 1), 57–63. [https://doi.org/10.1016/0021-9290\(90\)90041-Z](https://doi.org/10.1016/0021-9290(90)90041-Z)

Kannus, P. (2000). Structure of the tendon connective tissue. *Scandinavian Journal of Medicine and Science in Sports*, 10(6), 312–320. <https://doi.org/10.1034/j.1600-0838.2000.010006312.x>

Kastelic, J., Galeski, A., & Baer, E. (1978). The multicomposite structure of tendon. *Connective Tissue Research*, 6(1), 11–23. <https://doi.org/10.3109/03008207809152283>

Katch, V., McArdle, W., & Katch, F. (2011). *Essentials of exercise physiology* (4th ed.). Baltimore: Lippincott Williams & Wilkins. <https://doi.org/10.1007/s13398-014-0173-7.2>

Kato, E., Kanehisa, H., Fukunaga, T., & Kawakami, Y. (2010). Changes in ankle joint stiffness due to stretching: The role of tendon elongation of the gastrocnemius

-
- muscle. *European Journal of Sport Science*, 10(2), 111–119.
<https://doi.org/10.1080/17461390903307834>
- Kato, E., Vieillevoye, S., Balestra, C., Guissard, N., & Duchateau, J. (2011). Acute effect of muscle stretching on the steadiness of sustained submaximal contractions of the plantar flexor muscles. *Journal of Applied Physiology*, 110(2), 407–415. <https://doi.org/10.1152/jappphysiol.01087.2010>
- Kawakami, Y., Abe, T., & Fukunaga, T. (1993). Muscle-fiber pennation angles are greater in hypertrophied than in normal muscles. *Journal of Applied Physiology*, 74(6), 2740–2744. <https://doi.org/10.1017/s0007114507617206>
- Kawakami, Y., Abe, T., Kuno, S., & Fukunaga, T. (1995). Training-induced changes in muscle architecture and specific tension. *European Journal of Applied Physiology and Occupational Physiology*, 72(1–2), 37–43.
<https://doi.org/10.1007/BF00964112>
- Kawakami, Y., Ichinose, Y., & Fukunaga, T. (1998). Architectural and functional features of human triceps surae muscles during contraction. *Journal of Applied Physiology*, 85(2), 398–404.
- Kawakami, Y., Muraoka, T., Ito, S., Kanehisa, H., & Fukunaga, T. (2002). In vivo muscle fibre behaviour during counter-movement exercise in humans reveals a significant role for tendon elasticity. *The Journal of Physiology*, 540(2), 635–646.
<https://doi.org/10.1113/jphysiol.2001.013459>
- Kawakami, Y., Nakazawa, K., Fujimoto, T., Nozaki, D., Miyashita, M., & Fukunaga, T. (1994). Specific tension of elbow flexor and extensor muscles based on magnetic resonance imaging. *European Journal of Applied Physiology and Occupational Physiology*, 68(2), 139–147. <https://doi.org/10.1007/BF00244027>
- Kay, A., & Blazeovich, A. (2008). Reductions in active plantarflexor moment are significantly correlated with static stretch duration. *European Journal of Sport Science*, 8(1), 41–46. <https://doi.org/10.1080/17461390701855505>
-

- Kay, A., & Blazevich, A. (2009). Moderate-duration static stretch reduces active and passive plantar flexor moment but not Achilles tendon stiffness or active muscle length. *Journal of Applied Physiology*, *106*(4), 1249–1256.
<https://doi.org/10.1152/jappphysiol.91476.2008>
- Kay, A., & Blazevich, A. (2012). Effect of acute static stretch on maximal muscle performance: A systematic review. *Medicine and Science in Sports and Exercise*, *44*(1), 154–164. <https://doi.org/10.1249/MSS.0b013e318225cb27>
- Kay, A., Husbands-Beasley, J., & Blazevich, A. (2015). Effects of PNF, static stretch, and isometric contractions on muscle–tendon mechanics. *Medicine and Science in Sports and Exercise*, *47*(10), 2181–2190.
<https://doi.org/10.1249/MSS.0000000000000632>
- Kay, A., Richmond, D., Talbot, C., Mina, M., Baross, A., & Blazevich, A. (2016). stretching of active muscle elicits chronic changes in multiple strain risk factors. *Medicine and Science in Sports and Exercise*, *48*(7), 1388–1396.
<https://doi.org/10.1249/MSS.0000000000000887>
- Kearney, R., Lortie, M., & Stein, R. (1999). Modulation of stretch reflexes during imposed walking movements of the human ankle. *Journal of Neurophysiology*, *81*(6), 2893–2902. Retrieved from
<http://jn.physiology.org/content/81/6/2893.short>
- Ker, R. (2007). Mechanics of tendon, from an engineering perspective. *International Journal of Fatigue*, *29*(6), 1001–1009.
<https://doi.org/10.1016/j.ijfatigue.2006.09.020>
- Ker, R., Bennett, M., Bibby, S., Kester, R., & Alexander, R. (1987). The spring in the arch of the human foot. *Nature*, *325*(7000), 147–149.
<https://doi.org/10.1038/325147a0>
- Khan, S., & Burne, J. (2009). Afferents contributing to autogenic inhibition of gastrocnemius following electrical stimulation of its tendon. *Brain Research*, *1282*, 28–37. <https://doi.org/10.1016/j.brainres.2009.04.048>
-

- Kibler, W., Goldberg, C., & Chandler, T. (1991). Functional biomechanical deficits in running athletes with plantar fasciitis. *The American Journal of Sports Medicine*, 19(1), 66–71. <https://doi.org/10.1177/036354659101900111>
- Klee, A., & Wiemann, K. (2002). Stretch and contraction specific changes in passive torque in human M. rectus femoris. *European Journal of Sport Science*, 2(6), 1–10. <https://doi.org/10.1080/17461391.2002.10142576>
- Knott, M., & Voss, D. (1956). *Proprioceptive neuromuscular facilitation*. New York: Paul B. Hoeber Inc.
- Kokkonen, J., Nelson, A., & Cornwell, A. (1998). Acute muscle stretching inhibits maximal strength performance. *Research Quarterly for Exercise and Sport*, 69(4), 411–415. <https://doi.org/10.1080/02701367.1998.10607716>
- Kolber, M., & Zepeda, J. (2004). Addressing hamstring flexibility in athletes with lower back pain: A discussion of commonly prescribed stretching exercises. *Strength and Conditioning Journal*, 26(1), 18–23. [https://doi.org/10.1519/1533-4295\(2004\)026<0018:AHFIAW>2.0.CO;2](https://doi.org/10.1519/1533-4295(2004)026<0018:AHFIAW>2.0.CO;2)
- Koltyn, K. (2000). Analgesia following exercise: a review. *Sports Medicine*, 29(2), 85–98. <https://doi.org/10.1097/SPV.0b013e3181907870>
- Komi, P. (1984). Physiological and biomechanical correlates of muscle function: effects of muscle structure and stretch-shortening cycle on force and speed. *Exercise and Sport Sciences Reviews*, 12, 81–121. Retrieved from http://journals.lww.com/acsm-essr/Citation/1984/01000/Physiological_and_Biomechanical_Correlates_of.6.aspx
- Komi, P. (1986). Training of muscle strength and power: interaction of neuromotoric, hypertrophic, and mechanical factors. *International Journal of Sports Medicine*, 7(S 1), 10–15. <https://doi.org/10.1055/s-2008-1025796>
- Komi, P. (2000). Stretch-shortening cycle: A powerful model to study normal and fatigued muscle. *Journal of Biomechanics*, 33(10), 1197–1206.
-

[https://doi.org/10.1016/S0021-9290\(00\)00064-6](https://doi.org/10.1016/S0021-9290(00)00064-6)

- Konrad, A., Stafilidis, S., & Tilp, M. (2017). Effects of acute static, ballistic, and PNF stretching exercise on the muscle and tendon tissue properties. *Scandinavian Journal of Medicine and Science in Sports*, 27(10), 1070–1080.
<https://doi.org/10.1111/sms.12725>
- Koo, T., Guo, J., Cohen, J., & Parker, K. (2013). Relationship between shear elastic modulus and passive muscle force: An ex-vivo study. *Journal of Biomechanics*, 46(12), 2053–2059. <https://doi.org/10.1016/j.jbiomech.2013.05.016>
- Koo, T., Guo, J., Cohen, J., & Parker, K. (2014). Quantifying the passive stretching response of human tibialis anterior muscle using shear wave elastography. *Clinical Biomechanics*, 29(1), 33–39.
<https://doi.org/10.1016/j.clinbiomech.2013.11.009>
- Kot, B., Zhang, Z., Lee, A., Leung, V., & Fu, S. (2012). Elastic modulus of muscle and tendon with shear wave ultrasound elastography: variations with different technical settings. *PloS ONE*, 7(8), e44348.
<https://doi.org/10.1371/journal.pone.0044348>
- Koziris, L. (Perry). (2015). Preperformance dynamic flexibility exercises: Might be a stretch. *Strength and Conditioning Journal*, 37(1), 74–75.
<https://doi.org/10.1519/SSC.0000000000000119>
- Kruse, N., Barr, M., Gilders, R., Kushnick, M., & Rana, S. (2013). Using a practical approach for determining the most effective stretching strategy in female college division I volleyball players. *Journal of Strength and Conditioning Research*, 27(11), 3060–3067. <https://doi.org/10.1519/JSC.0b013e31828bf2b6>
- Kruse, N., Barr, M., Gilders, R., Kushnick, M., & Rana, S. (2015). Effect of different stretching strategies on the kinetics of vertical jumping in female volleyball athletes. *Journal of Sport and Health Science*, 4(4), 364–370.
<https://doi.org/https://doi.org/10.1016/j.jschs.2014.06.003>
- Kubo, K., Kanehisa, H., & Fukunaga, T. (2002a). Effect of stretching training on the
-

viscoelastic properties of human tendon structures in vivo. *Journal of Applied Physiology*, 92(2), 595–601. <http://doi.org/10.1152/jappphysiol.00658.2001>

Kubo, K., Kanehisa, H., & Fukunaga, T. (2002b). Effects of resistance and stretching training programmes on the viscoelastic properties of human tendon structures in vivo. *The Journal of Physiology*, 538(1), 219–226. <https://doi.org/10.1013/jphysiol.2001.012703>

Kubo, K., Kanehisa, H., & Fukunaga, T. (2002c). Effects of transient muscle contractions and stretching on the tendon structures in vivo. *Acta Physiologica Scandinavica*, 175(2), 157–164. <https://doi.org/10.1046/j.1365-201X.2002.00976.x>

Kubo, K., Kanehisa, H., Kawakami, Y., & Fukunaga, T. (2000). Elastic properties of muscle-tendon complex in long-distance runners. *European Journal of Applied Physiology*, 81(3), 181–187. <https://doi.org/10.1007/s004210050028>

Kubo, K., Kanehisa, H., Kawakami, Y., & Fukunaga, T. (2001a). Effects of repeated muscle contractions on the tendon structures in humans. *European Journal of Applied Physiology*, 84(1), 162–166. <https://doi.org/10.1007/s004210000337>

Kubo, K., Kanehisa, H., Kawakami, Y., & Fukunaga, T. (2001b). Influence of static stretching on viscoelastic properties of human tendon structures in vivo. *Journal of Applied Physiology*, 90(2), 520–527. Retrieved from <http://jap.physiology.org/content/90/2/520.short>

Kubo, K., Kanehisa, H., Kawakami, Y., & Fukunaga, T. (2001c). Influences of repetitive muscle contractions with different modes on tendon elasticity in vivo. *Journal of Applied Physiology*, 91(1), 277–282. <https://doi.org/11408441>

Kubo, K., Miyamoto, M., Tanaka, S., Maki, A., Tsunoda, N., & Kanehisa, H. (2009). Muscle and tendon properties during menstrual cycle. *International Journal of Sports Medicine*, 30(2), 139–143. <https://doi.org/10.1055/s-0028-1104573>

Kubo, K., Miyazaki, D., Shimoju, S., & Tsunoda, N. (2015). Relationship between

elastic properties of tendon structures and performance in long distance runners. *European Journal of Applied Physiology*, 115(8), 1725–1733.

<https://doi.org/10.1007/s00421-015-3156-2>

Kubo, K., Miyazaki, D., Yamada, K., Yata, H., Shimoju, S., & Tsunoda, N. (2015). Passive and active muscle stiffness in plantar flexors of long distance runners. *Journal of Biomechanics*, 48(10), 1937–1943.

<https://doi.org/10.1016/j.jbiomech.2015.04.012>

Kubo, K., Morimoto, M., Komuro, T., Yata, H., Tsunoda, N., Kanehisa, H., & Fukunaga, T. (2007). Effects of plyometric and weight training on muscle-tendon complex and jump performance. *Medicine and Science in Sports and Exercise*, 39(10), 1801–1810. <http://doi.org/10.1249/mss.0b013e31813e630a>

Kubo, K., Ohgo, K., Takeishi, R., Yoshinaga, K., Tsunoda, N., Kanehisa, H., & Fukunaga, T. (2006). Effects of isometric training at different knee angles on the muscle–tendon complex in vivo. *Scandinavian Journal of Medicine and Science in Sports*, 16(3), 159–167. <http://doi.org/10.1111/j.1600-0838.2005.00450.x>

Kubo, K., Tabata, T., Ikebukuro, T., Igarashi, K., & Tsunoda, N. (2010). A longitudinal assessment of running economy and tendon properties in long-distance runners. *Journal of Strength and Conditioning Research*, 24(7), 1724–1731. <https://doi.org/10.1519/JSC.0b013e3181ddf847>

Kubo, K., Tabata, T., Ikebukuro, T., Igarashi, K., Yata, H., & Tsunoda, N. (2010). Effects of mechanical properties of muscle and tendon on performance in long distance runners. *European Journal of Applied Physiology*, 110(3), 507–514. <https://doi.org/10.1007/s00421-010-1528-1>

Kuitunen, S., Komi, P., & Kyröläinen, H. (2002). Knee and ankle joint stiffness in sprint running. *Medicine and Science in Sports and Exercise*, 34(1), 166–173. <https://doi.org/0195-9131/02/3401-0166>

- Kumagai, K., Abe, T., Brechue, W., Ryushi, T., Takano, S., & Mizuno, M. (2000). Sprint performance is related to muscle fascicle length in male 100-m sprinters. *Journal of Applied Physiology*, *88*(3), 811–816.
<https://doi.org/10.1097/00005768-199905001-01648>
- Kurihara, T., Oda, T., Chino, K., Kanehisa, H., Fukunaga, T., Kawakami, Y., & Kurihara, T. (2005). Use of three-dimensional ultrasonography for the analysis of the fascicle length of human gastrocnemius muscle during contractions. *International Journal of Sport and Health Science*, *3*(Special Issue), 226–234.
<https://doi.org/10.5432/ijshs.3.226>
- Kurz, T. (2003). *Stretching scientifically: A guide to flexibility training* (4th ed.). Island Pond, VT: Stadion Publishing Company, Inc.
- Kyröläinen, H., Belli, A., & Komi, P. (2001). Biomechanical factors affecting running economy. *Medicine and Science in Sports and Exercise*, *33*(8), 1330–1337.
<https://doi.org/10.1097/00005768-200108000-00014>
- Kyröläinen, H., & Komi, P. (1994). Neuromuscular performance of lower limbs during voluntary and reflex activity in power- and endurance-trained athletes. *European Journal of Applied Physiology*, *69*(3), 233–239.
<https://doi.org/10.1007/bf01094794>
- Kyröläinen, H., Koskinen, S., McBride, J., Andersen, J., Takala, T., Sipilä, S., & Komi, P. (2003). Interrelationships between muscle structure, muscle strength, and running economy. *Medicine and Science in Sports and Exercise*, *35*(1), 45–49. <https://doi.org/10.1249/01.MSS.0000046149.03322.BB>
- Lacourpaille, L., Hug, F., Bouillard, K., Hogrel, J., & Nordez, A. (2012). Supersonic shear imaging provides a reliable measurement of resting muscle shear elastic modulus. *Physiological Measurement*, *33*(3), N19–N28.
<https://doi.org/10.1088/0967-3334/33/3/N19>
- Lacourpaille, L., Nordez, A., Hug, F., Couturier, A., Dibie, C., & Guilhem, G. (2014). Time-course effect of exercise-induced muscle damage on localized muscle
-

-
- mechanical properties assessed using elastography. *Acta Physiologica*, 211(1), 135–146. <https://doi.org/10.1111/apha.12272>
- Lamb, G., Junankar, P., & Stephenson, D. (1995). Raised intracellular [Ca²⁺] abolishes excitation-contraction coupling in skeletal muscle fibres of rat and toad. *The Journal of Physiology*, 489(2), 349–362. <https://doi.org/10.1113/jphysiol.1995.sp021056>
- Lamontagne, A., Malouin, F., & Richards, C. (2000). Contribution of passive stiffness to ankle plantarflexor moment during gait after stroke. *Archives of Physical Medicine and Rehabilitation*, 81(3), 351–358. <https://doi.org/10.1053/apmr.2000.0810351>
- Landis, J., & Koch, G. (1977). The measurement of observer agreement for categorical data. *Biometrics*, 33(1), 159–174. <https://doi.org/10.2307/2529310>
- Langevin, H., & Huijing, P. (2008). Communicating about fascia: History, pitfalls, and recommendations. *International Journal of Therapeutic Massage and Bodywork*, 2(4), 3–8. Retrieved from <http://ijtmb.org/index.php/ijtmb/article/view/63/83>
- Laporte, Y., & Lloyd, D. (1952). Nature and significance of the reflex connections established by large afferent fibers of muscular origin. *American Journal of Physiology*, 169(3), 609–621. Retrieved from <http://ajplegacy.physiology.org/content/169/3/609.short>
- Lark, S., Buckley, J., Bennett, S., Jones, D., & Sargeant, A. (2003). Joint torques and dynamic joint stiffness in elderly and young men during stepping down. *Clinical Biomechanics*, 18(9), 848–855. [https://doi.org/10.1016/S0268-0033\(03\)00150-5](https://doi.org/10.1016/S0268-0033(03)00150-5)
- LaRoche, D., & Connolly, D. (2006). Effects of stretching on passive muscle tension and response to eccentric exercise. *The American Journal of Sports Medicine*, 34(6), 1000–1007. <https://doi.org/10.1177/0363546505284238>
- Larsen, R., Lund, H., Christensen, R., Røgind, H., Danneskiold-Samsøe, B., &
-

-
- Bliddal, H. (2005). Effect of static stretching of quadriceps and hamstring muscles on knee joint position sense. *British Journal of Sports Medicine*, 39(1), 43–46. <https://doi.org/10.1136/bjism.2003.011056>
- Larsson, L., & Moss, R. (1993). Maximum velocity of shortening in relation to myosin isoform composition in single fibres from human skeletal muscles. *The Journal of Physiology*, 472(1), 595–614. <https://doi.org/10.1113/jphysiol.1993.sp019964>
- Latash, M. (1998). Neurophysiological basis of human movement. (pp. 98–105). Champaign, IL: Human Kinetics.
- Lattanzio, P., & Petrella, R. (1998). Knee proprioception: a review of mechanisms, measurements, and implications of muscular fatigue. *Orthopedics*, 21(4), 463–70; discussion 470–1; passim. <https://doi.org/10.3928/0147-7447-19980401-19>
- Lattanzio, P., Petrella, R., Sproule, J., & Fowler, P. (1997). Effects of fatigue on knee proprioception. *Clinical Journal of Sport Medicine*, 7(1), 22–27. <https://doi.org/10.1097/00042752-199610000-00034>
- Laurent, D., Portero, P., Goubel, F., & Rossi, A. (1993). Electromyogram spectrum changes during sustained contraction related to proton and diprotonated inorganic phosphate accumulation: a ³¹P nuclear magnetic resonance study on human calf muscles. *European Journal of Applied Physiology and Occupational Physiology*, 66(3), 263–268. <https://doi.org/10.1007/BF00235104>
- Law, R., Harvey, L., Nicholas, M., Tonkin, L., De Sousa, M., & Finnis, D. (2009). Stretch exercises increase tolerance to stretch in patients with chronic musculoskeletal pain: A randomized controlled trial. *Physical Therapy*, 89(10), 1016–1026. <https://doi.org/10.2522/ptj.20090056>
- Layec, G., Bringard, A., Le Fur, Y., Vilmen, C., Micallef, J., Perrey, S., ... Bendahan, D. (2009). Effects of a prior high-intensity knee-extension exercise on muscle recruitment and energy cost: a combined local and global investigation in humans. *Experimental Physiology*, 94(6), 704–719. <https://doi.org/10.1113/expphysiol.2008.044651>
-

- Lee, S., Gaebler-Spira, D., Zhang, L., Rymer, W., & Steele, K. (2016). Use of shear wave ultrasound elastography to quantify muscle properties in cerebral palsy. *Clinical Biomechanics*, 31, 20–28.
<https://doi.org/10.1016/j.clinbiomech.2015.10.006>
- Lee, S., & Piazza, S. (2009). Built for speed: musculoskeletal structure and sprinting ability. *The Journal of Experimental Biology*, 212(22), 3700–3707.
<https://doi.org/10.1242/jeb.031096>
- Lee, S., Spear, S., & Rymer, W. (2015). Quantifying changes in material properties of stroke-impaired muscle. *Clinical Biomechanics*, 30(3), 269–275.
<https://doi.org/10.1016/j.clinbiomech.2015.01.004>
- Leonard, C. (1998). Principles of reflex action and motor control. In *Neuroscience of Human Movement* (pp. 70–99). St. Louis: Mosby.
- Lichtwark, G., Bougoulias, K., & Wilson, A. (2007). Muscle fascicle and series elastic element length changes along the length of the human gastrocnemius during walking and running. *Journal of Biomechanics*, 40(1), 157–164.
<https://doi.org/10.1016/j.jbiomech.2005.10.035>
- Lichtwark, G., & Wilson, A. (2008). Optimal muscle fascicle length and tendon stiffness for maximising gastrocnemius efficiency during human walking and running. *Journal of Theoretical Biology*, 252(4), 662–673.
<http://doi.org/https://doi.org/10.1016/j.jtbi.2008.01.018>
- Lieber, R. (2010). Skeletal muscle physiology. In *Skeletal muscle, structure, function, and plasticity: The physiological basis of rehabilitation*. (3rd ed., pp. 41–92). Philadelphia, PA: Lippincott Williams & Wilkins.
- Lieber, R., & Bodine-Fowler, S. (1993). Skeletal muscle mechanics: Implications for rehabilitation. *Physical Therapy*, 73(12), 844–856.
<https://doi.org/10.1093/ptj/73.12.844>
- Lieber, R., & Fridén, J. (2000). Functional and clinical significance of skeletal muscle architecture. *Muscle Nerve*, 23(11), 1647–1666. <https://doi.org/10.1002/1097->
-

4598(200011)23:11<1647::AID-MUS1>3.0.CO;2-M

- Lieber, R., Loren, G., & Fridén, J. (1994). In vivo measurement of human wrist extensor muscle sarcomere length changes. *Journal of Neurophysiology*, 71(3), 874–881. Retrieved from <http://jn.physiology.org/content/71/3/874.short>
- Lin, T., Cardenas, L., & Soslowsky, L. (2004). Biomechanics of tendon injury and repair. *Journal of Biomechanics*, 37(6), 865–877. <https://doi.org/10.1016/j.jbiomech.2003.11.005>
- Linke, W. (2000). Titin elasticity in the context of the sarcomere: force and extensibility measurements on single myofibrils. In H. Granzier & G. Pollack (Eds.), *Elastic filaments of the cell. Advances in experimental medicine and biology* (Vol. 481, pp. 179–206). Boston, MA: Springer US. https://doi.org/10.1007/978-1-4615-4267-4_11
- Linke, W., & Granzier, H. (1998). A spring tale: new facts on titin elasticity. *Biophysical Journal*, 75(6), 2613–2614. [https://doi.org/10.1016/S0006-3495\(98\)77706-9](https://doi.org/10.1016/S0006-3495(98)77706-9)
- Linke, W., & Leake, M. (2004). Multiple sources of passive stress relaxation in muscle fibres. *Physics in Medicine and Biology*, 49(16), 3613–3627. <https://doi.org/10.1088/0031-9155/49/16/009>
- Litsky, A., & Spector, M. (1994). Biomaterials. In S. Simon (Ed.), *Orthopaedic basic science*. Rosemont, IL: American Academy of Orthopedic Surgeons.
- Little, T., & Williams, A. (2006). Effects of differential stretching protocols during warm-ups on high-speed motor capacities in professional soccer players. *Journal of Strength and Conditioning Research*, 20(1), 203–207. <https://doi.org/10.1519/R-16944.1>
- Liversage, A., Holmes, D., Knight, P., Tskhovrebova, L., & Trinick, J. (2001). Titin and the sarcomere symmetry paradox. *Journal of Molecular Biology*, 305(3), 401–409. <https://doi.org/10.1006/jmbi.2000.4279>
- Lloyd, A. (1971). Surface electromyography during sustained isometric contractions.
-

Journal of Applied Physiology., 30(5), 713–719. Retrieved from
<http://jap.physiology.org/content/jap/30/5/713.full.pdf>

Lowery, R., Joy, J., Brown, L., Oliveira de Souza, E., Wistocki, D., Davis, G., ...
Wilson, J. (2014). Effects of static stretching on 1-mile uphill run performance.
Journal of Strength and Conditioning Research, 28(1), 161–167.
<https://doi.org/10.1519/JSC.0b013e3182956461>

Luomala, T., Pihlman, M., Heiskanen, J., & Stecco, C. (2014). Case study: Could
ultrasound and elastography visualized densified areas inside the deep fascia?
Journal of Bodywork and Movement Therapies, 18(3), 462–468.
<https://doi.org/10.1016/j.jbmt.2013.11.020>

MacIntosh, B., Gardiner, P., & McComas, A. (2006). *Skeletal Muscle : Form and
Function*. Human Kinetics.

MacIntosh, B., Neptune, R., & Horton, J. (2000). Cadence, power, and muscle
activation in cycle ergometry. *Medicine and Science in Sports and Exercise*,
32(7), 1281–1287. <https://doi.org/10.1097/00005768-200007000-00015>

Madding, S., Wong, J., Hallum, A., & Medeiros, J. (1987). Effect of duration of
passive stretch on hip abduction range of motion. *Journal of Orthopaedic and
Sports Physical Therapy*, 8(8), 409–416.
<https://doi.org/10.2519/jospt.1987.8.8.409>

Maganaris, C. (2001). Force-length characteristics of in vivo human skeletal muscle.
Acta Physiologica Scandinavica, 172(4), 279–285.
<https://doi.org/10.1046/j.1365-201X.2001.00799.x>

Maganaris, C. (2003). Force-length characteristics of the in vivo human
gastrocnemius muscle. *Clinical Anatomy*, 16(3), 215–223.
<https://doi.org/10.1002/ca.10064>

Maganaris, C., & Baltzopoulos, V. (1999). Predictability of in vivo changes in
pennation angle of human tibialis anterior muscle from rest to maximum
isometric dorsiflexion. *European Journal of Applied Physiology and*

Occupational Physiology, 79(3), 294–297.

<https://doi.org/10.1007/s004210050510>

Maganaris, C., Baltzopoulos, V., & Sargeant, A. (1998). In vivo measurements of the triceps surae complex architecture in man: Implications for muscle function. *The Journal of Physiology*, 512(2), 603–614. <https://doi.org/10.1111/j.1469-7793.1998.603be.x>

Maganaris, C., Baltzopoulos, V., & Sargeant, A. (2006). Human calf muscle responses during repeated isometric plantarflexions. *Journal of Biomechanics*, 39(7), 1249–1255. <https://doi.org/10.1016/j.jbiomech.2005.03.011>

Maganaris, C., Narici, M., & Maffulli, N. (2008). Biomechanics of the Achilles tendon. *Disability and Rehabilitation*, 30(20–22), 1542–1547. <https://doi.org/10.1080/09638280701785494>

Magnusson, S. (1998). Passive properties of human skeletal muscle during stretch maneuvers. A review. *Scandinavian Journal of Medicine and Science in Sports*, 8(2), 65–77. <https://doi.org/10.1111/j.1600-0838.1998.tb00171.x>

Magnusson, S., Aagaard, P., Rosager, S., Dyhre-Poulsen, P., & Kjaer, M. (2001). Load-displacement properties of the human triceps surae aponeurosis in vivo. *The Journal of Physiology*, 531(1), 277–288. <http://doi.org/10.1111/j.1469-7793.2001.0277j.x>

Magnusson, S., Qvortrup, K., Larsen, J., Rosager, S., Hanson, P., Aagaard, P., ... Kjaer, M. (2002). Collagen fibril size and crimp morphology in ruptured and intact Achilles tendons. *Matrix Biology*, 21(4), 369–377. [https://doi.org/10.1016/S0945-053X\(02\)00011-2](https://doi.org/10.1016/S0945-053X(02)00011-2)

Magnusson, S., & Renström, P. (2006). The European College of Sports Sciences Position statement: The role of stretching exercises in sports. *European Journal of Sport Science*, 6(2), 87–91. <https://doi.org/10.1080/17461390600617865>

Magnusson, S., Simonsen, E., Aagaard, P., Dyhre-Poulsen, P., McHugh, M., & Kjaer, M. (1996). Mechanical and physiological responses to stretching with and

without preisometric contraction in human skeletal muscle. *Archives of Physical Medicine and Rehabilitation*, 77(4), 373–378. [https://doi.org/10.1016/S0003-9993\(96\)90087-8](https://doi.org/10.1016/S0003-9993(96)90087-8)

Magnusson, S., Simonsen, E., Aagaard, P., Gleim, G., McHugh, M., & Kjaer, M. (1995). Viscoelastic response to repeated static stretching in the human hamstring muscle. *Scandinavian Journal of Medicine and Science in Sports*, 5(6), 342–347. <https://doi.org/10.1111/j.1600-0838.1995.tb00056.x>

Magnusson, S., Simonsen, E., Aagaard, P., & Kjaer, M. (1996). Biomechanical responses to repeated stretches in human hamstring muscle in vivo. *The American Journal of Sports Medicine*, 24(5), 622–628. <https://doi.org/10.1177/036354659602400510>

Magnusson, S., Simonsen, E., Aagaard, P., Sørensen, H., & Kjaer, M. (1996). A mechanism for altered flexibility in human skeletal muscle. *The Journal of Physiology*, 497(1), 291–298. <https://doi.org/10.1113/jphysiol.1996.sp021768>

Maïsetti, O., Hug, F., Bouillard, K., & Nordez, A. (2012). Characterization of passive elastic properties of the human medial gastrocnemius muscle belly using supersonic shear imaging. *Journal of Biomechanics*, 45(6), 978–984. <https://doi.org/https://doi.org/10.1016/j.jbiomech.2012.01.009>

Malcata, R., Vandenberghe, T., & Hopkins, W. (2014). Using athletes' world rankings to assess countries' performance. *International Journal of Sports Physiology and Performance*, 9(1), 133–138. <https://doi.org/10.1123/IJSPP.2013-0014>

Maldjian, J., Laurienti, P., & Burdette, J. (2004). Precentral gyrus discrepancy in electronic versions of the Talairach atlas. *NeuroImage*, 21(1), 450–455. <https://doi.org/10.1016/j.neuroimage.2003.09.032>

Maldjian, J., Laurienti, P., Kraft, R., & Burdette, J. (2003). An automated method for neuroanatomic and cytoarchitectonic atlas-based interrogation of fMRI data sets. *NeuroImage*, 19(3), 1233–1239. <https://doi.org/10.1016/S1053->

8119(03)00169-1

- Malisza, K., Stroman, P., Turner, A., Gregorash, L., Foniok, T., & Wright, A. (2003). Functional MRI of the rat lumbar spinal cord involving painful stimulation and the effect of peripheral joint mobilization. *Journal of Magnetic Resonance Imaging*, *18*(2), 152–159. <https://doi.org/10.1002/jmri.10339>
- Malliaropoulos, N., Papalexandris, S., Papalada, A., & Papacostas, E. (2004). The role of stretching in rehabilitation of hamstring injuries: 80 athletes follow-up. *Medicine and Science in Sports and Exercise*, *36*(5), 756–759. <https://doi.org/10.1249/01.MSS.0000126393.20025.5E>
- Mann, D., & Jones, M. (1999). Guidelines to the implementation of a dynamic stretching program. *Strength and Conditioning Journal*, *21*(6), 53–55. [https://doi.org/10.1519/1533-4295\(1999\)021<0053:GTTIOA>2.0.CO;2](https://doi.org/10.1519/1533-4295(1999)021<0053:GTTIOA>2.0.CO;2)
- Manoel, M., Harris-Love, M., Danoff, J., & Miller, T. (2008). Acute effects of static, dynamic, and proprioceptive neuromuscular facilitation stretching on muscle power in women. *Journal of Strength and Conditioning Research*, *22*(5), 1528–1534. <https://doi.org/10.1519/JSC.0b013e31817b0433>
- Marek, S., Cramer, J., Fincher, A., Massey, L., Dangelmaier, S., Purkayastha, S., ... Culbertson, J. (2005). Acute effects of static and proprioceptive neuromuscular facilitation stretching on muscle strength and power output. *Journal of Athletic Training*, *40*(2), 94–103. [https://doi.org/10.1016/S0162-0908\(08\)70360-X](https://doi.org/10.1016/S0162-0908(08)70360-X)
- Markos, P. (1979). Ipsilateral and contralateral effects of proprioceptive neuromuscular facilitation techniques on hip motion and electromyographic activity. *Physical Therapy*, *59*(11), 1366–1373.
- Marshall, P., Cashman, A., & Cheema, B. (2011). A randomized controlled trial for the effect of passive stretching on measures of hamstring extensibility, passive stiffness, strength, and stretch tolerance. *Journal of Science and Medicine in Sport*, *14*(6), 535–540. <https://doi.org/10.1016/j.jsams.2011.05.003>
- Maruyama, K. (1997). Connectin/titin, giant elastic protein of muscle. *The FASEB*
-

Journal, 11(5), 341–345. Retrieved from
<http://www.ncbi.nlm.nih.gov/pubmed/9141500>

- Maruyama, K., Murakami, F., & Ohashi, K. (1977). Connectin, an elastic protein of muscle. *Comparative Biochemistry. Journal of Biochemistry*, 82(2), 339–345.
- Matthews, P. (1991). The human stretch reflex and the motor cortex. *Trends in Neurosciences*, 14(3), 87–91. [https://doi.org/10.1016/0166-2236\(91\)90064-2](https://doi.org/10.1016/0166-2236(91)90064-2)
- McHugh, M., Connolly, D., Eston, R., & Gleim, G. (1999). Exercise-induced muscle damage and potential mechanisms for the repeated bout effect. *Sports Medicine*, 27(3), 157–170. <https://doi.org/10.2165/00007256-199927030-00002>
- McHugh, M., & Cosgrave, C. (2010). To stretch or not to stretch: The role of stretching in injury prevention and performance. *Scandinavian Journal of Medicine and Science in Sports*, 20(2), 169–181. <https://doi.org/10.1111/j.1600-0838.2009.01058.x>
- McLean, S., Huang, X., & van den Bogert, A. (2008). Investigating isolated neuromuscular control contributions to non-contact anterior cruciate ligament injury risk via computer simulation methods. *Clinical Biomechanics*, 23(7), 926–936. <https://doi.org/http://dx.doi.org/10.1016/j.clinbiomech.2008.03.072>
- McMahon, T., & Cheng, G. (1990). The mechanics of running: How does stiffness couple with speed? *Journal of Biomechanics*, 23(1), 65–78.
[https://doi.org/10.1016/0021-9290\(90\)90042-2](https://doi.org/10.1016/0021-9290(90)90042-2)
- McMillian, D., Moore, J., Hatler, B., & Taylor, D. (2006). Dynamic vs. static stretching warm up: The effect on power and agility performance. *Journal of Strength and Conditioning Research*, 20(3), 492–499. <https://doi.org/10.1519/18205.1>
- McNair, P., Hewson, D., Dombroski, E., & Stanley, S. (2002). Stiffness and passive peak force changes at the ankle joint: The effect of different joint angular velocities. *Clinical Biomechanics*, 17(7), 536–540.
[https://doi.org/10.1016/S0268-0033\(02\)00062-1](https://doi.org/10.1016/S0268-0033(02)00062-1)
-

- McNair, P., & Stanley, S. (1996). Effect of passive stretching and jogging on the series elastic muscle stiffness and range of motion of the ankle joint. *British Journal of Sports Medicine*, 30(4), 313–317.
<https://doi.org/10.1136/bjsm.30.4.313>
- Merletti, R., Farina, D., Frericks, B., & Harlaar, J. (1999). European recommendations for signal processing methods for surface electromyography. In G. Hermens, H.J., Frericks, B., Merletti, R. Stegeman, D. Block, J. Rau, G. Disselhorst-Klug, C. and Hagg (Ed.), *European recommendations for surface electromyography: Results of the SENIAM Project* (pp. 57–68). Enschede: Roessingh Research and Development.
- Mero, A., Komi, P., & Gregor, R. (1992). Biomechanics of Sprint Running. *Sports Medicine*, 13(6), 376–392. <https://doi.org/10.2165/00007256-199213060-00002>
- Meunier, S., & Pierrot-Deseilligny, E. (1989). Gating of the afferent volley of the monosynaptic stretch reflex during movement in man. *The Journal of Physiology*, 419, 753–763. <https://doi.org/10.1113/jphysiol.1989.sp017896>
- Minshull, C., Eston, R., Bailey, A., Rees, D., & Gleeson, N. (2014). The differential effects of PNF versus passive stretch conditioning on neuromuscular performance. *European Journal of Sport Science*, 14(3), 233–241.
<https://doi.org/10.1080/17461391.2013.799716>
- Miyamoto, N., Hirata, K., Kanehisa, H., & Yoshitake, Y. (2015). Validity of measurement of shear modulus by ultrasound shear wave elastography in human pennate muscle. *PLoS ONE*, 10(4), e0124311.
<https://doi.org/10.1371/journal.pone.0124311>
- Mizuno, T. (2017). Changes in joint range of motion and muscle–tendon unit stiffness after varying amounts of dynamic stretching. *Journal of Sports Sciences*, 35(21), 2157–2163. <https://doi.org/10.1080/02640414.2016.1260149>
- Mizuno, T., & Umemura, Y. (2016). Dynamic stretching does not change the stiffness of the muscle-tendon unit. *International Journal of Sports Medicine*, 37(13), 1044–1050. <https://doi.org/10.1055/s-0042-108807>
-

- Mojock, C., Kim, J., Eccles, D., & Panton, L. (2011). The effects of static stretching on running economy and endurance performance in female distance runners during treadmill running. *Journal of Strength and Conditioning Research*, 25(8), 2170–2176. <https://doi.org/10.1519/JSC.0b013e3181e859db>
- Moore, I. (2016). Is there an economical running technique? A review of modifiable biomechanical factors affecting running economy. *Sports Medicine*, 46(6), 793–807. <https://doi.org/10.1007/s40279-016-0474-4>
- Moore, I., Jones, A., & Dixon, S. (2014). Relationship between metabolic cost and muscular coactivation across running speeds. *Journal of Science and Medicine in Sport*, 17(6), 671–676. <https://doi.org/10.1016/j.jsams.2013.09.014>
- Moore, J. (1992). Function, structure, and responses of components of the muscle-tendon unit. *Occupational Medicine*, 7(4), 713–740.
- Moore, M., & Hutton, R. (1980). Electromyographic investigation of muscle stretching techniques. *Medicine and Science in Sports and Exercise*, 12(5), 322–329. <https://doi.org/10.1249/00005768-198012050-00004>
- Moore, M., & Kukulka, C. (1991). Depression of Hoffmann reflexes following voluntary contraction and implications for proprioceptive neuromuscular facilitation therapy. *Physical Therapy*, 71(4), 321–329. <https://doi.org/10.1093/ptj/71.4.321>
- Morgan, D., & Allen, D. (1999). Early events in stretch-induced muscle damage. *Journal of Applied Physiology*, 87(6), 2007–2015. <https://doi.org/Review>
- Morgan, D., Baldini, F., Martin, P., & Kohrt, W. (1989). Ten kilometer performance and predicted velocity at VO₂max among well-trained male runners. *Medicine and Science in Sports and Exercise*, 21(1), 78–83. <https://doi.org/10.1249/00005768-198902000-00014>
- Morgan, D., Martin, P., Krahenbuhl, G., & Baldini, F. (1991). Variability in running
-

economy and mechanics among trained male runners. *Medicine and Science in Sports and Exercise*, 23(3), 378–383. <https://doi.org/10.1249/00005768-199103000-00018>

Morse, C., Degens, H., Seynnes, O., Maganaris, C., & Jones, D. (2008). The acute effect of stretching on the passive stiffness of the human gastrocnemius muscle tendon unit. *The Journal of Physiology*, 586(1), 97–106. <https://doi.org/10.1113/jphysiol.2007.140434>

Moritani, T., Nagata, A., Muro, M., & Moritani, T. (1982). Electromyographic manifestations of muscular fatigue. *Medicine and Science in Sports and Exercise*, 14(3), 198–202. <https://doi.org/10.1249/00005768-198203000-00008>

Muhl, Z. (1982). Active length-tension relation and the effect of muscle pinnation on fiber lengthening. *Journal of Morphology*, 173(3), 285–292. <https://doi.org/10.1002/jmor.1051730305>

Murphy, A., & Wilson, G. (1997). The ability of tests of muscular function to reflect training-induced changes in performance. *Journal of Sports Sciences*, 15(2), 191–200. <http://doi.org/10.1080/026404197367461>

Mutungi, G., & Ranatunga, K. (1996). The viscous, viscoelastic and elastic characteristics of resting fast and slow mammalian (rat) muscle fibres. *The Journal of Physiology*, 496(3), 827–836. <https://doi.org/10.1113/jphysiol.1996.sp021730>

Myers, T. (1997). The “anatomy trains.” *Journal of Bodywork and Movement Therapies*, 1(2), 91–101.

Myers, T. (2014). *Anatomy trains : myofascial meridians for manual and movement therapists* (3rd ed.). London: Churchill Livingstone.

Nakamura, M., Ikezoe, T., Kobayashi, T., Umegaki, H., Takeno, Y., Nishishita, S., & Ichihashi, N. (2014). Acute effects of static stretching on muscle hardness of the medial gastrocnemius muscle belly in humans: An ultrasonic shear-wave

elastography study. *Ultrasound in Medicine and Biology*, 40(9), 1991–1997.

<https://doi.org/10.1016/j.ultrasmedbio.2014.03.024>

Nakamura, M., Ikezoe, T., Takeno, Y., & Ichihashi, N. (2011). Acute and prolonged effect of static stretching on the passive stiffness of the human gastrocnemius muscle tendon unit in vivo. *Journal of Orthopaedic Research*, 29(11), 1759–1763. <https://doi.org/10.1002/jor.21445>

Nakamura, M., Ikezoe, T., Takeno, Y., & Ichihashi, N. (2013). Time course of changes in passive properties of the gastrocnemius muscle–tendon unit during 5 min of static stretching. *Manual Therapy*, 18(3), 211–215. <https://doi.org/10.1016/j.math.2012.09.010>

Narici, M., Binzoni, T., Hiltbrand, E., Fasel, J., Terrier, F., & Cerretelli, P. (1996). In vivo human gastrocnemius architecture with changing joint angle at rest and during graded isometric contraction. *The Journal of Physiology*, 496(1), 287–297. <https://doi.org/10.1113/jphysiol.1996.sp021685>

Needham, R., Morse, C., & Degens, H. (2009). The acute effect of different warm-up protocols on anaerobic performance in elite youth soccer players. *Journal of Strength and Conditioning Research*, 23(9), 2614–2620. <https://doi.org/10.1519/JSC.0b013e3181b1f3ef>

Nelson, A., Allen, J., Cornwell, A., & Kokkonen, J. (2001). Inhibition of maximal voluntary isometric torque production by acute stretching is joint-angle specific. *Research Quarterly for Exercise and Sport*, 72(1), 68–70. <https://doi.org/10.1080/02701367.2001.10608934>

Nelson, A., Driscoll, N., Landin, D., Young, M., & Schexnayder, I. (2005). Acute effects of passive muscle stretching on sprint performance. *Journal of Sports Sciences*, 23(5), 449–454. <https://doi.org/10.1080/02640410410001730205>

Nelson, A., Guillory, I., Cornwell, C., & Kokkonen, J. (2001). Inhibition of maximal voluntary isokinetic torque production following stretching is velocity-specific. *Journal of Strength and Conditioning Research*, 15(2), 241–246. [https://doi.org/10.1519/1533-4287\(2001\)015<0241:IOMVIT>2.0.CO;2](https://doi.org/10.1519/1533-4287(2001)015<0241:IOMVIT>2.0.CO;2)

- Nelson, A., Kokkonen, J., Eldredge, C., Cornwell, A., & Glickman-Weiss, E. (2001). Chronic stretching and running economy. *Scandinavian Journal of Medicine and Science in Sports*, 11(5), 260–265. <https://doi.org/10.1034/j.1600-0838.2001.110502.x>
- Nelson, R., & Bandy, W. (2004). Eccentric training and static stretching improve hamstring flexibility of high school males. *Journal of Athletic Training*, 39(3), 254–258. <https://doi.org/10.1519/jsc.0b013e31828ddd53>
- Nelson, R., & Bandy, W. (2005). An update on flexibility. *Strength and Conditioning Journal*, 27(1), 10–16. <https://doi.org/10.1519/00126548-200502000-00001>
- Nicol, C., Avela, J., & Komi, P. (2006). The stretch-shortening cycle. *Sports Medicine*, 36(11), 977–999. <https://doi.org/10.2165/00007256-200636110-00004>
- Nicol, C., & Komi, P. (1998). Significance of passively induced stretch reflexes on achilles tendon force enhancement. *Muscle and Nerve*, 21(11), 1546–1548. [https://doi.org/10.1002/\(SICI\)1097-4598\(199811\)21:11<1546::AID-MUS29>3.0.CO;2-X](https://doi.org/10.1002/(SICI)1097-4598(199811)21:11<1546::AID-MUS29>3.0.CO;2-X)
- Nigg, B., & Enders, H. (2013). Barefoot running—some critical considerations. *Footwear Science*, 5(1), 1–7. <https://doi.org/10.1080/19424280.2013.766649>
- Nigg, B., & Herzog, W. (2007). *Biomechanics of the musculo-skeletal system*. (B. M. Nigg & W. Herzog, Eds.) (3rd ed.). Chichester, UK: John Wiley.
- Nordez, A., Casari, P., & Cornu, C. (2008). Effects of stretching velocity on passive resistance developed by the knee musculo-articular complex: Contributions of frictional and viscoelastic behaviours. *European Journal of Applied Physiology*, 103(2), 243–250. <https://doi.org/10.1007/s00421-008-0695-9>
- Nordez, A., Cornu, C., & McNair, P. (2006). Acute effects of static stretching on passive stiffness of the hamstring muscles calculated using different mathematical models. *Clinical Biomechanics*, 21(7), 755–760. <https://doi.org/10.1016/j.clinbiomech.2006.03.005>
- Nordez, A., Fouré, A., Dombroski, E., Mariot, J., Cornu, C., & McNair, P. (2010).
-

-
- Improvements to Hoang et al.'s method for measuring passive length-tension properties of human gastrocnemius muscle in vivo. *Journal of Biomechanics*, 43(2), 379–382. <https://doi.org/10.1016/j.jbiomech.2009.07.034>
- Nordez, A., Gross, R., Andrade, R., Le Sant, G., Freitas, S., Ellis, R., ... Hug, F. (2017). Non-muscular structures can limit the maximal joint range of motion during stretching. *Sports Medicine*, 47(10), 1925–1929. <https://doi.org/10.1007/s40279-017-0703-5>
- Nordez, A., McNair, P., Casari, P., & Cornu, C. (2009). The effect of angular velocity and cycle on the dissipative properties of the knee during passive cyclic stretching: A matter of viscosity or solid friction. *Clinical Biomechanics*, 24(1), 77–81. <https://doi.org/10.1016/j.clinbiomech.2008.10.004>
- Norman, R., & Komi, P. (1979). Electromechanical delay in skeletal muscle under normal movement conditions. *Acta Physiologica Scandinavica*, 106(3), 241–248. <https://doi.org/10.1111/j.1748-1716.1979.tb06394.x>
- Norris, C. (2004). *The complete guide to stretching* (3rd ed.). London: A & C Black.
- Novacheck, T. (1998). The biomechanics of running. *Gait and Posture*, 7(1), 77–95. [https://doi.org/10.1016/S0966-6362\(97\)00038-6](https://doi.org/10.1016/S0966-6362(97)00038-6)
- O'Brien, M. (1997). Structure and metabolism of tendons. *Scandinavian Journal of Medicine and Science in Sports*, 7(2), 55–61. <https://doi.org/10.1111/j.1600-0838.1997.tb00119.x>
- O'Sullivan, K., Murray, E., & Sainsbury, D. (2009). The effect of warm-up, static stretching and dynamic stretching on hamstring flexibility in previously injured subjects. *BMC Musculoskeletal Disorders*, 10(1), 37. <https://doi.org/10.1186/1471-2474-10-37>
- Ochiai, N., Matsui, T., Miyaji, N., Merklin, R., & Hunter, J. (1979). Vascular anatomy of flexor tendons. I. Vincular system and blood supply of the profundus tendon in the digital sheath. *The Journal of Hand Surgery*, 4(4), 321–330. [https://doi.org/10.1016/S0363-5023\(79\)80068-4](https://doi.org/10.1016/S0363-5023(79)80068-4)
-

- Osternig, L., Robertson, R., Troxel, R., & Hansen, P. (1987). Muscle activation during proprioceptive neuromuscular facilitation (PNF) stretching techniques. *American Journal of Physical Medicine*, 66(5), 298–307.
<https://doi.org/10.1097/00002060-198710000-00009>
- Osternig, L., Robertson, R., Troxel, R., & Hansen, P. (1990). Differential responses to proprioceptive neuromuscular facilitation (PNF) stretch techniques. *Medicine and Science in Sports and Exercise*, 22(1), 106–111.
<https://doi.org/10.1249/00005768-199002000-00017>
- Özkaya, N., & Nordin, M. (1999). Moment and torque. In *Fundamentals of Biomechanics: Equilibrium, Motion, and Deformation* (pp. 29–46). New York, NY: Springer New York. https://doi.org/10.1007/978-1-4757-3067-8_3
- Paavolainen, L., Hakkinen, K., Hamalainen, I., Nummela, A., & Rusko, H. (2003). Explosive-strength training improves 5-km running time by improving running economy and muscle power. *Scandinavian Journal of Medicine and Science in Sports*, 13(4), 272. <https://doi.org/10.1034/j.1600-0838.2003.00340.x>
- Page, P. (2012). Current concepts in muscle stretching for exercise and rehabilitation. *International Journal of Sports Physical Therapy*, 7(1), 109–19.
<https://doi.org/PMC3273886>
- Paine, T. (2015). *The complete guide to sports massage* (3rd ed.). London: Bloomsbury Publishing Plc.
- Papadopoulos, G., Siatras, T., & Kellis, S. (2005). The effect of static and dynamic stretching exercises on the maximal isokinetic strength of the knee extensors and flexors. *Isokinetics and Exercise Science*, 13, 285–291.
- Pappas, P., Paradisis, G., Exell, T., Smirniotou, A., Tsolakis, C., & Arampatzis, A. (2017). Acute effects of stretching on leg and vertical stiffness during treadmill running. *Journal of Strength and Conditioning Research*, 31(12), 3417–3424.
<https://doi.org/10.1519/JSC.0000000000001777>
-

- Paradisis, G., Pappas, P., Theodorou, A., Zacharogiannis, E., Skordilis, E., & Smirniotou, A. (2014). Effects of static and dynamic stretching on sprint and jump performance in boys and girls. *Journal of Strength and Conditioning Research*, 28(1), 154–160. <https://doi.org/10.1519/JSC.0b013e318295d2fb>
- Pearce, A., Kidgell, D., Zois, J., & Carlson, J. (2009). Effects of secondary warm up following stretching. *European Journal of Applied Physiology*, 105(2), 175–183. <https://doi.org/10.1007/s00421-008-0887-3>
- Pearce, A., Latella, C., & Kidgell, D. (2012). Secondary warm-up following stretching on vertical jumping, change of direction, and straight line speed. *European Journal of Sport Science*, 12(2), 103–112. <https://doi.org/10.1080/17461391.2010.551412>
- Pearson, S., & McMahon, J. (2012). Lower limb mechanical properties: Determining factors and implications for performance. *Sports Medicine*, 42(11), 929–940. <https://doi.org/10.2165/11635110-000000000-00000>
- Peltonen, J., Cronin, N., Stenroth, L., Finni, T., & Avela, J. (2013). Viscoelastic properties of the Achilles tendon in vivo. *SpringerPlus*, 2(1), 212. <https://doi.org/10.1186/2193-1801-2-212>
- Perrier, E., Pavol, M., & Hoffman, M. (2011). The acute effects of a warm-up including static or dynamic stretching on countermovement jump height, reaction time, and flexibility. *Journal of Strength and Conditioning Research*, 25(7), 1925–1931. <https://doi.org/10.1519/JSC.0b013e3181e73959>
- Pert, A. (1982). Mechanisms of opiate analgesia and the role of endorphins in pain suppression. *Advances in Neurology*, 33, 107–122.
- Petersen, J., & Hölmich, P. (2005). Evidence based prevention of hamstring injuries in sport. *British Journal of Sports Medicine*, 39(6), 319–323. <https://doi.org/10.1136/bjism.2005.018549>
- Petit, J., Filippi, G., Emonet-Denand, F., Hunt, C., & Laporte, Y. (1990). Changes in
-

muscle stiffness produced by motor units of different types in peroneus longus muscle of cat. *Journal of Neurophysiology*, 63(1), 190–197. Retrieved from <http://jn.physiology.org/content/63/1/190>

Piercey, M., Moon, M., Blinn, J., & Dobry-Schreur, P. (1986). Analgesic activities of spinal cord substance P antagonists implicate substance P as a neurotransmitter of pain sensation. *Brain Research*, 385(1), 74–85. [https://doi.org/10.1016/0006-8993\(86\)91549-0](https://doi.org/10.1016/0006-8993(86)91549-0)

Pollack, G. (1990). *Muscles & molecules : uncovering the principles of biological motion*. Seattle: Ebner & Sons Publishers.

Powell, D., Williams, D., Windsor, B., Butler, R., & Zhang, S. (2014). Ankle work and dynamic joint stiffness in high- compared to low-arched athletes during a barefoot running task. *Human Movement Science*, 34, 147–156. <https://doi.org/10.1016/j.humov.2014.01.007>

Powers, S., & Howley, E. (2012). *Exercise physiology: Theory and application to fitness and performance*. McGraw-Hill Humanities/Social Sciences/Languages.

Prentice, W. (1983). A comparison of static stretching and PNF stretching for improving hip joint flexibility. *Athletic Training*, 18(1), 56–59.

Prentice, W. (2010). *Essentials of athletic injury management* (10th ed.). McGraw-Hill Education.

Prentice, W. (2015). *Get fit, stay fit* (7th ed.). Philadelphia, PA: F.A. Davis Company.

Prochazka, A., & Ellaway, P. (2012). Sensory systems in the control of movement. *Comprehensive Physiology*, 2(4), 2615–2627. <https://doi.org/10.1002/cphy.c100086>

Proske, U., & Rack, P. (1976). Short-range stiffness of slow fibers and twitch fibers in reptilian muscle. *American Journal of Physiology*, 231(2), 449–453. Retrieved from <http://ajplegacy.physiology.org/content/231/2/449>

- Purslow, P. (1989). Strain-induced reorientation of an intramuscular connective tissue network: Implications for passive muscle elasticity. *Journal of Biomechanics*, 22(1), 21–31. [https://doi.org/10.1016/0021-9290\(89\)90181-4](https://doi.org/10.1016/0021-9290(89)90181-4)
- Rall, J. (1985). Energetic aspects of skeletal muscle contraction: implications of fiber types. *Exercise and Sport Sciences Reviews*, 13(1), 33-74. <https://doi.org/10.1249/00003677-198500130-00004>
- Rana, M., Hamarneh, G., & Wakeling, J. (2009). Automated tracking of muscle fascicle orientation in B-mode ultrasound images. *Journal of Biomechanics*, 42(13), 2068–2073. <https://doi.org/10.1016/j.jbiomech.2009.06.003>
- Ranatunga, K. (2001). Sarcomeric visco-elasticity of chemically skinned skeletal muscle fibres of the rabbit at rest. *Journal of Muscle Research and Cell Motility*, 22(5), 399–414. <https://doi.org/10.1023/A:1014502610259>
- Rassier, D., MacIntosh, B., & Herzog, W. (1999). Length dependence of active force production in skeletal muscle. *Journal of Applied Physiology*, 86(5), 1445–1457. Retrieved from <http://jap.physiology.org/content/86/5/1445.long>
- Reeves, N., & Narici, M. (2003). Behavior of human muscle fascicles during shortening and lengthening contractions in vivo. *Journal of Applied Physiology*, 95(3), 1090–1096. <https://doi.org/10.1152/jappphysiol.01046.2002>
- Reid, D., & McNair, P. (2004). Passive force, angle, and stiffness changes after stretching of hamstring muscles. *Medicine and Science in Sports and Exercise*, 36(11), 1944–1948. <https://doi.org/10.1249/01.MSS.0000145462.36207.20>
- Riebe, D., Ehrman, J., Liguori, G., & Magal, M. (2018). *ACSM's guidelines for exercise testing and prescription*. Philadelphia(PA): Lippincott Williams & Wilkins.
- Riemann, B., DeMont, R., Ryu, K., & Lephart, S. (2001). The effects of sex, joint angle, and the gastrocnemius muscle on passive ankle joint complex stiffness. *Journal of Athletic Training*, 36(4), 369–377.
-

- Riemann, B., & Lephart, S. (2002). The sensorimotor system, part I: The physiologic basis of functional joint stability. *Journal of Athletic Training*, 37(1), 71–79. <https://doi.org/10.1016/j.jconhyd.2010.08.009>
- Rigby, B., Hirai, N., & Spikes, J. (1959). The mechanical properties of rat tail tendon. *The Journal of General Physiology*, 43(2), 265–283. <https://doi.org/10.1085/jgp.43.2.265>
- Ringleb, S., Bensamoun, S., Chen, Q., Manduca, A., An, K., & Ehman, R. (2007). Applications of magnetic resonance elastography to healthy and pathologic skeletal muscle. *Journal of Magnetic Resonance Imaging: JMRI*, 25(2), 301–309. <https://doi.org/10.1002/jmri.20817>
- Rixon, K., Lamont, H., & Bembem, M. (2007). Influence of type of muscle contraction, gender, and lifting experience on postactivation potentiation performance. *Journal of Strength and Conditioning Research*, 21(2), 500–505. <https://doi.org/10.1519/r-18855.1>
- Roberts, T. (1997). Muscular force in running turkeys: The economy of minimizing work. *Science*, 275(5303), 1113–1115. <https://doi.org/10.1126/science.275.5303.1113>
- Rogasch, N., Burne, J., Binboža, E., & Türker, K. (2011). Synaptic potentials contributing to reflex inhibition in gastrocnemius following tendon electrical stimulation. *Clinical Neurophysiology*, 122(6), 1190–1196. <https://doi.org/10.1016/j.clinph.2010.11.010>
- Rorden, C., & Brett, M. (2000). Stereotaxic display of brain lesions. *Behavioural Neurology*, 12(4), 191–200. <https://doi.org/10.1155/2000/421719>
- Rosager, S., Aagaard, P., Dyhre-Poulsen, P., Neergaard, K., Kjaer, M., & Magnusson, S. (2002). Load-displacement properties of the human triceps surae aponeurosis and tendon in runners and non-runners. *Scandinavian Journal of Medicine and Science in Sports*, 12(2), 90–98. <http://doi.org/10.1034/j.1600-0838.2002.120205.x>
-

- Rosenbaum, D., & Hennig, E. M. (1995). The influence of stretching and warm-up exercises on Achilles tendon reflex activity. *Journal of Sports Sciences*, 13(6), 481–490. <https://doi.org/10.1080/02640419508732265>
- Rossi-Durand, C. (2002). The influence of increased muscle spindle sensitivity on Achilles tendon jerk and H-reflex in relaxed human subjects. *Somatosensory & Motor Research*, 19(4), 286–295. <https://doi.org/10.1080/0899022021000037755>
- Royer, D., Gennisson, J., Deffieux, T., & Tanter, M. (2011). On the elasticity of transverse isotropic soft tissues (L). *The Journal of the Acoustical Society of America*, 129(5), 2757–2760. <https://doi.org/10.1121/1.3559681>
- Rubini, E., Costa, A., & Gomes, P. (2007). The effects of stretching on strength performance. *Sports Medicine*, 37(33), 213–224. <https://doi.org/10.2165/00007256-200737030-00003>
- Rutherford, O., & Jones, D. (1992). Measurement of fibre pennation using ultrasound in the human quadriceps in vivo. *European Journal of Applied Physiology and Occupational Physiology*, 65(5), 433–437. <https://doi.org/10.1007/BF00243510>
- Ryan, E., Beck, T., Herda, T., Hull, H., Hartman, M., Costa, P., ... Cramer, J. (2008). The time course of musculotendinous stiffness responses following different durations of passive stretching. *Journal of Orthopaedic and Sports Physical Therapy*, 38(10), 632–639. <https://doi.org/10.2519/jospt.2008.2843>
- Sady, S., Wortman, M., & Blanke, D. (1982). Flexibility training: ballistic, static or proprioceptive neuromuscular facilitation? *Archives of Physical Medicine and Rehabilitation*, 63(6), 261–263.
- Safran, M., Seaber, A., & Garrett, W. (1989). Warm-up and muscular injury prevention an update. *Sports Medicine*, 8(4), 239–249. <https://doi.org/10.2165/00007256-198908040-00004>
- Sainz De Baranda, P., & Ayala, F. (2010). Chronic flexibility improvement after 12 week of stretching program utilizing the ACSM recommendations: Hamstring
-

-
- flexibility. *International Journal of Sports Medicine*, 31(6), 389–396.
<https://doi.org/10.1055/s-0030-1249082>
- Sale, D. (2002). Postactivation potentiation: role in human performance. *Exercise and Sport Sciences Reviews*, 30(3), 138–143.
<https://doi.org/10.1136/bjism.2002.003392>
- Sale, D. (2004). Postactivation potentiation: role in performance. *British Journal of Sports Medicine*, 38(4), 386–387. <https://doi.org/10.1136/bjism.2002.003392>
- Saltin, B., Larsen, H., Terrados, N., Bangsbo, J., Bak, T., Kim, C., ... Rolf, C. (1995). Aerobic exercise capacity at sea level and at altitude in Kenyan boys, junior and senior runners compared with Scandinavian runners. *Scandinavian Journal of Medicine and Science in Sports*, 5(4), 209–221. <https://doi.org/10.1111/j.1600-0838.1995.tb00037.x>
- Samuel, M., Holcomb, W., Guadagnoli, M., Rubley, M., & Wallmann, H. (2008). Acute effects of static and ballistic stretching on measures of strength and power. *Journal of Strength and Conditioning Research*, 22(5), 1422–1428.
<https://doi.org/10.1519/JSC.0b013e318181a314>
- Samukawa, M., Hattori, M., Sugama, N., & Takeda, N. (2011). The effects of dynamic stretching on plantar flexor muscle-tendon tissue properties. *Manual Therapy*, 16(6), 618–622. <https://doi.org/10.1016/j.math.2011.07.003>
- Sandel, M. (2013). Dr. Herman Kabat: Neuroscience in translation ... from bench to bedside. *Physical Medicine and Rehabilitation*, 5(6), 453–461.
<https://doi.org/10.1016/j.pmrj.2013.04.020>
- Sandow, A. (1965). Excitation-contraction coupling in skeletal muscle. *Pharmacological Reviews*, 17(3), 265–320.
- Sarvazyan, A., Rudenko, O., Swanson, S., Fowlkes, J., & Emelianov, S. (1998). Shear wave elasticity imaging: A new ultrasonic technology of medical diagnostics. *Ultrasound in Medicine and Biology*, 24(9), 1419–1435.
-

[https://doi.org/10.1016/S0301-5629\(98\)00110-0](https://doi.org/10.1016/S0301-5629(98)00110-0)

- Sarvazyan, A., Urban, M., & Greenleaf, J. (2013). Acoustic Waves in Medical Imaging and Diagnostics. *Ultrasound in Medicine and Biology*, 39(7), 1133–1146. <https://doi.org/10.1016/j.ultrasmedbio.2013.02.006>
- Sasaki, K., & Neptune, R. (2006). Muscle mechanical work and elastic energy utilization during walking and running near the preferred gait transition speed. *Gait & Posture Posture*, 23(3), 383–390. <https://doi.org/10.1016/j.gaitpost.2005.05.002>
- Satterthwaite, T., Wolf, D., Loughead, J., Ruparel, K., Elliott, M., Hakonarson, H., ... Gur, R. (2012). Impact of in-scanner head motion on multiple measures of functional connectivity: Relevance for studies of neurodevelopment in youth. *NeuroImage*, 60(1), 623–632. <https://doi.org/10.1016/j.neuroimage.2011.12.063>
- Saunders, P., Pyne, D., Telford, R., & Hawley, J. (2004). Factors affecting running economy in trained distance runners. *Sports Medicine*, 34(7), 465–485. <https://doi.org/10.2165/00007256-200434070-00005>
- Saunders, P., Telford, R., & Pyne, D. (2004). Improved running economy in elite runners after 20 days of simulated moderate-altitude exposure. *Journal of Applied Physiology*, 96(3), 931–937. <https://doi.org/https://doi.org/10.1152/jappphysiol.00725.2003>
- Saunders, P., Telford, R., Pyne, D., Hahn, A., & Gore, C. (2009). Improved running economy and increased hemoglobin mass in elite runners after extended moderate altitude exposure. *Journal of Science and Medicine in Sport*, 12(1), 67–72. <https://doi.org/10.1016/j.jsams.2007.08.014>
- Saunders, P., Telford, R., Pyne, D., Peltola, E., Cunningham, R., Gore, C., & Hawley, J. (2006). Short-term plyometric training improves running economy in highly trained middle and long distance runners. *Journal of Strength and Conditioning Research*, 20(4), 947–954. <https://doi.org/10.1519/R-18235.1>
-

- Sayers, A., Farley, R., Fuller, D., Jubenville, C., & Caputo, J. (2008). The effect of static stretching on phases of sprint performance in elite soccer players. *Journal of Strength and Conditioning Research*, 22(5), 1416–1421. <https://doi.org/10.1519/JSC.0b013e318181a450>
- Schache, A., & Baker, R. (2007). On the expression of joint moments during gait. *Gait & Posture*, 25(3), 440–452. <https://doi.org/10.1016/j.gaitpost.2006.05.018>
- Schaible, H., & Grubb, B. (1993). Afferent and spinal mechanisms of joint pain. *Pain*, 55(1), 5–54. [https://doi.org/10.1016/0304-3959\(93\)90183-P](https://doi.org/10.1016/0304-3959(93)90183-P)
- Schaible, H., & Schmidt, R. (1985). Effects of an experimental arthritis on the sensory properties of fine articular afferent units. *Journal of Neurophysiology*, 54(5), 1109–22. [https://doi.org/10.1016/0304-3959\(86\)90183-1](https://doi.org/10.1016/0304-3959(86)90183-1)
- Schleip, R., Duerselen, L., Vleeming, A., Naylor, I., Lehmann-Horn, F., Zorn, A., ... Klingler, W. (2012). Strain hardening of fascia: Static stretching of dense fibrous connective tissues can induce a temporary stiffness increase accompanied by enhanced matrix hydration. *Journal of Bodywork and Movement Therapies*, 16(1), 94–100. <https://doi.org/10.1016/j.jbmt.2011.09.003>
- Screen, H., Lee, D., Bader, D., & Shelton, J. (2004). An investigation into the effects of the hierarchical structure of tendon fascicles on micromechanical properties. *Proceedings of the Institution of Mechanical Engineers. Part H, Journal of Engineering in Medicine*, 218(2), 109–119. <https://doi.org/10.1243/095441104322984004>
- Sekir, U., Arabaci, R., Akova, B., & Kadagan, S. (2010). Acute effects of static and dynamic stretching on leg flexor and extensor isokinetic strength in elite women athletes. *Scandinavian Journal of Medicine and Science in Sports*, 20(2), 268–281. <https://doi.org/10.1111/j.1600-0838.2009.00923.x>
- Semenick, D. (1994). Testing protocols and procedures. In T. Baechle & R. Earle (Eds.), *Essentials of strength training and conditioning* (pp. 258–273). Champaign, IL: Human Kinetics.
-

- Serpell, M. (2006). Anatomy, physiology and pharmacology of pain. *Surgery*, 24(10), 350–353. <https://doi.org/10.1053/j.mpsur.2006.08.002>
- Sforzo, G. (1989). Opioids and exercise: An update. *Sports Medicine*, 7(2), 109–124. <https://doi.org/10.2165/00007256-198907020-00003>
- Shadwick, R. (1990). Elastic energy storage in tendons: mechanical differences related to function and age. *Journal of Applied Physiology*, 68(3), 1033–1040. Retrieved from <http://jap.physiology.org/content/68/3/1033.long>
- Sharma, L., Pai, Y., Holtkamp, K., & Rymer, W. (1997). Is knee joint proprioception worse in the arthritic knee versus the unaffected knee in unilateral knee osteoarthritis? *Arthritis and Rheumatism*, 40(8), 1518–1525. <https://doi.org/10.1002/art.1780400821>
- Sharman, M., & Cresswell, A. (2006). Enhancing evidence based practice of PNF stretching. In C. C. O. Committee (Ed.), *13th Commonwealth International Sport Conference Program and Abstracts* (pp. 204–204). Jolimont, Vic, Australia: Sports Medicine Australia.
- Shehab, R., Mirabelli, M., Gorenflo, D., & Fetters, M. (2006). Pre-exercise stretching and sports related injuries: knowledge, attitudes and practices. *Clinical Journal of Sport Medicine*, 16(3), 228–231. <https://doi.org/10.1097/00042752-200605000-00007>
- Shellock, F., & Prentice, W. (1985). Warming-up and stretching for improved physical performance and prevention of sports-related injuries. *Sports Medicine*, 2(4), 267–278. <https://doi.org/10.2165/00007256-198502040-00004>
- Shrier, I. (1999). Stretching before exercise does not reduce the risk of local muscle injury: a critical review of the clinical and basic science literature. *Clinical Journal of Sport Medicine*, 9(4), 221–227. <https://doi.org/10.1097/00042752-199910000-00007>
- Shrier, I. (2000). Stretching before exercise: an evidence based approach. *British Journal of Sports Medicine*, 34(5), 324–325.
-

<https://doi.org/10.1136/bjism.34.5.324>

Shrier, I. (2005). Stretching perspectives. *Current Sports Medicine Reports*, 4(5), 237–238. <https://doi.org/10.1097/01.CSMR.0000306215.95056.8a>

Shrout, P., & Fleiss, J. (1979). Intraclass correlations: Uses in assessing rater reliability. *Psychological Bulletin*, 86(2), 420–428. <https://doi.org/10.1037/0033-2909.86.2.420>

Siatras, T., & Papadopoulos, G. (2003). Static and dynamic acute stretching effect on gymnasts' speed in vaulting. *Pediatric Exercise Science*, 15(4), 383–391. <https://doi.org/10.1123/pes.15.4.383>

Slawinski, J., Demarle, A., Koralsztejn, J., & Billat, V. (2001). Effect of supra-lactate threshold training on the relationship between mechanical stride descriptors and aerobic energy cost in trained runners. *Archives of Physiology and Biochemistry*, 109(2), 110–116. <https://doi.org/10.1076/apab.109.2.110.4270>

Small, K., Mc Naughton, L., & Matthews, M. (2008). A systematic review into the efficacy of static stretching as part of a warm-up for the prevention of exercise-related injury. *Research in Sports Medicine*, 16(3), 213–231. <https://doi.org/10.1080/15438620802310784>

Smith, H., Vacek, P., Johnson, R., Slauterbeck, J., Hashemi, J., Shultz, S., & Beynon, B. (2012). Risk factors for anterior cruciate ligament injury. *Sports Health*, 4(2), 155–161. <https://doi.org/10.1177/1941738111428282>

Smith, J. (1976). Fusimotor loop properties and involvement during voluntary movement. *Exercise and Sport Sciences Reviews*, 4(1), 297–333.

Smith, J., & Fry, A. (2007). Effects of a ten-second maximum voluntary contraction on regulatory myosin light-chain phosphorylation and dynamic performance measures. *Journal of Strength and Conditioning Research*, 21(1), 73–76. <https://doi.org/10.1519/00124278-200702000-00014>

Smith, L., Brunetz, M., Chenier, T., McCammon, M., Houmard, J., Franklin, M., &

-
- Israel, R. (1993). The effects of static and ballistic stretching on delayed onset muscle soreness and creatine kinase. *Research Quarterly for Exercise and Sport*, 64(1), 103–107. <https://doi.org/10.1080/02701367.1993.10608784>
- Smith, T., & Hopkins, W. (2011). Variability and predictability of finals times of elite rowers. *Medicine and Science in Sports and Exercise*, 43(11), 2155–2160. <https://doi.org/10.1249/MSS.0b013e31821d3f8e>
- Smith, L., Preece, S., Mason, D., & Bramah, C. (2015). A comparison of kinematic algorithms to estimate gait events during overground running. *Gait and Posture*, 41(1), 39–43. <http://doi.org/10.1016/j.gaitpost.2014.08.009>
- Sparks, C., Cleland, J., Elliott, J., Zagardo, M., & Liu, W. (2013). Using functional magnetic resonance imaging to determine if cerebral hemodynamic responses to pain change following thoracic spine thrust manipulation in healthy individuals. *The Journal of Orthopaedic and Sports Physical Therapy*, 43(5), 340–348. <https://doi.org/10.2519/jospt.2013.4631>
- Spector, S., Gardiner, P., Zernicke, R., Roy, R., & Edgerton, V. (1980). Muscle architecture and force-velocity characteristics of cat soleus and medial gastrocnemius: implications for motor control. *Journal of Neurophysiology*, 44(5), 951–960. Retrieved from <http://jn.physiology.org/content/44/5/951>
- Spudich, J. (2001). The myosin swinging cross-bridge model. *Nature Reviews Molecular Cell Biology*, 2(5), 387–392. <https://doi.org/10.1038/35073086>
- Spurrs, R., Murphy, A., & Watsford, M. (2003). The effect of plyometric training on distance running performance. *European Journal of Applied Physiology*, 89(1), 1–7. <https://doi.org/10.1007/s00421-002-0741-y>
- Stauber, W. (1989). Eccentric action of muscles: physiology, injury, and adaptation. *Exercise and Sport Sciences Reviews*, 17(1), 157–186. <https://doi.org/10.1249/00003677-198900170-00008>
- Stecco, C., Macchi, V., Porzionato, A., Duparc, F., & De Caro, R. (2011). The fascia: the forgotten structure. *Italian Journal of Anatomy and Embryology = Archivio*
-

italiano Di Anatomia Ed Embriologia, 116(3), 127–138.

Stegeman, D., & Hermens, H. (1998). Standards for surface electromyography: The European project Surface EMG for non-invasive assessment of muscles (SENIAM). In B. Hermens, H, Rau, , Disselhorst-Klug C, Freriks (Ed.), *Surface Electromyography Application Areas and Parameters. Proceedings of the Third General SENIAM Workshop on surface electromyography* (pp. 108–112).

Aachen, Germany. Retrieved from

<http://www.seniam.org/%5Cnhttp://www.med.uni->

[jena.de/motorik/pdf/stegeman.pdf](http://www.seniam.org/%5Cnhttp://www.med.uni-jena.de/motorik/pdf/stegeman.pdf)

Stienen, G., Kiers, J., Bottinelli, R., & Reggiani, C. (1996). Myofibrillar ATPase activity in skinned human skeletal muscle fibres: fibre type and temperature dependence. *The Journal of Physiology*, 493(2), 299–307.

<https://doi.org/10.1113/jphysiol.1996.sp021384>

Stirling, L., von Tscharnner, V., Kugler, P., & Nigg, B. (2011). Classification of muscle activity based on effort level during constant pace running. *Journal of Electromyography and Kinesiology*, 21(4), 566–571.

<https://doi.org/10.1016/j.jelekin.2011.02.005>

Storen, O., Helgerud, J., Stoa, E., Stkren, K., Helgerud, J., Stka, E., & Hoff, J. (2008). Maximal strength training improves running economy in distance runners. *Medicine and Science in Sports and Exercise*, 40(6), 1089–1094.

<https://doi.org/10.1249/MSS.0b013e318168da2f>

Sweeney, H., Bowman, B., & Stull, J. (1993). Myosin light chain phosphorylation in vertebrate striated muscle: regulation and function. *American Journal of Physiology - Cell Physiology*, 264(5), C1085–C1095. Retrieved from

<http://ajpcell.physiology.org/content/264/5/C1085>

Tanigawa, M. (1972). Comparison of the hold-relax procedure and passive mobilization on increasing muscle length. *Physical Therapy*, 52(7), 725–735.

- Taniguchi, K., Shinohara, M., Nozaki, S., & Katayose, M. (2015). Acute decrease in the stiffness of resting muscle belly due to static stretching. *Scandinavian Journal of Medicine and Science in Sports*, 25(1), 32–40. <https://doi.org/10.1111/sms.12146>
- Tanter, M., Bercoff, J., Athanasiou, A., & Deffieux, T. (2008). Quantitative assessment of breast lesion viscoelasticity: initial clinical results using supersonic shear imaging. *Ultrasound in Medicine and Biology*, 34(9), 1373–1386. <https://doi.org/10.1016/j.ultrasmedbio.2008.02.002>
- Tanzer, M. (1973). Cross-linking of collagen. *Science*, 180(4086), 561–566. Retrieved from <http://science.sciencemag.org/content/180/4086/561>
- Tatsumi, H., Murakami, S., Tsuji, R., Ishida, Y., Murakami, K., Masaki, A., ... Motaf, H. (1991). Cloning and expression in yeast of a cDNA clone encoding *Aspergillus oryzae* neutral protease II, a unique metalloprotease. *Molecular and General Genetics MGG*, 228(1), 97–103. <https://doi.org/10.1007/BF00282453>
- Taylor, D., Dalton, J., Seaber, A., & Garrett, W. (1990). Viscoelastic properties of muscle-tendon units. The biomechanical effects of stretching. *The American Journal of Sports Medicine*, 18(3), 300–309. <https://doi.org/10.1177/036354659001800314>
- Taylor, D., Brooks, D., & Ryan, J. (1997). Viscoelastic characteristics of muscle: passive stretching versus muscular contractions. *Medicine and Science in Sports and Exercise*, 29(12), 1619–1624. <https://doi.org/10.1097/00005768-199712000-00011>
- Taylor, J., Butler, J., & Gandevia, S. (2000). Changes in muscle afferents, motoneurons and motor drive during muscle fatigue. *European Journal of Applied Physiology*, 83(2–3), 106–115. <https://doi.org/10.1007/s004210000269>
- Taylor, K., Sheppard, J., Lee, H., & Plummer, N. (2017). Negative effect of static stretching restored when combined with a sport specific warm-up component. *Journal of Science and Medicine in Sport*, 12(6), 657–661. <https://doi.org/10.1016/j.jsams.2008.04.004>
-

- Terman, G., Shavit, Y., Lewis, J., Cannon, J., & Liebeskind, J. (1984). Intrinsic mechanisms of pain inhibition: activation by stress. *Science*, 226(4680), 1270–1277. <https://doi.org/10.1126/science.6505691>
- Tew, G., Klonizakis, M., Moss, J., Ruddock, A., Saxton, J., & Hodges, G. (2011). Reproducibility of cutaneous thermal hyperaemia assessed by laser Doppler flowmetry in young and older adults. *Microvascular*, 81(2), 177–182. <https://doi.org/10.1016/j.mvr.2010.12.001>
- Thacker, S., Gilchrist, J., Stroup, D., & Kimsey, C. (2004). The impact of stretching on sports injury Risk: A systematic review of the literature. *Medicine and Science in Sports and Exercise*, 36(3), 371–378. <https://doi.org/10.1249/01.MSS.0000117134.83018.F7>
- Theis, N., Korff, T., Kairon, H., & Mohagheghi, A. (2013). Does acute passive stretching increase muscle length in children with cerebral palsy? *Clinical Biomechanics*, 28(9–10), 1061–1067. <https://doi.org/10.1016/j.clinbiomech.2013.10.001>
- Theis, N., Korff, T., & Mohagheghi, A. (2015). Does long-term passive stretching alter muscle–tendon unit mechanics in children with spastic cerebral palsy? *Clinical Biomechanics*, 30(10), 1071–1076. <https://doi.org/10.1016/j.clinbiomech.2015.09.004>
- Thompsen, A., Kackley, T., Palumbo, M., & Faigenbaum, A. (2007). Acute effects of different warm-up protocols with and without a weighted vest on jumping performance in athletic women. *Journal of Strength and Conditioning Research*, 21(1), 52–56. <https://doi.org/10.1519/R-18965.1>
- Thorstensson, A., Grimby, G., & Karlsson, J. (1976). Force-velocity relations and fiber composition in human knee extensor muscles. *Journal of Applied Physiology*, 40(1), 12–16. Retrieved from <http://jap.physiology.org/content/40/1/12.short>
- Tihanyi, J., Apor, P., & Petrekanits, M. (1987). Force-velocity-power characteristics for extensors of lower extremities. In B. Jonsson (Ed.), *Biomechanics X-B* (Vol.
-

6B, pp. 707–712). Champaign, IL: Human Kinetics.

- Tillin, N., & Bishop, D. (2009). Factors modulating post-activation potentiation and its effect on performance of subsequent explosive activities. *Sports Medicine*, 39(2), 147–166. <https://doi.org/10.2165/00007256-200939020-00004>
- Tilp, M., Steib, S., Schappacher-Tilp, G., & Herzog, W. (2011). Changes in fascicle lengths and pennation angles do not contribute to residual force enhancement/depression in voluntary contractions. *Journal of Applied Biomechanics*, 27(1), 64–73. <https://doi.org/10.1123/jab.27.1.64>
- Toft, E., Sinkjær, T., Kålund, S., & Espersen, G. (1989). Biomechanical properties of the human ankle in relation to passive stretch. *Journal of Biomechanics*, 22(11–12), 1129–1132. [https://doi.org/10.1016/0021-9290\(89\)90214-5](https://doi.org/10.1016/0021-9290(89)90214-5)
- Torres, E., Kraemer, W., Vingren, J., Volek, J., Hatfield, D., Spiering, B., ... Maresh, C. (2008). Effects of stretching on upper-body muscular performance. *Journal of Strength and Conditioning Research*, 22(4), 1279–1285. <https://doi.org/10.1519/JSC.0b013e31816eb501>
- Trehearn, T., & Buresh, R. (2009). Sit-and-reach flexibility and running economy of men and women collegiate distance runners. *Journal of Strength and Conditioning Research*, 23(1), 158–162. <https://doi.org/10.1519/JSC.0b013e31818eaf49>
- Trimble, M., & Harp, S. (1998). Postexercise potentiation of the H-reflex in humans. *Medicine and Science in Sports and Exercise*, 30(6), 933–941. <http://doi.org/10.1097/00005768-199806000-00024>
- Trinick, J. (1994). Titin and nebulin: Protein rulers in muscle? *Trends in Biochemical Sciences*, 19(10), 405–409. [https://doi.org/10.1016/0968-0004\(94\)90088-4](https://doi.org/10.1016/0968-0004(94)90088-4)
- Trinick, J. (1996). Titin as a scaffold and spring. Cytoskeleton. *Current Biology: CB*, 6(3), 258–260. [https://doi.org/10.1016/S0960-9822\(02\)00472-4](https://doi.org/10.1016/S0960-9822(02)00472-4)
- Trinick, J., & Tskhovrebova, L. (1999). Titin: A molecular control freak. *Trends in Cell Biology*, 9(10), 377–380. [https://doi.org/10.1016/S0962-8924\(99\)01641-4](https://doi.org/10.1016/S0962-8924(99)01641-4)
-

- Tskhovrebova, L., & Trinick, J. (2000). Extensibility in the titin molecule and its relation to muscle elasticity. In H. L. Granzier & G. H. Pollack (Eds.), *Elastic Filaments of the Cell* (pp. 163–178). Boston, MA: Springer US.
https://doi.org/10.1007/978-1-4615-4267-4_10
- Tsolakis, C., Bogdanis, G., Nikolaou, A., & Zacharogiannis, E. (2011). Influence of type of muscle contraction and gender on postactivation potentiation of upper and lower limb explosive performance in elite fencers. *Journal of Sports Science and Medicine*, 10(3), 577–583. Retrieved from
<http://www.jssm.org/research.php?id=jssm-10-577.xml>
- Tubman, L., MacIntosh, B., & Maki, W. (1996). Myosin light chain phosphorylation and posttetanic potentiation in fatigued skeletal muscle. *Pflügers Archiv*, 431(6), 882–887. <http://doi.org/10.1007/BF02332173>
- Turki, O., Chaouachi, A., Behm, D., Chtara, H., Chtara, M., Bishop, D., ... Amri, M. (2012). The effect of warm-ups incorporating different volumes of dynamic stretching on 10- and 20-m sprint performance in highly trained male athletes. *Journal of Strength and Conditioning Research*, 26(1), 63–72.
<https://doi.org/10.1519/JSC.0b013e31821ef846>
- Turki, O., Chaouachi, A., Drinkwater, E., Chtara, M., Chamari, K., Amri, M., & Behm, D. (2011). Ten minutes of dynamic stretching is sufficient to potentiate vertical jump performance characteristics. *Journal of Strength and Conditioning Research*, 25(9), 2453–2463. <https://doi.org/10.1519/JSC.0b013e31822a5a79>
- Turner, A., Owings, M., & Schwane, J. (2003). Improvement in running economy after 6 weeks of plyometric training. *Journal of Strength and Conditioning Research*, 17(1), 60–67. [https://doi.org/10.1519/1533-4287\(2003\)017<0060:IIREAW>2.0.CO;2](https://doi.org/10.1519/1533-4287(2003)017<0060:IIREAW>2.0.CO;2)
- Van Dijk, K., Sabuncu, M., & Buckner, R. (2012). The influence of head motion on intrinsic functional connectivity MRI. *NeuroImage*, 59(1), 431–438.
<https://doi.org/10.1016/j.neuroimage.2011.07.044>
- Van Gelder, L., & Bartz, S. (2011). The effect of acute stretching on agility
-

-
- performance. *Journal of Strength and Conditioning Research*, 25(11), 3014–3021. <https://doi.org/10.1519/JSC.0b013e318212e42b>
- Vestergaard-Poulsen, P., Thomsen, C., Sinkjær, T., Stubgaard, M., Rosenfalck, A., & Henriksen, O. (1992). Simultaneous electromyography and ³¹P nuclear magnetic resonance spectroscopy—with application to muscle fatigue. *Electroencephalography and Clinical Neurophysiology*, 85(6), 402–411. [https://doi.org/10.1016/0168-5597\(92\)90054-F](https://doi.org/10.1016/0168-5597(92)90054-F)
- Vetter, R. (2007). Effects of six warm-up protocols on sprint and jump performance. *Journal of Strength and Conditioning Research*, 21(3), 819–823. <https://doi.org/10.1519/R-20296.1>
- Vogel, K. (2003). Tendon structure and response to changing mechanical load. *Journal of Musculoskeletal Neuronal Interactions*, 3(4), 323–325. Retrieved from <http://ismni.org/jmni/pdf/14/20VOGEL.pdf>
- Voigt, M., Bojsen-Møller, F., Simonsen, E., & Dyhre-Poulsen, P. (1995). The influence of tendon young's modulus, dimensions and instantaneous moment arms on the efficiency of human movement. *Journal of Biomechanics*, 28(3), 281–291. [https://doi.org/10.1016/0021-9290\(94\)00071-B](https://doi.org/10.1016/0021-9290(94)00071-B)
- Vos, E., Harlaar, J., & van Ingen Schenau, G. (1991). Electromechanical delay during knee extensor contractions. *Medicine and Science in Sports and Exercise*, 23(10), 1187–1193. <https://doi.org/10.1249/00005768-199110000-00013>
- Voss, D., Ionta, M., & Myers, B. (1985). *Proprioceptive neuromuscular facilitation, patterns and techniques* (3rd ed.). Philadelphia: Harper and Row.
- Vries, H. (1962). Evaluation of static stretching procedures for improvement of flexibility. *Research Quarterly. American Association for Health, Physical Education and Recreation*, 33(2), 222–229. <https://doi.org/10.1080/10671188.1962.10613194>
-

- Vujnovich, A., & Dawson, N. (1994). The effect of therapeutic muscle stretch on neural processing. *The Journal of Orthopaedic and Sports Physical Therapy*, 20(3), 145–53. <https://doi.org/10.2519/jospt.1994.20.3.145>
- Wallin, D., Ekblom, B., Grahn, R., & Nordenborg, T. (1985). Improvement of muscle flexibility. *The American Journal of Sports Medicine*, 13(4), 263–268. <https://doi.org/10.1177/036354658501300409>
- Wallmann, H., Christensen, S., Perry, C., & Hoover, D. (2012). The acute effects of various types of stretching static, dynamic, ballistic, and no stretch of the iliopsoas on 40-yard sprint times in recreational runners. *International Journal of Sports Physical Therapy*, 7(5), 540–547. Retrieved from <https://www.ncbi.nlm.nih.gov/pmc/articles/PMC3474300/>
- Walshe, A., Wilson, G., & Murphy, A. (1996). The validity and reliability of a test of lower body musculotendinous stiffness. *European Journal of Applied Physiology and Occupational Physiology*, 73(3), 332–339. <https://doi.org/10.1007/BF02425495>
- Wang, J. (2006). Mechanobiology of tendon. *Journal of Biomechanics*, 39(9), 1563–1582. <https://doi.org/10.1016/j.jbiomech.2005.05.011>
- Wang, J., Guo, Q., & Li, B. (2012). Tendon biomechanics and mechanobiology - A minireview of basic concepts and recent advancements. *Journal of Hand Therapy*, 25(2), 133–141. <https://doi.org/10.1016/j.jht.2011.07.004>
- Wang, K. (1996). Titin/connectin and nebulin: Giant protein rulers of muscle structure and function. *Advances in Biophysics*, 33, 123–134. [https://doi.org/10.1016/0065-227X\(96\)81668-6](https://doi.org/10.1016/0065-227X(96)81668-6)
- Webright, W., Randolph, B., & Perrin, D. (1997). Comparison of nonballistic active knee extension in neural slump position and static stretch techniques on hamstring flexibility. *Journal of Orthopaedic and Sports Physical Therapy*, 26(1), 7–13. <https://doi.org/10.2519/jospt.1997.26.1.7>
- Weerapong, P., Hume, P., & Kolt, G. (2004). Stretching: Mechanisms and benefits
-

-
- for sport performance and injury prevention. *Physical Therapy Reviews*, 9(4), 189–206. <https://doi.org/10.1179/108331904225007078>
- Weir, D., Tingley, J., & Elder, G. (2005). Acute passive stretching alters the mechanical properties of human plantar flexors and the optimal angle for maximal voluntary contraction. *European Journal of Applied Physiology*, 93(5–6), 614–623. <https://doi.org/10.1007/s00421-004-1265-4>
- Weldon, S., & Hill, R. (2003). The efficacy of stretching for prevention of exercise-related injury: A systematic review of the literature. *Manual Therapy*, 8(3), 141–150. [https://doi.org/10.1016/S1356-689X\(03\)00010-9](https://doi.org/10.1016/S1356-689X(03)00010-9)
- Weppler, C., & Magnusson, S. (2010). Increasing muscle extensibility: a matter of increasing length or modifying sensation? *Physical Therapy*, 90(3), 438–449. <https://doi.org/10.2522/ptj.20090012>
- Werstein, K., & Lund, R. (2012). The effects of two stretching protocols on the reactive strength index in female soccer and rugby players. *Journal of Strength and Conditioning Research*, 26(6), 1564–1567. <https://doi.org/10.1519/JSC.0b013e318231ac09>
- Whitehead, N., Weerakkody, N., Gregory, J., Morgan, D., & Proske, U. (2001). Changes in passive tension of muscle in humans and animals after eccentric exercise. *Journal of Physiology*, 533(2), 593–604. <https://doi.org/10.1111/j.1469-7793.2001.0593a.x>
- Wickiewicz, T., Roy, R., Powell, P., & Edgerton, V. (1983). Muscle architecture of the human lower limb. *Clinical Orthopaedics and Related Research*, (179), 275–283. <https://doi.org/009-921X/83/1000/275>
- Wickiewicz, T., Roy, R., Powell, P., Perrine, J., & Edgerton, V. (1984). Muscle architecture and force-velocity relationships in humans. *Journal of Applied Physiology*, 57(2), 435–443. Retrieved from <http://jap.physiology.org/content/57/2/435.long>
- Wilke, J., Krause, F., Vogt, L., & Banzer, W. (2016). What is evidence-based about
-

myofascial chains: A systematic review. *Archives of Physical Medicine and Rehabilitation*, 97(3), 454–461. <https://doi.org/10.1016/j.apmr.2015.07.023>

Wilkie, D. (1950). The relation between force and velocity in human muscle. *The Journal of Physiology*, 110(3–4), 249–280.

<https://doi.org/10.1113/jphysiol.1949.sp004437>

Willems, R., & Cristia, A. (2017). Hemodynamic methods: fMRI and fNIRS. In A. de Groot & P. Hagoort (Eds.), *Research methods in psycholinguistics and the neurobiology of language : a practical guide* (pp. 266–287). Hoboken, NJ: Wiley-Blackwell.

Williams, K. (1985). The relationship between mechanical and physiological energy estimates. *Medicine and Science in Sports and Exercise*, 17(3), 317–325.

<https://doi.org/10.1249/00005768-198506000-00004>

Williams, K., & Cavanagh, P. (1987). Relationship between distance running mechanics, running economy, and performance. *Journal of Applied Physiology*, 63(30), 1236–1245. Retrieved from

<http://jap.physiology.org/content/jap/63/3/1236.full.pdf>

Wilson, G., Elliott, B., & Wood, G. (1992). Stretch shorten cycle performance enhancement through flexibility training. *Medicine and Science in Sports and Exercise*, 24(1), 116–123. <https://doi.org/10.1249/00005768-199201000-00019>

Wilson, G., Murphy, A., & Pryor, J. (1994). Musculotendinous stiffness: its relationship to eccentric, isometric, and concentric performance. *Journal of Applied Physiology*, 76(6), 2714–2719. Retrieved from

<http://jap.physiology.org/content/76/6/2714>

Wilson, J., & Flanagan, E. (2008). The role of elastic energy in activities with high force and power requirements: a brief review. *Journal of Strength and Conditioning Research*, 22(5), 1705–1715.

<https://doi.org/10.1519/JSC.0b013e31817ae4a7>

- Wilson, J., Hornbuckle, L., Kim, J., Ugrinowitsch, C., Lee, S., Zourdos, M., ...
Panton, L. (2010). Effects of static stretching on energy cost and running endurance performance. *Journal of Strength and Conditioning Research*, 24(9), 2274–2279. <https://doi.org/10.1519/JSC.0b013e3181b22ad6>
- Winter, D. (1983). Moments of force and mechanical power in jogging. *Journal of Biomechanics*, 16(1), 91–97. [http://doi.org/https://doi.org/10.1016/0021-9290\(83\)90050-7](http://doi.org/https://doi.org/10.1016/0021-9290(83)90050-7)
- Winter, E., & Brookes, F. (1991). Electromechanical response times and muscle elasticity in men and women. *European Journal of Applied Physiology and Occupational Physiology*, 63(2), 124–128. <https://doi.org/10.1007/BF00235181>
- Winters, M., Blake, C., Trost, J., Marcello-Brinker, T., Lowe, L., Garber, M., & Wainner, R. (2004). Passive Versus Active Stretching of Hip Flexor Muscles in Subjects With Limited Hip Extension: A Randomized Clinical Trial. *Physical Therapy*, 84(9), 800–807. <https://doi.org/10.1093/ptj/84.9.800>
- Witvrouw, E., Mahieu, N., Danneels, L., & McNair, P. (2004). Stretching and injury prevention: An obscure relationship. *Sports Medicine*, 34(7), 443–449. <https://doi.org/10.2165/00007256-200434070-00003>
- Witvrouw, E., Mahieu, N., Roosen, P., & McNair, P. (2007). The role of stretching in tendon injuries. *British Journal of Sports Medicine*, 41(4), 224–226. <https://doi.org/10.1136/bjism.2006.034165>
- Wong, D., Chaouachi, A., Lau, P., & Behm, D. (2011). Short durations of static stretching when combined with dynamic stretching do not impair repeated sprints and agility. *Journal of Sports Science and Medicine*, 10(2), 408–416. Retrieved from <http://www.jssm.org/gecjssm-10-408.xml.xml>
- Woods, K., Bishop, P., & Jones, E. (2007). Warm-up and stretching in the prevention of muscular injury. *Sports Medicine*, 37(12), 1089–1099. <https://doi.org/10.2165/00007256-200737120-00006>
- Wright, G., Williams, L., Greany, J., & Foster, C. (2006). Effect of static stretching,
-

-
- dynamic stretching, and warm-up on active hip range of motion and vertical jump. *Medicine and Science in Sports and Exercise*, 38(5), S280–S281. <https://doi.org/10.1249/00005768-200605001-02090>
- Yamaguchi, T., & Ishii, K. (2005). Effects of static stretching for 30 seconds and dynamic stretching on leg extension power. *Journal of Strength and Conditioning Research*, 19(3), 677–683. <https://doi.org/10.1519/15044.1>
- Yamaguchi, T., Ishii, K., Yamanaka, M., & Yasuda, K. (2007). Acute effects of dynamic stretching exercise on power output during concentric dynamic constant external resistance leg extension. *Journal of Strength and Conditioning Research*, 21(4), 1238–1244. <https://doi.org/10.1519/R-21366.1>
- Yamaguchi, T., Takizawa, K., & Shibata, K. (2015). Acute effect of dynamic stretching on endurance running performance in well-trained male runners. *Journal of Strength and Conditioning Research*, 29(11), 3045–3052. <https://doi.org/10.1519/JSC.0000000000000969>
- Yeung, E., Balnave, C., Ballard, H., Bourreau, J., & Allen, D. (2002). Development of T-tubular vacuoles in eccentrically damaged mouse muscle fibres. *The Journal of Physiology*, 540(2), 581–592. <https://doi.org/10.1113/jphysiol.2001.013839>
- Young, W. (2007). The use of static stretching in warm-up for training and competition. *International Journal of Sports Physiology and Performance*, 2(2), 212–216. <https://doi.org/10.1123/ijsp.2.2.212>
- Young, W., & Behm, D. (2002). Should static stretching be used during a warm-Up for strength and power activities? *Strength and Conditioning Journal*, 24(6), 33–37. <https://doi.org/10.1519/00126548-200212000-00006>
- Yoshitake, Y., Miyamoto, N., Taniguchi, K., Katayose, M., & Kanehisa, H. (2016). The skin acts to maintain muscle shear modulus. *Ultrasound in Medicine and Biology*, 42(3), 674–682. <https://doi.org/10.1016/j.ultrasmedbio.2015.11.022>
- Young, W., & Elliott, S. (2001). Acute effects of static stretching, proprioceptive neuromuscular facilitation stretching, and maximum voluntary contractions on
-

explosive force production and jumping performance. *Research Quarterly for Exercise and Sport*, 72(3), 273–279.

<https://doi.org/10.1080/02701367.2001.10608960>

Zaheer, F., Roy, S., & De Luca, C. (2012). Preferred sensor sites for surface EMG signal decomposition. *Physiological Measurement*, 33(2), 195–206.

<https://doi.org/10.1088/0967-3334/33/2/195>

Zeni, J., Richards, J., & Higginson, J. (2008). Two simple methods for determining gait events during treadmill and overground walking using kinematic data. *Gait and Posture*, 27(4), 710–714. <https://doi.org/10.1016/j.gaitpost.2007.07.007>

Zhou, S., Lawson, D., Morrison, W., & Fairweather, I. (1995). Electromechanical delay in isometric muscle contractions evoked by voluntary, reflex and electrical stimulation. *European Journal of Applied Physiology and Occupational Physiology*, 70(2), 138–145. <https://doi.org/10.1007/BF00361541>

Zhou, S., McKenna, M., Lawson, D., Morrison, W., & Fairweather, I. (1996). Effects of fatigue and sprint training on electromechanical delay of knee extensor muscles. *European Journal of Applied Physiology and Occupational Physiology*, 72(5), 410–416. <https://doi.org/10.1007/BF00242269>

Zourdos, M., Bazylar, C., Jo, E., Khamoui, A., Park, B., Lee, S., ... Kim, J. (2017). Impact of a submaximal warm-up on endurance performance in highly trained and competitive male runners. *Research Quarterly for Exercise and Sport*, 88(1), 114–119. <https://doi.org/10.1080/02701367.2016.1224294>

Zourdos, M., Wilson, J., Sommer, B., Lee, S., Park, Y., Henning, P., ... Kim, J. (2012). Effects of dynamic stretching on energy cost and running endurance performance in trained male runners. *Journal of Strength and Conditioning Research*, 26(2), 335–341. <https://doi.org/10.1519/JSC.0b013e318225bbae>
