

# ASSESSMENT OF THE ULTIMATE RESPONSE OF COMPOSITE SLAB PANELS

**M. M. Florides**, *Brunel University London, UK*

**K. A. Cashell**, *Brunel University London, UK*

## ABSTRACT

It has been shown that steel-concrete composite floor systems can withstand loads and deflections far greater than those calculated by the traditional methods of design under fire conditions. In recent years, there has been considerable research focus directed towards developing the fundamental understanding of the complex behaviour of floor slabs and also improving the methods of analysis. Building on this work, the current paper describes the development and validation of a finite element model, developed using the ABAQUS software, which is capable of simulating the load-displacement response until failure. The model can represent the complexities of the behaviour including both the material and geometric nonlinearities and has been developed in five phases, including (i) unrestrained isolated strips (ii) restrained isolated strips (iii) unrestrained slabs (iv) restrained slabs and (v) an arrangement of three by three slab panels. The first four phases have been validated using data from tests on isolated elements and the current paper focuses mainly on the response of unrestrained two-way spanning slabs. The most salient parameters including boundary conditions, continuity and various other material and geometric properties are identified and studied. Comparisons with current design procedures are also discussed. The results of this investigation offer detailed insights into the key factors that govern the ultimate behaviour of buildings with composite floor systems under extreme loading conditions, and provide the essential background to enable the development of more performance-based design expressions.

## 1. INTRODUCTION

The structural fire engineering sector has received a significant increase in research attention in the decade following the Cardington project [1]. Considerable interest and effort has been focussed on moving from prescriptive-based design methods to more realistic and economic performance-based procedures. The contribution made by the floor slab system has been of particular interest. A number of purpose built numerical models have been developed by the research community to study the effects influencing the response of structures [e.g. 2, 3] and floor slabs in particular [e.g. 4,5] under fire loading scenarios. Although these models have led to considerable advancement in the understanding of structures in fire, they are often not suitable for design as they can be computationally expensive and the scale of the structures may be difficult to realistically represent. Consequently, simplified design methods such as the BRE Method [6] have been proposed in order to help engineers achieve safe and efficient designs. Although research has progressed to more detailed topics (e.g. connections and specific section types) the subject of developing design oriented expressions for composite slabs has not been overlooked. This paper proceeds with a brief summary of the key

work done to date. This is followed by a description of the Finite Element Model (FEM) which has been created in the commercial software package ABAQUS [7] to represent the ultimate response of lightly reinforced floor slabs. The model has been validated using test results from 14 two-way lightly reinforced concrete slab specimens [8]. Subsequently, the results are compared with those obtained utilising the finite element software VULCAN [4] and the BRE simplified design method. Future plans for the wider research project include further development of the FEM to examine the effects of elevated temperature on the floor behaviour. Furthermore scenarios where alternating compartments are heated and different boundary conditions are considered will be examined. In addition, an existing analytical method [9] will be further developed based on the findings.

## 2. PREVIOUS RESEARCH ON THE ULTIMATE BEHAVIOUR OF FLOOR SLABS

### 2.1 NUMERICAL ANALYSIS

Following the Cardington experiments, several purpose-built finite element programs and/or subroutines were developed to study and better

understand the behaviour of steel framed structures response in large displacements and fire; some of these are listed in Table 1 including their main capabilities.

Although the methods listed in Table 1 have been shown to perform extremely well and provide a good depiction of the response of steel framed composite structures in fire, the commercially-available finite element software ABAQUS was selected in the current work. This is because ABAQUS includes a wide range of element types and material models and can facilitate the future developments within this larger research project.

## 2.2 EXPERIMENTAL WORK

A series of lightly reinforced concrete slab specimens were tested during a previous research programme with the main aim of providing a greater insight into the large displacement behaviour of floor slab systems [8]. Experiments from this programme have been selected to calibrate and validate the models created in the current research. Figure 1 shows the general geometry of the two different types of specimens tested (aspect ratio of 1 and 1.5), while Table 2 provides the relevant geometric and material properties for all slab specimens. The reference system adopted in labelling each specimen is kept

the same as in the original work and is as follows: the first parameter denotes a rectangular (R) or square (S) slab; F40 and F60 represent the depth of the slab in mm; the third parameter describes the reinforcement used (P6 for plain bars of 6mm diameter, D6 for deformed bars of 6mm diameter, D8 for deformed bars of 8mm diameter and M6 for A142 welded mesh consisting of 6mm deformed bars spaced at 200mm centres) while A, B, C and D signify various reinforcement arrangements used. The table also includes information relating to the depth of the slab  $H$ , the long and short spans  $L_1$  and  $L_2$ , respectively, and also  $\rho_1$  and  $\rho_2$ , which are the reinforcement ratios in the long and short spans.

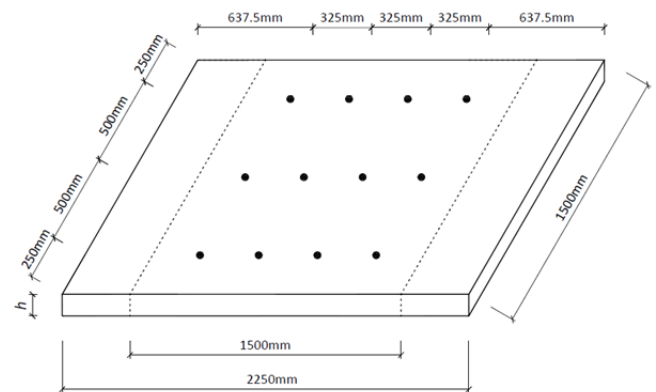

Figure 1: Layout of the slab specimens

**Table 1: Purpose built finite element programs and subroutines**

<i>Name</i>	<i>Developer</i>	<i>Main Capabilities</i>
SAFIR [3]	University of Liège, Belgium	Analysis of steel, concrete and composite structures using beam, truss, shell and solid elements.
FEAST [5] (sub-routine in ABAQUS)	University of Edinburgh, UK	Analysis of steel, concrete and composite structures in fire conditions using plate elements.
ADAPTIC [2]	Imperial College London, UK	Analysis of steel, concrete and composite structures using 1D elasto-plastic and 2D flat shell elements.
VULCAN [4]	University of Sheffield, UK	Analysis of steel, concrete and composite structures using beam-column, connection and layered floor slab elements.

**Table 2: Properties of the slab tests [8]**

<i>Model</i>	<i>L<sub>1</sub> (mm)</i>	<i>L<sub>2</sub> (mm)</i>	<i>H (mm)</i>	<i>Bar type</i>	<i>ρ<sub>1</sub> (%)</i>	<i>ρ<sub>2</sub> (%)</i>
R-F60-M6-A	2250	1500	60	M6	0.24	0.24
R-F60-P6-A	2250	1500	60	P6	0.24	0.24
S-F60-M6-A	1500	1500	60	M6	0.24	0.24
R-F40-D6-B	2250	1500	40	D6	0.35	0.35
R-F60-D6-C	2250	1500	60	D6	0.24	0.48
R-F60-D6-A	2250	1500	60	D6	0.24	0.24
S-F60-D6-A	1500	1500	60	D6	0.24	0.24
S-F60-D6-D	1500	1500	60	D6	0.52	0.52
S-F60-D8-D	1500	1500	60	D8	0.52	0.52
S-F60-P6-A	1500	1500	60	P6	0.24	0.24
R-F60-M6-A	2250	1500	60	M6	0.24	0.24
R-F40-M6-B	2250	1500	40	M6	0.35	0.35
R-F60-D8-A	2250	1500	60	D8	0.28	0.28
R-F60-D8-C	2250	1500	60	D8	0.28	0.56

### 3 DEVELOPMENT OF THE NUMERICAL MODEL

The numerical model has been developed using the commercially-available ABAQUS software. The concrete slab panels were modelled using 3D solid elements with reduced integration (C3D8R) from the ABAQUS library [7] while the reinforcement was modelled using linear 3D truss elements (T3D2) which were embedded in the solid slab elements. The concrete was represented using the concrete damaged plasticity model and the tension stiffening property of this model was employed to simulate the bond between the steel reinforcement and the surrounding concrete; this will be discussed in more detail later. Due to

symmetry, only one quarter of the slab was modelled, as shown in Figure 2. The boundary conditions and load application points were identical to those used in the tests and the loading plates were modelled using rigid shell elements to avoid any deformations. The slabs were loaded in displacement control using the same 12-point loading configuration as shown in Figure 3 which was designed to simulate a uniformly distributed load. Although ABAQUS includes several static analysis methods, in order to facilitate both the ambient and elevated-temperature loading (which is outside the scope of the current paper but an important part of the wider project), a quasi-static dynamic, implicit analysis was employed.

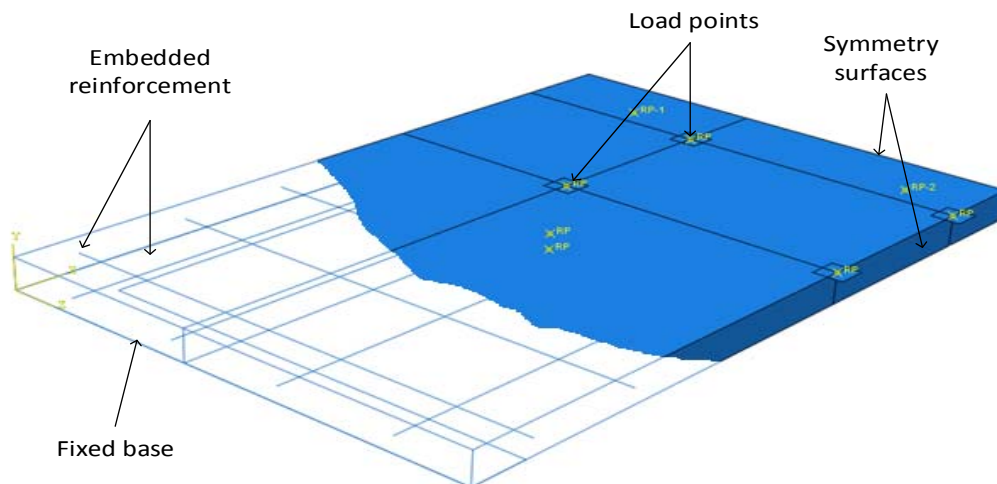
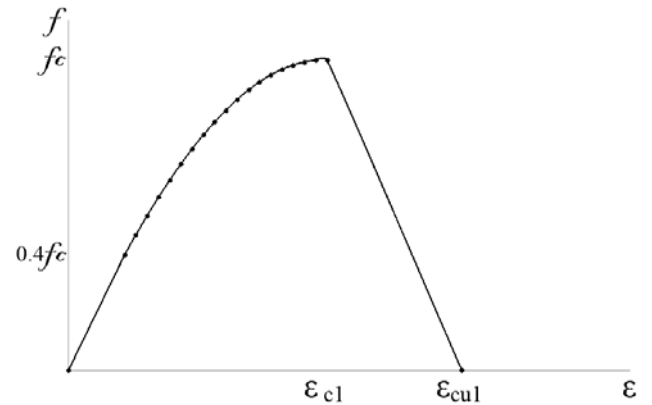

Figure 2: Assembly of the simulated slab model

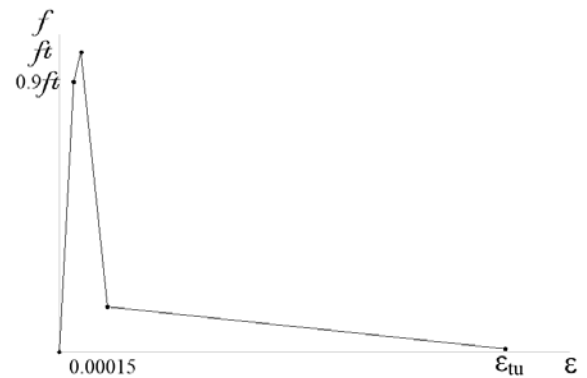

Figure 3: 12-point loading arrangement in the experimental programme [8]

The concrete damaged plasticity model uses the concept of isotropic damaged elasticity in combination with isotropic tensile and compressive plasticity to represent the inelastic behaviour of concrete and a combination of multi-hardening plasticity and isotropic damaged elasticity to describe the irreversible damage that occurs during the fracturing process. The stress-strain curves for concrete are shown in Figure 4. Under uniaxial compression, the response of concrete is based on the equations given for non-linear analysis by BS EN 1992-1-1 [10] while in tension the CEB model is used [11]. More specifically, under compression the response is linear until the proportional stress is reached (approximately equal to  $0.4f_c$ , where  $f_c$  is the concrete compressive strength) and then irreversible damage is included in the calculations. Under tension, the stress-strain curve follows a linear elastic relationship until the value of the maximum tensile capacity ( $f_t$ ) after which there is a softening response to compensate for the existence of the embedded reinforcement (as described in [12]) and thus the bond between the two materials. CEB recommends that a stress-strain diagram should be used for uncracked concrete and a stress-crack opening diagram for the cracked section whereas ABAQUS requests the input of a single curve. The stress-crack opening was converted to the softening stress-strain part of the curve using the fracture energy  $G_f$  (energy required to propagate a tensile crack of unit area) divided by the crack band width.



(a)



(b)

Figure 4: Representation of the concrete characteristics in (a) compression and (b) tension

## 4. VALIDATION

Previous studies have investigated the effects of key material and geometric parameters on the ultimate behaviour of floor slabs including the bond strength between steel and concrete as well as the distribution and cross sectional area of steel reinforcement (e.g. [13, 14]). In this section, the experimental results described in Section 2 are used to calibrate and validate the FEM from Section 3. It is noteworthy that although all of the tests have been modelled, only a selection is presented herein owing to space limitations. The presented slabs have been chosen because they illustrate important behavioural characteristics, as will be discussed later.

### 4.1 VISUAL COMPARISON

As shown in Figure 5, the overall response predicted by the models provided a good representation of the experiments. A total of three modes of failure were observed during the experimental programme:

- Tension failure of the steel reinforcement across a localized through-depth crack;
- Compression failure of the concrete in the compressive-ring region close to the supports; and
- Punching failure when the loading plates puncturing through the concrete at large level of deflections.

The cracks developed in accordance with conventional yield line theory. It is noteworthy that the method for applying load during the experimental procedure (Figure 3) was rather complex to control in the numerical model.

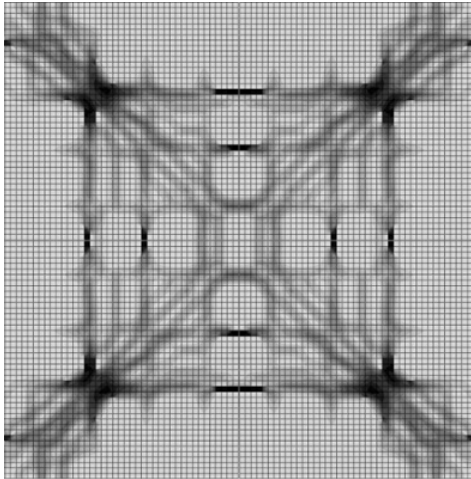

(a)

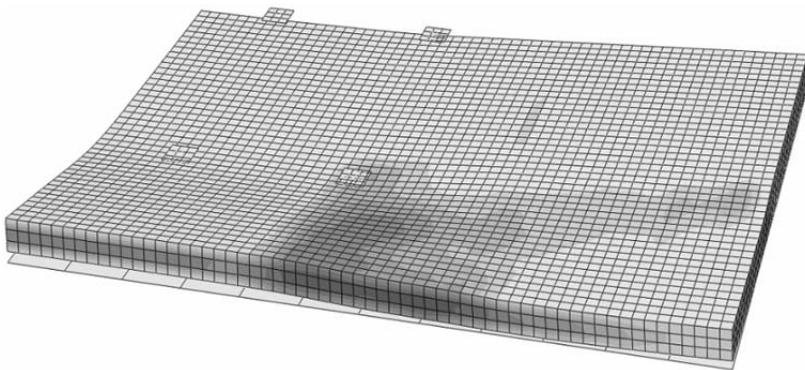

(b)

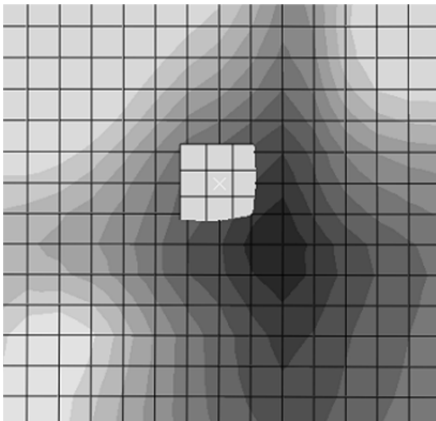

(c)

Figure 5: Images showing (a) the comparison of crack patterns for specimen S-F60-D6-A (b) compression failure of slab S-F60-D6-A and (c) the loading plate puncturing through the concrete for slab S-F60-P6-A

## 4.2 NUMERICAL COMPARISON

The experimental and numerical load-deflection response for slab specimens R-F60-M6-A and R-F60-P6-A are shown in Figure 6a and Figure 6b, respectively. These slabs were selected because they represent both deformed and plain reinforcement which show slightly different results, as discussed later.

Clearly, the overall behaviour of the specimens is well described by the numerical model. It can be seen that first cracking of the concrete, as evidenced by the drop in load at small levels of deflection, is well predicted. Furthermore, yielding of the reinforcing steel is also well simulated with reasonable accuracy until failure. Figure 7 shows the force-displacement of S-F60-M6-A on the main axis while the secondary axis shows the strain induced in the reinforcement along the formed yield line for the corresponding vertical displacement of the slab. The ultimate strain in the reinforcement was obtained by conducting tensile tests [13]

At relatively large levels of deflection, discrepancies can be seen to develop between the experimental and numerical responses for slab R-F60-P6-A (Figure 6b). This is attributed to the low levels of bond strength between the steel and concrete in these specimens, relative to that which develops with deformed bars. Consequently, the response of the model is significantly higher than the tested specimens in large-deflection suggesting that a new material relationship should be considered for representing smooth reinforcing bars.

Other discrepancies in the results are attributed to the effect of the smeared cracked approach associated with the concrete damaged plasticity model which is reliant on the mesh size. Although the crack patterns remain the same regardless of the mesh size, the load capacity is inaccurate if the mesh density is relatively coarse. A mesh sensitivity study has been completed in order to calibrate the elements used in the current work. The local fluctuations in the numerical results are a numerical issue due to the simulation of the interaction between the rigid loading plates and the concrete slab. A finer mesh at the interaction interface would reduce this effect as the distortion of the contact elements would be smaller.

Nevertheless, the results obtained are reliable with this level of noise.

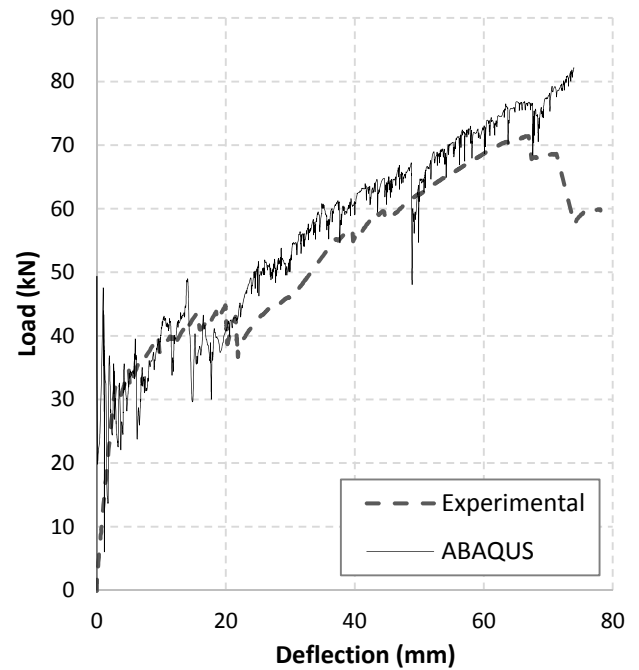

(a)

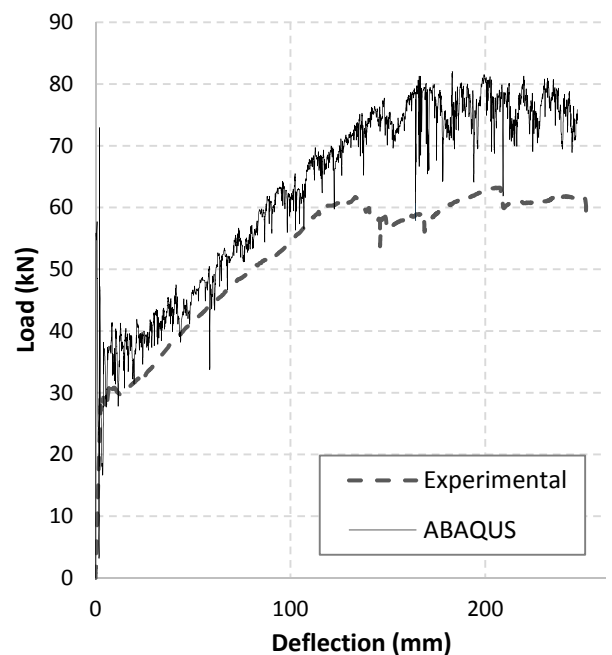

(b)

Figure 6: Experimental and numerical responses for (a) R-F60-M6-A and (b) R-F60-P6-A

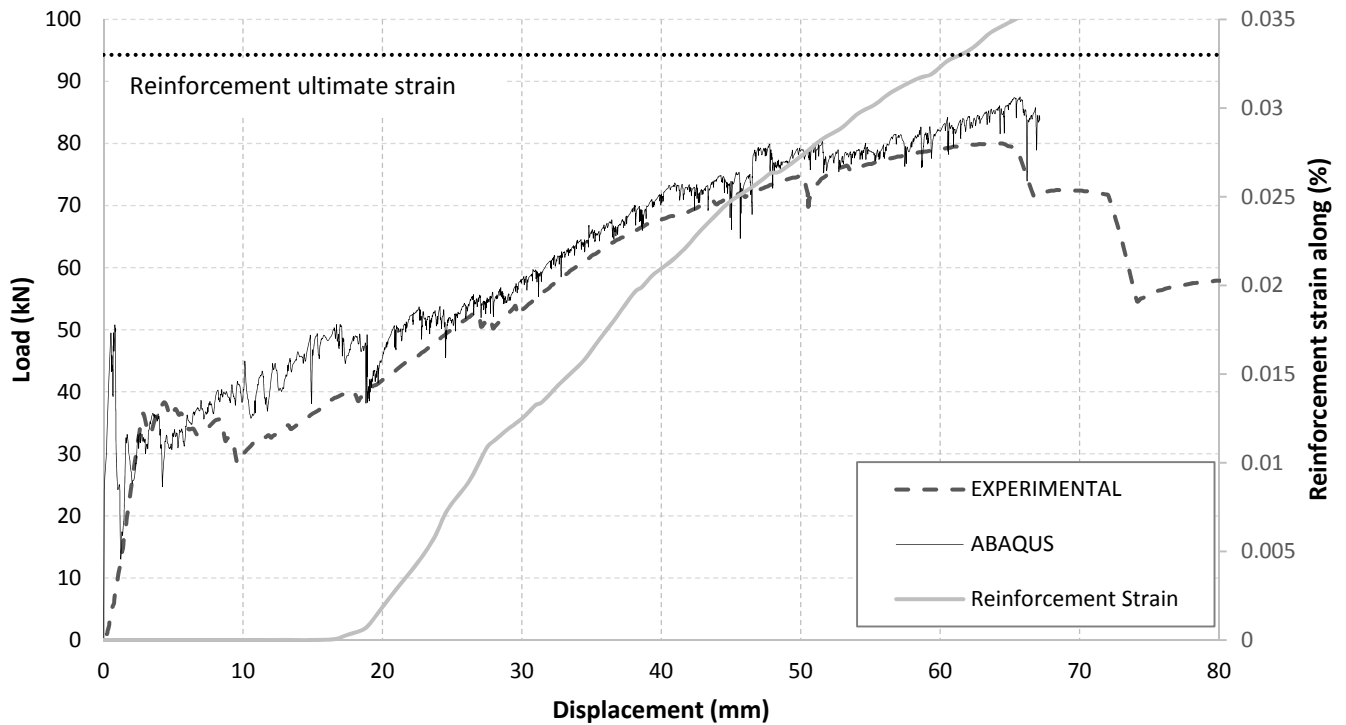

Figure 7: Load-displacement response of S-F60-M6-A with the strain induced in the reinforcement along the formed yield line for the corresponding vertical displacement

## 5. COMPARISON TO OTHER METHODS OF ANALYSIS

In this section, the results achieved above will be compared to those from another commonly used finite element model, VULCAN [4], and also to the BRE analytical method [6]. These approaches will firstly be described before the comparisons are presented.

### 5.1 VULCAN MODEL

VULCAN is a finite element package which was first developed at the University of Sheffield to model the 3-dimensional behaviour of composite steel-framed buildings under fire conditions [4]. It has been extensively validated since its development (e.g. [15]) and has been used herein for two main reasons:

1. To validate the results obtained using the developed ABAQUS model, and
2. To investigate the effects of the loading and boundary condition assumptions made during the experimental and modelling process.

A 9-noded quadrilateral plate element (as shown in Figure 8) was used to model the slab specimens. Each element was divided into 16 layers of which 14 represented the concrete with the remainder used for steel reinforcement. The configuration of the model was an exact replicate of the experimental conditions and a temperature of 20°C was kept throughout the analysis to simulate large-displacement conditions at ambient temperature. More advanced elements are available in VULCAN which are capable of representing the interaction between the steel reinforcement and concrete but these are beyond the scope of the current work. They will be incorporated into future models.

### 5.2 BRE SIMPLIFIED DESIGN METHOD

The BRE simplified design method was first proposed in 2000 [6] in response to the observations at Cardington [1] and other events. This method estimates the load-carrying capacity of a lightly reinforced concrete slab as a function of the vertical displacement based on the in-plane stresses (membrane action) in the slab. The in-plane stress distribution assumed is shown in Figure 9, where the notation is as defined in [6].

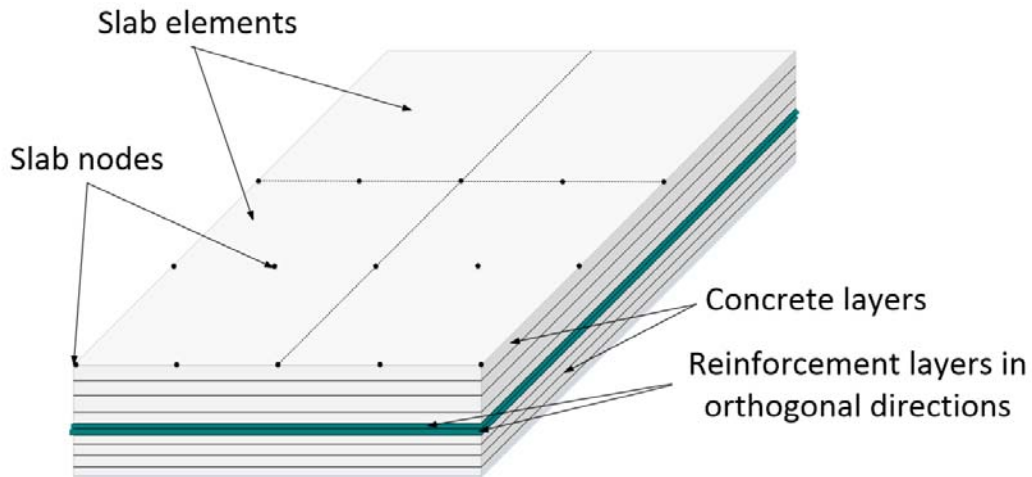

Figure 8: Slab element used for analysis in VULCAN

The method accounts for the influence of tensile membrane action through the determination of the enhancement of the slab's yield-line bending strength. It assumes that deflection continues to take place using the original yield-lines as hinges.

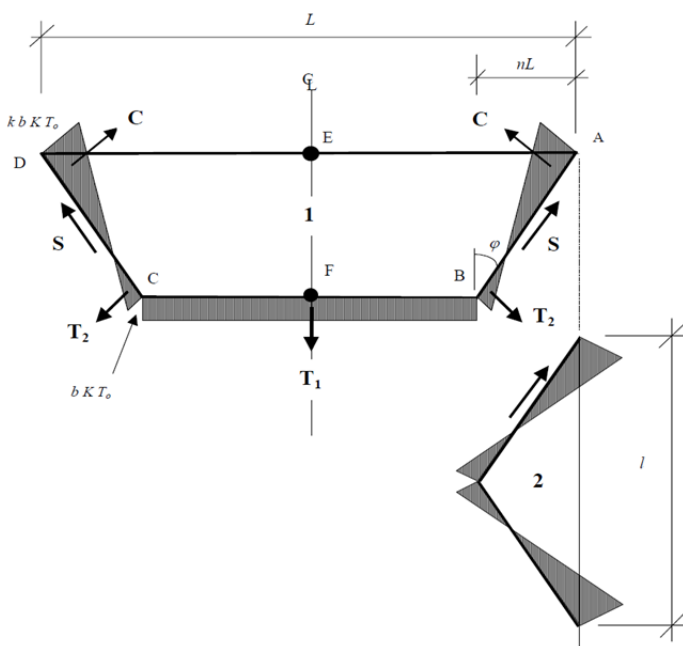

Figure 9: In-plane stress distribution assumed in the BRE method [6]

### 5.3 COMPARATIVE ASSESSMENT

In this section, the slabs S-F60-M6-A and R-F40-M6-B are selected to illustrate the comparison between ABAQUS and VULCAN, as well as the predicted capacity of the slabs using the BRE method. These slabs have been selected for inclusion herein because they indicate behavioural

characteristics which are significant and warrant further discussion.

The results are shown in Figure 10 where it can be seen that not only does the ABAQUS model represent the experimental response with excellent accuracy (as shown before) but also the VULCAN results provide a very good representation of the non-linear behaviour of these slabs. Although only two slabs are presented herein owing to space limitations, the other slabs in this test programme have also been studied and show similarly good results.

It is noteworthy that the VULCAN model only requires 36 elements to simulate the slab with this degree of accuracy. In addition, the absence of clear failure criteria in both models means that the failure deflection and ultimate load capacity cannot be calculated nor compared to the experimental results, without applying some arbitrary maximum value like a limiting deflection. It is clear that although the low-deflection response of the slab is well depicted by the BRE method, as the displacement increases, the prediction deviates increasingly from the experimental response. A maximum enhancement factor of 1.5 times the yield load was calculated for R-F40-M6-B, a value that is considerably lower than the experimental load and the load from both simulated models.

Finally, it is important to comment on the influence that bond strength between the steel and concrete has on the behaviour. This relationship has been shown to be highly influential to the ultimate behaviour of floor slabs [8, 14].



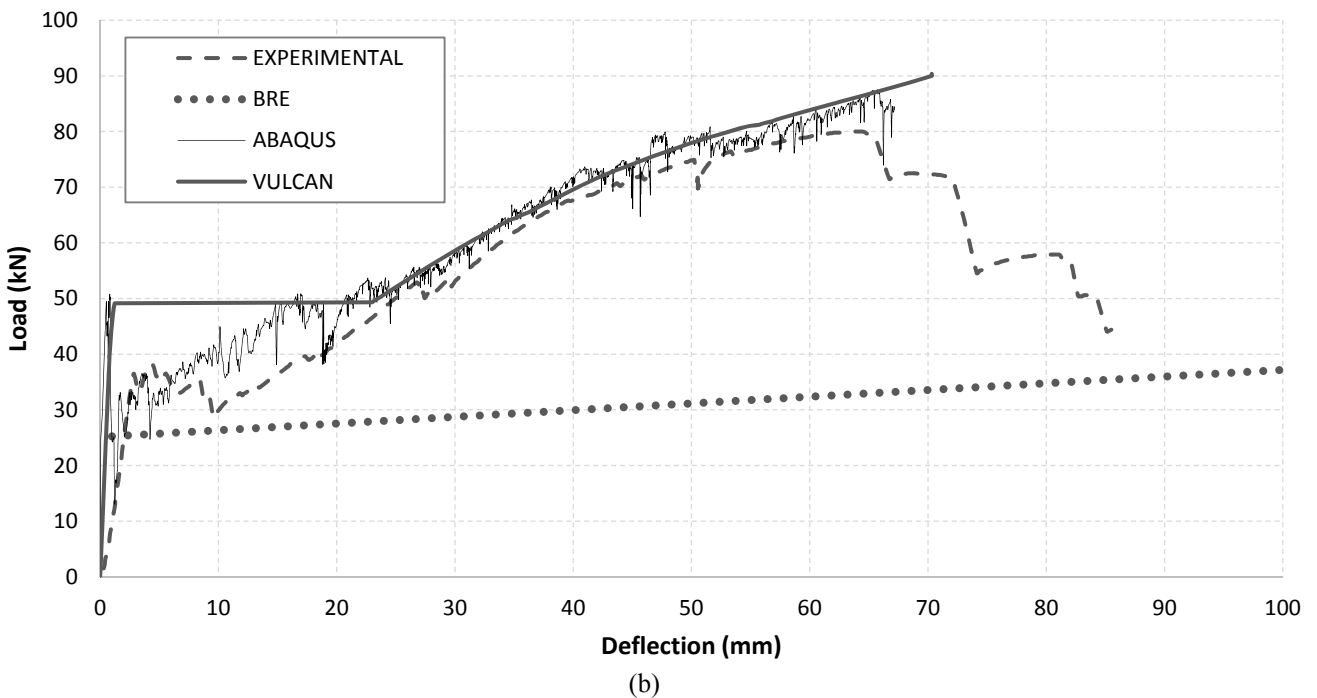
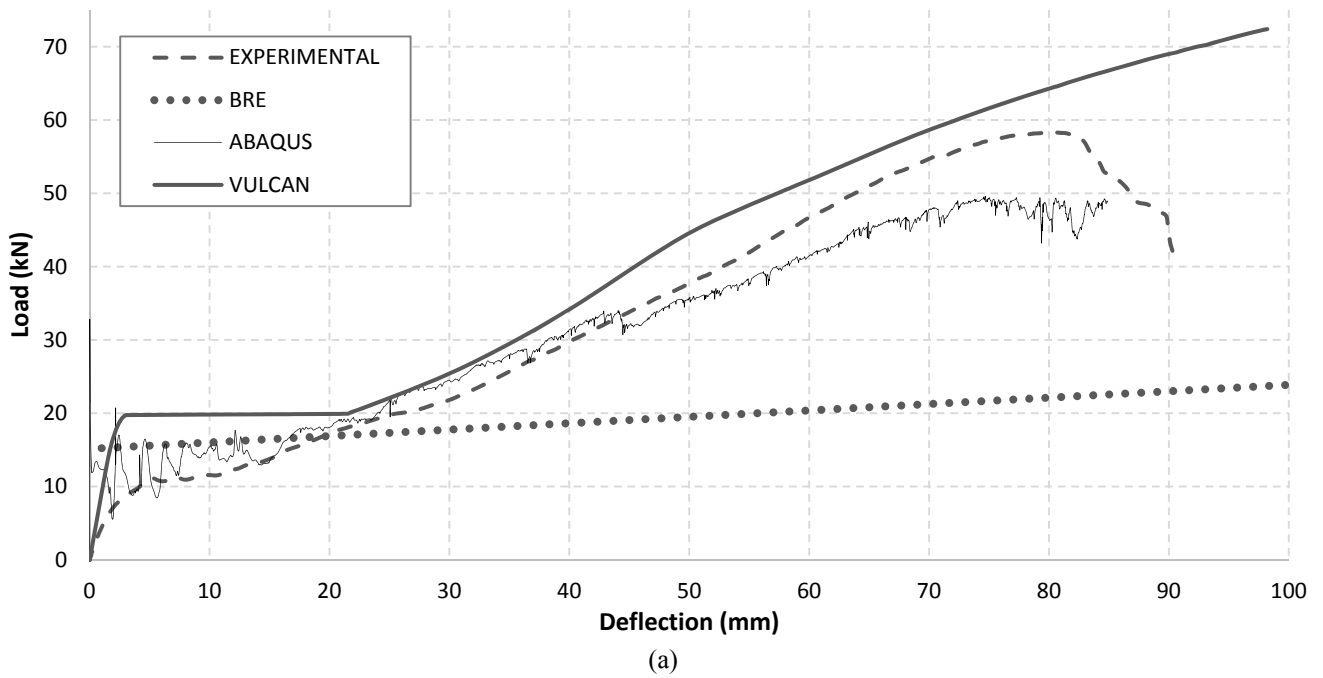

Figure 10: Comparison between experimental and numerical results for (a) S-F60-M6-A and (b) R-F40-M6-B

Finite element modelling without the use of bond elements might be inaccurate under normal circumstances but this can be corrected in the current ABAQUS models by adjusting the tension stress-strain curve to consider the strain-softening of concrete accordingly. However, this requires calibration using experimental data which is clearly limited to certain conditions. It can be seen from the results of R-F40-M6-B that although the reinforcing mesh is the same as that in slab R-F60-M6-A (which was shown in Figure 6a), the

concrete section is smaller and therefore the interaction between the two behaves differently.

## 6. CONCLUSIONS AND FUTURE WORK

In this paper, a numerical model has been developed using the commercially-available ABAQUS software to predict the large displacement behaviour of a lightly reinforced concrete slab. The results have shown that the

developed model can predict the response with good accuracy. Discrepancies and errors in the results have been identified and discussed where appropriate. The work described in this paper is the first step in a larger research programme and the future targets include:

1. Deriving an empirical relationship that describes the stress-strain curve of concrete in tension that can be used in ABAQUS in combination with the concrete damaged plasticity model. This relationship will have to consider for the bar diameter, surface texture (smooth or deformed) and concrete cover;
2. Including the effects of fire on the response through a heat and structural-thermal analysis, including the degradation of material and structural relationships at elevated temperature;
3. Expanding the model to include the influence of neighbouring compartments on the overall behaviour in fire;
4. Using the validated model to develop an understanding of the most salient parameters such as boundary conditions, continuity and various other material and geometric properties under ambient and elevated temperatures on the overall response; and
5. Proposing performance-based expressions which can be used in design for the ultimate response of floor slabs under fire conditions.

The results of this investigation will offer detailed insights into the key factors that govern the ultimate behaviour of buildings with composite floor systems under extreme loading conditions, and provide the essential background to enable the development of more performance-based design expressions.

## REFERENCES

1. BRITISH STEEL, 1999. "The behaviour of multi-storey steel framed buildings in fire." *British Steel, Rotherham, UK*
2. IZZUDDIN, B.A., 1990. "Nonlinear dynamic analysis of framed structures." *Ph.D thesis, Imperial College London.*
3. FRANSSSEN, J.M., 2005. "SAFIR: A thermal/structural program for modelling structures under fire." *AISC Engineering journal*, 42(3), pp. 143-158.
4. HUANG, Z., BURGESS, I.W., and PLANK, R.J., 2003. "Modelling membrane action of concrete slabs in composite buildings in fire. I: Theoretical development." *Journal of structural engineering*, 129(8), pp. 1093-1102.
5. GILLIE, M., USMANI, A. and ROTTER, J.M., 2001. "Modelling of heated composite floor slabs with reference to the Cardington experiments." *Fire safety journal*, 36(8), pp. 745-767.
6. BAILEY, C.G. and MOORE, D.B., 2000. "The structural behaviour of steel frames with composite floor slabs subject to fire: Part 1: Theory." *Structural engineer*, 78(11), pp. 19-27.
7. ABAQUS, 2003. "ABAQUS/Standard user's manual, Vol. I, Version 6.12." *Hibbitt, Karlsson & Sorensen, Inc., Pawtucket, USA.*
8. CASHELL, K.A., ELGHAZOULI, A.Y. and IZZUDDIN, B.A. (2011). "Failure assessment of lightly reinforced floor slabs. I: Experimental investigation." *Journal of structural engineering*, 137(9), pp. 977-988.
9. CASHELL, K.A., ELGHAZOULI, A.Y. and IZZUDDIN, B.A., 2011. "Failure assessment of lightly reinforced floor slabs. II: Analytical studies." *Journal of structural engineering*, 137(9), pp. 989-1001.
10. EN 1992-1-1, 2004. "Eurocode 2: Design of concrete structures. General rules and rules for buildings." *CEN.*
11. CEB-FIP, 1991. "Model Code for Concrete Structures MC90." *Thomas Telford, London.*
12. ELLOBODY, E., 2012. "Composite slim floor stainless steel beam construction exposed to different fires." *Eng. structures*, 36, pp. 1-13.
13. CASHELL, K.A., ELGHAZOULI, A.Y. and IZZUDDIN, B.A., 2010. "Experimental and analytical assessment of ductility in lightly reinforced concrete members." *Eng. structures*, 32(9), pp. 2729-2743.
14. CASHELL, K.A., ELGHAZOULI, A.Y. and IZZUDDIN, B.A., 2012. "Ductility of composite floor slabs under idealised fire conditions." *Proceedings of the ICE - Structures and Buildings*, 165(7), pp. 399-409.
15. YU, C., HUANG, Z., BURGESS, I.W. and PLANK R., 2010. "Development and validation of 3D composite structural elements at elevated temperatures." *Journal of structural engineering*, 136(3), pp. 275-284.