

Investigation and Development of a Framework  
for Medical Waste Management  
in Riyadh, Saudi Arabia

A thesis submitted for the degree of Doctor of Philosophy

by

Abdullah Abdulaziz Alhadlaq

School of Engineering & Design  
Brunel University  
July 2014

## **Acknowledgments**

I would like to express my special thanks and gratitude to my supervisors Professor Wamadeva Balachandran and Dr. Zayed Huneiti for their encouragement, guidance and help throughout this study. Special thanks to my brother Dr. Hisham Alhadlaq, for his help, encouragement and patience. Thanks and appreciation to everyone who helped me to complete this study

# Contents

Acknowledgments.....	i
Contents .....	2
List of Tables .....	7
List of Figures.....	8
List of Abbreviations .....	9
Abstract.....	11
<b>Chapter One: Introduction and Background .....</b>	<b>12</b>
1.1 Medical Waste :Defination and Genreation.....	12
1.2 The framework for HCW.....	15
1.3 Healthcare Services in Riyadh Saudi Arabia .....	15
1.4 Aims and objectives of research .....	16
1.5 Structure of the work .....	18
<b>Chapter Two:Literature Review .....</b>	<b>23</b>
2.1 Healthcare Waste .....	23
2.2 Hospital and Medical Waste .....	25
2.3 Classification of Medical Waste .....	26
2.4 Categories of Medical Waste.....	29
2.5 Regulated Medical Waste .....	31

2.6 The Need of Medical Waste management .....	32
2.7 Monitoring and control of healthcare waste .....	32
2.8 Medical Waste Management in Developed Countries.....	35
2.9 Medical Waste management in developing countries .....	51
2.10 Legal provisions.....	53
2.11 National Regulations .....	53
2.12 Summary of the Chapter .....	53
Chapter Three: Medical Waste Management Technologies and practices .....	55
3.1 waste management practices.....	55
3.1.1 Waste Minimization .....	55
3.1.2 Segregation and Containerization .....	55
3.1.3 Labeling Requirements for Medical Waste Containers .....	56
3.1.4 Storage and Transportation .....	57
3.1.5 Treatment and Final Disposal.....	58
3.2 Medical Waste Treatment Technology used by companies in Saudi Arabia .....	<b>Error!</b>
<b>Bookmark not defined.</b>	
3.3 Alternative Technologies to Incineration for Clinical Waste .....	61
3.3.1 Plasma Technology .....	61
3.3.2 Plasma Gasification for Waste management .....	63
3.3.3 Plasma Furnace for the treatment and disposal of Biomedical.....	64

3.3.4 Plasma Furnace Process .....	65
3.3.5 Afterburning Chamber.....	66
3.4 Advantages and Disadvantages of Plasma Technology .....	67
3.5 Summary of the Chapter .....	69
<b>Chapter Four:Research Methodology</b> .....	<b>72</b>
4.1 Hospitals Survey .....	72
4.2. Developing a Research Questionnaire .....	72
4.2.1 Section A: General Information.....	73
4.2.2 Section B: Activity Measurement.....	73
4.2.3 Section C: Status of Waste Generated & Segregation.....	74
4.2.4 Section D: Treatment Technologies, Transportation and Disposal of Waste.....	74
4.2.5 Section E: Regulations and Recommendations .....	74
4.3 Quantitative Questionair for Medical Staff.....	74
4.4 Methodological Approach for Development of frame work .....	74
4.5 Piloting, Data Collection and Analysis .....	76
4.6 Summary of chapter .....	76
<b>Chapter Five: Hospital Survey</b> .....	<b>77</b>
5.1 Current status of facilities in health care units.....	77
5.2 Survey Sample .....	77
5.3 Findings.....	80

5.3.1 Activity Measurement.....	80
5.3.2 Waste Generation.....	82
5.3.3 Type of Waste Generation .....	88
5.3.4 Waste Segregation .....	93
5.3.5 Handling.....	96
5.3.6 Waste storage .....	96
5.3.7 Treatment and Disposal of Healthcare Waste.....	97
5.4 Medical waste Treatment Technologies Used by Companies .....	99
5.5 Cost of disposal of medical waste.....	100
5.6 Summary of Chapter .....	103
<b>Chapter Six: Medical Staff Preparedness and Attitude towards Medical Waste</b>	
<b>Management .....</b>	<b>.104</b>
6.1 Sample.....	104
6.2 Data Analysis and Findings .....	106
6.3 Summary of Chapter .....	112
<b>Chapter Seven: Frame Work for The Medical Waste Management in Riyadh city</b>	
7.1 The Inclusion of Islamic Principals .....	113
7.2 Addressing Major Issues from Previous Tasks.....	113
7.3 The Framework.....	114
7.4 Framework Evaluation.....	116

7.5 Data Analysis and Findings .....	
7.6 Summary of Chapter .....	119
<b>Chapter Eight: Conclusions, Limitations, and Recommendations for Future Work.....</b>	<b>120</b>
8.1 Conclusions.....	120
8.2 Limitations .....	122
8.3 Recommendations for Further Work .....	122
<b>References .....</b>	<b>Error! Bookmark not defined.</b>

## List of Tables

Table 1.1	Type of health care percentage in Riyadh city	15
Table 2.1	Categories of hospital waste according to WHO	32
Table 5.1	No. of outpatients per month in government hospitals	96
Table 5.2	Number of outpatients per month in private hospitals	97
Table 5.3	Quantities of waste generated by per government hospitals	101
Table 5.4	Quantities of waste generated by per private hospitals	102
Table 5.5	Wards that generate the most medical waste in government hospital	107
Table 5.6	Wards that generate the medical waste in private hospitals	108
Table 5.7	segregation of medical waste	109
Table 5.8	Transporter for medical waste in government hospital	116
Table 5.9	Transporter for medical waste in private hospital	117
Table 5.10	cost of medical waste treatment per year in government hospital	120
Table 5.11	cost of medical waste treatment per year in private hospital b) Graphical illustration of cost	121
Table 6.1	Participated Hospitals	123
Table 6.2	Participated Hospitals Departments	124
Table 6.3	Participates Qualifications	124
Table 6.4	Participates Country of Graduation	124
Table 6.5	Year of Graduation	125
Table 6.6	Medical staff Degree of Concern in relation with Medical Waste	126
Table 6.7	Descriptive Analysis	126
Table 6.8	Significance of Variance between participated Group	128
Table 6.9	Summary for Multiple Comparisons Test	129
Table 7.1	Descriptive Analysis	135
Table 7.2	Significance of Variance between participated groups	136



## List of Figures

---

Figure 1.1	location map of health care centres in Riyadh city	116
Figure 2.1	Classification of waste by WHO	28
Figure 2.2	Classification of waste by EPA, USA	31
Figure 2.3	A time-line of national legal and regulatory framework for waste management	37
Figure 2.4	Comparison of waste management laws and compliance levels for European Community countries	38
Figure 3.1	Collection containers with different colour coding and labelling	65
Figure 3.1	Medical waste treatment steps	69
Figure 3.2	Comparisons of treatment technologies in terms of waste volume reduction operating charges and capital costs	70
Figure. 3.3	(a) Plasma based medical waste management system (b) Process of treatment	77
Figure 3.4	Use of plasma for toxic municipal waste	78
Figure 3.5	(a) Plasma arc torch PPT-100AC with a power of 100kW (b) Design details of plasma arc torch	79
Figure 3.6	A complete plasma based medical waste treatment system	80
Figure 4.1	Research Methodology	85
Figure 4.2	Sections of Questionnaire developed for survey	88
Figure 4.3	Preparedness and Attitude interview structure	90
Figure 4.4	Methodological Approach for the Design of Framework	91
Figure 4.5	Quantity of general and medical wastes generated in government hospitals	97
Figure 5.1	Quantity of general and medical wastes generated in private hospitals	98
Figure 5.2	Percentage of medical waste generated in hospitals	99
Figure 5.3	Types of medical waste for government hospitals	104
Figure 5.4	Types of medical waste for private hospitals	105
Figure 7.1	The Proposed Strategy Framework	133
Figure 7.2	Addressing the Key Requirements	134

## **List of Abbreviations**

---

**AIDS** : Acquired Immune Deficiency Syndrome

**EMS** : Emergency Medical Services

**EQA** : Environmental Quality Authority

**GMW**: Generated Medical Waste

**GP**: General Practitioner

**gr**: gram

**HCFs**: Health Care Facilities

**HCW**: Health Care Waste

**HCWH**: Health Care Waste without Harem

**HCWM**: Health Care Waste Management

**HIV**: Human Immunodeficiency Virus

**IPCP**: Infection Prevention and Control Protocols

**MCH**: Mother Child Hood

**MOH**: Ministry of Health

**MW**: Medical Waste

**NGOs:** Non-Governmental Organizations

**OPD:** Out Patient Department

**PHCs:** Primary Health Care Centers

**Pr.C :** Private Clinics

**SPSS:** Statistical Package for Social Science

**THU:** Target Healthcare Units

**UNRWA:** United Nations Relief and Works Agency

**WHO:** World Health Organization

**JCAHO:** The Joint Commission on Accreditation of Healthcare Organizations

**AHA:** American Hospital Association

**ATSDR:** The Agency for Toxic Substances and Disease Registry

## **Abstract**

The Kingdom of Saudi Arabia is the largest country in the Gulf states and one of the richest oil producing countries. Saudi population is nearly 27 million; in addition, Saudi Arabia receives millions of people from around the world for Islamic pilgrimages. Moreover, Saudi is hosting hundreds of thousands of international professionals and labourers. Hence, the country infrastructure and services have been in the top agenda to be modernized in order to cope with new demand for better quality of life for a rich country. The healthcare sector is one of the key sectors which requires a special ongoing attention, particularly medically generated waste. Therefore, this research work has been conducted to investigate the status of medical waste management in the capital city; Riyadh. The prime aim of this research work is to propose a strategic framework which can be used as a roadmap for the different stakeholders. This will contribute to the enforcement of better handling and treatment of medical waste and more importantly prevent and control the spread of diseases or harm that might be caused by poor handling of medical waste.

The aim of the research has been achieved through; the critical review and analysis of the relevant literature, which has revealed the noticeable gap and lack of scientific studies of the proposed field. Appropriately, the findings of the research have contributed to filling the gap of the knowledge as well as serving as a milestone for further research work in this very important field. By surveying Riyadh's hospitals and other national and international reports has. This allowed the presentation of the facts and indications of the current status of medical waste in Riyadh City. To obtain in-depth knowledge and gather the important findings concerning the medical waste management, focused; interviews of different medical professionals from various hospitals were conducted. This research has revealed more important factors that need to be addressed. These findings were used to propose the framework, which has been formed to enable resolving the challenges of the integration, of the awareness element through Islamic principles, within the Saudi system. The proposed framework has been evaluated by committee of medical

professionals and has been accepted as good roadmap and appropriate solution that address the main aim of this research work.

Finally, the research work is just a step towards the establishment of a proper biomedical waste management system in the Kingdom of Saudi Arabia. Some recommendations for future implementation are suggested at the end of this thesis.

# Chapter 1: Introduction and Background

---

The establishment of a healthcare system is a basic requirement of every civilized society. Food, medicines, chemicals, equipment and instruments are used while treating out patients as well as patients admitted into hospital, naturally, this leads to the production of a variety of medical and non-medical wastes. Appropriate management and minimization efforts are necessary to reduce the quantity and volume of these types of waste, as well as to reduce handling and disposal expenses. Although significant progress has been made in healthcare waste management, existing healthcare waste management practices in Saudi Arabia still need a great deal of modifications and improvement.

## **1.1 Medical Waste: Definition and Generation**

Throughout the world medicine is one of the sectors that have witnessed significant developments. According to world health organization report (Prüss et al. 2013), the term medical waste is alternatively known as clinical waste. Generally, healthcare waste has been classified as clinical waste and legally this definition has not changed. However, there is a need to classify healthcare waste within the clinical waste stream, based on its hazardous characteristics and point of production. In practice, arrangements for managing clinical waste are based on the categorization of waste into groups which present different hazards (Cheng et al. 2009). Healthcare waste includes all the waste generated by healthcare establishments, research facilities, and laboratories. In addition, it includes the waste originating from “minor” or “scattered” sources - such as that produced in the course of healthcare undertaken in the home (dialysis, insulin injections, etc.).

The wastes generated from the treatment of patients suffering from infectious diseases may spread infection either through direct contact or indirectly through the environment (Cheng et al. 2009, Hossain et al. 2011a). Globally, this issue has been seriously considered and appropriate waste-management systems are being developed and implemented. Consequently, waste management and the pollution problems associated with waste generation have attracted

significant attention and a great deal of research has been conducted on these issues (Babanyara 2013). Infectious waste materials need to be handled with care to prevent the spread of pathogens and to protect environmental health; they should be segregated from other waste materials.

The amount of medical waste produced by hospitals may vary due to a number of factors including hospital type and size; occupancy rate; in- and out-patient ratio; geographic location; state and local waste-handling regulations; and hospital waste-disposal policies.

As healthcare costs escalate, hospitals must constantly examine all aspects of their operations to stay within their budgets. Disposal of regulated medical waste is a major expense, and medical facilities continue to seek cost-effective solutions to the medical waste problem (Bartley, Olmsted & Haas 2010, Budd, Baker 2013, Cheng et al. 2009). A major obstacle in cutting costs is the lack of a universally accepted definition of infectious waste. Regulatory authorities and individual institutions in some US states and in other countries have concluded that very little medical waste is truly infectious; and narrower definitions are being adopted as to what constitutes infectious waste. Studies have demonstrated that medical waste poses virtually no infectious hazard to the public (Manyele 2004). However, rates of generation of infectious waste per patient per day still vary considerably because of this lack of consensus on definitions. The generation of medical wastes will continue to be an on-going phenomenon as long as human civilization persists. This type of waste carries a higher potential for infection and injury than any other type of waste. Medical waste management is of immense importance because of the potential environmental hazards and public health risks it poses (Cheng et al. 2009). Consequently, there has been increased public concern about the management of healthcare waste in recent years. Proper handling, segregation, mutilation, disinfection, storage, transportation and final disposal procedures are crucial for safe and scientific management of medical waste.

Most of studies reported that US hospitals generate between 2 to 4 lb. of infectious waste per patient per day, or about 15% of the total hospital waste stream (Berwick, Hackbarth 2012). Regardless of the definition used, all hospitals can benefit by reducing the amount of material entering the infectious waste stream through better waste segregation and management of its disposal.

## **1.2 Framework for Healthcare Waste**

The absence of well-defined waste-management policies and guidelines, lack of awareness about the health hazards, insufficient financial and human resources and poor control of waste disposal are the most common problems associated with healthcare wastes (HCW). Many countries including Saudi Arabia do not have appropriate regulations for healthcare waste. An essential issue is the clear attribution of responsibility of appropriate handling and disposal of waste. According to the 'polluter pays' principle, this is the responsibility of waste producer to take measures for proper disposal of waste (Budd, Baker 2013). In general, the healthcare provider, or the establishment involved in waste management processes. The flow of hazardous healthcare waste should be well controlled from the sources of generation to the final treatment.

Due to increasing private sector involvement in waste-management activities, it is important to have established laws and regulations on all aspects of waste management (worker safety, adoption of segregation, transportation, treatment, and disposal). Increasingly, national ministries are providing an oversight service including the monitoring and evaluation of services, emissions, and waste characterization.

The goal of healthcare is to reduce health problems and protect the public from health risks. In addition, the healthcare industries could play a significant role in the economic development of a country (Harhay et al. 2009). They generate job opportunities for the unemployed, on the one hand, and safeguard and maintain the health, safety and wellbeing of the work force, on the other hand. However, these industries generate waste that is potentially harmful to public health and the environment.

The presence or absence of waste management policy, level of economic development, size of individual healthcare facility, types of medical specialties practiced, etc. govern the amount and type of waste generated in a country. According to (Lu, Chang & Liao 2012, Pichtel 2010a), high-income countries generate up to 6 kg of hazardous waste per person per year and in the majority of low-income countries, the total healthcare waste per person per year is from 0.5 to 3 kg. In contrast the estimated daily production of solid waste by rural hospitals in Sub-Saharan Africa ranges between 0.3 and 1.5kg per bed, of which 2- 10% is estimated to be hazardous and this figure for industrialized countries is 3-6 kg and 5-20%, respectively. Waste from healthcare activities can cause diseases as well as serious environmental problems in terms of air, water and



soil pollution whenever handled improperly. Improper practices such as the disposing of medical waste in municipal dust bins, open spaces, water resources, etc. can lead to the spread of diseases (Manyele 2004). Staff and patients in healthcare establishments, workers in waste treatment and disposal facilities and the community at large are at risk of exposure to health hazards associated with healthcare waste.

The establishment of laws and regulations on all aspects of Health Care Waste Management (HCWM) is the foundation of regulating and enforcing proper practices in any country. The National Constitution should be completed by a policy document and national guidelines. Policy document on HCWM should outline the rationale for legislation as well as the goals and the essential key steps to achieve these goals. National guidelines associated with the legislation should be practical and directly applicable. They should include the minimum obligatory procedures for the safe management of HCW. The establishment of a precise, strong and comprehensive legislation related to the management of HCW is a crucial point. Central, regional and municipal governments should establish a specific law that would aim at providing acceptable framework in which HCW should be managed, treated and disposed of. It is actually essential that the Government pass a law that provide the minimal administrative and management requirements that should be respected and followed within the country. Considering the difficulties that certain countries are confronted with regarding the enforcement of legislation, the public health and environmental goals that should be achieved can be met to a great extent through training and awareness campaigns on TV, radio, public seminars, schools and universities which highlights the risks to each and every one when HCW is mismanaged and the ways to minimize them.

### **1.3 Healthcare Services in Saudi Arabia**

The healthcare in Saudi Arabia is free for all native citizens and for foreigners needs to register for the health services provided by hospitals and medical centres (Almalki, Fitzgerald & Clark 2011). Some of Saudi nationals use private hospitals and pay for their treatment in order to avoid the long waiting time for appointments and to have a good medical care which is in some cases not available in government hospitals. The largest numbers of hospitals in Riyadh city (capital city), which is the capital of the Kingdom of Saudi Arabia, are government hospitals. It has a

population of more than 4.5 million with a growth rate of about 8% annually (Al-Ansary, Khoja 2002, Memish, Al-Rabeeah 2013).

Riyadh is witnessing an increase in the number of people travelling from all over the Kingdom to benefit from the high quality healthcare services and the establishment of small & medium size clinics (Neyaz et al. 2011a). This has resulted in an increase in the amount and type of medical/biomedical waste. Medical/biomedical waste is any waste generated in the course of healthcare activities such as the diagnosis, maternity, treatment or immunization of human beings or in research activities that may include humans or animals (Gautam, Thapar & Sharma 2010, Harhay et al. 2009).

Ministry of health in Saudi Arabia indicates that there were 362 healthcare units in the Riyadh city (Neyaz et al. 2011b). The distribution of these health care services is breakdown into various types of facilities, namely government and private hospitals, primary healthcare centres and others (See Table1.1).

Type of health care	No.	Percentage %
Government hospitals	22	6.0
Private hospitals	18	3.6
Primary health care	87	24.0
Private clinics	186	51.4
Dental clinics	48	13.3
Red crescent	6	1.7
Total	362	100%

Table 1.1 Type of provision in Riyadh health care city (Neyaz et al. 2011b)

The majority of health care services are located in the centre and in the eastern region of Riyadh city. The total number of physicians is 2527 and the total numbers of beds available in these medical centres are 7296 (Mahmoud, Abdalla 2013).

Figure 1.1 illustrates the map which explains the locations of all governments and privates hospitals and health centres in Riyadh city.

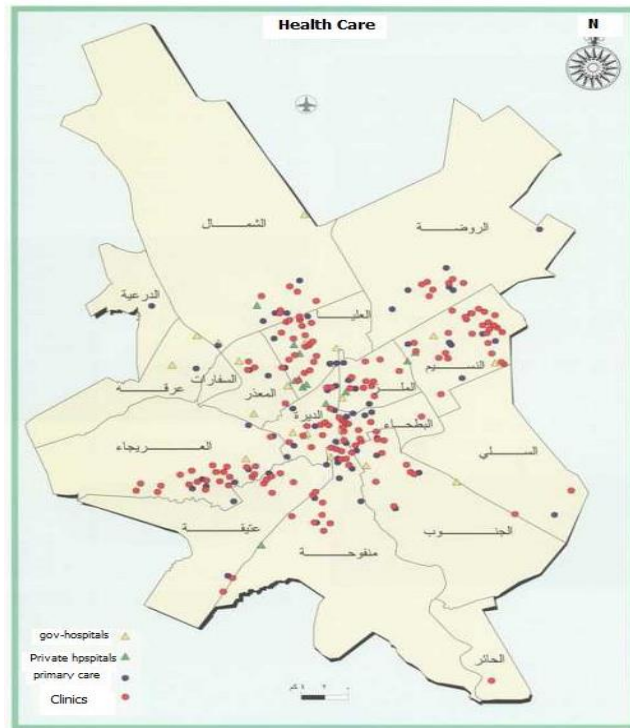

Figure 1.1: Location map of health care centres Riyadh city (Mahmoud, Abdalla 2013)

## 1.4 Aims and Objectives of Research

The aims of this study are:

- To collect and analyze information on existing handling, treatment, and disposal practices of medical waste generated by hospitals in Riyadh, Saudi Arabia.
- To design and test a comprehensive framework for HCWM to propose it as a roadmap for future medical waste management in Riyadh hospitals.
- To provide an understanding of today's good practice guidance for arranging the collections and treatments of clinical waste from businesses.
- To provide knowledge and best practice of the actions required to arrange and carryout safe clinical waste collections.

- To provide an understanding of the hazards and risk's that may be present when arranging clinical waste collection services.
- To provide knowledge of the control measures required to manage the risk's that may be present when completing clinical waste collections.
- To provide knowledge of the actions required to support the prevention of accidents and avoid the spread of infection when arranging and completing clinical waste collections.

The above aims have been achieved through the following objectives:

1. To raise awareness of the legislation that governs the way hazardous waste is managed.
2. To identify and discuss the potential hazards and risks that may be present when arranging medical waste collections.
3. To provide an understanding of employers and employees' responsibilities within the local laws and regulations.
4. To raise awareness of actions among health centers' administrators and staff, which may constitute a breach of the local laws and regulations.
5. To evaluate the collection and disposal methods and To determine the types of waste generated in various hospitals in Riyadh city
6. To assess and compare the volume and quantity of waste generated in government and Private Hospitals.
7. To assess the knowledge on WHO hospital waste management guidelines and the level of training given to hospital waste handlers.
8. To make recommendations for effective hospital waste management in Riyadh hospitals.
9. To Design and propose a framework for a future HCWM system after the identification of relevant factors in hospitals of Riyadh city.
10. To identify the role of religion and higher education in Saudi society for adopting and implementing the proposed HCWM framework.

## 1.5 Structure of the Work

The structure of thesis is divided into seven chapters as illustrated in Figure 1.2.

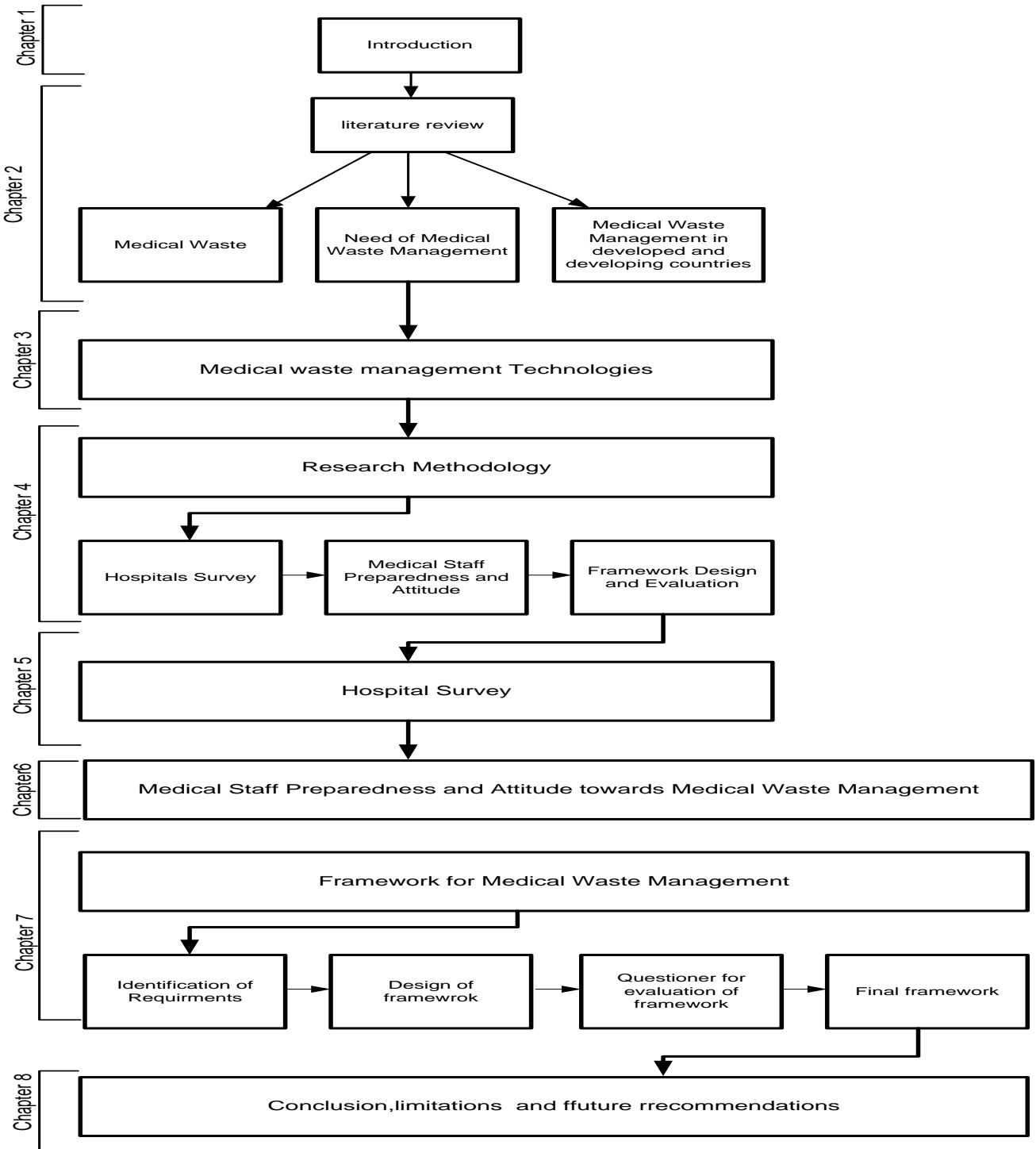

**Figure 1.2:** Structure of the Thesis

### ***Chapter Two: Literature Review:***

A literature review of the healthcare medical waste is presented in this chapter with focus on the need of proper waste management in the healthcare sector. Furthermore, a review of the policies for medical waste management in both developed and developing countries has been presented.

### ***Chapter Three: Medical Waste Management Practices and Technologies:***

The focus of this chapter is to review and discuss the available medical waste management practices and technologies, which have been applied in KSA medical sector.

### ***Chapter Four: Research Methodology:***

In this chapter, an introduction to research methodology used, and the reasons for using such methods in the current research, is presented. Each step of the research work is illustrated and fully explained.

### ***Chapter Five: Hospitals Survey and Corresponding Waste Management:***

The analysis of data collected from hospitals and related sources on aspects of medical waste are detailed in this chapter.

### ***Chapter Six: Medical Staff Preparedness and Attitude towards Medical Waste Management***

This chapter presents the findings of the study, which has been conducted on Saudi hospitals to assess medical staff readiness and attitude towards medical waste management.

### ***Chapter Seven: Framework for Medical Waste Management in Riyadh city:***

A step by step development of framework which was proposed for medical waste management in Riyadh city has been presented and each component of the proposed framework is discussed in detail.

***Chapter Eight: Conclusions and Recommendation for Further Work:***

This is the last chapter of the thesis where the conclusions drawn from the research, are presented. Limitations of the work done are also discussed. Final section presents some recommendations for further work.

# Chapter 2: Literature Review

---

In this chapter, initially a detailed background of healthcare/medical waste is presented. The literature review of healthcare waste, healthcare waste regulations policies in both developed and developing countries is reviewed. The literature is collected from books, research publications, reports from healthcare organisations and online resources.

## 2.1 Healthcare Waste

Healthcare waste (HCW) can be defined as the total waste stream that is generated from the healthcare establishments, health related research facilities, laboratories and emergency relief donations. Hospitals, clinics, laboratories, medical research centres, pharmaceutical manufacturing plants, pharmacies, blood banks, veterinary healthcare centres and home healthcare activities are some of the generators of healthcare waste.

Waste generated from healthcare activities can be broadly categorised as general waste and hazardous waste (Pichtel 2010b). The major portion of waste generated in healthcare activities is comprised of general waste that can be treated in the same way as domestic waste. However, this remains true only when proper segregation and separation of waste is practiced according to the type at the source. There are different estimates regarding the share of hazardous and non-hazardous constituents of healthcare waste. (Komilis, Fouki & Papadopoulos 2012a) and (Sharma et al. 2013) estimated that between 75% and 90% of the waste produced by healthcare facilities is general waste comparable to domestic waste. In addition (Kumar et al. 2011) reported that 85% of the waste produced in hospitals and clinics is non-contaminated and poses no risk of infection. On the other hand, (Komilis, Fouki & Papadopoulos 2012b) stated that from the total waste generated by healthcare activities, 80% is general waste and the balance is considered as hazardous, as it tends to be infectious, toxic or radioactive.

A definition of hazardous waste was established for the first time in the USA at the beginning of the 1980s. It encompasses all substances that are hazardous to human health and the environment (New York State Department of Health, 1991). It was found from the audit that around 90% of



hospital waste was general waste, similar in properties to domestic waste. The remaining 10% was infectious hazardous wastes. Budd and Baker (2013) found that 10–25% of healthcare wastes were termed as infectious; this includes pharmaceutical, radioactive and chemical wastes which may produce a variety of health and environmental risks.

In contrast, medical waste, infectious waste, and regulated medical waste are all subsets of hospital waste. Medical waste is defined in Section 3 of the Medical Waste Tracking Act of 1988. The Medical Waste Tracking Act of 1988 is a United States federal law that addressed the handling and disposal of medical waste in coastal areas (Pichtel 2010a). The law created a two year program that went into effect in New York, New Jersey, Connecticut, Rhode Island and Puerto Rico on June 24, 1989, and expired on June 21, 1991. In that law the medical waste is explained as:

“any solid waste that is generated in the diagnosis, treatment, or immunization of human beings or animals, in research pertaining thereto, or in the production or testing of biological”

It is important to point out that the term ‘medical waste’ has often been used interchangeably with other terms such as ‘hospital waste’ and ‘infectious waste’ around the world.

The terminology applied to medical waste and medical waste management in hospitals is neither universal nor consistent. The Centre for Disease Control (CDC), the Environmental Protection Agency (EPA), the Joint Commission on Accreditation of Healthcare Organizations (JCAHO), the American Hospital Association (AHA), and the Agency for Toxic Substances and Disease Registry (ATSDR) all have different definitions for “hospital,” “medical,” “infectious,” and “regulated medical” wastes (Komilis, Fouki & Papadopoulos 2012b, Budd, Baker 2013, Rastogi, Rastogi & Bhatia 2011).

As one of the aims of this study is to collect information on existing handling, treatment, and disposal practices of medical waste generated by hospitals in Riyadh city, the research in this chapter goes through various types of waste from several healthcare facilities and the different

technologies that are used to treat them as a way to compare the current state of the waste management in KSA with other systems around the world. That would include the developing and developed countries in order to include all the gaps that should be taken into consideration to create a supportive platform for the designed framework. The surveyed practices and technologies should provide insights for proposing several solution strategies such as state-of-art technologies, education and training, culture side, law role, monitoring and control, and investments.

As all those strategies are included in the design, this chapter investigates the waste management in different cultures and the different technologies that are used for several types of wastes that are produced in KSA and around the world, for the purpose of collection and comparison. This chapter investigates several technologies to provide knowledge of the actions required to arrange and carryout safe clinical waste collections, and to support the research framework in understanding the hazards and risks that may be present when managing clinical waste collection services.

## **2.2 Hospital and Medical Waste**

In general, hospital waste refers to all waste generated by hospitals including infectious and non-infectious waste materials, hazardous wastes and chemicals, biological and non-biological that is discarded and not intended for further use. It consists of infectious and non-infectious solid waste, hazardous waste, and low-level radioactive waste.

Medical waste is often considered to be a subcategory of hospital waste and indicates ‘potentially’ infectious waste that is produced from healthcare facilities (Komilis, Katsafaros 2011, Komilis, Fouki & Papadopoulos 2012a). Radioactive materials that have been used in medical examination and activities in a hospital setting (e.g. ray examination laboratory, X-ray treatment room) should be properly stored, transported, and treated to avoid any environmental and health hazards via beta and gamma ray emissions.

The type of waste generated in hospitals is generally categorised as (Hossain et al. 2011b):

- Cultures and stocks of infectious agents and associated biological.
- Human blood and blood products.

- Pathological wastes.
- Contaminated sharps.
- Contaminated animal carcasses, body parts and bedding.
- Wastes from surgery and autopsy.
- Contaminated laboratory wastes.
- Dialysis unit wastes.
- Contaminated equipment.

### 2.3 Classification of Medical Waste

Medical waste includes both non-hazardous and hazardous waste constituents. The non-hazardous waste includes wool, kitchen wastes, etc., that does not pose any special handling problem or hazard to health or the environment (Mohan, Prasad & Kumar 2012). Non-hazardous waste is generated in the patients’ ward areas, out-patient-department (OPD), kitchens, offices, etc. (Cheng et al. 2009). The hazardous waste portion includes pathological, infectious sharps and chemical wastes. Hazardous wastes are normally produced in labour wards, operation theatres, laboratories, etc.

According to WHO the 10-25% hazardous fractions of total HCW are usually classified into the following waste groups, Figure 2.1.

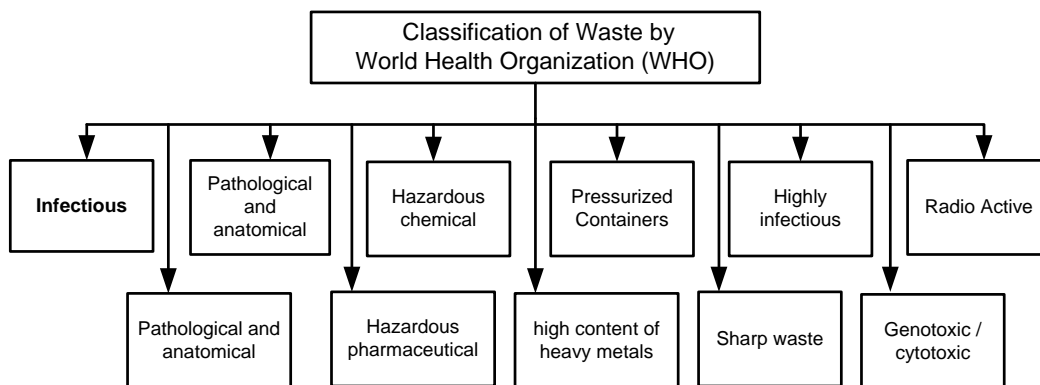

Figure 2.1: Classification of waste by WHO (Prüss et al. 2000)

#### **a) Infectious**

All wastes suspected to contain pathogens in sufficient quantities to cause diseases to other host or person. It includes discarded materials or equipment used for the diagnosis, treatment and prevention of disease as dressings, swabs, and others. This group also includes liquid waste such as urine, blood and sputum or lung secretions (WHO, 1999).

#### **b) Pathological and anatomical**

Pathological waste consists of organs, tissues, body parts or fluids such as blood. Anatomical waste is a sub-group of pathological waste and consisting of recognizable human body parts (Pichtel 2010a).

#### **c) Hazardous pharmaceutical**

Pharmaceutical waste includes expired, unused, spilt and contaminated pharmaceutical products, drugs and vaccines (Schwartz et al. 2010).

#### **d) Hazardous chemical**

Chemical waste consisting of discarded chemicals (solid, liquid or gaseous) that are generated during disinfecting procedures or cleaning processes (Lancaster 2010).

#### **e) High content of heavy metals**

Wastes with high contents of heavy metals are highly toxic such as cadmium or mercury from thermometers or manometer (Fu, Wang 2011). They are considered as a sub-group of chemical waste but they should be treated specifically

#### **f) Pressurized containers**

It consists of full or empty containers or aerosol cans with pressurized liquids, gas or powdered materials (Mathur 2014).

#### **g) Sharp waste**

Sharps are items that can cause cuts or puncture wounds, needle stick injuries for instance (Prem Ananth, Prashanthini & Visvanathan 2010). They are considered to be highly hazardous instrument and potentially infectious waste.

**h) Highly infectious**

They include body fluids of patients with highly infectious diseases, microbial cultures and stocks of highly infectious agents from Medical Analysis Laboratories (Pant 2012).

**i) Genotoxic / cytotoxic**

Genotoxic waste derived from drugs that are generally used in oncology or radiotherapy units that have a high hazardous mutagenic or cytotoxic effect, vomit or urine from patients treated with cytotoxic drugs or chemicals should be considered as genotoxic (Prüss et al. 2013).

**k) Radioactive**

Radioactive waste includes gas, liquids and solids contaminated with radio-nuclides whose ionizing radiations have genotoxic effects (Demirbas 2011). The last four categories (e to h) are considered to be highly hazardous and therefore require special attention.

The Environmental Protection Agency (EPA) lists the following categories of medical waste, refer to Figure 2.2:

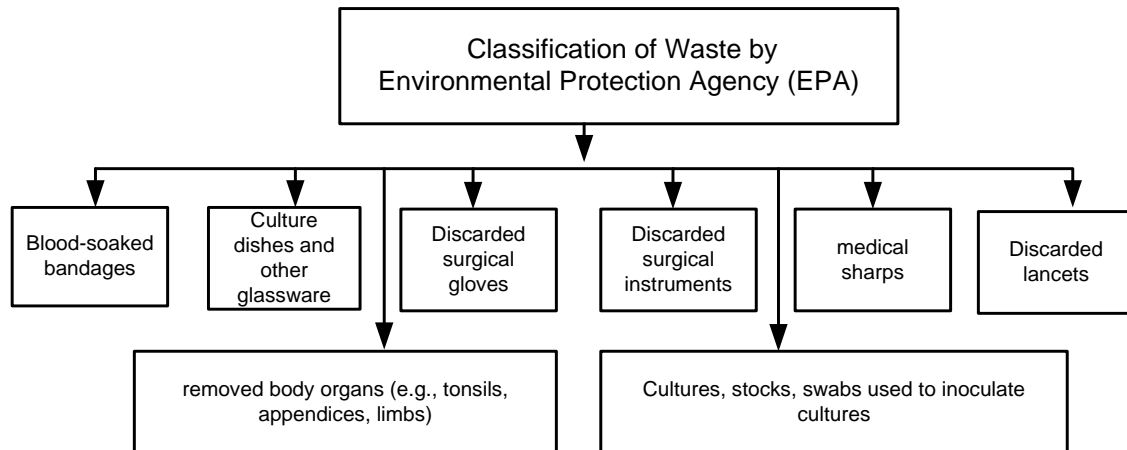

Figure 2.2: Classification of waste by EPA, USA

According to (Budd, Baker 2013, Cheng et al. 2009, Lu, Chang & Liao 2012) the approximate percentage of waste type per total waste in health care centres: non-infectious waste, 80%, pathological sharps waste 1%, chemical or pharmaceutical waste 3%, pressurized cylinders, broken thermometers less than 1%, and infectious waste 15% "Health-Care Without Harm"

## 2.4 Categories of Medical Waste

In accordance with World Health Organisation (WHO)'s established criteria (Chaerul, Tanaka & Shekdar 2008), clinical/healthcare waste can be grouped under five categories for the purposes of risk assessment (see Table 2.1).

Group	Explanation
A	<ul style="list-style-type: none"> <li>• All human tissues</li> <li>• Blood and blood products</li> <li>• Surgical dressings, swabs and other waste from the treatment of patients that are significantly soiled with blood, pus or serous fluids.</li> </ul>
B	<ul style="list-style-type: none"> <li>• Discarded used syringe needles</li> <li>• Cartridges</li> <li>• Broken glass and other contaminated disposable sharp instruments or items</li> </ul>
C	<ul style="list-style-type: none"> <li>• Microbiological cultures and waste from pathology departments (clinical laboratories and post-mortem rooms)</li> </ul>
D	<ul style="list-style-type: none"> <li>• Expired or unutilized pharmaceuticals (other than intravenous infusion preparations, such as saline, which are non-environmentally polluting)</li> <li>• All cytotoxic wastes even when in diluted form</li> </ul>
E	<ul style="list-style-type: none"> <li>• It contains items which usually present low level of risk, and are also produced in greater numbers in community and home settings</li> <li>• Items used to dispose of urine, feces and other bodily secretions or excretions assessed as not falling within Group A</li> <li>• This includes used disposable bed pans or bed pan liners, incontinence pads, stoma bags and urine containers</li> <li>• As clinical waste only if they originate from patients infected with risky etiologic agents they will be treated in the same way as Group A wastes</li> </ul>

Table 2.1: Categories of hospital waste according to WHO (Chaerul, Tanaka & Shekdar 2008)

Therefore, the medical waste is defined more broadly than infectious waste or regulated medical waste, but less broadly than hospital waste. The portion of medical waste capable of producing an infectious disease is considered to be infectious waste. In order for waste to be infectious, the four conditions necessary for infection to occur a virulent pathogen, sufficiently high dose, portal of entry, and host resistance must be present. CDC considers microbiological waste (e.g., cultures and stocks), blood and blood products, pathological waste, and sharps to be infectious waste.

Most waste generated in healthcare establishments can be treated as regular, solid municipal waste but a varying proportion of HCW requires special attention including sharps (e.g. needles, razors, and scalpels), pathological waste, other potentially infectious waste, pharmaceutical waste, biological waste, and hazardous chemical waste (Bartley, Olmsted & Haas 2010, Babanyara 2013, Blenkharn 2009). Collectively, these wastes are known as SHW (Special Healthcare Waste). In addition, all waste generated under certain circumstances, such as in isolation wards and microbiological laboratories, requires special attention. Other waste streams generated by HCW could include packaging, reusable medical equipment, and secondary waste created through disposal technologies.

The mismanagement of healthcare waste poses risks to people and the environment. Healthcare workers, patients, waste handlers, waste pickers, and the general public are exposed to health risks from infectious waste (particularly sharps), chemicals, and other special HCW. Inappropriate disposal of special HCW, including open dumping and uncontrolled burning, increases the risk of spreading infections and of exposure to toxic emissions from incomplete combustion (Pandelova et al. 2009). For these reasons, occupational health and safety should be a component of HCW management plans.

Transmission of disease generally occurs through injuries from contaminated sharps. Infections of particular concern are Hepatitis B Virus (HBV), Hepatitis C Virus (HCV), and the human immunodeficiency virus (HIV). For example, HBV can remain infectious for a week if kept at room temperature even if is dried; the probability that a single needle stick will result in spread the virus in 0.3 % of cases. For HCV (Hepatitis C Virus) and HIV, the probability of that single needle stick will result in zero-conversion is 0.3- 0.5 % and 2-5 %, respectively (Tsakona, Anagnostopoulou & Gidarakos 2007).

In the healthcare sector alone, the World Health Organization estimates that unsafe injections cause approximately 30,000 new HIV infections, 8 million HBV infections, and 1.2 million HCV infections worldwide every year (Chaerul, Tanaka & Shekdar 2008). Toxic risks arise, among other things, from reagents particularly laboratory reagents, drugs, and mercury thermometers (Ho, Liao 2011). High degree of care is needed in the management of special HCW when dealing with biological waste. Many cultures have fixed views on the disposal and burial of body parts. It is important to consider cultural factors in the disposal plans of biological waste (Faisal, Khan & Farooqi 2010).

Appropriate consideration of local community perception in the proposed waste management plan for all HCW is vital to a sustainable disposal plan. To ensure improvement and continuity in the management practices, healthcare institutions should develop clear plans and policies for the proper management and disposal of wastes. This kind of classifications is used to determine their need to be integrated into routine employee training, continuing education, and management evaluation processes for systems and personnel. It is important to point out that all hospitals in the study area promote the final disposal of the domestic wastes in open dumpsites, representing serious sanitary, environmental and social problems.

## **2.5 Regulated Medical Waste**

Regulated Medical Waste (RMW) refers specifically to the seven different classes of medical waste required by the EPA (Eker, Bilgili 2011). The various definitions yield significant differences in the amounts of waste identified as infectious, and therefore, affect the costs of managing infectious wastes. For example, 3–6% of a hospital's total waste might qualify as infectious waste using CDC definitions, whereas 7–15% of hospital waste would be considered infectious waste using the broader EPA definitions (Bai, Vanitha & Ariff 2013). Because the cost of infectious waste disposal can be as much as 6–20 times higher than that of solid waste disposal, it is advisable for hospitals to use a narrow definition of infectious waste as possible, taking care to identify the components of the waste stream that are truly capable of transmitting disease. In addition to the discrepancies in definitions about medical and infectious waste, hospitals have also faced ambiguities in regulations, guidelines, and standards that apply to these waste streams, something that has led to confusion among the hospital, industry and waste



managers about the proper management procedures (Bartley, Olmsted & Haas 2010). Infectious waste per patient per day still varies considerably because of this lack of consensus on definitions.

Though there is no universally accepted definition for RMW, the definitions offered by regulatory agencies are similar. The Environmental Protection Agency (EPA), the Centres for Disease Control and Prevention (CDC), the World Health Organization (WHO) and the Occupational Safety and Health Administration (OSHA) agree that “regulated medical waste” includes those wastes with the potential for causing infection and for which special precautions are prudent.

## **2.6 The Need for Medical Waste Management**

Medical waste can be infectious and hazardous, and it is highly likely that patients, healthcare staff in a hospital, waste handlers, and the community be exposed to the infectious medical waste. Highly publicized issues such as medical debris washing up on beaches and increasing numbers of AIDS and Hepatitis B and C cases have focused public attention on medical waste. Improper management of medical waste raises concern over the health risk posed by its infectious character, the potential safety hazards posed by needles and other sharps, and the aesthetic degradation of exposed environments. It can be the cause of various infections, toxic effect, injuries and risks polluting the environment. It is important to point out that the term ‘medical waste’ has often been used interchangeably with other terms such as ‘hospital waste’ and ‘infectious waste’ around the world. To create safe, responsible and customized programs to collect and dispose of medical waste in Saudi Arabia, it is important to prepare and implement the medical waste policies. In addition, public awareness is very important and need to find the sources such as media which can effectively influence the healthcare sector to adopt the proper medical waste management procedures.

## **2.7 Monitoring and Control of Healthcare Waste**

As a form of hazardous waste, medical waste requires monitoring, i.e. making sure that the whereabouts of such wastes are known at all times, that is, from the point of generation to the point of disposal. Control of medical waste can be fully achieved when adequate monitoring

facilities are available. Control means that competent authorities can act rapidly to ensure that the possibilities for inappropriate handling of wastes or dumping are minimised (Zhao et al. 2010). This means also that authorities have the power, both legally and financially, to act quickly in order to reduce dangers posed to human health and the environment.

For adequate monitoring and control, every country needs proper national legislation on hazardous waste. In the legislation, the two terms “waste” and “hazardous” must be clearly defined. A survey conducted in some countries shows that environmental laws covering hazardous waste differ in several aspects (Insa, Zamorano & López 2010, Cheng, Li & Sung 2010, Patwary, O’Hare & Sarker 2011a). In most Western European countries, for example, definitions exist, but differ from country to country, which may lead to all kinds of problems and misunderstandings in, for example, trans-boundary shipments of hazardous wastes. Also, because hazardous waste is an international problem, then international agreements on proper and consistent definitions are recommended.

An improvement is also required in the existing of National Medical Waste regulations. Figure 2.3 shows the National Legal and Regulatory Framework timeline for the regulations which at least mention “medical waste management”.

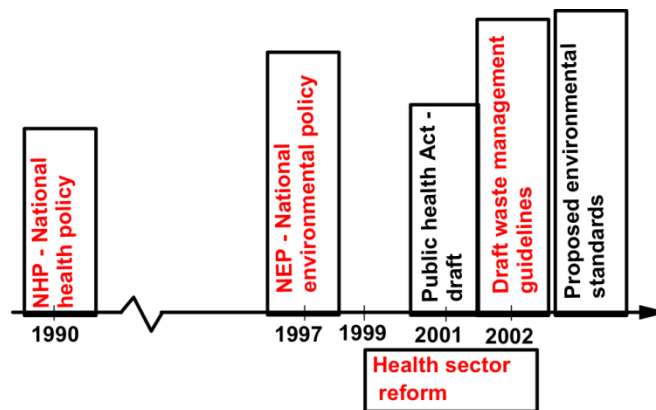

Figure 2.3: A time-line of national legal and regulatory framework for waste management (Sakai et al. 2011)

The draft waste management guidelines, for example, were made in 2002, and to date, they have remained as guidelines only (Sakai et al. 2011). To regulate medical or hazardous waste,

one must first define what hazardous waste is, and such a definition must be something that can be determined or tested. The definition must also be protective of human health and the environment. It is also important to create regulations that have the spirit of the law and yet does not lead to the adoption of expensive and time consuming testing requirements.

Other countries and regions such as North America, Scandinavia, and European Community (Pichtel 2010c) distinguish hazardous waste from other wastes and put more emphasis on the incineration of hazardous wastes. However, this is done at differing levels of compliance with hazardous waste management regulations. Compliance levels can also be compared between different countries using the total sum of the compliance levels offered for a number of criteria used in assessing compliance with waste management regulation. Figure 2.4 compare the scores on compliance and extent of environmental laws for the 10 countries in the European community.

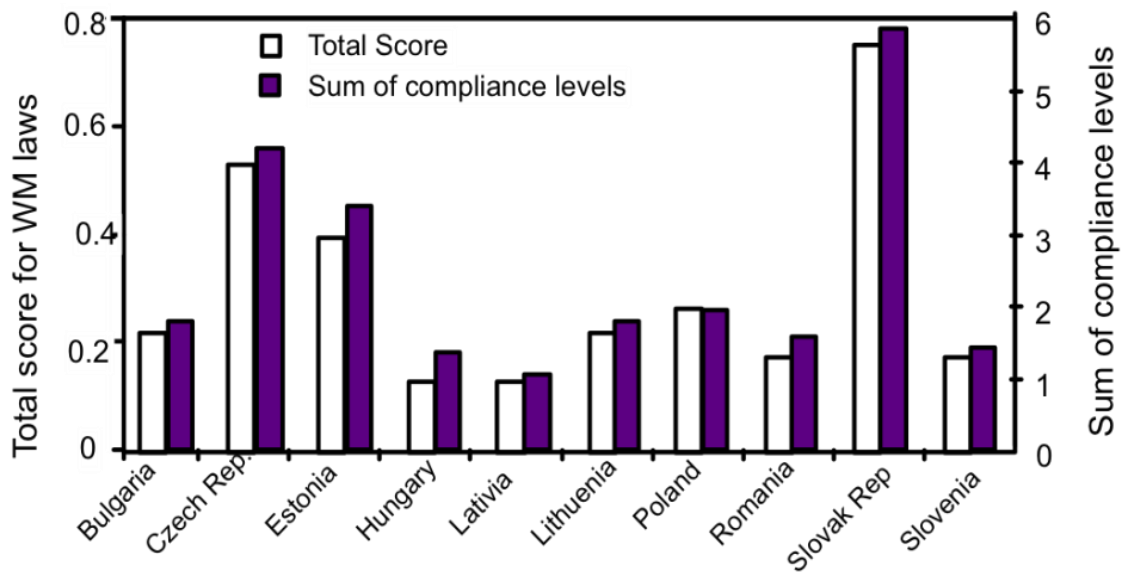

Figure 2.4: Comparison of waste management laws and compliance levels for European Community countries (Pichtel 2010c)

Criteria such as whether the WM is regulated by laws; whether the WM regulations cover waste management plans (WMP) ; and whether the WM regulations have been developed for hazardous waste and other wastes were used to generate data for Figure 2.4 (Pichtel 2010c).

## **2.8 Medical Waste Management policies in Developed Countries**

In developed countries, legislation and good practice guidelines define medical waste and state the various possible ways for the collection, transportation, storage and disposal of such waste (Patwary, O'Hare & Sarker 2011b). The best available technologies are used for the development of alternatives for the proper disposal of medical waste with minimal risks to human health and the environment is investigated in this chapter to illustrate a comparison between what is happening in the developed countries and developing countries as a way to find a gap between the culture and technological method that are used in various countries This is believed to be supportive in designing an accurate framework in such a country as KSA.

High-income countries can generate up to 6 kg of hazardous waste per person in a year. In the USA around 15% is considered as infectious wastes (Wen et al. 2013a), while in France, 15–20% of healthcare waste is infectious waste (Sakai et al. 2011). Today, the collection, transportation and disposal of waste have turned into a complicated and important problem that needs to be regulated by well-defined rules. This issue is so important that in many industrialised countries, specific rules and regulations have been implemented for medical institutions, regardless of whether they belong to the public or to the private sector (New York State, Department of Environmental Conservation, 1996). However, the focus of attention has been mainly at the reduction of clinical waste. Much of the research work into the overall management of healthcare or medical waste has been done in countries such as the United States of America (Conrardy et al. 2010).

The possible presence of pathogens means that healthcare waste can also potentially be dangerous. In addition, pre-sorting and segregating wastes has been shown to significantly reduce uncontrolled emissions as well as the volume and toxicity of ashes (Babanyara 2013). Sustainable waste management is a particularly difficult challenge for the UK where the

traditional approach has been to concentrate on disposal to a cheap landfill and on government supported recycling (Demirbas 2011).

### **2.8.1 USA**

Most studies reported that US hospitals generate between 0.9 to 1.8 Kg of infectious waste per patient per day, or about 15% of the total hospital waste stream (Ahmed, Soni & Gupta 2013, Berwick, Hackbarth 2012). In the 1980, hospitals in USA faced new regulation regarding the handling and disposal of infectious waste. As a result, specialised commercial infectious waste disposal services became available, increasing the cost of infectious waste management. The adoption of an effective infectious waste policy can reduce exposure to infectious waste, decrease labour, lower costs, and yield better compliance with regulatory and accrediting agencies. Thus hospitals can both save money and provide a safe work environment. In the United States, the Occupational Safety and Health Administration sets the standards for worker safety in healthcare facilities and the handling of infectious waste (Bai, Vanitha & Ariff 2013, Berwick, Hackbarth 2012).

Medical waste is not uniformly regulated at the state level throughout the United States; in some states, regulations have not yet been adopted. At the same time, federal regulations (such as air pollution and solid/hazardous waste laws) have also limited alternatives to on-site treatment methods of medical waste. Regulations have also forced hospitals to change either medical waste or infectious waste management practices. For example, in many states infectious waste must be treated before being buried in a landfill, or it is required to be segregated and labelled before being hauled to a commercial facility. Nevertheless, an estimated 60% of the nation's medical waste is still disposed of in small to medium-sized incinerators located on-site at hospitals and other medical facilities. In addition to these facilities are commercial incinerators that accept medical wastes from a variety of sources. Commercial units, which are much larger than on-site hospital incinerators, burn an estimated 20% of the nation's medical waste. The remaining 20% is autoclaved and either directly placed in a landfill, or fired in a municipal waste incinerator and then placed in a landfill.

According to (Komilis, Fouki & Papadopoulos 2012c) OSHA (Occupational Safety and Health Administration), regulated waste is defined as: Liquid or semi-liquid blood or other potentially

infectious materials; contaminated items that, if compressed, would release blood or other potentially infectious materials in a liquid or semi-liquid state; items that are caked with dried blood or other potentially infectious materials and are capable of releasing these materials during handling; contaminated sharps; and pathological and microbiological wastes containing blood or other potentially infectious materials.

Various state regulatory agencies including USCentres for Disease Control and Prevention published OSHA standards and other guidelines for the control of infectious waste during the past five years, various aspects of medical and infectious waste management have been researched in USA.

Currently, the operating incinerators operate in the absence of state regulations specific to these types of facilities. Based on one of the studies (Zhao et al. 2010, Bartley, Olmsted & Haas 2010, Brewer, Antell 2012, Cheng et al. 2009), the following recommendations were made:

- Federal or state agencies should draft universal definitions of infectious waste with input from waste management companies, hospitals, and accreditation organizations
- The adoption of a universal definition will likely make the process of separating infectious waste from other less regulated medical waste less confusing, and contribute to a decrease in the volume of waste as well as in the cost of waste management
- Waste management hierarchy programs (reduce, re-use, recycle) should be instituted in all hospitals as an overall policy to reduce both the quantity and toxicity of waste generated

## **2.8.2 United Kingdom & European Union**

The quantities of waste generated by the healthcare sector in the United Kingdom (UK) have been shown to be amongst the highest in Europe (Costa, Massard & Agarwal 2010). There has been growing interest among medical organisations in strategies to reduce the quantity of healthcare waste. The development of an effective 10-year strategy for the management of healthcare waste in large organisations such as the NHS (National Health Services) has to involve a steep change in policies and practices throughout the organisation.

NHS can contribute to the fulfilment of national targets for waste that the government has set for local authorities. Under 'Sustainable Development. Environmental Strategy for the NHS' (NHS Estates), the NHS is advised to produce local strategies for waste management (as well as energy, transport, water and procurement). Trusts are also obliged to comply with the Standards for Better Health, which cover waste management as a core standard. The NHS in England generates around 104,700 tons of clinical waste (Tudor et al. 2010) and, as a waste producer, has a legal responsibility to properly manage waste and reduce environmental impacts as a result of waste production and disposal. The Environmental Protection Act 1990 and Environmental Protection (Duty of Care) regulations 1991 imposes legal "duty of care" requirements on waste producers, such as the NHS, to ensure the appropriate safe handling and disposal/treatment of waste. It is now possible for GPs to prescribe sharps bins and legislation surrounding the disposal for sharps bins is available.

Waste legislation in the UK is driving all waste producers to operate in a more sustainable manner and the NHS and private hospitals cannot afford to ignore this change forever. The cost of disposal, which can exceed £450/ton in the UK (Tudor 2011), reflects the complexity of control imposed on the transfer, storage and destruction of waste, and the disposal of the resultant treatment residues.

Several decades of advances in the standards of clinical waste disposal in hospitals have enabled substantial risk reduction, although this has not been subject to formal audit. When developing its policies on waste, the assembly is obliged to do so within the context of overarching European Union policy (Pires, Martinho & Chang 2011a). The treaty of establishing the European Community (as amended by the Treaty of Amsterdam 1997) sets out a series of objectives and principles for community policy on the environment which the assembly must follow.

The EU also has a community strategy for waste management (1989 and updated by a resolution in 1997), which includes the following strategic guidelines:

- Minimising waste production and the hazardous properties of waste should be the first priority;

- Promotion of waste reuse, recycling, composting and energy recovery to reduce the quantity of waste for disposal and save natural resources;
- A preference for reuse and materials recovery over energy recovery (subject to the outcomes of further research);
- Promotion of collection and recovery systems and action to promote markets for recycled products; was revised in 2002 as part of the 'Rio+10' conference.
- Minimisation and optimisation of waste disposal.

The European Commission has issued proposals for the Sixth Environment Action Program for the European Community (Bryant 2010), which considered by the European Parliament and the European Council. European Council Directive 91/689/EEC (the Hazardous Waste Directive or HWD) sets the framework within Member States of the European Community for provisions to control the movement of hazardous wastes. The aim of the HWD is to provide a precise and uniform European-wide definition of hazardous waste and to ensure the correct management and regulation of such waste. The HWD definition of hazardous encompasses all kinds of waste included on a list drawn up by the European Commission (De Sadeleer 2013), because they possess one or more of the hazardous properties set out in the HWD. In 1994, a comprehensive list of all wastes, hazardous or otherwise, was produced pursuant to the Waste Framework Directive. This list was known as the European Waste Catalogue (EWC 1994). The EC then identified which of the wastes on EWC 1994 were deemed to be hazardous based on the properties set out in the HWD. The resulting list of wastes was called the Hazardous Waste List (HWL) and was the list defining hazardous waste required by the HWD (Llatas 2011). The EWC 1994 and HWL have been updated, combined and significantly extended. This resulted in a revised European Waste Catalogue which was implemented by Member States on 1<sup>st</sup> January 2002 (Wen et al. 2013a). Therefore, this new list defines hazardous waste as required by the HWD.

The definition of hazardous waste has considerable impact upon industry in determining how their waste is regulated and affects them in terms of charging, monitoring and inspection. Over the past decades, the quantities of wastes produced have been increasing worldwide. The situation in CEECs (Central and Eastern European Countries) closely resembles the situation in



the OECD (Organization for Economic Cooperation and Development) countries in the 1980s, when land filling was the main disposal technique. Only minor parts of waste streams were recycled or used as an energy resource. At that time, 60% of the household waste was dumped, 33% incinerated and 7% composted. Since then the share of incinerated and recycled waste has increased substantially. A more recent analysis of waste management in the EU member states showed that the following problems appeared in the 1990s (Wen et al. 2013a):

- Waste generation within the EU and European Free Trading Association (EFTA) has increased by nearly 10% between 1990 and 1995
- Limited availability and quality of data hinder projections of future trends.
- Increasing amounts of waste create new problems, such as rising levels of sewage sludge and residues from the cleaning of flue gases
- Waste transport represents up to 15% of freight in some EU member countries.
- Recycling and reuse schemes are only partially successful.

Waste needs to be prevented and minimised for two major reasons. First, waste is a potential source of pollution and health risks. Second, waste consists of a high volume of recyclable and reusable materials. The main objective of strategic waste planning was to minimise the risks and maximise the waste utilization. In its 1996 communication on the review of the community strategy for waste management (Pires, Martinho & Chang 2011a), the commission stressed that prevention of waste and the minimisation of hazardous substances in waste must stand as the overall targets of a strategy for community waste management. According to the 5<sup>th</sup>EAP (Environmental Action Program) for the year 2000 (Therivel 2012), the management of waste generated within the community was a key task of the 1990s. The community strategy strives for waste minimisation in terms of volumes and environmental hazards/ damages. The program set the EC waste minimisation target for the year 2000 quantities of waste generated at an EC average of 300 kg per capita on a country-by-country basis should be stabilised. Since then the EU waste policies have been further developed. Strategic planning in the EU candidate countries related to waste management must take into account current discussions on further development of the EU waste policies. The 6th EAP (Dale, Robinson 2011) is the most

important document in this respect, laying down priorities and objectives for the decade (2001-2010). The emphasis was put on the strategic planning via preparation of “thematic strategies” with the aim of ensuring sustainable management of resources and waste. In addition, the Thematic Strategy on Waste Recycling was also mentioned in this context. The strategy would identify which waste would get priority in recycling according to an appropriate set of criteria. Five strategic directions are proposed by the Directorate General (DG) Environment; while stress is put on the EU hierarchy of waste management (prevention is followed by reuse, material recycling, energy extraction and final disposal). The directions are:

- To improve implementation of existing community environmental legislation;
- To integrate the environmental dimension into other policy areas;
- To facilitate an active role of the general public in the environmental decision-making process;
- To enhance the use of market instruments through involving businesses and consumers; and
- To plan and manage land-use in a better way.

As the 6<sup>th</sup> EAP indicates, the EC focuses not only on how to modify existing legislation but also on how to implement and enforce it, e.g. by means of civil liability for environmental damage and environmental taxation. DG Environment prepares papers on taxation of virgin raw materials and new eco-taxes on resource- and waste-intensive products and processes.

Hazardous waste, even in small quantities, has a very negative impact on the environment. The total amount of hazardous waste was as much as 36 million tons in EU member countries in 1995. EU countries have shown an apparent increase of approximately 65% in hazardous waste quantities between 1990 and 1995 (De Sadeleer 2013), this is mainly due to amended definitions and new legislation, though. The UK and Germany, for example, show a decrease of 21% during the 1990-1994 period, which was before the introduction of the hazardous waste list (Wen et al. 2013b). This can be explained by the penetration of cleaner technologies, by reuse and recycling, by the closing down of heavy industry, and by the moving of parts of industrial production outside the EU. In CEECs, high quantities of hazardous waste were generated in 1995. However;

the quantities of hazardous waste generated in most CEECs fell in 1999 (except in Hungary). Results for Estonia were not included in the CEEC average, since extremely high amounts of hazardous waste were generated in this country. In 1995 for instance, 4,870 kilograms per capita were generated, falling to 4,008 kilograms per capita in 1999 (Pires, Martinho & Chang 2011a). This high amount was primarily due to the waste from oil-shale mining and power production. Due to the large amount of minerals in oil shale, such waste generation is unavoidable, and unfortunately, present technology offers no way to use the large amounts of oil shale waste. In the case of Slovenia, almost all hazardous waste (97 %) is exported, mainly to Austria, France and Italy. Moreover, data for Slovenia was available only for 1995. As stressed by the EEA, the differences in hazardous waste production between the EU countries depend, among other factors, upon how the wastes are classified. The variations between Austria, Denmark, Ireland, Germany and Spain are explained by the fact that the portion of hazardous waste (as per the Hazardous Waste List), varies from 27 to 71% (Mühlich, Scherrer & Daschner 2003). One can also observe substantial differences in national hazardous-waste classification and categorisation in the new EU members. In the Czech Republic, for example, the total production of hazardous waste according to national classification is 3.1 million tons for 1999, while the total according to the European Waste Catalogue is only 1.32 million tons (Selin, VanDeveer 2006). Keeping in mind the uncertainties in classification of hazardous waste, it is also impossible to judge whether the substantial decreases in hazardous waste generation are caused by technological changes and/or reclassification. One can conclude, therefore, that the amount of hazardous waste per capita may decrease with increasing technological innovations and more effective enforcement of increasingly-stringent technical standards.

### **2.8.3 Czech Republic**

The waste management strategy of the Czech Republic is dealt with in two basic documents: State Environmental Policy and Implementation Plan and national waste management plan revised periodically and accompanied by regional waste management implementation (West, Borzuchowska & Ferreira 2011). The first national management plan had to be prepared by the end of 2002. The act lays down the content of this plan, an obligatory part of which will be submitted to the government and subsequently published in the Collection of Acts.

#### **2.8.4 Bulgaria**

Bulgaria's waste management strategy is outlined in four following documents:

- The National Development Plan 2000-2006 (sector program "Environment"),
- The "Environment-health" National Action Plan,
- The Instrument for Structural Policy for pre-Accession (ISPA)
- Strategy Paper for the Environment, and the National Waste Management Program.

These documents were issued in either 1998 or 1999 and are available to the public. The checklist indicated that almost all areas were at least partially covered; there was a chapter on instruments as well as an enforcement and implementation plan (Scheinberg, Mol 2010). Also included were specific legislative instruments for municipal waste, hazardous and non-hazardous waste.

#### **2.8.5 Poland**

The Polish national waste management strategy and implementation plans are elaborated in two documents: Strategy for Balanced Development in Poland from now to 2025 and the Second Ecological Policy of the State. In that waste management is covered in the Second Ecological Policy of the State in the chapter on waste management (Saner et al. 2011). The following issues are set as a priority:

- To complete adjustments of Polish legislation to EU standards and to prepare a waste Management strategy regarding national, regional and local limits for land filling as a short-term priority;
- To minimise waste production and increase reuse of waste;
- To implement waste management plans and create a collection system as the medium-term priority; and
- To reduce the amount of biodegradable-waste landfills, to achieve the successful removal of old landfills as a long-term priority

- There are no sub-national waste management plans available. Specific legislative instruments provide for municipal waste, hazardous and non-hazardous waste and wastewater treatment sludge.

### **2.8.6 Croatia**

Waste and its management has lately become a pressing topic in Croatia. The European commission stated that waste management is the largest single problem in the environmental protection sector (Botelho 2012). The lack of sanitary landfills and incinerators not only represents environmental and health problems but also political concerns. Medical waste management in Croatia is regulated by three laws and legal documents: Law on Waste 4, Regulations on Waste Type and Directive on the management of waste produced during healthcare (Mühlich, Scherrer & Daschner 2003, Pires, Martinho & Chang 2011b). Furthermore, there is a “Strategy for waste management’ describing the principles of integrated waste management from the point of generation to final disposition based on the principles of sustainable development. A condition to make the system work, and the law to be implemented, is to make education an important component. Education of all subjects in waste management should be increased, in particular, education of persons responsible for the organisation of waste management and those who handle it. The general population should constantly be instructed about waste sorting, recycling, composting and ways of disposing the waste. The final goal is a system that is in harmony with sustainable development, and protects the environment and human health

### **2.8.7 Japan**

In Japan, the first regulation focusing on all medical facilities, such as, hospitals, clinics, laboratories and animal clinics, was promulgated in 1992. Furthermore, many articles (Silva et al. 2013, Wen et al. 2013a) reported technologies of disinfection methods in medical institutions and reports about a management system of infectious waste are rare. In the amended Waste Disposal Law of 1991, infectious-wastes are defined as the pathogen-containing waste materials generated in medical institutions as a result of medical care or research which have the potential of transmitting infectious diseases. Infectious waste materials disposed from medical institutions have been regulated since 1992. Infectious-waste materials become non-infectious after they

have lost infectivity by an intermediate treatment, such as incineration, melting or sterilisation, and have been buried in a landfill.

Not all medical institutions in Japan have obtained accurate information on each infectious waste-handling business including their qualities (such as the number of years dealing in infectious waste and the existence of violations) and a treatment price (Pariatamby, Fauziah 2014). To prevent the illegal dumping of infectious waste materials, an information network needs to be established by the cooperative harmony of stakeholders including the Ministry of Environment. The manager of a medical institution is obligated to educate the persons concerned, such as medical, healthcare and hospital waste workers, about the treatment. Infectious waste must be managed in accordance with the WDL (Waste Disposal Law) of 2003 and the rules promulgated in 2004 by the ministry of environment (Chen 2013). Infectious-waste materials are to be collected and segregated from other wastes, and transported to incinerators where they are combusted by a special waste-handling business with which a medical institution contracts (Babanyara 2013).

The resulting materials are disposed of in landfills or used as fuel. Microwaving usually reduces the volume (by a ratio of 8:1), but not the weight of waste material. It has also been touted to present no air emission problems. No hospitals reported using irradiation, which is consistent with other reports that suggest that irradiation is seldom used to treat medical waste and equipment in hospitals because it is more expensive than other techniques and poses serious disadvantages (Agunwamba, Emenike & Tenebe 2013). Disposal costs are, however, becoming expensive. Therefore, medical institutions should make every effort to reduce infectious waste generated in their facilities. Due to the increase in the quantity and to the diversified quality of waste materials disposed of from medical institutions, the management of such materials has become increasingly important in order to protect waste workers from infection. The revised regulation is expected to encourage the reduction of infectious waste and to protect waste workers from being infected.

### **2.8.8 South Korea**

In South Korea, generation of medical waste from the healthcare industry has rapidly increased over the past decade (Chung 2013). This type of waste results from the treatment, diagnosis, or immunisation of humans and/or animals at healthcare facilities, veterinary and health-related

research centres, and medical laboratories. Although medical waste represents a small portion of the total solid waste stream in South Korea, such waste must be handled with care because of the potentially infectious and hazardous materials contained in it. Improper disposal of medical waste may pose a significant risk to human health and the environment. Some of the problems arising from poor management of medical waste may include damage to humans by sharp instruments, diseases transmitted to humans by toxic and hazardous chemicals (Gautam, Thapar & Sharma 2010). Thus, the management of medical waste is a subject of major concern for any regulatory agency. In South Korea, medical wastes had been regulated by the medical law under the ministry of health and welfare until 1999 (Min, Rhee 2014). These wastes were often mixed with municipal solid waste and commonly disposed of in municipal landfill sites or improper treatment facilities. In addition, information on handling and disposal of medical waste from healthcare institutions was very limited and unknown. Facing the management problems of medical wastes, the national assembly modified the waste management act in 1999 to better control medical waste from the point of generation to its final destination. The Korea Ministry of Environment (MOE) was responsible for implementing the act (Richards, Haynes 2014). In that act, medical waste is classified as designated (or hazardous) wastes and subject to hazardous-waste regulations under the Waste Management Act. The Korea MOE promulgated several regulations for the definition, segregation, packaging, tracking, and disposal of medical waste. Under the Act, medical waste is defined as any solid waste that is generated by medical treatment facilities and laboratories. The quantity of medical waste depends upon several factors such as the size of healthcare facility, the segregation program of medical wastes, and the medical activities. According to the Korean MOE, approximately 33,980 tons of regulated medical waste was generated from 44,478 healthcare facilities in 2002 (Richards, Haynes 2014, Min, Rhee 2014). It is important to note that medical waste has been classified into two major categories since 1999: tissues and others.

The tissues are stored in a refrigerator, and all other wastes are placed and mixed in a large container at room temperature before waste treatment. The generation of medical waste in Korea has been increasing in quantity and variety, due to the wide acceptance of single-use disposable items such as gloves, plastic syringes, medical packages, bedding, tubing, IV bag and containers. Incineration will be dominant as a medical waste treatment in Korea because another common treatment method, steam sterilisation, will no longer be available in the near future (Kang et al.

2013). Therefore, toxic substances such as dioxin emissions at medical waste incinerators should be closely monitored to reduce potential risks to humans and the surrounding environment. Other potential treatment technologies, such as pyrolysis and microwave disinfection, should be examined as alternatives to incineration in order to better manage medical waste in Korea. One of the studies showed that waste-generation rates would differ between public hospitals and private clinics (Faisal, Khan & Farooqi 2010). That study also revealed that none of the health institutions surveyed treated its wastes before disposing of them into municipal dumpsites. Microwave irradiation and waste segregation were not practiced. However, the waste segregation could be a treatment option in the management of hazardous medical wastes.

## **2.9 Waste management in Developing Countries**

In developing countries medical waste materials have not received sufficient attention yet. Healthcare waste typically derives from two sources in developing countries: emergency relief donations (leftover from international donor response to either a humanitarian crisis or a natural disaster) and long term healthcare services (Patwary, O'Hare & Sarker 2011b). Healthcare services aim to reduce health problems and to prevent potential health risks. In doing so, waste is often generated that is potentially harmful to public health and the environment. In several countries, where many health concerns often compete for very limited resources, the management of healthcare waste may not get the priority it deserves.

In less developed and transitional countries, waste disposal options are limited, and small-scale incinerators have been used as an interim solution. Incinerators emit a variety of harmful pollutants, including particulate matter, mercury, dioxin and furans (Chen 2013, Demirbas 2011, Gautam, Thapar & Sharma 2010).

Thus, in addition to risks to health from infectious agents, long-term low-level exposure of humans to dioxins and furans may lead to impairment of the immune system, and impaired development of the nervous system, the endocrine system and the reproductive functions. In developing countries, solid wastes have not received sufficient attention, hazardous and medical wastes are still handled and disposed together with domestic wastes, thus creating a great health risk to municipal workers, the public and the environment (Patwary, O'Hare & Sarker 2011b, Ahmed, Soni & Gupta 2013). The most common method of land disposal of solid wastes used is



the open dump. This method of waste disposal poses severe negative public and environmental health effects, in particular with healthcare wastes, and must be discontinued.

In the majority of low-income countries, healthcare waste is usually not separated into hazardous or non-hazardous waste. In these countries, the total healthcare waste per person per year is anywhere from 0.5 to 3 kg (Hossain et al. 2011c). In general, there is a lack of organisation and planning in waste management due to insufficient information about regulations and due to financial restrictions in many developing countries. Resources are inadequate to manage these wastes, only few staff of the healthcare facilities are acquainted with the methods required for proper waste management in most of underdeveloped countries (Patwary, O'Hare & Sarker 2011b). Oftentimes, the management of wastes is delegated to poorly educated and untrained labourers, who perform most activities without proper guidance and insufficient protection. An effective and efficient program for the management of healthcare wastes is a critical component of a facility's infection control program and, consequently, plays an important role in the quality of care as well as in the occupational health of the entire staff of the facility. Although proper management of healthcare wastes includes a number of activities and several members of the staff. Surveys show that the total amount of HCW generated in a hospital in an industrialised country is approximately two to more than seven times that generated in developing countries. The relatively large amounts of wastes generated in hospitals in developed countries come mostly from the very heavy reliance on disposable instruments and materials, and on increased packaging of the products used. Based on an analysis of HCW management in developing countries (Hossain et al. 2011c, Bai, Vanitha & Ariff 2013), it is apparent that: most developing countries are becoming more and more aware that healthcare wastes require special treatment. Every year, relatively large quantities of potentially infectious and hazardous wastes are generated in healthcare facilities throughout the world. Unfortunately, most underdeveloped countries are constrained by a number of factors from adequately managing these wastes. At the present time, a significant fraction of healthcare wastes collected in developing countries is either disposed of on land or incinerated. There is a slow but concerted effort to discontinue the reliance on incineration for the treatment of HCW and it is expected that the incineration of HCW in developing countries will be phased out within the next ten years (Anastasiadou et al. 2012).

In order to protect the public and the environment, most industrialised societies have established laws that regulate various emissions of harmful substances. Although, many countries adopt the recommendations of the World Health Organization (WHO) as their standards, very often the standards of USA Environmental Protection Agency (EPA) are used as well.

### **2.9.1 Saudi Arabia**

The population of Saudi Arabia is 100% Muslim, except for the minorities of Western and other expatriates. Under Islamic law, stillbirth, human organs and body parts, and human placentas are buried. However, human tissues and specimens generated from autopsy or during operation are incinerated. The infectious waste problem in Saudi Arabia is usually caused by the lack of a universally accepted definition of “infectious waste,” rather than by financial and technical difficulties. This usually leads to the over-disposing of waste that requires incineration, even though many hospitals in Saudi Arabia, have given full consideration to replacing single-use, waste-generating disposable items with those that are reusable and can be reprocessed (Almalki, Fitzgerald & Clark 2011). A written policy was introduced on waste management in December 1999, and it was fully implemented in January 2000. The policy included the definitions of “infectious waste” and the disposal method for each waste category. Infectious waste was defined as “specific kinds of waste generated by patient diagnostic and therapeutic procedures that are capable of producing an infectious disease and must be disposed of in such a manner as to minimise the risk of infection to healthcare workers, sanitation workers, and the general public (Almuneef, Memish 2003). The Ministry of Health in Saudi Arabia recently developed regulations for the management of medical waste, which include a definition for infectious waste.

One of the studies (Hagen, Al-Humaidi & Blake 2001)describes the efforts made by a large healthcare provider in Saudi Arabia, ‘Saudi Aramco Medical Services Organization (SAMSO)’ to successfully use infectious waste surveys to reduce its infectious waste stream; reduce the load on its incinerators; identify and eliminate specific items of concern from infectious waste bags; and provide a safer work environment for housekeeping staff. This is the first report in the country that gives such an extensive analysis of a hospital’s infectious waste. All housekeeping personnel are immunised against hepatitis B at the beginning of each contract. A SAMSO Medical Housekeeping Supervisor, together with a staff of inspectors and trainers, conducts

intensive, task-oriented training at the beginning of new contracts on a weekly basis during the term of the contract (Almalki, Fitzgerald & Clark 2011). This is to ensure that SAMSO meets the Saudi Arabian Government and Joint Commission International (JCI) standards for infection control and environmental care (Mufti 2000, Taher, Hajjar 2014). SAMSO has a well-defined medical-waste management system incorporating colour-coded labels for waste containers and colour-coded plastic bags. Before collection, each bag of infectious waste is routinely labelled with the name of the unit generating the waste and the date of collection. This is to ensure that the source of any sharp or other inappropriately discarded item can be traced. Bags are then transported to on-site incinerators. Incinerator ash, together with regular waste, is transported to Saudi ARAMCO's own sanitary landfills. In 1991 SAMSO had a project to upgrade its largest incinerator at Dhahran Health Centre (DHC) (Al-Falih 2010). In an effort to better characterise its infectious waste stream, "tune" the incinerator to the type of waste being burned, and reduce overall loading on all of its incinerators, an effort was made to examine DHC's infectious-waste stream in detail to determine how much material was actually infectious. This was accomplished through an infectious-waste survey that was conducted during September and October 1991. However; colour-coded bags (orange for medical waste and black for general waste) were available and distributed randomly in all hospital areas. Baseline disposal practices at the generation point were checked and the route of the waste from its source (at point of use) to final disposal followed. In addition, staff, including physicians, nurses, housekeepers, and allied health personnel involved in waste disposal were interviewed to assess their knowledge about waste identification and the perceived disposal method (Taher, Hajjar 2014). They audited the type and amount of waste generated from all hospital areas to see if all waste designated as infectious waste truly was infectious waste as classified in accordance with CDC guidelines. Baseline data were taken on the number of skips (steel containers filled with infectious waste) being incinerated per month for 4 months before the intervention.

A waste management plan was developed that included input from all user groups. The nursing managers and employees in different departments were interviewed. Their views on the problems as well as how these problems impacted the quantity and placement of orange bags were taken into consideration when developing the plan. The aim was to reduce the amount of waste being incinerated by source reduction. Colour-coded waste disposal bags were distributed for ease of identification and separation of waste. The investigating team completed a hospital-

wide mandatory in-service training for all staff on waste management. They introduced a written policy on waste management in December 1999, and it was fully implemented in January 2000. The policy included the definitions of “infectious waste” and the disposal method for each waste category. Infectious waste was defined as “specific kinds of waste generated by patient diagnostic and therapeutic procedures that are capable of producing an infectious disease and must be disposed of in such a manner as to minimise the risk of infection to healthcare workers, sanitation workers, and the general public. One other report from the eastern region shows a 65% reduction in infectious waste generation through education and a waste-segregation program. However, there is nothing in that report to indicate that any cost analysis was done before or during the implementation of the program. Over-disposing of medical waste seems to be a problem in many hospitals in Saudi Arabia. A survey of 27 hospitals in different regions revealed that the healthcare-risk waste rate of generation was  $1.13 \pm 0.96$  kg/bed/day. This is a higher rate compared with the international figures listed by the World Health Organization for low- and middle-income areas. The waste-management plan that they initiated with the introduction of a written policy on waste management was crucial in accomplishing waste reduction and cost savings. A clear and precise definition of “infectious waste” on the basis of CDC and EPA guidelines was included in the policy. In addition, infectious-waste categories were identified in an appendix that explained the disposal method of specific items. Finally, the study concluded that many hospitals in Saudi Arabia have a problem with over-disposing infectious waste, and initiation of a well-formulated waste-management plan can be cost effective, as well as it can protect the environment, and is feasible. This indeed supports the necessity of the current research.

As it has been seen from the previous discussion, there is no proper management for the waste generation and treatment in most of the developing countries, where some necessary technologies are not used and processed such as autoclaving and incineration, and basic technologies such as steam disinfection is used to treat serious and dangerous hazardous wastes, as in most of the cases some treatment operations such as incineration is used in poor percentage or in improper operations (BAN & HCWH, 1999).

## **2.10 Legal provisions**

National legislation is the basis for improving healthcare waste practices in any country. It establishes legal controls and permits the national agency responsible for the disposal of healthcare waste, usually the ministry of health, to enforce their implementation. The ministry responsible for the environment or the national environmental protection agency may also be involved; there should be a clear designation of responsibilities before the law is enacted. The law should be complemented by a policy document and by technical guidelines developed for its implementation. This legal “package” should specify regulations on the treatment of different waste categories such as segregation, collection, storage, handling, disposal, and transportation of waste, as well as responsibilities and training requirements; it should take into account the resources and facilities available in the country concerned and any cultural aspects of waste handling. A national law on healthcare waste management may stand alone or may be part of more comprehensive legislation such as the following:

- Law on management of hazardous wastes: application to healthcare waste should be explicitly stated; law on hospital hygiene and infection control: a specific chapter or article should be devoted to healthcare waste. The law should include the following:
- A clear definition of hazardous healthcare waste and of its various categories;
- A precise indication of the legal obligations of the healthcare waste producer regarding safe handling and disposal;
- Specifications for record-keeping and reporting; specifications for an inspection system
- To ensure enforcement of the law, and for penalties to be imposed for contravention;
- Designation of courts responsible for handling disputes arising from enforcement of or noncompliance with the law

In addition, hospitals should be run, and healthcare waste disposed of, in accordance with all other relevant national legislation, such as regulations pertaining to waste in general; effects on public health and the environment; air quality; prevention and control of infectious disease; management of radioactive materials.

## **2.11 National Regulations**

Healthcare facilities and centralized treatment/disposal facilities may need to comply with relevant national legislation. This would include waste regulations; regulations on environmental and health-impact assessments; environmental emissions standards; prevention and control of infectious disease regulations; regulations on the management of radioactive materials; and special emergency procedures. Few developing countries have appropriate laws and/or regulations concerning HCW management. In countries where such laws exist, they generally focus on treatment aspects of healthcare waste, usually by providing for on-site incineration. But on-site incineration may be neither cost effective nor environmentally sound. Regulations developed in conjunction with a national healthcare strategy may be implemented faster than new legislation and yet may have essentially the same effect as laws. Regulations should include clear definitions; precise indications of legal obligations for healthcare facilities, municipal waste managers, and disposal facilities; applicable enforcement and penalty systems; and delegation of legal courts to handle disputes. In some cases, different schedules for compliance with such regulations are recommended: teaching hospitals first, for example, then larger hospitals, and then smaller facilities. This would help in cases where healthcare facilities have widely different levels of resources available to them, and some may need more time to conform to new regulations.

## **2.12 Summary of the Chapter**

In this chapter a critical literature review of medical waste management is presented. In addition, the categories of waste and its management policies in both developed and developing countries have been discussed. It is concluded that, the management of medical waste has been of major concern due to potentially high risks to human health and the environment. Waste minimization and recycling are still not well promoted, which results in significant amounts of medical waste to be disposed of. The much more efforts have to be made for the minimization and recycling of medical waste prior to final disposal whether not infected or contaminated. The next chapter is an overview of the technologies have been developed and used for the medical or healthcare waste management.

# Chapter 3: Medical Waste Management Practices and Technologies

---

There are various medical waste management technologies that have been proposed in literature and implemented in various countries. Each technology has its own advantages and limitations. Implemented management technologies may influence safe health practices and policies and have subtle impact on healthcare settings and environment. In this chapter, the commonly used medical waste technologies and practices are surveyed and discussed with their technical details and their related issues, in order to understand how medical waste is processed and contained, and to assess its safe practice within the case study. This study will support the measures required for a proper MWM in Riyadh hospitals.

## **3.1 Waste Management Practices**

The best medical waste management practice is to prevent and minimise the generation of waste (Hossain et al. 2013). The management of waste must be consistent from the point of generation (“cradle”) to the point of final disposal (“grave”). Therefore, those technologies have been investigated to pave the way for conducting a proper strategic framework that is suitable to be applied according to specific waste management situations that are existed in KSA. The surveyed management practices have been conducted to meet the technological challenges that could possibly face the employment of MWMT in the KSA.

Several Waste management practices are presented in this chapter beside its operational stages and problems that could be faced when applying them in different cultures and premises. It is clear from the current status of healthcare waste generation and its management facilities for KSA hospitals that it needs to apply a specific criteria to reach the optimum solution. It will be discussed in the following chapters that serious developed technologies are required to be applied and developed continuously. The technologies and practices have to apply according to the current outcomes and level of provided services from the governmental and private

companies. The type and process of the management practices are important as it is considered the optimum solution that is supposed to be appropriate. The proposed solutions should be outlined according to the findings and results of the current status of the MWMT in Saudi Arabia.

### 3.1.1 Waste Minimisation

This first step comes prior to the production of waste and aims at reducing as much as possible the amount of HCW that will be produced by setting up an efficient purchasing policy and having a good stock management.

### 3.1.2 Segregation and Containerization

Management of medical waste can be obtained by segregation (separation) and identification of the waste. Therefore, it is important to have an efficient segregation system as well as designated storage area within the healthcare establishment. The most appropriate way of identifying the categories of medical waste is by sorting the waste based on colour code within the recommendations and guidelines of the WHO (Dohare, Garg & Sarkar 2013). Figure 3.1 presents some of the recommended colour coding techniques and types of containers to be used for the segregation and storage of the various elements of medical waste.

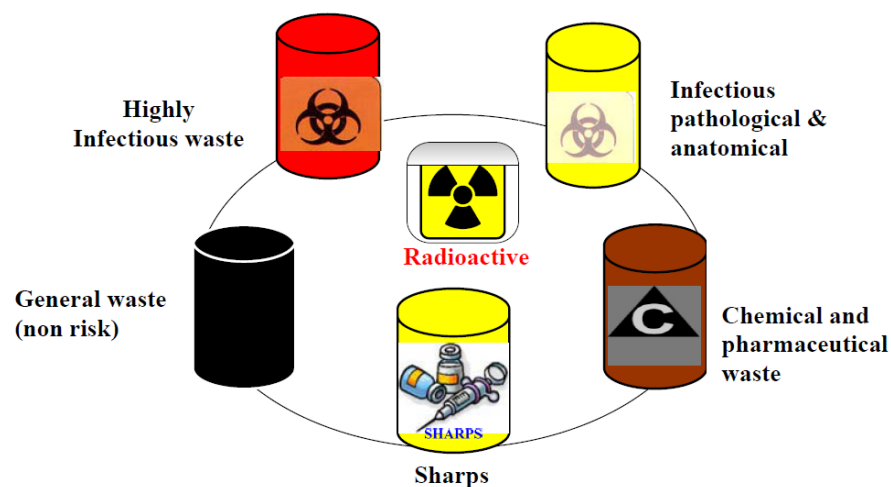



Figure 3.1: Collection containers with different colour coding and labelling  
(Bala, Narwal 2013a)

WHO recommends that medical waste be segregated into the appropriate containers/ bags at the point of generation. To encourage segregation at source, reusable containers or baskets with liners of the correct size and thickness must be placed as close to the point of generation as possible (Bala, Narwal 2013a). They should be properly codified by colour-coded (yellow or red for infectious waste) and have the international infectious waste symbol clearly marked. When they are 3/4 full, the liners must be closed with plastic cable ties or string and placed into larger containers (Mathur 2014).

- Clinical waste bags are tagged with a code to identify the area from which the waste was generated
- Clinical waste bags are sealed correctly when no more than 2/3 full
- Sharps containers are sealed correctly when no more than 2/3 full
- Sharps containers are tagged with a code to identify the area from which the waste was generated

### **3.1.3 Labelling Requirements for Medical Waste Containers**

Medical waste contained in a red biohazard bag must be labelled with the words “Biohazards Waste” or with the international biohazard symbol and the word “BIOHAZARD” (Bala, Narwal 2013b)

1. Tie red biohazard bags to prevent leakage or expulsion of contents during future storage, handling, or transport
2. Place red biohazard bags for storage, handling, or transport in a rigid secondary container.

Rigid secondary containers must be leak resistant, have tight fitting covers and be kept clean and in good repair. Containers may be any colour and labelled with the words “Biohazardous Waste” or the international biohazard symbol and the word “BIOHAZARD” on the lid and on the sides so as to be visible from any lateral direction.

### **3.1.4 Storage and Transportation**

In order to avoid both the accumulation and decomposition of the waste, it must be collected on a regular daily basis to the area where the larger containers are kept before removal to the central storage area (Almuneef, Memish 2003).

Transportation to the central storage area is usually performed by using a wheelie bin or trolley. Wheelie bins or trolley should be easy to load and unload, have no sharp edges that could damage waste bags or containers and they should be easy to clean. Ideally, they should be marked with the corresponding coding colour (Bala, Narwal 2013b).

The central storage area should be sized according to the volume of waste generated as well as the frequency of collection. The facility should not be situated near food stores or food preparation areas. Its access should be always limited to authorised personnel, also it should be easy to clean, have good lighting and ventilation, designed to prevent rodents, insects or birds from entering. Storage time should not exceed 24-48 hours especially in countries that have a warm and humid climate (Pichtel 2010c).

External transport should be carried out using dedicated vehicles. They should be free from sharp edges, easy to load and unload by hand, easy to clean and disinfect, and fully enclosed in order to prevent any spillage in the hospital premises or at any point during transportation. The transportation should be always properly documented and all vehicles should carry a consignment note from the point of collection to the treatment facility.

Dedicated vehicles, trolleys or wheeled containers must be used for clinical waste. These must not be used for any other purpose. The containers must be cleaned at regular intervals sufficient to maintain cleanliness as well as after spillages/ leakages. The waste carrier must be registered with the Environment Agency for the collection, transportation and disposal of waste. The MOH must ensure that the contractor has a valid certificate. The Trust has a duty of care relating to the waste from generation, transport to ultimate disposal

### 3.1.5 Treatment and Final Disposal

The MW management can be done by treatment, recovery of useful materials, and modification of properties of the waste, making exposure less dangerous and enhanced environmental protection (Ahmed, Soni & Gupta 2013). Treatment of toxic and infectious waste is defined as any method, technique or process designed to change the biological character or composition of waste to render it non-toxic or non-infectious. Since landfill operations may cause loss of containment integrity and dispersal of infectious waste, it is recommended that all infectious waste be treated prior to disposal.

There are a number of different treatment methods (See Figure 3.2) and options to deal with medical waste including incineration, steam sterilisation (sanitation), microwave sanitation, chemical disinfection, dry heat disinfection, and disinfection with superheated steam (Demirbas 2011).

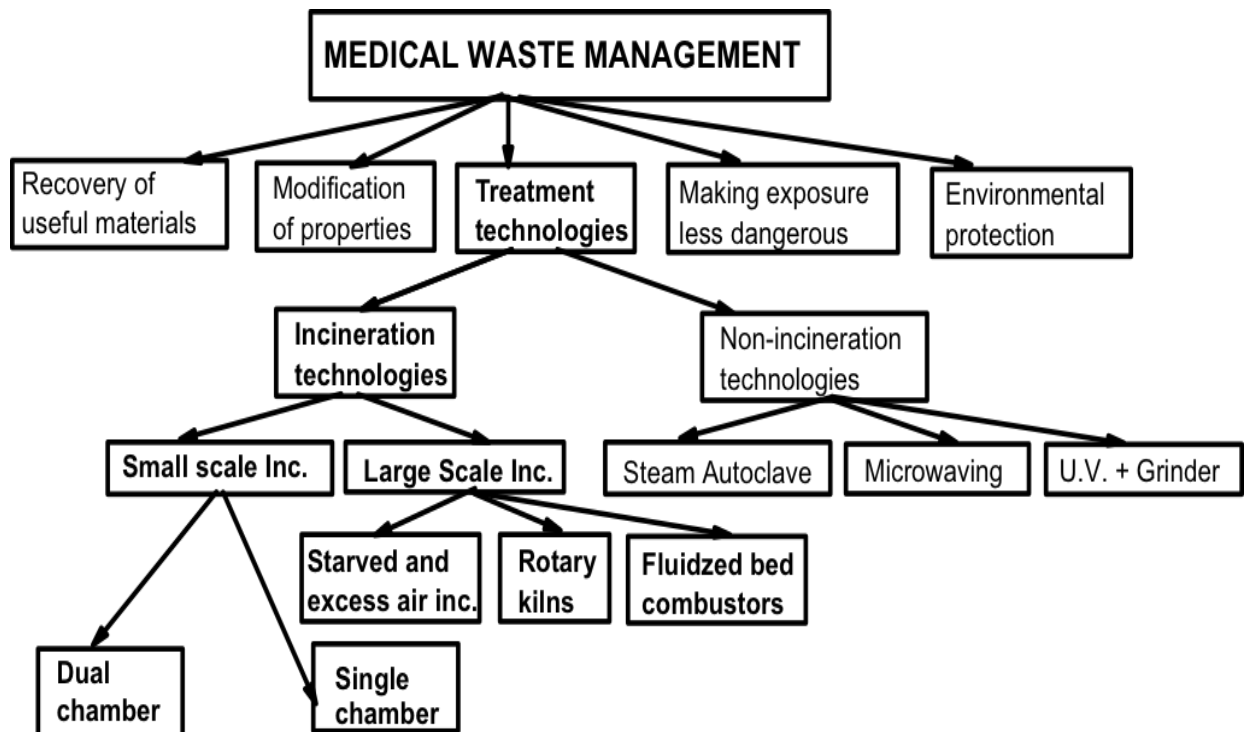

Figure 3.2: Medical waste treatment steps (Demirbas 2011)

However, the capital cost for incineration method is the highest. In addition, the operating costs are high due to the running cost of pollution control and waste preparation equipment. Other cost factors includes operating charges, sterilization efficacy, maintenance and higher operator skills. Air emissions, water emissions and the characteristics of treated waste are other factors that must also be considered. However, incineration is still the best technology to date due to several advantages, despite the fact that it cannot remove radioactivity in the wastes generated from X-ray laboratory.

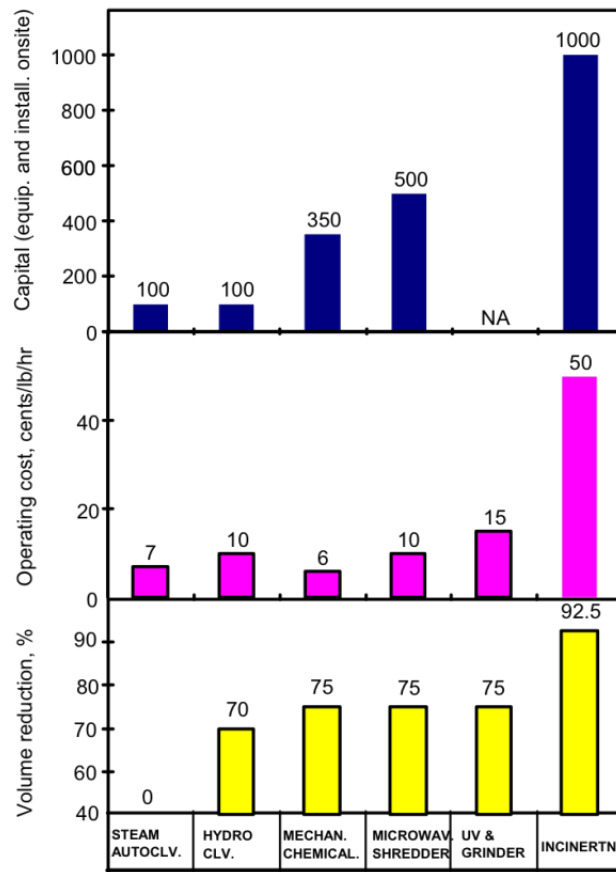

Figure 3.3: Comparisons of treatment technologies in terms of waste volume reduction operating charges and capital costs (Assamoi, Lawryshyn 2012).

When non-incineration methods are used for treatment of MW, further disposal problems must be solved because the volume is slightly reduced or almost constant (Assamoi, Lawryshyn

2012). The non-incineration technologies also achieve a less significant volume reduction of less than 90% of the medical waste treated compared to incineration which reduce above 90% of the medical wastes, as shown in Figure 3.3. The hydroclave, mechanical/chemical treatment, microwaving of shredded waste and irradiation of ground waste by ultraviolet rays, gives intermediate values for volume reduction, operating charges and capital cost.

The use of biological indicators to monitor the efficacy of a treatment method is important. Biological indicators selected to provide documentation of relative resistance to an inactivating agent should be chosen after evaluation of the treatment process as it relates to the conditions used during comparative resistance research studies. The degree of relative resistance of a microorganism to an inactivating agent can depend on various factors in particular temperature (Ahmed, Soni & Gupta 2013). Conditions used in literature studies that demonstrate a relatively high degree of resistance of a particular microorganism may be significantly different from the conditions found within a given treatment process.

Incineration and autoclaving have been the most widely employed methods of medical waste treatment. There are numerous advantages associated with incineration and its long history as an effective method of waste management have led to its worldwide use as the preferred means of treating and disposing of medical waste (Almuneef, Memish 2003). However, growing problems with air pollution, among other disadvantages to its application in medical waste treatment, have caused many government and agencies to introduce more stringent air-quality standards. Healthcare and other facilities that generate medical waste, have found that to meet these enhanced requirements through retrofitting existing incinerators or purchasing new equipment would be cost-prohibitive and have simply deactivated their incinerators.

## **3.2 Medical waste Treatment Technologies Used by Companies in KSA**

The medical waste treatment technologies which are used on all respondent hospitals in Riyadh city can be summarised as the following:

### **3.2.1 Autoclave**

The SEPCO Company implemented their design, which is locally manufactured autoclave called, SEPCO Clave. In the autoclave the infectious waste is sterilized with steam. For effective and efficient sterilization the degree of steam penetration is the most importance factor. SEPCO Clave high vacuum and high pressure systems ensure thorough and uniform penetration of steam into the biological waste to be treated. Thus, the waste is completely sterilized in autoclaves. Afterwards, the waste is shredded into unrecognizable reduced size.

### **3.2.2 Thermal Oxidation Unit**

All pharmaceutical products, drugs, drug residuals and therapeutic chemicals that have been returned from wards or have been spilled, out-dated, contaminated, or are to be discharged because they are no longer required are subjected to thermal oxidation. Any substance, liquid or solid which is toxic, corrosive, carcinogenic, mutagenous or genotoxic (Cytotoxics) waste can be treated by the thermal oxidation units fitted with air emission control system to comply with international environmental standard.

## **3.3 Alternative Technologies to Incineration for Clinical Waste**

There is a concerted move towards non-incineration technology, particularly for clinical waste. Some of the factors which have contributed to such a shift include:

- Increased awareness of the environmental and health impacts of incinerators
- Increased cost of incineration given increased equipment needs defined by new emission standards
- Difficulty in finding new sites for incinerators
- An increasing availability of non-incineration technologies

An example of an alternative technology is plasma technology, which has not been implemented yet in many countries, including Saudi Arabia. Interviews with local vendors in SA indicated that it is new technology that has not been looked at yet.

### **3.3.1 Plasma Technology**

Very hot plasma is formed by ionized gas (i.e. Oxygen, under normal pressure) in the strong electrical arc with the power ranging from 2 to 20 Mega Watts (Bosmans et al. 2012). Temperature of such plasma is very high, ranging from 2 to 6 thousand degrees Celsius. In such

high temperature, all waste constituents, including metals, toxic materials, silicon, etc. are totally melted forming non-toxic dross. Plastic, biological and chemical compounds, toxic gases yield complete dissociation (required minimal dissociation temperature is in the range of 1500 degrees Celsius) into simpler gases mainly  $H_2$  and  $CO_2$  (Kawai et al. 2010). Simpler gases, mainly  $H_2$  can be used as ecological fuel to generate heat energy and electrical energy decreasing significantly (even to zero) cost of plasma formation and waste utilization (Helsen, Bosmans 2010). Regained metals from dissociation process can safely return to metallurgic industry, and slag can be used as an additive to road and construction materials.

The utilization of municipal waste using this method does not cause the emission of foul odours and does not produce a harmful ash, which is something that normally takes place in an incinerating plant.

A plasma torch uses inert gases (steam) and metal (copper, tungsten, hafnium, zirconium, etc.) electrodes. Relatively high voltage source with high current is passed between two electrodes, spaced apart, creating an electrical arc (See Figure 3.4 a.). Pressurized inert gas is ionized when passing through the arc creating plasma. The temperature of the plasma torch can be in the range (2204–13871 °C). At these temperatures, molecules break down into basic elemental components in a gaseous form, and complex molecules are separated into individual atoms (Kawai et al. 2010). This molecular dissociation process using plasma is called plasma pyrolysis. The reactor operates at a slightly negative pressure, meaning that the feed system is complemented by a gaseous removal system, and later a solid removal system (See Figure 3.4 b.).

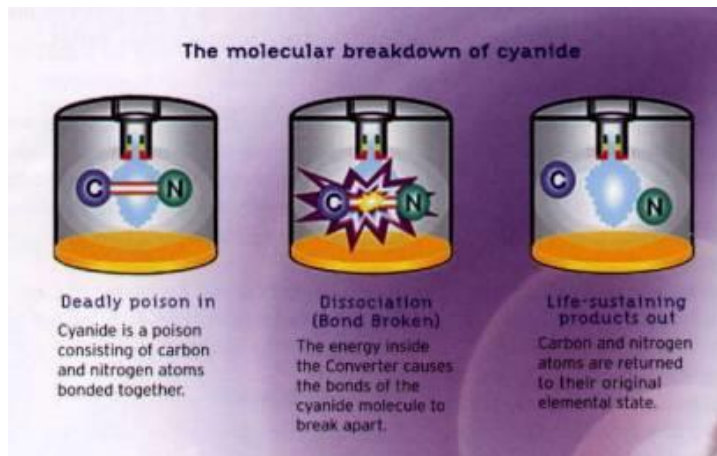
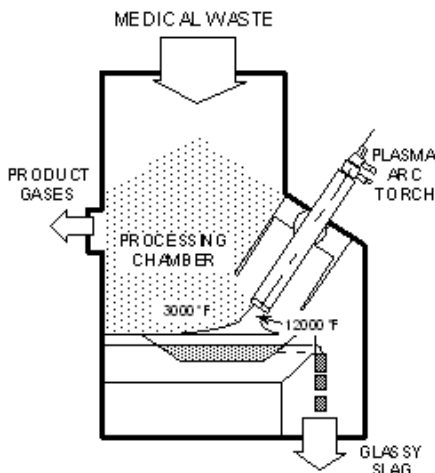

(a)

(b)

Fig.3.4 (a) Plasma based medical waste management system (b) Process of treatment

(Kawai et al. 2010)

Depending on the input waste (plastics tend to be high in hydrogen and carbon), gas from the plasma containment can be removed as syngas, and may be refined into various fuels at a later stage or fired on site to provide power. The process produces pure high-calorific syngas (CO, H<sub>2</sub>, CH etc.). Syngas produced from organic materials using plasma gasification has a conversion rate of greater than 99%.

A correctly selected temperature of plasma reaction and structure plasma of forming gas generates minimal content ballast products of oxidation (CO<sub>2</sub>, N, H<sub>2</sub>O, etc.). Other non-flammable inorganic components in the waste stream that are not broken down but only go through a phase change (solid to liquid) add to the volume of slag (including various metals) with minimal energy recovery and increased cost for refining. The metals obtained through plasma pyrolysis can be recovered from slag and used as commodity products in various applications. Inert slag could be granulated and subsequently used in construction. For efficient operation of the plant, a portion of the syngas may be used to run on site turbines to power the plasma torches and feed system.

### 3.3.2 Plasma Gasification for Waste Management

Plasma gasification is a process to convert organic matter into syngas using plasma processing (Byun et al. 2010). Plasma gasification technologies use an electric arc gasifier (plasma torch) to create a high-temperature ionized gas which breaks organic matter primarily into syngas and solid waste (slag) in a controlled vessel (plasma converter—either furnace or reactor) (Zhang et al. 2012). Its main use is as a waste treatment technology as it allows full decomposition and disintegration of organic components; however, it is also tested for the biomass and solid hydrocarbons, such as coal, oil sands, and oil shale, gasification. The process (shown in Figure 3.5) is intended to be a net generator of electricity, depending upon the composition of input wastes, and to reduce the volumes of waste being sent to landfill sites.



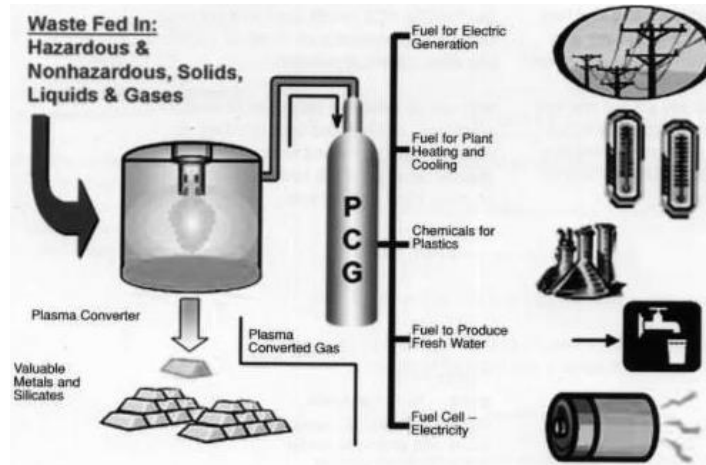

Fig 3.5: Use of plasma for toxic municipal waste (Byun et al. 2010)

### 3.3.3 Plasma Furnace for the Treatment and Disposal of Biomedical Waste

Plasma technology provides an effective and safe alternative for the treatment and disposal of Toxic Biomedical Waste, see Figure 3.6. The process destroys toxic components (germs, viruses, bacteria, etc.), incinerates organic constituents of waste and compact's mineral residual. Plasma furnace for treatment and disposal of biomedical waste has a capacity to process 50 kg/hour of waste and a plasma furnace requires additional 150 kW of Power after burning chamber (Chakraborty et al. 2013, Gautam, Thapar & Sharma 2010).



(a)

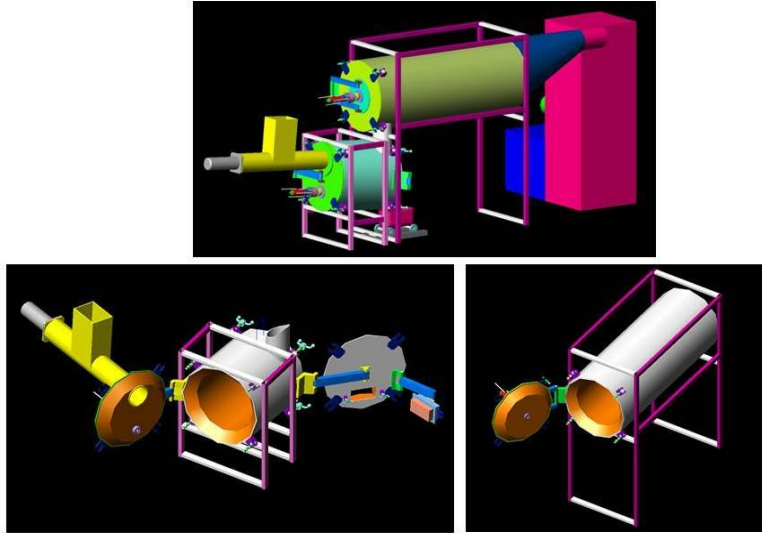

(b)

Figure 3.6: (a) Plasma arc torch PPT-100AC with a power of 100kW (b) Design details of plasma arc torch. (High Temperature Technologies Corp. Canada2009)

### 3.3.4 Plasma Furnace Process

The process of waste incineration is two-pronged is illustrated in Figure 3.7. First the waste is incinerated inside the furnace using plasma pyrolysis and then the leftover pyrogas is incinerated in an after-burning chamber, which is especially designed to include all the ecological parameters for effective incineration. It is impossible to achieve the same parameters for incineration in a furnace. Air plasma torches not only effectively pyrolyze waste, but also vitrify its ash slag at a temperature of 1500-1800 degrees of Celsius. The positioning of the plasma torches is designed in such a way so that plasma stream only comes into direct contact with the molten mass; refractory lining of the inner walls of the furnace remains untouched.

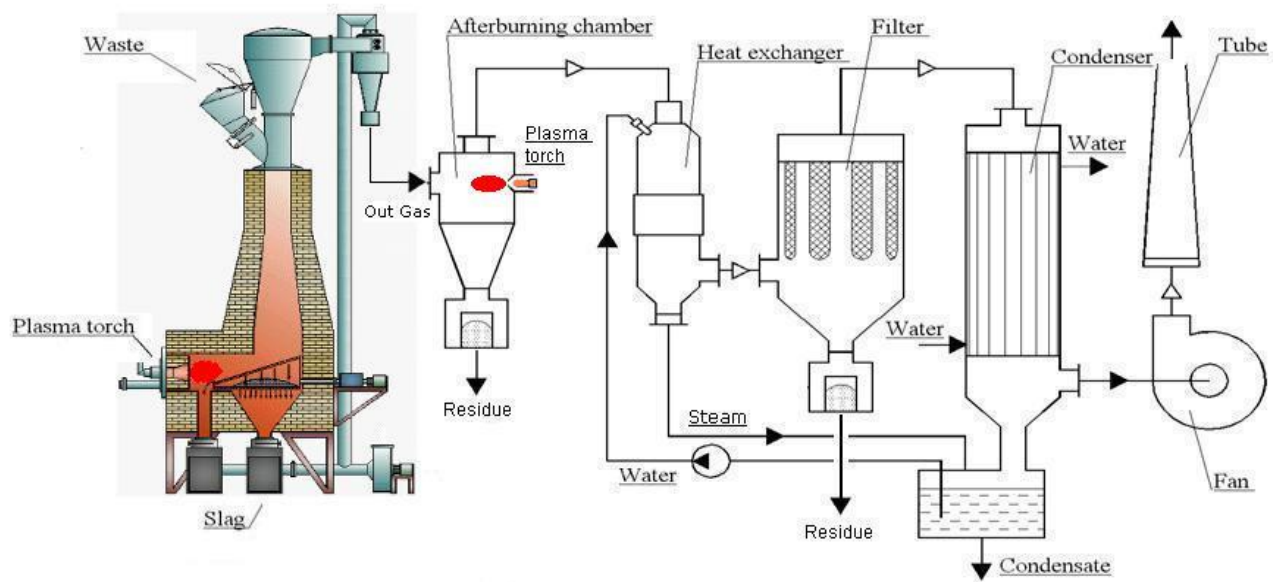

Figure 3.7: A complete plasma based medical waste treatment system (High Temperature Technologies Corp. Canada2009)

Waste is fed into a furnace through a feeding device. Waste is pyrolyzed at a temperature of 500-800 Degrees of Celsius. Furnace gas is partly comprised of volatile products of pyrolysis, and the resulting pyrogas has a high enough calorific value to be effectively incinerated in an afterburning chamber. The furnace provides an additional air supply and hence makes it possible to regulate this parity, depending on humidity and other physical and chemical properties of the waste.

### 3.3.5 Afterburning Chamber

Intensive intermixing of gas and air is achieved through cyclonic rotation of gas and air streams, and as a result exposure time of gas stream around the chamber is increased (see Figure 3.7). Operating plasma torch in a chamber ensures ignition and provides stable burning of furnace pyrogas at a temperature of up to 1200 Degrees of Celsius, even for a rather low calorific value of a pyrogas for this given temperature. In order to ensure a full incineration, this temperature is complemented with a great surplus of air, as well as a high – power plasma torch.

### **3.4 Advantages and Disadvantages of Plasma Technology**

Plasma method utilizes efficiently all four types of hazardous, toxic or lethal waste because of high temperature, capable of disassociating molecular bonds. Plasma waste utilization method takes place in a close system, without releasing ashes, waste remnants, dusts and toxic gases into environment. Regained metals return to metallurgic industry and created slag is used as an additive to road construction materials. Non-toxic gases, which are created, are stored in special containers (gas cylinders) and used as fuel and energy creators.

The volumetric waste reduction for most solid wastes is approximately 300 to 1. Where, conventional incineration ratio is in the range of 5 to 1 since large quantities of ash are produced. Plasma technology allows converting the large quantities of municipal waste in the range of 10 to 500 tons a day. This method of waste reduction is the only method available to reduce electronic waste, which does not undergo biodegradation.

The following are the main advantages of using plasma technology in medical waste management.

- The costs of using plasma technology are significantly reduced from \$40/ton to ZERO as a result of creation of ecologic by-products. The costs of using conventional incineration are in the range of \$100/ton.
- Contaminates in slag and gases created during plasma utilization with elements such as mercury, cadmium, sulphur, SO<sub>2</sub>, HCL, dioxins, selenium, chromium, lead, barium, arsenic, radioactive elements are strictly controlled by the usage of special water or dry scrubbers and filters. Using this method elements are considerably minimised below environmental standards. The remainder of the pollutants sinks into glassy slag and can be treated further in close system, which is a major distinction to conventional incineration.
- The ashes that are formed as a result of conventional incineration can be burned down to further using plasma technology to make them harmless.
- Contemporary plasma converters are computer controlled, safe, quiet and can be stationary or mobile.

Production of clean alloyed slag which could be used as construction material; Processing of organic waste allows production of combustible syngas which can be used in various applications, e.g. electric power and thermal energy generation; production of value-added products (metals) from slag.

A minor issue regarding plasma systems that rely on high temperatures for processing is the life of their liners. The refractory brick liner is an important aspect of separating the high interior temperatures of the plasma system from the [metal] shell of the plasma container. Liners are highly susceptible to both chlorine attack and to local variability in high temperatures, both of which would be found with typical municipal waste systems, and are not likely to last more than a year in service (but they are quickly refitted). One way to address this concern is by using the method demonstrated at the Trail Road Plant in Ottawa, Canada, which requires lower temperatures and a more robust material (fire brick) for a liner instead of the expensive and fragile metal.

The content and the consistency of the waste have a direct impact on performance of a plasma facility. Pre-sorting and recycling useful material before gasification provides a more consistent waste stream. A waste stream that is high in inorganic (metals and construction waste) increases the slag production and decreases the more valuable syngas production. Secondly, shredding the waste before entering the main chamber creates an efficient transfer of energy ensuring all materials are broken down.

Main disadvantages of plasma technologies for waste treatment are:

- Waste gasification and combustion ultimately releases carbon dioxide to the atmosphere instead of sequestering a large fraction of the carbon in a landfill
- Large capital costs relative to current landfills; requires large electrical energy input if the waste stream does not contain a large fraction of un-oxidized hydrocarbons
- The highly corrosive plasma flame may lead to frequent maintenance and component replacement with associated facility down time
- The filters and gas treatment systems are themselves sources of toxic waste, some of which (e.g. acidified water) are poor candidates for plasma processing.

### **3.5 Summary of the Chapter**

In this chapter, incineration technology has been reviewed the major plasma based technologies has been reviewed critically. In conclusion it is found that the plasma processing for waste treatment is an ecologically clean process. The lack of oxygen and high temperature in a plasma reactor prevents the main elements of gas from forming toxic compounds, such as furans, dioxins, NO<sub>x</sub>, or sulphur dioxide. Extensive filtration removes inorganic residue such as ash and gaseous pollutants such as NO, HCl, and H<sub>2</sub>S. This process allows the production of ecologically clean synthetic gas and gaseous compounds which do not contain any phenols or complex hydrocarbons. Plasma arc facilities have been constructed at municipal-scale waste disposal in numerous worldwide locations, including for landfill mining that will return landfills to their original state. However, the use of plasma for medical waste management will also have a significant role to destroy medical, and hazardous waste.

This chapter investigated several practices and developed technologies, which have been applied in KSA medical sector. As such, a proposal for the stakeholders was presented to be considered according to the quality low level that was found generally ( as in the case study) in the provided services regarding waste management. This chapter presented the possible technologies and waste management practices from a scientific and industrial point of view, by studying their operational stages, advantages, disadvantages, and their impact from an industrial efficiency angle. Therefore, it is essential to develop a framework for the future features of the waste management technologies in Saudi Arabia.

Chapter 4 next will focus on the research methodology employed to develop a framework for the future, which is expected to standardise the medical waste management in hospitals in Riyadh city, Saudi Arabia.

# Chapter 4: Research Methodology

---

This chapter discusses the rationale of the research methodology adopted for this thesis. The first section outlines the philosophy that supports the quantitative approach taken with this research. The design steps of research questioner is also presented and discussed in this chapter.

The methodology for conducting this research is illustrated in Figure 4.1.

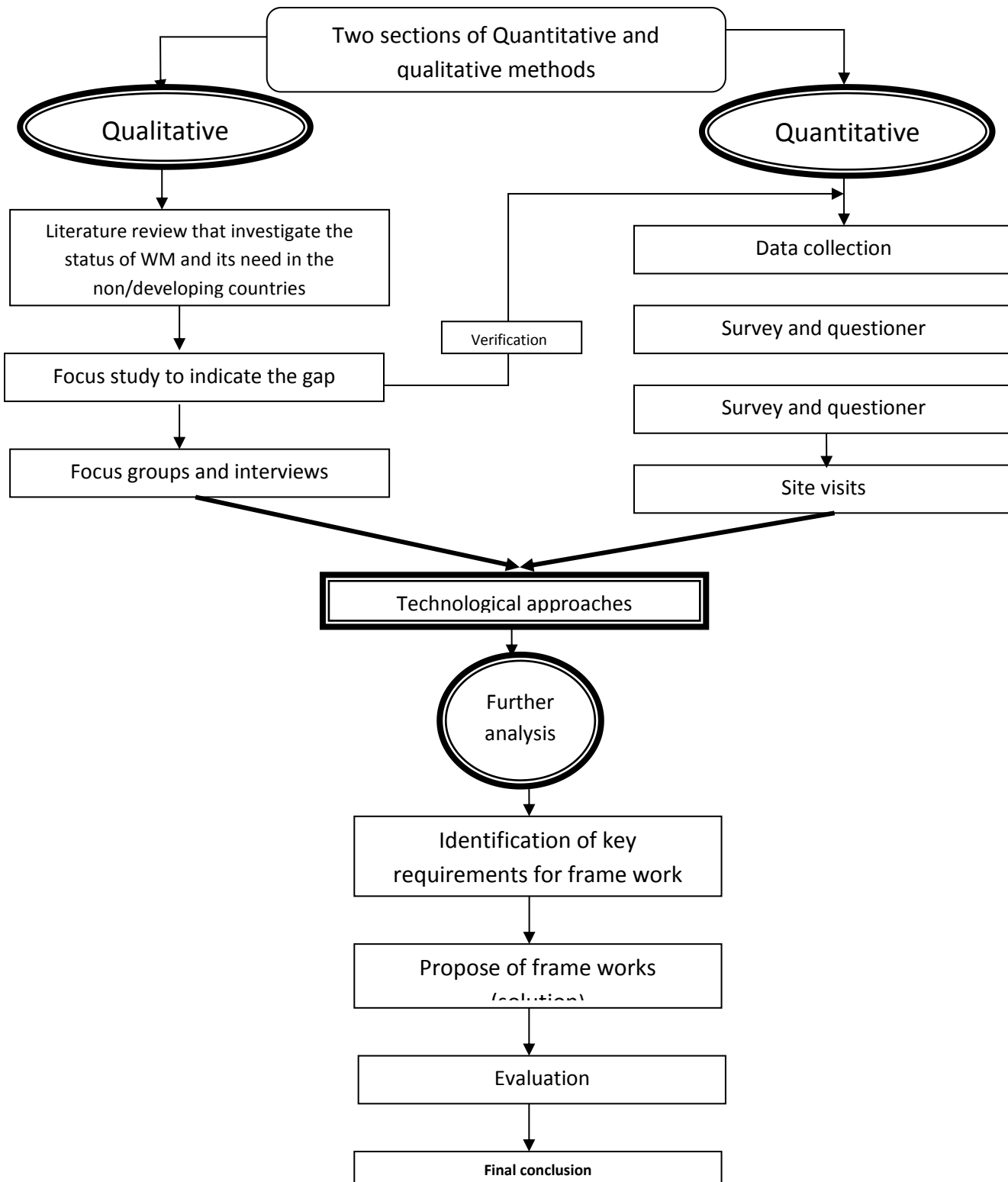

Figure: 4.1 Research Methodology



## **4.1 Hospitals Survey**

The methodology adopted for this research is quantitative and in that the questioner used an instrument to collect the data from the authorities of the healthcare facilities and with personnel involved in the management of the wastes. The information was collected using different questioners, specifically developed for the research. Site visits were conducted to support and supplement information gathered in the survey. These visits were helpful in obtaining information about common practices in the management of the wastes. The forms contain information on the generation of waste and main aspects of segregation, collection, internal and external storage, transport, treatment, cost of the medical waste management and final disposal. The data also collected from private companies responsible for collection and disposal of medical wastes and from health officials. This study was carried out in government and private hospitals in Riyadh city during February 2009- April 2009, depended on the various methods of data collection as outlined.

### **4.1.1 Developing a Research Questionnaire**

Two different set of questionnaire's were prepared and revised after discussion with the research supervisors. The questionnaires are available in appendix A and B of this thesis. The main questionnaire has been developed for medical staff responsible for medical waste in each hospital. The questionnaire aimed at gathering information about the generation, segregation, collection, internal and external storage, transportation, treatment and disposal of medical waste in government and private hospitals in Riyadh city. The second questionnaire has been developed as an interview questionnaire that would test medical staff preparedness and attitude towards medical waste management (section 4.2). The answers have been introduced through personal interviews and not in a wide range as the first questionnaire r. This questionnaire was aimed to enhance the framework development with more details regarding the cultural side of the medical sector as well as behaviour of the medical staff. As such, important factors have been incorporated and reflected at the end of the proposed framework.

The main questionnaire consists of five parts (Figure 4.2) for focusing and gathering information mainly at several issues as generation of medical waste, collection, internal and external storage, transportation, treatment and final disposal of medical waste in primary health care centres and private hospitals in Riyadh city. The key persons, the cleaners and sanitary workers were

personally interviewed during March / April-2009 in order to gather additional information about the current practices in the medical waste management in Riyadh city. The questionnaires were based on WHO model, and reformatted with modifications to be compatible to the organization of health facilities in the Kingdom of Saudi Arabia.

#### 4.1.1.1 Section A: General Information

This section was designed to obtain general information. This includes the name and position of the respondent.

#### 4.1.1.2 Section B: Activity Measurement

The section was designed to collect data on the activity that would have an impact on the medical waste generated. For hospitals, it included number of beds, percentage occupancy and number of outpatients treated per month. For individual practitioners, it included the number of patients treated per month, number of blood tests and other diagnostic test conducted as well as number of injections administered.

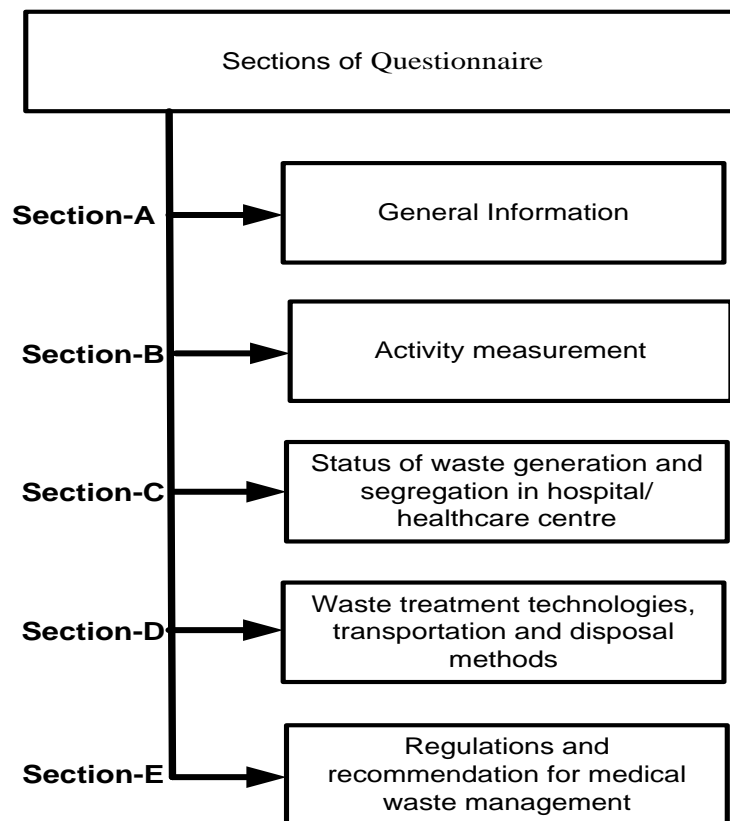

Figure 4.2: Sections of Questionnaire developed for survey

#### **4.1.1.3 Section C: Status of Waste Generated & Segregation**

This section was designed to collect data on the amount of total waste and the amount of medical waste collected at the facility as well as collect information about the segregation of waste, and what types were segregated. The term medical waste used in this survey corresponds to the definition of medical waste listed in EPA's Medical Waste Tracking Act (3), which also used on the guidelines of health care waste management prepared by Ministry of Health of Saudi Arabia.

#### **4.1.1.4 Section D: Treatment Technologies, Transportation and Disposal of Waste**

This section of the questionnaire was designed to collect information about the treatment of the medical waste, and how it was treated and the cost of treatment and disposal of waste.

#### **4.1.1.5 Section E: Regulations and Recommendations**

This section was designed to collect information about the local and international regulations that affect the disposal and treatment of medical waste. A generators awareness of regulation indicates how many of the generators know about the regulations and what they cover, also the questioner asks for any recommendation they may have.

### **4.2 Qualitative questionnaire for medical staff**

A portion of research devoted to collect and analyze findings related to hospitals in Riyadh, questionnaires and interviews were conducted with medical staff representing most departments and are dealing or have dealt with medical waste. That would include doctors, nurses, pharmacists and lab technicians working in the main hospitals in Riyadh city, in order to gather findings related to medical staff or certain departments real practices, the degree of awareness, enforcement, etc...The interview questionnaire sheet has been designed of two sections (Figure 4.3); section A: general information and section B: closed ended questions with YES or NO answers; to test medical staff preparedness and attitude towards medical waste , the interview sheet is available in appendix B.

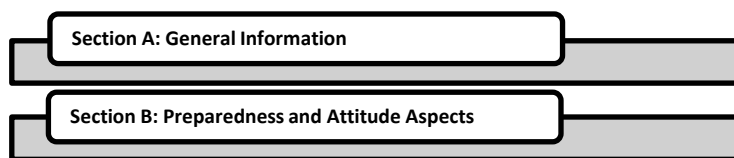

Figure 4.3: Preparedness and Attitude - interview structure

### 4.3 Methodological Approach for the Development of Framework

The design of the framework has emerged after analysing the finding from literature and the earlier studies as illustrated in Figure 4.4, which exposed a number of issues relating to medical waste management. These findings have been analysed and translated into sets of requirements, which the framework intended to satisfy. Following that the framework has been evaluated by special committee to accomplish the final shape. The detailed description of the evaluation and results are presented in detail later (see section 6.1).

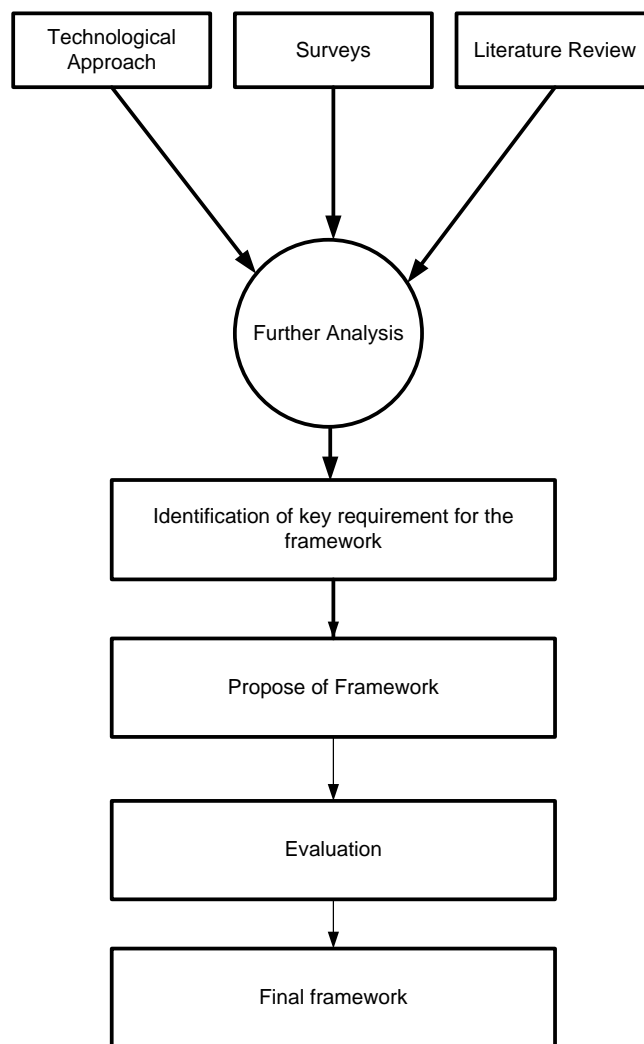

Figure 4.4: Methodological Approaches for the Design of Framework

#### **4.4 Piloting, Data Collection and Analysis**

In order to ensure the clarity of questions in all phases of the research, and to make sure technical terms and the language of the designed questionnaire are well-understood, members of the research group (other PhD researchers volunteered) have assisted in conducting a pilot assessment before conducting the final study. The questionnaires have been explained to the members of the research group in order to distribute them to the wide range of studied sectors. Researchers have been chosen to assist in reviewing the pilot study in order to guarantee the level of trust and quality in reaching the studied areas and to ensure a high level of understanding for the questionnaire from the targeted research parts. The Data has been collected using hard copies then analysed using SPSS software. The findings are presented accordingly in section 5.3.

#### **4.5 Summary of chapter**

This chapter presented the research methodology for the whole research project. The way it is structured was in accordance to each task. The work has been accomplished, through a number of research tasks, to achieve each objective as well as the main aims of the intended research work. The following chapter deals with hospital survey.

# Chapter 5: Hospitals Survey and Corresponding Waste Management

---

This chapter presents a survey conducted in governmental and private hospitals in Riyadh. The study was conducted in different health care settings. The Data were collected from various hospitals in Riyadh city. The main tools used in data collection were questionnaires; other data has been collected from other published recourses. Questionnaires were distributed to different health facility workers in different departments of the selected health facilities.

## 5.1 Current Status of Facilities in Health Care Units

According to the report of Ministry of Health in Saudi Arabia, there are 362 health care units in Riyadh city. In these health care units, there are 12696 total numbers of beds and 2727 physicians. In Riyadh city the most number of hospital beds are in east and central region, the majority of these hospitals (22 out of 40) are government hospitals (55 %) and the remaining 18 are private hospitals (45 %). There are 87 primary health care units and the rest are a mixture of other types as seen in table 5.1

Number of health care units	362
Number of beds	12696
Number of physicians	2727
Number primary health care units	87
governmental hospitals	22 out of 40 (55%)
private hospitals	18 out of 40 (45%)

Table 5.1: Current Status of Facilities in Health Care Units in Riyadh city (report of Ministry of Health in Saudi Arabia, 2006).

## 5.2 Survey Sample

A total of 30 (100%) surveys were sent to hospitals in Riyadh city, all of these surveys were returned. 50 % (15 of 30) of the respondents said that they were privately owned hospitals, and the other 50% (15 of 30) reported that they were government owned. 76.6% (23 of 30) of the respondents classified themselves as practicing general medicine and surgery, 6.6% (2 of 30) of the surveyed hospitals classified themselves as psychiatric facilities, 3.33% (1 of 30) classified themselves as rehabilitation Centre, 6.6% (2 of 30) classified themselves as obstetrics/gynaecology facilities, and 6.6% (2 of 30) classified themselves as other medical facilities.

Number of hospitals	Activities	Percentage
23	general medicine and surgery	76.6 %
2	psychiatric facilities	6.66
2	Other medical facilities.	6.66
2	obstetrics/gynecology facilities	6.66
1	rehabilitation Centre	3.33

Table 5.2: The activities of hospitals surveys

The 30 hospitals have chosen in different parts of Riyadh to cover the whole geographical areas of the city, and to include most of the specialisations for the hospitals in the country. Number 30 samples of hospitals have been reached to cover the following:

- Most of the geographical areas in Riyadh
- Most of the types and specialisations of the hospitals in order to include most medical wastes types and classifications
- The study covered both types of hospitals from the management side ( as private and governmental hospitals)
- Hospitals are included in the research as they are more productive for wastes comparing and more general comparing to the other medical units.
- More samples number was aimed high as possible to ensure the accuracy.

The surveyed sites represent the largest and most busy hospitals in Riyadh city where the study included half of them as governmental and the other half are private sector, where the

management type in both of the hospitals varies from the level of quality which would be reflected on the level of dealing with the medical waste and its management. The names of the private and governmental hospitals that have been surveyed are included in table 5.3

Government	Private
Amal	Saultan
KSH	National
KAUH	Hamady
KFMC	Moasah
Yamamah	Meshary
Military	Obaed
Eman	COSE
Force	Green-cr
King Saud	Mubark
Salman	German
KUH	Kingdam
N-Guared	Falah
KKEH	Dallah
Military2	Habieb
KFSH	Eligent

Table 5.3: name of hospitals that have been surveyed in Riyadh city

The answers to the questionnaires from the returned survey forms were collected and entered to the PC using the Statistical Package for the Social Sciences (SPSS ver. 17) software as well as Microsoft Excel software to perform descriptive and inferential statistics. Descriptive statistics



used a percentage to summarise the characteristics of the participated group (copy is attached in the Appendix c). The data gathered from the questionnaire was compiled with a computer and were analysed using statistical excel and SPSS software.

## **5.3 Findings**

### **5.3.1 Activity Measure**

All hospitals were asked to provide the following data; the number of inpatients admitted on a monthly basis, the percentage occupancy of the beds and the number of outpatients treated in an average month. The average number of inpatients admitted on a monthly basis by the participating hospitals is 12,236 patients. It was found that the average for a typical governmental hospital is 19,194 patients, whereas for a private hospital is 5,278 patients. In addition, the survey has shown that the average number of outpatients admitted on a monthly basis by government hospitals in Riyadh city is 14,800 as in Table 5.4 and that by private hospital is 4,168 as in Table 5.5.

The maximum number of patients served per day in Riyadh city governments hospitals was (2000) the minimum number being (10) patients per day. The average number of patients served in Riyadh private hospitals per day is (2084.3).

The higher the number of patients served per day the higher the amount of medical waste generated, hence increased chances of transmission of infectious diseases and the higher the rate of environmental pollution, if the waste generated is not properly monitored.

<b>Name of hospital</b>	<b>No. Outpatients per month</b>
Amal	300
KSH	2000
KAUH	2000
KFMC	15000
Yamamah	1500
Military	20000
Eman	7000
Force	8000
King Saud	10000
Salman	10000
KUH	60000
N-Guared	50000
KKEH	1200
Military2	25000
KFSH	10000
<b>Total</b>	<b>222000</b>

Table 5.4: No. of outpatients per month in government hospitals

<b>Name of hospital</b>	<b>No. Outpatients per month</b>
Saultan	500
National	4800
Hamady	3600
Moasah	3000
Meshary	4500
Obaed	2800
COSE	4500
Green-cr	1000
Mubark	2800
German	4500
Kingdam	1000
Falah	3500
Dallah	15030
Habieb	10000
Eligent	1000
<b>Total</b>	<b>62530</b>

Table 5.5: Number of outpatients per month in private hospitals

### 5.3.2 Waste Generation

The results of the study have revealed that general waste makes up at least 83.6% of all waste generated at the surveyed medical facilities as in Figure 5.1. This waste is no different from

general household or office waste which may include paper, plastics, liquids and any other materials that are not potentially infectious.

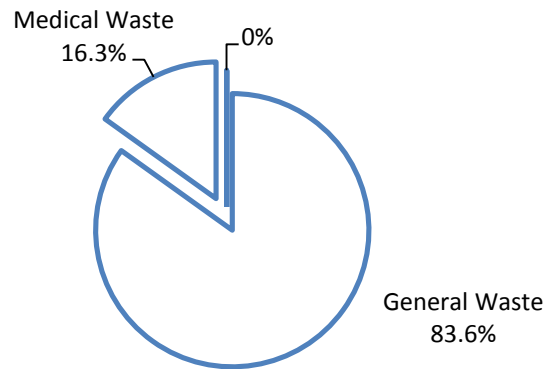

Figure 5.1: Percentage of medical waste generated in hospitals

Figure 5.2 shows the general and medical wastes generated by governmental hospitals in Riyadh. The quantities of general and medical wastes generated by private hospitals in Riyadh are shown in Figure 5.3.

The World Health Organization (WHO) estimated the total medical waste per person per year is anywhere to be from 0.50 to 3.00 kg/bed/day in both developing and less developed countries. The study has shown that the total medical waste generation rate for government hospitals is about 4733.19kg/day, representing an average of waste generation rate of 0.5kg/bed/day. While the total medical waste generation rate for the private hospitals is in the region of 2107kg/day, giving an average of waste generation rate of 0.75kg/bed/day. These figures are in good agreement with estimate given by WHO.

It can be seen that the quantities generated vary from hospital to hospital and depend on the type of health-care facility and local standard conditions. In each hospital, the quantities of waste were physically weighed in specialized units; the quantities are based on 90% bed-occupancy.

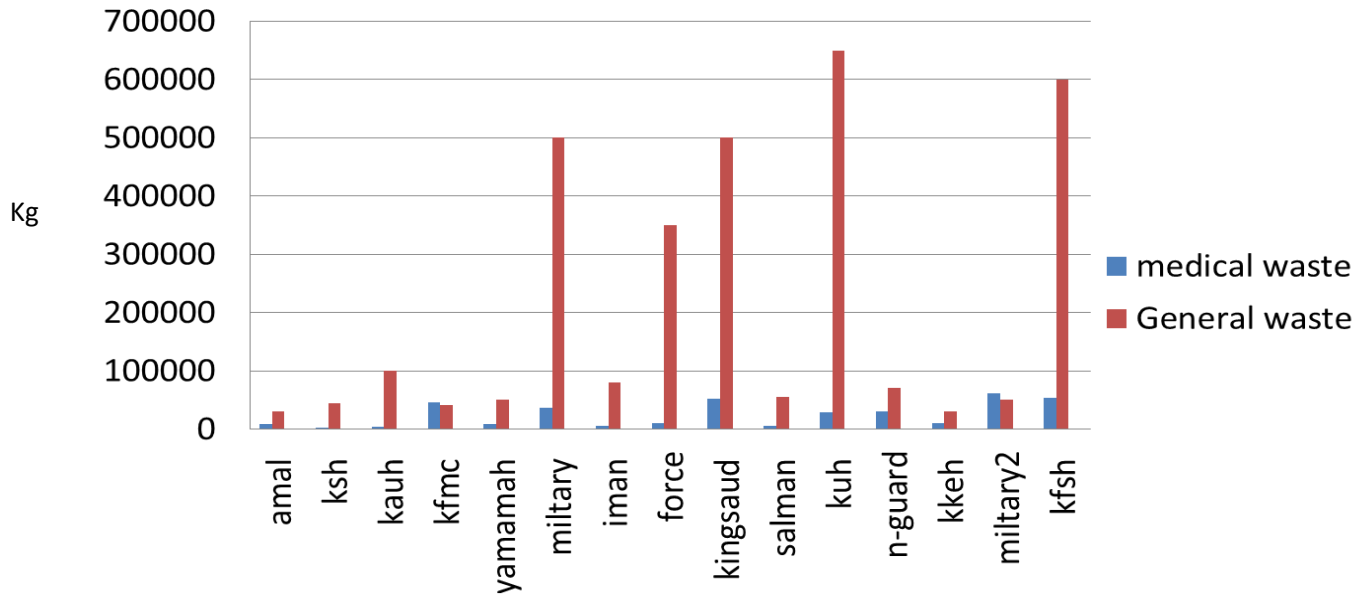

Figure 5.2: Quantity of general and medical wastes generated in government hospitals

The exact quantity of medical waste produced by health care facilities such as general hospitals, medical centres, operating rooms and medical laboratories should be determined in order to develop a good waste management system. Besides, the amounts of different categories within medical waste have to be identified (see Figures 5.4 and 5.5). This was achieved by telephone conversations with hospital authorities, interviews with hospital managers and medical waste handlers, and by physical checks.

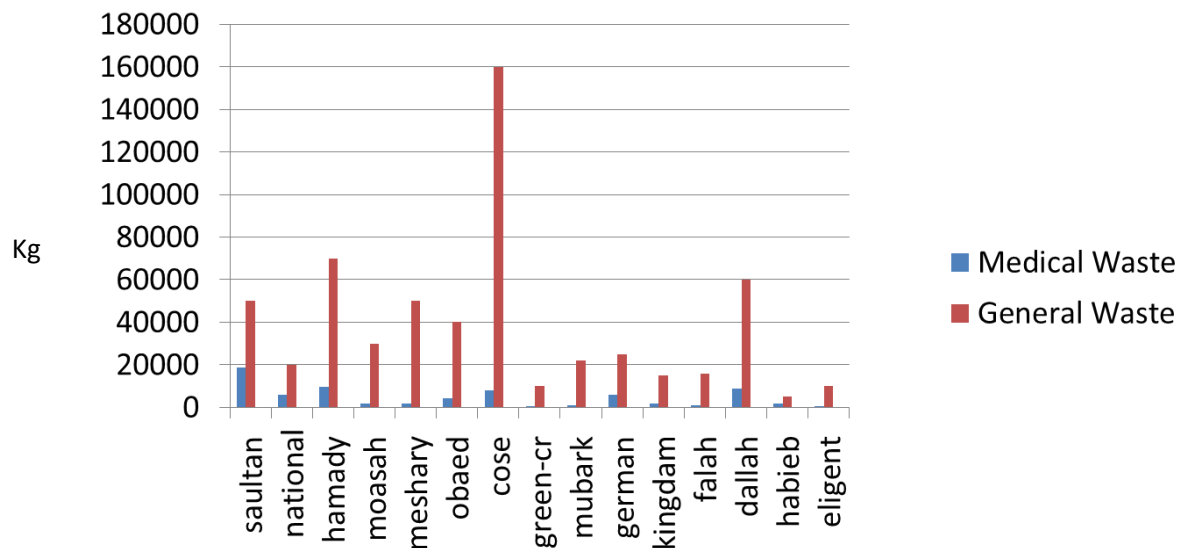

Figure 5.3: Quantity of general and medical wastes generated in private hospitals

Normally health care wastes are categorised into two types such as infectious and non-infectious. In this study, the term “medical wastes” refers to all types of potentially hazardous waste. Infectious waste includes all those medical wastes, which have the potential to transmit viral, bacterial or parasitic diseases. It includes both human and animal infectious wastes and waste generated in laboratories and veterinary practice. These wastes are hazardous in nature. Non-infectious wastes are generated from packaging, food preparations and visitors activities. This waste is large compared to infectious waste. . As shown in figures 5.1 to 5.3. All hospitals covered by this survey have generated much more general waste than medical waste.

The survey revealed that the total quantity of general waste generated by 30 hospitals is about 37715.3 kg/day. The survey has also indicated that the total medical waste generated is about 6840.19kg/day. The daily quantity of general and medical wastes generated by each government hospital is shown in Table 5.6, and that for private hospitals are presented in Table 5.7.

The percentage estimate of the medical waste that can be considered as medical waste of Type or group A-H of the total hospital waste generated, approximately 11.3% is hazardous, 83.6% is general (non-risk) waste while a small percentage (5%) is labelled as highly hazardous. There are different estimates regarding the share of hazardous and non-hazardous constituents of healthcare waste. The percentage of 10 -25 % of healthcare waste is regarded as hazardous

(medical waste) and may create a variety of health risks. While the pathological and infectious waste represent 15% sharps, chemical and pharmaceutical waste represent 1% and 3% of the general waste respectively. Less than 1% is considered as special waste such as radioactive or cytotoxic waste pressurized containers or broken thermometers and used batteries (Harhay et al. 2009).

Name of hospital	General waste (kg/month)	General waste (kg/day)	Medical waste (kg/month)	NO.bed	mw\day kg	w\day\bed kg
Amal	5000kg	166.6	1000kg	502	33.33	0.066
KSH	7800kg	260	2850kg	130	95	0.73
KAUH	7500kg	250	2000kg	220	66.66	0.3
KFMC	106200kg	3540	18200kg	1095	606.6	0.55
Yamamah	42000kg	1400	7000kg	300	233.3	0.7
Military	86400kg	2880	14400kg	1200	480	0.4
Eman	18400kg	613.3	2700kg	215	90	0.42
Force	23400kg	780	3900kg	430	130	0.3
King Saud	90000kg	3000	18000kg	1094	600	0.54
Salman	31500kg	1050	4500kg	264	150	0.56
KUH	60000kg	2000	15000kg	780	500	0.64
N-Guared	70000kg	2333.3	15000kg	690	500	0.56
KKEH	21000kg	700	4000kg	300	133,3	0.44
Military2	128100kg	4270	18300kg	1200	610	0.5
KFSH	106050kg	3535	15150kg	990	505	0.5
<b>Total</b>	<b>803350kg</b>	<b>26778.2</b>	<b>142000 kg</b>	<b>9410</b>	<b>4733.19</b>	<b>0.50</b>

Table 5.6: Quantities of waste generated by government hospitals

Name of hospital	General waste (kg/month)	General waste (kg/day)	Medical waste (kg/month)	NO. bed	mw\day kg	w\day\bed kg
Saultan	28080kg	936	7020kg	450	234	0.52
National	12600kg	420	1800kg	124	60	0.48
Hamady	42000kg	1400	6000kg	325	200	0.6
Moasah	18000kg	600	2250kg	160	750	0.46
Meshary	10800kg	360	1800kg	140	60	0.42
Obaed	17640kg	588	2440kg	200	98	0.40
COSE	38400kg	1280	4800kg	300	160	0.53
Green-cr	8000kg	266.6	1200kg	55	40	0.72
Mubark	7800kg	260	1300kg	94	43	0.46
German	20000kg	666.6	3000kg	300	100	0.33
Kingdam	5000kg	166.6	1000kg	100	33	0.35
Falah	6000kg	200	990kg	50	33	0.6
Dallah	26400kg	880	6600kg	360	220	0.61
Habieb	82000kg	2733.3	1380kg	100	46	0.46
Eligent	5400kg	180	900kg	50	30	0.6
<b>Total</b>	<b>328120</b>	<b>10937.1</b>	<b>42480</b>	<b>2808</b>	<b>2107</b>	<b>0.75</b>

Table 5.7: Quantities of waste generated by private hospitals

In literature the waste generated in hospitals is usually given in terms of kg /occupied bed/month. The same method is used here to represent the waste generated by the respondents. It was found that the average total of general waste and medical waste generated by government hospitals in Riyadh city was 945350 kg/occupied bed/month. While, private hospitals generated 370600 kg/occupied bed/month of total waste.



Using only the values given by hospitals, we found the average percentage of medical waste generated by government hospitals in Riyadh city to be 17.67% of their total waste. For private hospitals, it was only 12.94%. The average occupancy rate for all respondents in this survey was 92.22%.

### **5.3.3 Type of Waste Generation**

The World Health Organization categorizes medical waste into:

- Sharps
- Infectious
- Pathological
- Radioactive
- Pharmaceuticals
- Others (often sanitary waste produced at hospitals)

Accordingly, medical waste consists of solids, liquids, sharps, and laboratory waste that are potentially infectious or dangerous and are considered a threat to the community and the environment. Infectious wastes was described as “biohazardous”, “health-services hazardous”, “pathological”, “biological” and “hazardous infectious” (Meaney and Cheremisihoff, 1989). However, the term medical waste used in this survey corresponds to the definition of medical waste listed in EPA’s (Environmental Protection Agency) Medical Waste Tracking Act (3) which also used on the guidelines of health care waste management prepared by ministry of health on Saudi Arabia. Under these regulations and guidelines, medical waste may include the following:

- Cultures and stocks of infectious agents and associated biological (Type A)
- Blood, blood products and body fluids (Type B)
- Pathological wastes consisting of tissues, organs and body parts (Type C)
- Sharps including needles, syringes etc. (Type D)
- Carcasses, body parts , bedding of animals exposed to pathogens (Type E)
- Waste from rare, unusual or highly communicable diseases (Type F)
- Dialysis waste (Type G)
- other discarded material associated with patient care (Type H)

In some cases it was evident that the percentages were given in terms of the total waste rather than in terms of the medical waste. In such cases, the percentages were corrected to reflect the appropriate percentage of the medical waste generated in each category. Those percentages that could not be corrected were left in the database as they indicate the type of wastes generated in hospitals as seen in table 5.8 and 5.9. The survey shows the percentage of each type for the surveyed government hospitals. Sharpies (type D) constituted the highest percentage (ranging from 20 to 50 %) of the generated medical waste. The second highest percentage is type C (ranging from 10 to 40 %).

The hospitals were asked to estimate the percentage of medical waste they generate in different categories, namely Type A, Type B etc. It can be concluded that 87.9% (12 of 15) of the government hospitals generated Type D and Type C waste. 84.9% (11 of 15) generated Type A, Type B and Type F waste, 66.7% (9 of 15) generated Type H while 45.5% (7 of 15) generated Type E waste. Only 9.1% (1 of 15) generated Type G waste.

Number of Hospitals	Waste Categories	Average Percentage
12	Type D and Type C waste	87.9%
11	Type A, Type B and Type F waste	84.9%
9	Type H	66.7%
7	Type E waste	45.5%
1	Type G waste	9.1%

Table 5.8: waste categories for government's hospitals

For the private hospitals we calculated the average percentage of medical waste in different waste categories to be 87.9% (12 of 15) of the private hospitals generated Type D and Type A waste. 84.9% (11 of 15) generated Type C, Type B and Type H waste, 66.7% (9 of 15) generated Type F while 45.5% (7 of 15) generated Type G waste. Only 9.1% (1 of 15) generated Type E waste.

Number of Hospitals	Waste Categories	Average Percentage
12	Type C, Type B and Type H waste	87.9%
11	Type A, Type B and Type F waste	84.9%
9	Type F	66.7%
7	Type G waste	45.5%
1	Type E waste	9.1%

Table 5.9: waste categories for private's hospitals

As can be seen from the above results, Type D waste is the largest amount of waste produced. Equal amounts of Type B, Type C and Type A are generated. The amount of Type A produced is a little less than that of Type b. Amount of Type F, Type G and Type E wastes generated are very small.

It is noticed that sharp medical waste production represents the highest percentage among the generated medical wastes in all targeted healthcare units with a percentage 76.5 % of a total targeted group. While the healthcare unit's production of the medical wastes from heavy metals represents the lower percentage (3%) of the total. Also, 4.2 %, of healthcare units produce radioactive materials

The above results are plotted in Figure 5.4 for the government hospitals and in Figure 5.5 for the private hospitals. It can be noticed that the total percentages for type A and type B are equal for the government hospitals. The findings of this study showed that Type E and type G are constituted the lowest quantities for both government and private hospitals. The waste generated by psychiatric and other types of hospital was different from that of the one generated by general hospitals. Two of the respondents categorised themselves as psychiatric or other hospitals.

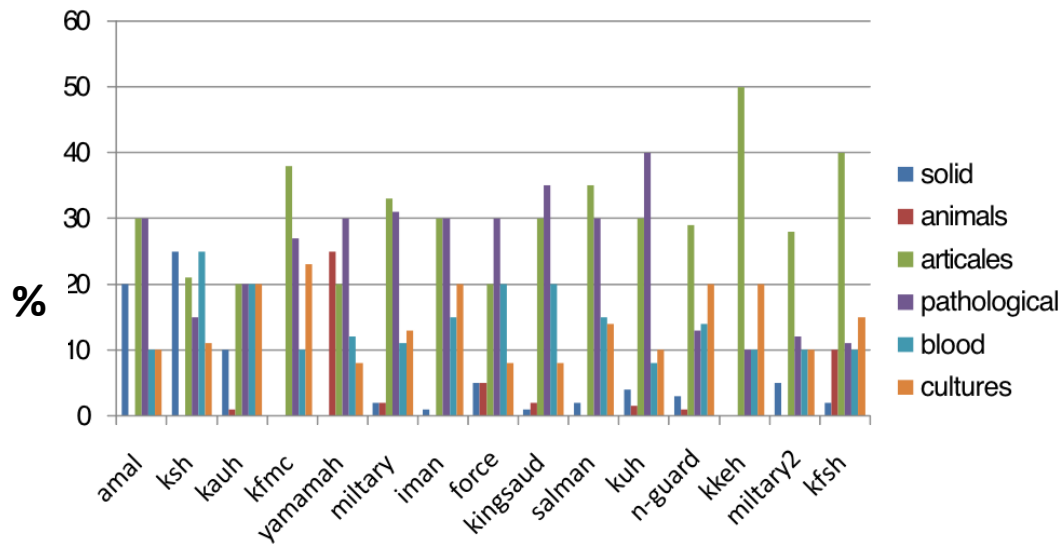

Figure 5.4: Types of medical waste for government hospitals

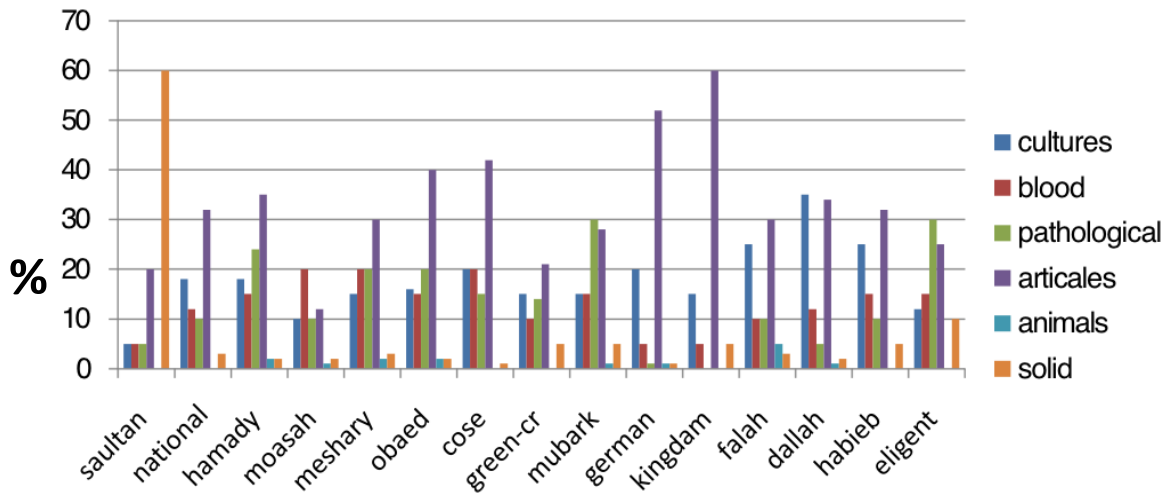

Figure 5.5: Types of medical waste for private hospitals

The hospitals were also asked to list the sources of medical waste in terms of the wards in which they were generated. Each department in the health facility generates a certain amount of waste which varies depending on the activities carried out in the particular department. Also investigations were made to know if there are any protective gears used during handling of the waste.

Hospital Name	First wards	Second wards	Third wards	Fourth wards	Fifth Wards
Amal	Outpatient	ER	Lab	OR	ICU
KSH	ER	OR	LAB	ICU	Outpatient
KAUH	OR	ER	LAB	ICU	Primary clinic
KFMC	OR	Ob-Gyn	ER	LAB	ICU
Yamamah	Ob-Gyn	Lab	OR	ICU	Outpatient
Military	OR	Lab	ER	Ob-Gyn	Lab
Emen	ER	OR	Lab	Ob-Gyn	Outpatient
Force	OR	ER	Ob-Gyn	Lab	ICU
King Saud	LAB	Outpatient	OR	ICU	ER
Salman	ER	OR	LAB	Ob-Gyn	ICU
KUH	OR	Ob-Gyn	ER	Lab	ICU
N-Guared	OR	Ob-Gyn	ER	Lab	CCU-ICU
KKEH	Lab	Outpatient	OR	Inpatient	ER
Military2	OR	ER	CCU	Ob-Gyn	ICU
KFSH	OR	Lab	ICU	Research	ER

Table5.10: Wards that generate the most medical waste in government hospitals.

*For the government hospitals:*

According to the survey results, the OR was most frequently listed as the largest source of medical waste while ER was cited the second (Table 5.10). Part of this might probably be considered as waste from operating rooms. Laboratories, OB/GYN and ICU rooms were also frequently cited.

*For the private hospitals:*

According to the survey operating rooms OR was most frequently listed as the largest source of medical waste while OB\GYN was cited the second, see Table 5.11.

Hospital Name	First wards	Second wards	Third wards	Fourth wards	Fifth Wards
Sultan	Lab	dialysis	ICU	ER	OR
National	Ob-Gyn	ER	OR	ICU	Lab
Hamady	OR	Lab	ER	ICU	Lab
Moasah	OR	Ob-Gyn	ICU	Lab	ER
Meshary	OR	Ob-Gyn	Lab	ER	ICU
Obeed	OR	Ob-Gyn	ER	Lab	ICU
COSE	ER	OR	Ob-Gyn	ICU	Lab
Green-cr	OR	Ob-Gyn	ICU	Lab	ER
Mubarak	OR	Ob-Gyn	ICU	Lab	ER
German	ER	OR	Ob-Gyn	ICU	Lab
Kingdom	OR	Ob-Gyn	ER	Lab	ICU
Falah	OR	Ob-Gyn	ER	ICU	NICU
Dallah	OR	Ob-Gyn	CCU	ICU	Paediatric
Habieb	Ob-Gyn	OR	Lab	ICU	ER

Table 5.11: Wards that generate the medical waste in private hospitals

### 5.3.4 Waste Segregation

Part of the questionnaire was aimed to investigate whether or not the facility practices waste segregation. In addition, the following were investigated in questionnaire B (more details about how data were collected have been explained in section 4.1.1 and section 4.2). If the colour coding system was used in managing waste in the facilities, the type of containers used in the collection of waste in the health facilities and if those containers were readily available all the time for use.

The following are the results from the answers to the section in the survey requesting information on segregation, treatment and cost of disposal of the wastes.

The following are the results on segregation and are based on all the hospitals responding to the survey. (29 of 30) 97.6% of the respondents said that they segregated their waste. 90.2% (27 of 30) of the respondents said that they segregated Type D waste. 75.6% (21 of 30) segregated Type B, 73.2% (20 of 30) segregated Type A, 70.1% (19 of 30) segregated Type C and Type H, 61% segregated Type F, 53.6% segregated Type G and 46.3% (14 of 30) segregated Type E.

The survey revealed that almost all (97.6%) of the hospitals surveyed practiced some sort of medical waste segregation. Table 5.12 shows the type of medical waste segregated and the percentage of segregating hospitals.

Waste category segregated	% of segregating hospitals
Type D	90.2
Type B	75.6
Type A	73.2
Type C	70.1
Type H	70.1
Type F	61
Type G	53.6
Type E	46.3

Table 5.12: segregation of medical waste

It was noticed that the hospitals that have been visited did not segregate all medical waste categories from one another. However, sharps and cultures were segregated from other medical waste prior to treatment and disposal. In all visited hospitals both red bags and general trash bags were present in all rooms in addition to a sharp container mounted on the wall of the rooms.

Also the following were investigated: if the colour coding system were used in managing waste in the facilities, the type of containers used in collection of waste in the health facilities and if those containers were readily available all the time for use. Also the average filling capacity of the bins and the number of containers present for waste collection per section were investigated. Investigations were also made to know if there is any special equipment for sharp waste handling in health facilities.

From all respondent hospitals all waste separated by the medical staff into three categories:

1. General healthcare waste usually put into black bags
2. Potentially infectious healthcare waste (also known as hazardous healthcare waste).  
Usually put into yellow bags
3. Used sharps put into rigid yellow containers

In all cases waste are collected daily (or as frequently as required) and transported to the designated central storage site. Measures of this sort helped to minimise the costs of healthcare waste collection and treatment in many Saudi hospitals.

General waste such as garbage and garden refuse join the stream of domestic refuse. Sharps are collected in puncture proof containers. Bags and containers for infectious waste marked with Biohazard symbol. Cytotoxic wastes are to be collected in leak proof containers clearly labelled as cytotoxic waste. In some hospitals, needles and syringes destroyed with the help of needle destroyer and syringe cutters provided at the point of generation. Infusion sets, bottles and gloves should be cut with curved scissors.

Disinfection of sharps soiled linen, plastic and rubber goods are to be achieved at point of generation by usage of sodium hypochlorite with minimum contact of one hour. On site collection requires staff to close the waste bags when they are three quarters full either by tying the neck or by sealing the bag ( some hospitals which they have American and British workers ).

Sharp containers were on medical carts too in one of the facility visited. The facilities visited used single use, throw away sharps container. These containers added to the amount of waste generated. Suction fluids were commonly discharged into the sewer system in at least one of the hospitals visited. According to them, it was a common practice in all hospitals.

Human body parts present both a sanitation and public health risk. For these reasons, body parts must be disposed of properly. In this study, the term ‘disposal of body parts’ is the practice and process of dealing with the remains of a deceased human being. In general, several methods for disposal of human parts are practiced. In many cases, the manner of disposal is dominated by spiritual concerns and a desire to show respect for the dead, and may be highly ritualized. This event may be part of a larger funeral ritual. Many religions as well as legal jurisdictions have set rules regarding the disposal of body parts. Since the experience of death is universal to all



humans, practices regarding body parts disposal are a part of nearly every culture. Different religions and cultures have various funeral rites that accompany the disposal of a body. When it is not possible for a body to be disposed of promptly, it is generally stored at a morgue.

The body parts are a pathological waste this type of risk waste consists of fragments of tissues and organs, non-viable foetuses, placenta, all of these waste from human body parts are required to be handled separately in accordance to Islamic fatwa No.8099 dated 21 safer 1405 H. Accordingly, body parts are separated in black bags and stored in the morgue that will be collected by the council of Riyadh city to be buried on the cemetery once every two weeks.

### **5.3.5 Handling**

From all responded hospitals, we found we found in 58% of hospitals, the wastes were collected at 8:00 Am., and 4:00pm. At the end of each shift, hospital wastes were transported to a temporary storage area by hospital staff. In 17% of hospitals, medical wastes were collected daily and in 25%, the collection program was unsteadily. In 46% of hospitals these wastes were collected by trolley in 46% manually and in 8% both systems were applied. The staff employed for handling the wastes in all hospitals used almost complete personal protective equipment (the protective equipment included special dress, shirt and trousers along with at least two of the following: gloves, mask, boots, and apron).

### **5.3.6 Waste storage**

This part of waste management investigated on the presence of a temporary storage premise large enough to handle the waste generated in hospitals. Also investigations were made to know if the facilities temporarily store waste before treatment and disposal, and if the waste is stored, for how long the facility stores that waste before further actions. The standard time for storing medical wastes recommended by the World Health Organization should not exceed 24 hr. Also investigations were made to know if the waste handler weigh and keep records for the waste generated. This part also investigated the presence of any hand washing facility and a written Standard Operating Procedure (SOP) for waste management in the facilities. So the time from the responses was compared to this standard time. Storage areas should be fenced, big enough and well ventilated and should be accessible by the authorized personnel only.

In all studied hospitals, there were temporary storage sites. The distance between these sites to the nearest department was about 10-100m. These sites included metal containers (10%), concrete rooms (10%), special rooms (70%), used barrels (5%) and open enclosure sites (5%) (Taher, Hajjar 2014). The infectious and non-infectious wastes were kept in separate containers and were not mixed in the hospital's temporary storage area. Only 20% of hospitals had a well sanitized and secured temporary storage area and the others (80%) had well secured but poorly sanitized temporary storage areas. The storage time in those sites were 12- 24hr (75%) and 24-48hr (25%) (Agunwamba, Emenike & Tenebe 2013). Side storage area needs to be impermeable and hard standing with good drainage. It should provide an easy access to waste collection vehicle.

Medical waste is transported within the hospital by means of wheeled trolleys, containers or carts that are not used for any other purpose. The trolleys are cleaned daily. Well-designed vehicle with suitable criteria is used for external transportation. This vehicle is definitely different from solid waste vehicle. Off-site transportation vehicles are marked with the name and address of carrier. Biohazard symbol is painted on the vehicle.

The inner space of the vehicle is layered by stainless steel and aluminium to give smooth surface for cleaning purposes. Every hole and pores inside it must be closed to prevent the waste from sticking and left behind when unloading and cleaning process. The vehicle cannot be used for other purposes. It is always provided with all equipment for cleaning and personal protective equipment to clean storage after several processes of loading and unloading the waste.

### **5.3.7 Treatment and Disposal of Healthcare Waste**

Part of the questioner was aimed to investigate the treatment methods and the onsite treatment facility at the targeted hospitals. In addition the presence of any specifically designated area for health care waste disposal was investigated too. The disposal method used in health facilities and means of healthcare waste transportation were also investigated in questionnaire A. Investigations were also made to know if the facilities incinerate wastes, the size of the incinerator present in the health facility if existed, and if the incinerators were in good operating conditions.

The survey asked the hospitals about the method they used for treatment and disposal of medical waste. The following are the results from the answers to the section in the survey requesting information on treatment and cost of disposal of the wastes.

All the hospitals and health care centres in Riyadh city are not allowed by law to carry out onsite medical waste treatment, this is to safeguard against pollution (Shereif and Al-Shallash.2007). Consequently, there are no onsite incinerators, all types of medical waste treatment are conducted off site by contractors. The final disposal of the healthcare waste is implemented through different private companies using different types of waste disposal. One of these companies is using a microwave irradiation process at their facilities in Riyadh. The other two companies in Riyadh city use incinerators with emission controls that are compliant with the PME regulations.

The latest guidelines issued in February 2001 by the Saudi government stipulated that all on-site treatment plants have to shut down and sub-contract the process to specialised companies that are licensed by PME. Currently, seven companies that offer medical waste handling and treatment in various parts of Saudi Arabia. More companies are expected to get a license from PME in the near future (Shereif and Al-Shallash.2007).

Unified code for the management and disposal of medical waste was established in 1999, adopted in 2005. The regulations impose restrictions on the generation, transport, handling, storage, treatment, disposal of healthcare waste. The regulations recommended the following:

- The private sector will be encouraged to invest and assume a vital and increasing role in the safe treatment and disposal of infectious waste. All existing incinerators at various on-site medical facilities in the GCC should be decommissioned by 2004.
- Both the government and private sector have to provide training and conduct workshops and seminars to educate healthcare staff on the proper and safe handling, packaging, transporting, and disposal of infectious waste. In addition, the government of Saudi Arabia was one of the parties that signed the “Basel convention,1989” coordinated by united nation environment program (UNEP) this convention concerns trans boundary movement of hazards waste and is also applicable to hazardous healthcare waste

- The Government has formulated the Bio-Medical Waste (Handling and Management) Rules in 1998 (hereafter referred to as the Bio-Medical Waste Rules) in order to specify procedures that have to be followed in the management and disposal of waste. The rules regulate the disposal of bio-medical waste including human anatomical waste, blood, body fluids, medicines, glassware, soiled, liquid & biotechnology waste and animal waste.

The rules have been formulated as framework for handling & management of biomedical wastes. The rules are applicable to all hospitals, nursing homes and health related places in the country and also apply to all persons who generate, collect, receive, store, transport, treat, dispose or handle biomedical waste in any form

### **5.3.8 Medical waste Treatment Technologies Used by Companies**

The medical waste treatment technologies which are used on all respondent hospitals in Riyadh city can be summarised as the following:

#### **Autoclave**

The SEPCO Company implemented their design, which is locally manufactured autoclave called, SEPCO Clave. In the autoclave the infectious waste is sterilized with steam. For effective and efficient sterilization the degree of steam penetration is the most importance factor. SEPCO Clave high vacuum and high pressure systems ensure thorough and uniform penetration of steam into the biological waste to be treated. Thus, the waste is completely sterilized in autoclaves. Afterwards, the waste is shredded into unrecognizable reduced size.

#### **Thermal Oxidation Unit**

All pharmaceutical products, drugs, drug residuals and therapeutic chemicals that have been returned from wards or have been spilled, out-dated, contaminated, or are to be discharged because they are no longer required are subjected to thermal oxidation. Any substance, liquid or solid which is toxic, corrosive, carcinogenic, mutagenious or genotoxic (Cytotoxics) waste can be treated by the thermal oxidation units fitted with air emission control system to comply with international environmental standard. From the respondent hospitals there are two companies which they have all the contracts with the health care centres and hospitals SEPCO and KAID company

## **SEPCO**

Saudi Gulf Environmental Protection Company (SEPCO) Environment was established in 1997 as a unique company in the field of Environmental Protection. The company specialised initially in biological Waste Management which presently SEPCO Environment is the Gulf area leader in this field. The company provides biological waste disposal services to more than 4884 health care facilities (such as hospitals, polyclinics, research centres, etc.) in the Kingdom of Saudi Arabia. SEPCO Environment service includes environmental consulting and studies medical and pharmaceutical waste management training, transportation and treatment. SEPCO Environment acts as an agent and distributor for companies and industries in environmental monitoring, pollution control systems and waste treatment systems.

SEPCO Environment owns a fleet of trucks specially equipped for transporting biological waste from the assembling points to the treatment stations, according to the conditions set by the PME which is mentioned before, in addition to the ministries of health and Transportation.

## **Kaid Company**

It is the second contractor and they started with the industries regions to treat the municipal waste especially in the eastern and western regions of the kingdom of Saudi Arabia. The company has a centre for environmental study specialised in the medical waste management. In Riyadh region they have contractors with the health care facilities to treat the medical waste with thermal oxidation procedure.

## **5.4 Cost of disposal of medical waste**

Regarding the cost of disposal of medical waste, all of the respondents had provided the following financial information through the interviews and questionnaire questions that they use off-site commercial facilities to treat at least most of their waste. In Riyadh city, the average total cost of disposal in terms of cost/hospital/month was 3090SR for a government hospital. While the average total cost of disposal in terms of cost/hospital/month was 2000SR for a private hospital according to the survey's results. All respondents had given the cost of treatment and transportation of waste. For the government hospitals information summarised in Table 5.13 and for the private hospitals presented in Table 5.14.

<b>Name of hospital</b>	<b>Costs in SR (Per month)</b>
Amal	20000
KSH	30000
KAUH	50000
KFMC	47200
Yamamah	4000
Military	50000
Eman	30000
Force	50000
King Saud	50000
Salman	30000
KUH	30000
N-Guared	100000
KKEH	15000
Military2	50000
KFSH	100000
<b>Total</b>	<b>556200</b>

Table 5.13: cost of medical waste treatment per year in government hospital (1 SR = 3.75 USD)

<b>Name of hospital</b>	<b>Costs in SR (Per month)</b>
Saultan	50000
National	15000
Hamady	30000
Moasah	20000
Meshary	50000
Obaed	20000
COSE	7000
Green-cr	10000
Mubark	15000
German	50000
Kingdam	10000
Falah	6000
Dallah	10000
Habieb	3000
Eligent	10000
<b>Total</b>	<b>306000</b>

Table 5.14: cost of medical waste treatment per year in private hospitals (1 SR = 3.75 USD)

## **5.5 Summary of Chapter**

In this chapter, a discussion regarding the status of healthcare waste generation and its management facilities for Riyadh city has been presented. The data for this chapter was collected by the survey questionnaire; site visits and in person meetings with staff. The findings from the collected information are presented in form of summarised tables and graphical illustrations. The next chapter is dealing with the survey findings in more in-depth.



# Chapter 6: Medical Staff Preparedness and Attitude towards Medical Waste Management

---

This chapter presents the findings from the study, which has been conducted with the objective to assess Saudi hospitals Medical Staff Readiness and Attitude towards Medical Waste Management. The findings are believed to be useful to the establishment of a national framework for tackling issues with waste management in Saudi Arabia.

## **6.1 Sample**

In this study a sample of 80 medical staff from five hospitals participated in the study, as shown in Table 6.1. Including group of 20 from four medical profession; Doctors, Nurses, Pharmacists and lab Technicians; working in seven different departments Table 6.2. The sample size covers several hospitals, specialisations, tasks, educational levels, cultures, experiences and training levels. The study has focused on the diversity inside the sample rather than the size of the sample itself, in order to validate the point of views from several parts and sections. Four of the largest hospitals that distributed in several areas in Riyadh were taken into considerations as in table 6.1.

The survey was administered by personal visits, mails, and emails, where the researchers sent the questionnaire to those who were in charge and assured that there would be a high response rate from them. Some of the respondents were unclear regarding some of a questions and a clarification used to be sent again. Ethical explanations have been delivered to the respondents and their approvals have been gained before starting the surveys.

Several research students have been chosen to help in this survey around the medical hospitals It is vital to make sure that the respondents get an efficient clarification for the process and the questions of the survey. Hence, this helped in raising the efficiency and accuracy of the responded results.

Hospital	Frequency	Percent
KKUH	16	20%
AL-EMAN	16	20%
DALLAH	16	20%
MILITARY	16	20%
KFSH	16	20%
Total	80	100%

Table 6.1: Participated Hospitals

Department	Frequency	Percent
Emergency	12	15%
ICU	7	8.8%
Ob\gyn	10	12.5%
Outpatient	8	10.0%
Surgery	2	2.5%
Pharmacy	20	25%
Laboratory	21	26.3%
<b>Total</b>	<b>80</b>	<b>100%</b>

Table 6.2: Participated Hospitals Departments

The data were collected from different sections and specializations in the hospitals to support the principle of diversity in analyzing the effects, and reasons, which will assess in establishing an accurate national framework that depends on an investigation that includes the studying the behavior of staff depending on their tasks and functions. This is believed to be an important factor in dealing with the problem and preparing the solution in a suitable framework that deals with each specialism in the hospitals according to their tasks and nature of work.

In table 6.2, most of the roles in hospitals have been included depending on the different specializations and tasks that deal with medical wastes, where it is believed that every specialization has its own criteria and behavior in dealing with the medical wastes.

## 6.2 Data Analysis and Findings

As can be seen from Table 6.3; the vast majority of the participants hold bachelor degree or above, the other participants hold lower qualifications; diploma.

Qualification	Frequency	Percent
Bachelor	40	50%
Bachelor + Diploma	17	21.3%
Diploma	11	13.8%
Bachelor + Board	5	6.3%
Bachelor + American Board	7	8.8%
<b>Total</b>	<b>80</b>	<b>100%</b>

Table 6.3: Participates Qualifications

The level of gained studies is taken into consideration as factor that is believed to be effective in determining the level of understanding, readiness, awareness and attitude towards Medical Waste Management. This kind of diversity in the study investigates the attitude of the staff regarding the medical waste treatment from an educational side as the previous table is covering the study from the occupational side. This is another part that would be taken as a factor in designing a national framework for the Medical Waste Management, in order to cover most of the study side depending on several factors such as education, factions, tasks and cultures.

It can be seen that medical staff in Saudi hospitals graduated from different countries; where the majority is from Saudi followed by Philippine, Egypt, India, UK, Jordan, Palestine, Pakistan, USA, and South Africa. This side of study investigated the situation of Medical Waste Management from a cultural background, where the culture is considered an important factor in analysing the state of medical waste awareness and attitude towards it. In this study, several culture and international background have been taken into consideration in dealing with medical

waste, where the study depends on covering most of the factors that could be effective in designing a suitable framework that deals with each side for the problem.

<b>Country of Graduation</b>	<b>Frequency</b>	<b>Percent</b>
Egypt	11	13.9%
India	8	10%
Jordan	6	7.6%
Pakistan	3	3.8%
Philippines	13	16.3%
Palestine	5	5%
Saudi	24	30%
South Africa	1	1.3%
UK	7	8.8%
USA	2	2.5%
Total	80	100.0

Table 6.4: Participates Country of Graduation

As experience and training courses are considered important factor in affecting the analysis of the study, this factor is investigated by taking several employees from several graduation years to support the principle of diversity in experience and training. Table 6.5 shows that the vast majority of the participants graduated between year 2001 and 2010, this indicates that they are relatively experienced staff and attended modernised higher education programmes.

<b>Year of Graduation</b>	<b>Frequency</b>	<b>Present</b>
1990	1	1.3%
1993	1	1.3%
1996	2	2.5%
1997	1	1.3%
1998	5	6.3%
1999	1	1.3%
2000	9	11.3%
2001	5	6.3%
2002	1	1.3%
2003	5	6.3%
2004	3	3.8%
2005	7	8.8%
2006	3	3.8%
2007	5	6.3%
2008	6	7.5%
2009	10	12.5%
2010	15	18.8%
<b>Total</b>	<b>80</b>	<b>100%</b>

Table 6.5: Year of Graduation

The outcome from Table 6.6 regarding the degree of concern in relation to medical waste came in support with the main aim of this research work, since 47.5% of the participates did show slight concern.

Degree of concern	Frequency	Percent
Highly concerned	42	52.5%
Slightly concerned	38	47.5%
Total	80	100%

Table 6.6: Medical staff Degree of Concern in relation with Medical Waste

Question	Total Mean	Std. Deviation	Yes/No
Q1: Have you studied any waste management subject in your graduation/ university level?	1.14	0.347	yes
Q2: Have you attend any training on waste management?	1.05	0.219	yes
Q3: Do you think some staff might put waste in wrong bin?	1.05	0.219	yes
Q4: Does your department offers any training to all staff on waste management?	1.11	0.318	yes
Q5: Does your department offer waste bins color coding system?	1.05	0.219	yes
Q6: Do you think your department does enough awareness campaigns related to medical waste management?	1.51	0.503	No
Q7: Does your department have apply any monitoring or control system related to waste management?	1.40	0.493	yes
Q8: Does your department take any against Mismanagement of mishandling of medical waste?	2.00	0.000	No
Q9: Does your department employee specialised staff responsible for medical waste management?	1.14	0.347	yes
Q10: Are you aware of any national framework or policy related to medical waste management in Saudi?	1.54	0.502	No
Q11: Do you think there is a gap between Saudi and developing countries in how waste management treated?	1.18	0.382	yes
Q12: Do you think there is need for more investment on factories for recycling of medical waste?	1.41	0.495	yes

Table 6.7: Descriptive Analysis

Response came very positive, as all participants seem to have studied modules related to medical waste during their university programme. Moreover, they also seem to have attended training in their job. Also they confirm that training is available by their departments. Further good indicators, coloured waste bins are offered to segregate waste. Other Response came with some disappointment as it indicates some mishandling of medical waste by some of medical staff. Regarding awareness campaigns by departments about medical waste, response came negative, as it seems staffs are not well informed by their departments. Moreover, disagreement emerged between participants regarding the existence of monitoring and control of waste management by each department. That coupled with more unexpected response, which presented absence of actions taken against staff mishandling medical waste. Adding to that the absence of specialised staff on medical waste management, lack of knowledge of any national framework or policy related to waste management, the feeling of gap existence when compared with developed countries, and the need for more investments in recycling medical waste. Therefore, this does highlight the main problems related to the current situation with medical waste management in Saudi, which enforce the motivation of this research work for the need to establish a new framework to govern medical waste treatment in Saudi Arabia. However, in order to support the credibility of the descriptive analysis further test; the one-way ANOVA test has been performed.

<b>Between Groups In each Question</b>		<b>Sum of Squares</b>	<b>df</b>	<b>Mean Square</b>	<b>F</b>	<b>Sig.</b>
<b>Q1</b>	Between Groups	0.338	3	0.113	0.934	0.428
	Total	9.488	79			
<b>Q2</b>	Between Groups	0.200	3	0.067	1.407	0.247
	Total	3.800	79			
<b>Q3</b>	Between Groups	0.600	3	0.200	4.750	0.004
	Total	3.800	79			

Q4	Between Groups	0.638	3	0.213	2.197	0.095
	Total	7.988	79			
Q5	Between Groups	0.600	3	0.200	4.750	0.004
	Total	3.800	79			
Q6	Between Groups	0.138	3	0.046	0.175	0.913
	Total	19.988	79			
Q7	Between Groups	0.500	3	0.167	.677	0.569
	Total	19.200	79			
Q8	Between Groups	0.000	3	0.000	.	.
	Total	0.000	79			
Q9	Between Groups	4.538	3	1.513	23.222	0.000
	Total	9.488	79			
Q10	Between Groups	0.438	3	0.146	.570	0.637
	Total	19.888	79			
Q11	Between Groups	0.250	3	0.083	.560	0.643
	Total	11.550	79			
Q12	Between Groups	1.138	3	0.379	1.579	0.201
	Total	19.388	79			

Table 6.8: Significance of Variance between participated Groups

The ANOVA analysis, the one-way ANOVA test analysis enabled finding the differences between the groups point of views. Results came in line with the descriptive findings, it even added indication of two new problems as shown from Q5 and Q6. This means that there is debate if the department offers waste bins with coding system or not. In addition, debate on the availability of specialise staff responsible for medical waste management. Moreover, the finding from ANOVA analysis showed there is a different point of views on point represented by Q3; regarding the possibility of waste mishandling or putting waste in the wrong bin. As the ANOVA table shows the differences between participants groups if the value of Sig. column is less than or equal than 0.05. Nevertheless, this did not tell which groups are disagreeing with each other. Therefore, the Tukey HSD (honestly significant difference) analysis, which is known as multiple



comparison tests, can show that. Although the findings from both ANOVA and deceptive analysis are sufficient to present the challenges, Tukey test has been performed as an additional enforcement for the results.

<b>Dependent Variable</b>	<b>(I) GROUPS</b>	<b>(J) GROUPS</b>	<b>Sig.</b>
<b>Q3</b>	Nurse	Doctor	0.015
		Pharmacist	0.015
		Lab Tech	0.015
<b>Q5</b>	Pharmacist	Nurse	0.015
		Doctor	0.015
		Lab Tech	0.015
<b>Q9</b>	Pharmacist	Nurse	0.000
		Doctor	0.000
		Lab Tech	0.000

Table 6.9: Summary for Multiple Comparisons Test

The Multiple comparison table 6.9 shows significant difference across the groups with specific items. The significant differences are listed in the summary table and for value lower than 0.05 in sig. column. It is clear that for Q3 Nurse group is significantly different from other groups, while for Q5 and Q9 Pharmacist group is significantly different from other groups.

### 6.3 Summary of Chapter

This study was very useful to evaluate Medical Staff Readiness and Attitude towards Medical Waste Management. The findings from the study did identify a number of issues to be taken in consideration to establish a national framework to govern medical waste handling and treatment. The findings from this chapter will be used in the next chapter to propose the framework.

# Chapter 7: Framework for the Medical Waste Management in Riyadh city

---

This chapter presents the last task of research work, which has been conducted to propose a strategic framework. Two key success factors have been taken into consideration to build this framework. They are directly related to Saudi Arabia system and based on the early outcomes, can be summarised as followed:

## **7.1 The Inclusion of Islamic Principals**

Since Saudi Arabia is as Islamic state and most of the laws and policies are based on Islamic principles, and to avoid any failure due to what is seen to be importing any foreign approach, the proposed framework has to be in compliance with Islamic law. Moreover, to enable the maximum benefit from mosques and Friday speech to propagate awareness campaigns on medical waste effects to both medical staff and citizens. One element of the proposed framework was suggested to include the Islamic values, which support caring for, ourselves, people and environment, also it encourage the best practices when doing our job and the necessity of waste handling.

## **7.2 Addressing Major Issues from Pervious tasks**

It was important for the proposed framework to serve as a platform which can enable overcoming the main challenges emerged from the early conducted research tasks. Thus the findings have been translated into key requirements for constructing the framework, as explained on the methodology part Figure 4.4; key requirements are listed, as follows:

- There is no uniform practice for treating medical waste in Riyadh city hospitals.
- Some initiatives might have been taken but not fully implemented.
- The level of treatment in medical waste is different in city hospitals.

- There is no clear evidence on the efficiency of medical waste management monitoring and control system.
- There is a technological gap between Saudi Arabia and developed countries in medical waste management
- There is a lake of investment in medical waste.

### 7.3 The Framework

To provide easy understanding for the framework, graphical representation has been illustrated as shown in Figure 7.1., while Figure 7.2 explain the role of each part.



Figure 7.1 The Proposed Strategy Framework

**R1: Uniform practices for treating medical waste**

- Universities should review and include a compulsory subject in health care graduate programmes
- Making waste management as a essential part of staff development

**R2: Initiatives are taken but not implemented practically**

- Linking initiatives with religion and key facts of health implication in waste management through community involvement

**R3:1. level of treatment in medical waste is different**

- Implementing national policy and integrity of legal framework ie treating as offence and mishandling at institutional and staff level.

**R4: Efficient medical waste management monitoring and control system**

- Enforcement of independent monitoring and controlling agency with specialized and trained staff

**R5: Technological gap between Saudi Arabia and developed countries**

- Involvement of research institutes to identify and recommended the state of art technologies

**R6: Investment in medical waste management**

- Involving and inform the investors about the opportunities in medical waste management industry

Figure 7.2 Addressing the Key Requirements

The findings of the, hospitals survey and corresponding waste management, survey analysis and research of attitude towards medical waste management; have been translated into key requirements for constructing the framework, hence these requirements have been met by a strategy that is showed in figure 7.2, where each table in figure 7.2 illustrates a proposed solution and a strategy for each finding from the early conducted research tasks to serve as a platform which can enable overcoming the main challenges and to get an answer for the main research questions.

## 7.4 Framework Evaluation

In order to evaluate the proposed framework, consortium of assessors from the same sample as the last study, which includes; 80 Medical staff from five hospitals, as shown in Table 7.1, were divided into four group of 20 from four medical profession; Doctors, Nurses, Pharmacists and lab Technicians.

Question	Total Mean	Std. Deviation	Remarks
Q1: There is a need of a special course/module in healthcare subject about medical waste management at graduation/university level?	1.39	0.490	Agree
Q2: Staff members should have specific training on medical waste management.	1.56	0.524	Agree
Q3: I believe it will be effective if mosques/imams help to promote health risks related to medical waste for community awareness part of Friday prayer ( Kwtabah) ?	1.49	0.994	Agree
Q4: There is a need of implementing uniform national policies for the medical waste management in hospitals in Saudi Arabia?	2.26	0.631	Agree
Q5: I believe Mismanagement and mishandling of medical waste should be taken legally.	1.81	0.553	Agree
Q6: There Is a need for separate independent monitoring and controlling authority for medical waste management in Saudi Arabia?	2.51	0.795	Natural
Q7: Some members of Staff should be specialized and trained in	2.83	0.839	Natural

handling and treatment methods of medical waste.			
Q8: Medical research centers and academic institutions must be involve identifying and recommends the state of art technologies for waste management.	2.01	0.665	Agree
Q9: Government should encourage investors to invest in medical waste management recycling business.	2.43	0.808	Agree
<b>Average</b>	<b>2.032</b>		<b>Agree</b>

Table 7.1: Descriptive Analysis

## 7.5 Data Analysis and Findings

As it can be seen from the descriptive analysis, there is an agreement on 7 points out of 9 elements on the proposed framework, with mean between 1.39 and 2.01. The evaluators did not disagree with the other 2 points but they are still neutral about them, with mean of 2.51 and 2.83

Between Groups In each Question		Sum of Squares	df	Mean Square	F	Sig.
Q1	Between Groups	.838	3	.279	1.169	.327
	Total	18.988	79			
Q2	Between Groups	5.738	3	1.913	9.113	.000
	Total	21.688	79			
Q3	Between Groups	2.238	3	.746	.748	.527
	Total	77.988	79			
Q4	Between Groups	1.438	3	.479	1.212	.311
	Total	31.488	79			
Q5	Between Groups	4.838	3	1.613	6.333	.001
	Total	24.188	79			
Q6	Between Groups	.438	3	.146	.224	.880
	Total	49.988	79			
Q7	Between Groups	1.050	3	.350	.488	.692
	Total	55.550	79			

<b>Q8</b>	Between Groups	2.438	3	.813	1.897	.137
	Total	34.988	79			
<b>Q9</b>	Between Groups	3.450	3	1.150	1.817	.151
	Total	51.550	79			

Table 7.2: Significance of Variance between participated groups

Moreover, the calculated total mean average came as 2.032, which means the general perception towards having the framework is good. Never the less, to obtain more support for this finding from the descriptive analysis, further test; the one-way ANOVA test has been executed. The one-way ANOVA analysis shows that in 7 out of 9 of the component in the framework are in agreement with no significant difference on their point of views. This supports the finding from the descriptive analysis for the two elements in Q2 and Q5 the ANOVA analysis shows significant difference between the different groups. Therefore, the third analysis, Multiple Comparisons Test (Tukey HSD) has been conducted to identify the groups causing the difference; summary of the test findings is presented in Table 7.3.

<b>Dependent Variable</b>	<b>(I) GROUPS</b>	<b>(J) GROUPS</b>	<b>Sig.</b>
<b>Q2</b>	Pharmacist	Nurse	0.001
		Doctor	0.014
		Lab Tech	0.000
<b>Q5</b>	Pharmacist	Nurse	0.002
		Lab Tech	0.002

Table 7.3: Summary for Multiple Comparisons Test

As it can be seen from Table 7.3, the pharmacist group is significantly different from the other three groups' nurses, doctors and lab technicians in Q2. In addition, the pharmacist group is significantly different with their votes from nurses and lab technicians in Q5. Since the other mean groups are contestant with their votes and the total vote for Q2 and Q5 came on favourer of these two elements in the framework. In addition to the fact, some medical staff might see that as an extra hurdle. At this stage, this can be classified, as organisational resistance towards the new changes.

The survey were designed and administered according to the following methodology:

- Identification for the required sample number that could achieve a high level of accuracy
- Contacting the responsible people to get acceptance and confirmation
- Design and evaluating the surveys questions
- Designing a strategy for distributing the surveys, explaining them, and collecting them back
- Distributing the survey by mail, emails, and individual visits
- Collecting and analysing the results.

## **7.6 Summary of Chapter**

In this chapter a framework has been proposed and evaluated by four groups from several medical departments. Based on the evaluation outcomes, it can be concluded; that the proposed framework is capable of improving medical waste management in the Kingdom of Saudi Arabia. All of the evaluators have shown positive attitude towards the proposed framework. They believe that the framework will serve as a main contributor that will lead to the betterment of medical waste handling and treatment as well as resolving the challenges highlighted in the early chapters.



# Chapter 8: Conclusions, limitations and Recommendations for further work

---

## 8.1 Conclusions

This research work has been conducted with the aim to investigate the status of medical waste management in the capital of Saudi Arabia; Riyadh city. From the critical review and analysis of the relevant literature, it can be seen that there was a lack of scientific studies of medical and biological waste management in Saudi Arabia and in the Gulf region. Hence, this research work is aimed to filling the gap in literature and will act as prelude for future work to be conducted. In addition, this research work has been extended to propose a strategic framework to be used as roadmap for different stakeholders for better medical waste management and treatment in Saudi Arabia in particular and other countries with similar environment in general.

Based on the findings from each task accomplished within this research project, several conclusions can be made. First, the survey of the different waste treatment technologies revealed different options that can be utilized in Saudi Arabia to enable a better and more efficient medical waste treatment than the current systems. However, there was no clear evidence to indicate that enough effort has been made on identifying and transferring state-of-the-art innovation to Saudi hospitals, although cost is not the main barrier over there. Secondly, looking into the findings from hospitals survey research task, and the gathered information of the different aspects of medical waste management, it can be clearly seen that the amount of generated waste is likely to increase with the current booming of the city.

On the other hand, if the current methods and systems of medical waste management remained without improvement, coupled with the lack of clear vision for future

challenges, it might lead to major environmental issues. This means, more efforts and investment need be made on planning and implementing medical waste management projects.

Thirdly, to add to the early mentioned points, the findings from interviews conducted to evaluate healthcare staff readiness and attitude towards medical waste management, revealed very important and serious points, which need to be tackled. Some of these points are: mishandling of medical waste, lack of monitoring, lack of enforcements, lack of awareness of national framework, and deviation between medical staff concern towards medical waste management. Regarding medical waste generation, the research revealed that OR section has the most waste generation, which requires more attention in terms of medical waste management and staff training.

The findings for all the tasks have been utilized to construct and propose a framework, with the inclusion of very essential point (linking waste management to Islamic principles), since, Saudi Arabia is govern by Islamic system. Such initiative should be more successful, rather than just importing like any other frameworks made for different environmental issues. The evaluation of the proposed framework by different medical staff was positive and came in favour of the framework with no disagreement on any point in the structure of the framework; only two points are still to be confirmed once the framework has been deployed in reality.

Furthermore, the proposed framework has addressed shortcomings in proper management of medical waste management, and is intended improve medical waste management, in the Kingdom of Saudi Arabia. All of the evaluators have shown positive attitude towards the proposed framework. The framework was intended to serve as a main contributor that will lead to the betterment of medical waste handling and treatment as well as resolving the challenges highlighted in the research.

## **8.2 Limitations**

Like any other research project, this research work has its limitations; the finding from each task was subject to time restraint given the time framework to complete the PhD. In addition, this kind of project is subject to the availability of reliable information and the support of the medical staff. Some of the findings might be seen subjective; however, they still serve to picture the whole situation and were sufficient for the main goal of this research project. The evaluation of the proposed framework can be considered as initial and yet sufficient at this stage, more thorough evaluation and alignment need to be conducted. Furthermore, some tasks might need to be taken further; this will be suggested as a further research.

## **8.3 Recommendations for Further Work**

In addition to the findings and the contributions to knowledge made by this research project, further achievements can be made if the following points are to be considered for further research work:

- Since the research project was focused on the capital city, same research tasks can be extended to other cities, so that a complete picture for Saudi is formed in order to draw more comparisons and support of the current findings.
- Since the proposed framework was evaluated by medical staff only, further evaluation need to be conducted on the effectiveness of the framework in real life and, if required, further alignment and tuning is carried out.
- Some research work is needed on establishing or reviewing the laws and policies for medical waste management as it was outside the scope of this project. This has been identified within the main shortcomings.
- Further research can be carried out so as to establish a business model for future investment on recycling of medical waste, and to attract investors to join this industry. This can be combined with other models for technology transfer for medical waste treatment technologies.
- Finally, the research work can expanded to explore the possibility of using this framework for other countries in the region and globally.

## References

- Agunwamba, J., Emenike, P. & Tenebe, I. 2013, "COMPARATIVE ANALYSIS OF HOSPITAL WASTE MANAGEMENT IN CALABAR METROPOLIS AND DEVELOPED COUNTRIES", .
- Ahmed, S., Soni, S. & Gupta, A. 2013, "" BIO MEDICAL WASTE-A SIGNIFICANT ISSUE".", *Guident*, vol. 6, no. 3.
- Al-Ansary, L.A. & Khoja, T.A. 2002, "The place of evidence-based medicine among primary health care physicians in Riyadh region, Saudi Arabia", *Family practice*, vol. 19, no. 5, pp. 537-542.
- Al-Falih, K.A. 2010, "Saudi Aramco and Its Role in Saudi Arabia's Present and Future", *Brazil Oil & Gas, tt\_nrg and Norway Oil & Gas*, , pp. 14.
- Almalki, M., Fitzgerald, G. & Clark, M. 2011, "Health care system in Saudi Arabia: an overview", *EMHJ*, vol. 17, no. 10.
- Almuneef, M. & Memish, Z.A. 2003, "Effective medical waste management: it can be done", *American Journal of Infection Control*, vol. 31, no. 3, pp. 188-192.
- Anastasiadou, K., Christopoulos, K., Mousios, E. & Gidaracos, E. 2012, "Solidification/stabilization of fly and bottom ash from medical waste incineration facility", *Journal of hazardous materials*, vol. 207, pp. 165-170.
- Assamoi, B. & Lawryshyn, Y. 2012, "The environmental comparison of landfilling vs. incineration of MSW accounting for waste diversion", *Waste Management*, vol. 32, no. 5, pp. 1019-1030.
- Babanyara, Y. 2013, "Poor Medical Waste Management (Mwm) Practices And its Risks to Human Health and the Environment: A Literature Review", *Waste Management*, .
- Bai, V.R., Vanitha, G. & Ariff, A.Z. 2013, "Effective Hospital Waste Classification to Overcome Occupational Health Issues and Reduce Waste Disposal Cost", *Infection Control and Hospital Epidemiology*, vol. 34, no. 11, pp. 1234-1235.

- Bala, S. & Narwal, A. 2013a, "Awareness of Bio-medical Waste Management Among Dental College and Hospital Employees-A Panoramic View.", *Journal of Oral Health & Community Dentistry*, vol. 7, no. 1.
- Bala, S. & Narwal, A. 2013b, "Awareness of Bio-medical Waste Management Among Dental College and Hospital Employees-A Panoramic View.", *Journal of Oral Health & Community Dentistry*, vol. 7, no. 1.
- Bartley, J.M., Olmsted, R.N. & Haas, J. 2010, "Current views of health care design and construction: Practical implications for safer, cleaner environments", *American Journal of Infection Control*, vol. 38, no. 5, pp. S1-S12.
- Berwick, D.M. & Hackbarth, A.D. 2012, "Eliminating waste in US health care", *JAMA: the journal of the American Medical Association*, vol. 307, no. 14, pp. 1513-1516.
- Blenkharn, J.I. 2009, "Sharps management and the disposal of clinical waste", *British Journal of Nursing*, vol. 18, no. 14, pp. 860-864.
- Bosmans, A., Vanderreydt, I., Geysen, D. & Helsen, L. 2012, "The crucial role of waste-to-energy technologies in enhanced landfill mining: a technology review", *Journal of Cleaner Production*, .
- Botelho, A. 2012, "The impact of education and training on compliance behavior and waste generation in European private healthcare facilities", *Journal of environmental management*, vol. 98, pp. 5-10.
- Brewer, B. & Antell, A. 2012, "A case study of the management of hazardous waste drugs in a large university hospital", *Journal of Chemical Health and Safety*, .
- Bryant, C. 2010, "Twenty-Five Years of EU Environmental Law", *Nat.Resources & Env't*, vol. 25, pp. 39.
- Budd, S. & Baker, K. 2013, "A practical approach to waste management", *Health estate*, vol. 67, no. 8, pp. 45-48.
- Byun, Y., Namkung, W., Cho, M., Chung, J.W., Kim, Y., Lee, J., Lee, C. & Hwang, S. 2010, "Demonstration of thermal plasma gasification/vitrification for municipal solid waste treatment", *Environmental science & technology*, vol. 44, no. 17, pp. 6680-6684.
- Chaerul, M., Tanaka, M. & Shekdar, A.V. 2008, "A system dynamics approach for hospital waste management", *Waste Management*, vol. 28, no. 2, pp. 442-449.
- Chakraborty, S., Veeregowda, B., Gowda, L., Sannegowda, S.N., Tiwari, R., Dhama, K. & Singh, S.V. 2013, "Biomedical Waste Management", *Interaction*, vol. 2013, pp. 12-02.

- Chen, D. 2013, "The Responsibility of Manufacturers and Importers with Regards to the Recycling, Clearance, and Disposal of Articles and Containers, and the Scope of Responsibility of Enterprises with Regards to Recycling, Clearance, and Disposal", .
- Cheng, Y.W., Sung, F.C., Yang, Y., Lo, Y., Chung, Y. & Li, K. 2009, "Medical waste production at hospitals and associated factors", *Waste Management*, vol. 29, no. 1, pp. 440-444.
- Cheng, Y., Li, K. & Sung, F. 2010, "Medical waste generation in selected clinical facilities in Taiwan", *Waste Management*, vol. 30, no. 8, pp. 1690-1695.
- Chung, S. 2013, "5. South Korea's approach to transboundary waste management: experiences and lessons learned", *International Trade in Recyclable and Hazardous Waste in Asia*, , pp. 72.
- Conrardy, J., Hillanbrand, M., Myers, S. & Nussbaum, G.F. 2010, "Reducing medical waste", *AORN Journal*, vol. 91, no. 6, pp. 711-721.
- Costa, I., Massard, G. & Agarwal, A. 2010, "Waste management policies for industrial symbiosis development: case studies in European countries", *Journal of Cleaner Production*, vol. 18, no. 8, pp. 815-822.
- Dale, A. & Robinson, J.B. 2011, *Achieving sustainable development*, UBC Press.
- De Sadeleer, N. 2013, *EU Environmental Law and the Internal Market*, Oxford University Press.
- Demirbas, A. 2011, "Waste management, waste resource facilities and waste conversion processes", *Energy Conversion and Management*, vol. 52, no. 2, pp. 1280-1287.
- DOHARE, S., GARG, V. & SARKAR, B. 2013, "A STUDY OF HOSPITAL WASTE MANAGEMENT STATUS IN HEALTH FACILITIES OF AN URBAN AREA.", *International Journal of Pharma & Bio Sciences*, vol. 4, no. 1.
- Eker, H.H. & Bilgili, M.S. 2011, "Statistical analysis of waste generation in healthcare services: a case study", *Waste Management & Research*, vol. 29, no. 8, pp. 791-796.
- Faisal, M.N., Khan, S. & Farooqi, I. 2010, "Analysis of interactions among the barriers to effective hospital waste management", *International Journal of Behavioural and Healthcare Research*, vol. 2, no. 2, pp. 154-171.
- Fu, F. & Wang, Q. 2011, "Removal of heavy metal ions from wastewaters: A review", *Journal of environmental management*, vol. 92, no. 3, pp. 407-418.
- Gautam, V., Thapar, R. & Sharma, M. 2010, "Biomedical waste management: Incineration vs. environmental safety", *Indian journal of medical microbiology*, vol. 28, no. 3, pp. 191.

- Hagen, D.L., Al-Humaidi, F. & Blake, M.A. 2001, "Infectious waste surveys in a Saudi Arabian hospital: an important quality improvement tool", *American Journal of Infection Control*, vol. 29, no. 3, pp. 198-202.
- Harhay, M.O., Halpern, S.D., Harhay, J.S. & Olliaro, P.L. 2009, "Health care waste management: a neglected and growing public health problem worldwide", *Tropical Medicine & International Health*, vol. 14, no. 11, pp. 1414-1417.
- Helsen, L. & Bosmans, A. 2010, "Waste-to-Energy through thermochemical processes: matching waste with process", *1 st International Symposium on Enhanced Landfill Mining, Houthalen-Helchteren*, pp. 4.
- Ho, C.C. & Liao, C. 2011, "The use of failure mode and effects analysis to construct an effective disposal and prevention mechanism for infectious hospital waste", *Waste Management*, vol. 31, no. 12, pp. 2631-2637.
- Hossain, M.S., Balakrishnan, V., Rahman, Nik Norulaini Nik Ab, Sarker, M.Z.I. & Kadir, M.O.A. 2012, "Treatment of Clinical Solid Waste Using a Steam Autoclave as a Possible Alternative Technology to Incineration", *International journal of environmental research and public health*, vol. 9, no. 3, pp. 855-867.
- Hossain, M.S., Rahman, Nik Norulaini Nik Ab, Balakrishnan, V., Puvanesuaran, V.R., Sarker, M.Z.I. & Kadir, M.O.A. 2013, "Infectious Risk Assessment of Unsafe Handling Practices and Management of Clinical Solid Waste", *International journal of environmental research and public health*, vol. 10, no. 2, pp. 556-567.
- Hossain, M.S., Santhanam, A., Nik Norulaini, N. & Omar, A. 2011a, "Clinical solid waste management practices and its impact on human health and environment—A review", *Waste Management*, vol. 31, no. 4, pp. 754-766.
- Hossain, M.S., Santhanam, A., Nik Norulaini, N. & Omar, A. 2011b, "Clinical solid waste management practices and its impact on human health and environment—A review", *Waste Management*, vol. 31, no. 4, pp. 754-766.
- Hossain, M.S., Santhanam, A., Nik Norulaini, N. & Omar, A. 2011c, "Clinical solid waste management practices and its impact on human health and environment—A review", *Waste Management*, vol. 31, no. 4, pp. 754-766.
- Insa, E., Zamorano, M. & López, R. 2010, "Critical review of medical waste legislation in Spain", *Resources, Conservation and Recycling*, vol. 54, no. 12, pp. 1048-1059.
- Kang, Y., Jeon, T., Kim, W., Shin, S.K., Yeon, J. & Somasundaram, S. 2013, "Correlation study of hazardous waste characteristics among various chemical processes in Republic of Korea", *Journal of Material Cycles and Waste Management*, , pp. 1-10.

- Kawai, Y., Ikegami, H., Sato, N., Matsuda, A., Uchino, K. & Kuzuya, M. 2010, *Industrial Plasma Technology*, John Wiley & Sons.
- Komilis, D. & Katsafaros, N. 2011, "Statistical predictors of hazardous medical waste generation rates in a 40-bed general hospital", *Global NEST Journal*, vol. 13, no. 2, pp. 170-175.
- Komilis, D., Fouki, A. & Papadopoulos, D. 2012a, "Hazardous medical waste generation rates of different categories of health-care facilities", *Waste Management*, vol. 32, no. 7, pp. 1434-1441.
- Komilis, D., Fouki, A. & Papadopoulos, D. 2012b, "Hazardous medical waste generation rates of different categories of health-care facilities", *Waste Management*, vol. 32, no. 7, pp. 1434-1441.
- Komilis, D., Fouki, A. & Papadopoulos, D. 2012c, "Hazardous medical waste generation rates of different categories of health-care facilities", *Waste Management*, vol. 32, no. 7, pp. 1434-1441.
- Kumar, P.S., Dhanapal, C., Ravi, S., Rao, K. & Manavalan, R. 2011, "PREVENTION AND CONTROL OF INFECTIONS.", *International Journal of Pharma & Bio Sciences*, vol. 2, no. 1.
- Lancaster, M. 2010, *Green chemistry*, Royal Society of Chemistry.
- Li, X., Yan, M., Yang, J., Chen, T., Lu, S. & Yan, J. 2012, "PCDD/Fs in soil around a hospital waste incinerator: comparison after three years of operation", *Journal of Environmental Sciences*, vol. 24, no. 4, pp. 699-703.
- Llatas, C. 2011, "A model for quantifying construction waste in projects according to the European waste list", *Waste Management*, vol. 31, no. 6, pp. 1261-1276.
- Lu, J., Chang, N. & Liao, L. 2012, "Environmental Informatics for Solid and Hazardous Waste Management: Advances, Challenges, and Perspectives", *Critical Reviews in Environmental Science and Technology*, , no. just-accepted.
- Mahmoud, M.S.A. & Abdalla, S.M.A. 2013, "Development of Local health Care Planning and Demanding in Saudi Arabia By Using GIS Applications", *International Journal of Computer Science and Engineering*, .
- Manyele, Samuel V. 2004, " Medical Waste Management in Tanzania: Current Situation and The Way Forward", *African Journal of Environmental Assessment and Management*, Vol. 8, pp.74-99.
- Mathur, P. 2014, "Role of Hospital Housekeeping and Materials Management Including Disinfection and Waste Management" in *Hospital Infection Prevention* Springer, , pp. 81-89.



- Memish, Z.A. & Al-Rabeeah, A.A. 2013, "Public health management of mass gatherings: the Saudi Arabian experience with MERS-CoV", *Bulletin of the World Health Organization*, vol. 91, no. 12, pp. 899-899A.
- Min, D. & Rhee, S. 2014, "Management of Municipal Solid Waste in Korea" in *Municipal Solid Waste Management in Asia and the Pacific Islands* Springer, , pp. 173-194.
- Mohan, D.R., Prasad, M.V. & Kumar, K.S. 2012, "Impact of training on bio medical waste management—A study and analysis", *International journal of multidisciplinary management studies*, 6june, vol. 2, no. 6.
- Mufti, M.H. 2000, *Healthcare development strategies in the Kingdom of Saudi Arabia*, Springer.
- Mühlich, M., Scherrer, M. & Daschner, F. 2003, "Comparison of infectious waste management in European hospitals", *Journal of Hospital Infection*, vol. 55, no. 4, pp. 260-268.
- Neyaz, Y., Khoja, T., Qureshi, N., Magzoub, M., Haycox, A. & Walley, T. 2011a, "Medication prescribing pattern in primary care in Riyadh city, Saudi Arabia", *EMHJ*, vol. 17, no. 2.
- Neyaz, Y., Qureshi, N., Khoja, T., Magzoub, M., Haycox, A. & Walley, T. 2011b, "Physicians' medication prescribing in primary care in Riyadh city, Saudi Arabia. Literature review, part 1: variations in drug prescribing", *EMHJ*, vol. 17, no. 2.
- Pandelova, M., Stanev, I., Henkelmann, B., Lenoir, D. & Schramm, K. 2009, "Correlation of PCDD/F and PCB at combustion experiments using wood and hospital waste. Influence of (NH<sub>4</sub>)<sub>2</sub>SO<sub>4</sub> as additive on PCDD/F and PCB emissions.", *Chemosphere*, vol. 75, no. 5, pp. 685-691.
- Pant, D. 2012, "Waste management in small hospitals: trouble for environment", *Environmental monitoring and assessment*, vol. 184, no. 7, pp. 4449-4453.
- Pariatamby, A. & Fauziah, S. 2014, "Sustainable 3R Practice in the Asia and Pacific Regions: The Challenges and Issues" in *Municipal Solid Waste Management in Asia and the Pacific Islands* Springer, , pp. 15-40.
- Patwary, M.A., O'Hare, W.T. & Sarker, M. 2011a, "An illicit economy: Scavenging and recycling of medical waste", *Journal of environmental management*, vol. 92, no. 11, pp. 2900-2906.
- Patwary, M.A., O'Hare, W.T. & Sarker, M.H. 2011b, "Assessment of occupational and environmental safety associated with medical waste disposal in developing countries: a qualitative approach", *Safety Science*, vol. 49, no. 8, pp. 1200-1207.
- Pichtel, J. 2010a, *Waste management practices: municipal, hazardous, and industrial*, CRC Press.

- Pichtel, J. 2010b, *Waste management practices: municipal, hazardous, and industrial*, CRC Press.
- Pichtel, J. 2010c, *Waste management practices: municipal, hazardous, and industrial*, CRC Press.
- Pires, A., Martinho, G. & Chang, N. 2011a, "Solid waste management in European countries: a review of systems analysis techniques", *Journal of environmental management*, vol. 92, no. 4, pp. 1033-1050.
- Pires, A., Martinho, G. & Chang, N. 2011b, "Solid waste management in European countries: a review of systems analysis techniques", *Journal of environmental management*, vol. 92, no. 4, pp. 1033-1050.
- Prem Ananth, A., Prashanthini, V. & Visvanathan, C. 2010, "Healthcare waste management in Asia", *Waste Management*, vol. 30, no. 1, pp. 154-161.
- Prüss, A., Emmanuel, J., Stringer, R., Pieper, U., Townend, W., Wilburn, S., Chantier, Y. & World Health Organization 2013, "Safe management of wastes from health-care activities/edited by A. Prüss...[et al]", .
- Rastogi, V., Rastogi, P. & Bhatia, S. 2011, "Bacteriological profile of biomedical waste: Management guidelines.", .
- Richards, E. & Haynes, D. 2014, "Solid Waste Management in Pacific Island Countries and Territories" in *Municipal Solid Waste Management in Asia and the Pacific Islands* Springer, , pp. 255-279.
- Sakai, S., Yoshida, H., Hirai, Y., Asari, M., Takigami, H., Takahashi, S., Tomoda, K., Peeler, M.V., Wejchert, J. & Schmid-Unterseh, T. 2011, "International comparative study of 3R and waste management policy developments", *Journal of Material Cycles and Waste Management*, vol. 13, no. 2, pp. 86-102.
- Saner, D., Blumer, Y.B., Lang, D.J. & Koehler, A. 2011, "Scenarios for the implementation of EU waste legislation at national level and their consequences for emissions from municipal waste incineration", *Resources, Conservation and Recycling*, vol. 57, pp. 67-77.
- Scheinberg, A. & Mol, A.P. 2010, "Multiple modernities: transitional Bulgaria and the ecological modernisation of solid waste management", *Environment and planning.C, Government & policy*, vol. 28, no. 1, pp. 18.
- Schwartz, R.N., Eng, K.J., Frieze, D.A., Gosselin, T.K., Griffith, N., Seung, A.H., Hinkel, J.M., Johnson, P.E., Johnson, S.A. & Li, E.C. 2010, "NCCN Task Force report: specialty pharmacy", *Journal of the National Comprehensive Cancer Network*, vol. 8, no. Suppl 4, pp. S-1-S-12.

- Selin, H. & VanDeveer, S.D. 2006, "Raising global standards: hazardous substances and e-waste management in the European Union", *Environment: Science and Policy for Sustainable Development*, vol. 48, no. 10, pp. 6-18.
- Sharma, P., Kumar, M., Mathur, N., Singh, A., Bhatnagar, P. & Sogani, M. 2013, "Health care industries: potential generators of genotoxic waste", *Environmental Science and Pollution Research*, , pp. 1-8.
- Shereif, M.M. and Al-Shallash, K.S. (2007). Healthcare Waste Management in Saudi Arabia. A caseStudy. Accepted for Presentation Session at the International Conference on Environment: Survival and sustainability, Greece, 19-24 July, 2007.
- Silva, A.N., Mota, E.A., Costa, E.A. & Reis, M.G. 2013, "Wastes from Health-Care, Pathogenic Microorganisms, Environmental Factors and Disinfection Processes: conceptual evolution and environmental education", .
- Taher, N. & Hajjar, B. 2014, "Environmental Challenges, Regulations and Institutions in Saudi Arabia" in *Energy and Environment in Saudi Arabia: Concerns & Opportunities* Springer, , pp. 1-26.
- Therivel, R. 2012, *Strategic environmental assessment in action*, Routledge.
- Tsakona, M., Anagnostopoulou, E. & Gidarakos, E. 2007, "Hospital waste management and toxicity evaluation: a case study", *Waste Management*, vol. 27, no. 7, pp. 912-920.
- Tudor, T.L. 2011, "Overcoming attitudes and perceptions towards the management of infections and waste in the hospital setting: a case study from the UK", *International Journal of Behavioural and Healthcare Research*, vol. 2, no. 4, pp. 307-319.
- Tudor, T.L., Woolridge, A.C., Phillips, C., Holliday, M., Laird, K., Bannister, S., Edgar, J. & Rushbrook, P. 2010, "Evaluating the link between the management of clinical waste in the National Health Service (NHS) and the risk of the spread of infections: A case study of three hospitals in England", *International journal of hygiene and environmental health*, vol. 213, no. 6, pp. 432-436.
- Wen, X., Luo, Q., Hu, H., Wang, N., Chen, Y., Jin, J., Hao, Y., Xu, G., Li, F. & Fang, W. 2013a, "Comparison research on waste classification between China and the EU, Japan, and the USA", *Journal of Material Cycles and Waste Management*, , pp. 1-14.
- Wen, X., Luo, Q., Hu, H., Wang, N., Chen, Y., Jin, J., Hao, Y., Xu, G., Li, F. & Fang, W. 2013b, "Comparison research on waste classification between China and the EU, Japan, and the USA", *Journal of Material Cycles and Waste Management*, , pp. 1-14.

- West, C., Borzuchowska, J. & Ferreira, A. 2011, "SEA Implementation and Practice: Making an Impact? Prague, Czech Republic 21-23 September 2011 SEA application in UK, Poland and Portugal–A consultant's perspective", *SEA*, vol. 21, pp. 23.
- Zhang, D.Q., Tan, S.K. & Gersberg, R.M. 2010, "Municipal solid waste management in China: Status, problems and challenges", *Journal of environmental management*, vol. 91, no. 8, pp. 1623-1633.
- Zhang, Q., Dor, L., Fenigshtein, D., Yang, W. & Blasiak, W. 2012, "Gasification of municipal solid waste in the Plasma Gasification Melting process", *Applied Energy*, vol. 90, no. 1, pp. 106-112.
- Zhao, L., Zhang, F., Chen, M., Liu, Z. & Wu, D.B.J. 2010, "Typical pollutants in bottom ashes from a typical medical waste incinerator", *Journal of hazardous materials*, vol. 173, no. 1, pp. 181-185.

## **Appendices**

## **Appendix A**

# **MEDICAL WASTE MANAGEMENT SURVEY HOSPITALS, CLINICS**

Please Return to: Abdullah

P.O. Box 29752

### **I. General Information**

1. Name of Respondent:

Name of Organization:

City:

2. Facility Type (check one):

ministry of health       university Hospital

Private Hospital       primary care

military hospital       private clinic

others please Specify. .

3. Which of the following best describes your facility's activities (check one):

<input type="radio"/> General Medical & Surgical Rehabilitation Chronic Disease	<input type="radio"/> Psychiatric	<input type="radio"/> OBIGYN	<input type="radio"/>
	<input type="radio"/> Eye, Ear, Nose & Throat	<input type="radio"/> Orthopaedic	<input type="radio"/>
	<input type="radio"/> Others, Please Specify:		

## II. Activity Measures

1. Number of patients administered to on a monthly basis:

2. If applicable, number of beds in your facility:

3. If applicable, percent bed occupancy at your facility during an average month:

4. If applicable, number of outpatients treated at your facility during an average month:

III. Wastes Generated %

1. Total amount of waste generated by your facility in an “average” month (please express in Kilograms): Kg

2. Amount of waste that can be considered medical waste as described in A-H below: Kg

3. Please provide best estimates of what percentage of total medical waste generated by your facility can be categorized as:

A. Cultures and stocks of infectious agents and .associated biological %

8. Blood, blood products arid body fluids (other than urine) at least 20 cc of Quid volume per vessel %

C. Pathological wastes consisting of tissues, organs, body parts (including products of conception) which are discarded after surgery, obstetrical procedures, and autopsy and laboratory procedures %

D. Needles and syringes or other laboratory articles (sharps) that might cause punctures or cuts including intravenous tubing with needles attached, vacuum collection containers/tubes containing blood, slides, etc. %

E. Carcasses, body parts and bedding of all research animals that were intentionally exposed to pathogens %

F. Solid wastes generated from rare, unusual or special cases involving highly communicable diseases %

G. Wastes generated as a result of renal dialysis, including tubing and needles  
%

H. Other discarded materials associated with patient care, e.g. disposable diagnostic supplies  
%

4. If possible select the five wards (e.g. emergency, OB/GYN) that generate the most medical waste ( given in categories A through H above). Also provide, if known, the percentage of total medical waste generated in these five wards.

a. Name of first ward: Percentage of total:

b. Name of second ward: Percentage of total:

c. Name of third ward: Percentage of total:

d. Name of: fourth ward: Percentage of total:

e. Name of fifth ward: Percentage of total:

#### IV. Treatment, Transportation and Disposal

11 Do you segregate medical waste from general? Refuse prior to treatment and disposal-

Yes

No



2. If yes, which medical wastes (categories A through H in section III) do you segregate from general refuse?

O A O B O C O D O E O F O G O H O All

3. Estimate the percentage of the total medical waste (defined in section III) that are treated in the following manner.

a. Treated on-site in incinerators:

\_\_\_\_\_ %

b. Treated on-site in autoclaves:

\_\_\_\_\_ %

c. Treated off-site at a commercial treatment facility:

\_\_\_\_\_ %

d. Disposed of in sanitary landfills without treatment:

\_\_\_\_\_ %

e. Discharged to your facility's sewer system:

\_\_\_\_\_ %

f. Others, Please specify:

\_\_\_\_\_ %

4. If your facility treats medical waste on site, at what percent capacity are the following

units operating?

a. Incinerators are operating at  
\_\_\_\_\_ %

of a Total incinerator capacity of  
\_\_\_\_\_ Kg/hrs

b. Autoclaves are operating at  
\_\_\_\_\_ %

of a Total capacity of  
\_\_\_\_\_ Kg/hrs

5. On an average, how much do you pay for transportation and treatment/disposal of wastes your facility considers as medical waste?

Total costs:  
\_\_\_\_\_ /month

Cost on a per Kg basis  
\_\_\_\_\_ /Kg

If known, please provide the transportation and disposal/treatment costs separately

Total waste transportation cost  
SR \_\_\_\_\_ /month

Total disposal/treatment cost  
SR \_\_\_\_\_ /month

6. Please provide the names and addresses of the medical waste transporters that service your facility:

---

---

---

---

7 if known, please provide the name and city of the treatment and disposal

Facilities that service your facility:

---

---

---

---

8. How do you treat biologically hazardous radioactive waste?

---

---

---

V. Regulations:

1. in the area where your facility is located medical wastes are regulated by:

Municipal regulations                       County regulations

OTHER SPECIFY                       EPA regulations

2. Which regulation hinders the disposal process?

Municipal regulations                       County regulations

OTHER SPECIFY

EPA regulations

Please specify what that regulation is (attach a copy of the regulation if possible):

---

---

---

---

VI. Recommendations:

1. Would you prefer a uniform worldwide regulation or prefer local control?

Allow Local Regulations

Allow only word wide Regulations

2. What are your recommendations regarding medical waste disposal problems?

---

---

---

---

---

---

---

# **MEDICAL WASTE MANAGEMENT SURVEY**

## **DOCTORS, DENTISTS**

Please Return to:

### **I. General Information:**

1. Name of Respondent:

City:

2. Profession (check one):

Doctor

Dentist

Your Speciality:

3. Are you part of a group practice?

Yes

No

.

If yes, how many practitioners are there in the group?

\_\_\_\_\_

Are you answering this form for the group?

Yes

No

## II. Activity Measures

1. How many patients do you see per month?

2. If you are a doctor, about how many blood samples do you take per month?

3. If you are a doctor, approximately what percent of the blood samples taken per month are analyzed off-site?



C. Pathological wastes consisting of tissues, organs, body parts (including products of conception) which are discarded after surgery, obstetrical procedures, and autopsy and laboratory procedures %

D-Needles and syringes or other laboratory articles (sharps) that might cause punctures or cuts including

Intravenous tubing with needles attached, vacuum collection containers/tubes containing blood, slides, etc. %

E-Carcasses, body parts and bedding of all research animals that were intentionally exposed to pathogens

F-Solid wastes generated from rare, unusual or special cases involving highly communicable diseases

G-Wastes generated as a result of renal dialysis, including tubing and needles

H-Other discarded materials associated with patient care, e.g. disposable diagnostic supplies, cotton balls etc.

#### IV. Transportation and Disposal

1. Do you segregate medical waste from general refuse prior to treatment and disposal?

Yes

O No



If yes, which of the following do you segregate

Sharps                       Pathological Wastes

Blood contaminated supplies               Others, Please Specify:

2. Your medical waste is transported to treatment/disposal facility by:

Medical waste hauler               Others, Please specify

3. Do you treat or dispose of any of your medical wastes on site'?

YES                       No

If yes, which medical wastes (categories A through H in section III) do you treat/dispose?

A    B    C    D    E    F    G    H    All

By what method?

incinerate    Autoclave

clip sharps/box    Wash down the sewer

Others, Please specify

4. On an average, how much do you pay on a monthly basis for medical waste transportation and treatment/disposal services?

Total costs:

Cost on a per kg basis

SR /month

SR /KG

if known, please provide the transportation and disposal/treatment costs separate-Iy

Total waste transportation cost

Total disposal/treatment cost

SR /month

SR /month

5. Please provide the names and addresses of the medical waste transporters that service your facility:

6. If known, please provide the name and city of the treatment and disposal facilities used by your medical waste hauler:

V. Regulations:

1. In the area where your office is located medical wastes are regulated by:

Municipal regulations                       County regulations

WORLD WIDE regulations                       EPA regulations

OTHERS SPECIFY

2. Which regulation hinders the disposal process?

Municipal regulations                       County regulations

WORLD WIDE regulations                       EPA regulations

OTHERS SPECIFY

Please specify what that regulation is (attach a copy of the regulation if possible):

VI. Recommendations:

1. Would you prefer a uniform world wide regulation or prefer local control?

Allow Local Regulations                       Allow only world wide Regulations

2. What are your recommendations regarding medical waste disposal?

## Appendix B

### Questionnaires

#### Section A: General Information

- Your **current job title**.....
- Name of your department.....
- Qualification.....
- Country of graduation .....
- Year of graduation .....
- How concerned are you with medical waste management?  
Highly concerned    slightly concerned    Neutral    Not concerned

**Section B:** please answer the following:

1. **Have you studied any waste management subject in your graduation/ university level?**  
1. Yes            2. No
2. **Have you attend any training on waste management?**  
1. Yes            2. No
3. **Do you think some staff might put waste in wrong bin?**  
1. Yes            2. No
4. **Does your department offers any training to all staff on waste management?**  
1. Yes            2. No
5. **Does your department offer waste bins colour coding system?**  
1. Yes            2. No
6. **Do you think your department does enough awareness campaigns related to medical waste management?**  
1. Yes            2. No
7. **Does your department have apply any monitoring or control system related to waste management?**  
1. Yes            2. No
8. **Does your department take any against Mismanagement of mishandling of medical waste?**  
1. Yes            2. No
9. **Does your department employee specialise staff responsible for medical waste management?**  
1. Yes            2. No
10. **Are you aware of any national framework or policy related to medical waste management in Saudi?**  
1. Yes            2. No
11. **Do you think there is a gap between Saudi and developing countries in how waste management treated?**  
1. Yes            2. No
12. **Do you think there is need for more investment on factories for recycling of medical waste?**  
1. Yes            2. No

**Section C:** In the following section, please indicate to what extent you agree or disagree the following statements regarding on scale of 5 (1=strongly agree, 2=Agree, 3=Neutral, 4=disagree and 5=strongly disagree), please answer the following questions based on your own opinions and experience (circle the appropriate number).

**1. There is a need of a special course/module in healthcare subject about medical waste management at graduation/university level?**

Strongly Agree 1    Agree 2    Neutral 3    Disagree 4    Strongly Disagree 5

**2. Staff members should have specific training on medical waste management.**

Strongly Agree 1    Agree 2    Neutral 3    Disagree 4    Strongly Disagree 5

**3. I believe it will be effective if mosques/imams help to promote health risks related to medical waste for community awareness part of Friday prayer ( Kwtabah ) ?**

Strongly Agree 1    Agree 2    Neutral 3    Disagree 4    Strongly Disagree 5

**4. There is a need of implementing uniform national policies for the medical waste management in hospitals in Saudi Arabia ?**

Strongly Agree 1    Agree 2    Neutral 3    Disagree 4    Strongly Disagree 5

**5. I believe Mismanagement and mishandling of medical waste should be taken legally?**

Strongly Agree 1    Agree 2    Neutral 3    Disagree 4    Strongly Disagree 5

**6. There Is a need for separate independent monitoring and controlling authority for medical waste management in Saudi Arabia?**

Strongly Agree 1    Agree 2    Neutral 3    Disagree 4    Strongly Disagree 5

**7. Some members of Staff should be specialized and trained in handling and treatment methods of medical waste.**

Strongly Agree 1    Agree 2    Neutral 3    Disagree 4    Strongly Disagree 5

**8. Medical research centres and academic institutions must be involve to identify and recommends the state of art technologies for waste management.**

Strongly Agree 1    Agree 2    Neutral 3    Disagree 4    Strongly Disagree 5

**9. Government should encourage investors to invest in medical waste management recycling business.**

Strongly Agree 1    Agree 2    Neutral 3    Disagree 4    Strongly Disagree 5

## **Appendix C**